



ICS-1000 ION CHROMATOGRAPHY SYSTEM OPERATOR'S MANUAL

Now sold under the
Thermo Scientific brand

Thermo
S C I E N T I F I C

Document No. 031879
Revision 02
September 2005

©2005 by Dionex Corporation
All rights reserved worldwide.
Printed in the United States of America.

This publication is protected by federal copyright law. No part of this publication may be copied or distributed, transmitted, transcribed, stored in a retrieval system, or transmitted into any human or computer language, in any form or by any means, electronic, mechanical, magnetic, manual, or otherwise, or disclosed to third parties without the express written permission of Dionex Corporation, 1228 Titan Way, Sunnyvale, California 94088-3603 U.S.A.

DISCLAIMER OF WARRANTY AND LIMITED WARRANTY

THIS PUBLICATION IS PROVIDED “AS IS” WITHOUT WARRANTY OF ANY KIND. DIONEX CORPORATION DOES NOT WARRANT, GUARANTEE, OR MAKE ANY EXPRESS OR IMPLIED REPRESENTATIONS REGARDING THE USE, OR THE RESULTS OF THE USE, OF THIS PUBLICATION IN TERMS OF CORRECTNESS, ACCURACY, RELIABILITY, CURRENTNESS, OR OTHERWISE. FURTHER, DIONEX CORPORATION RESERVES THE RIGHT TO REVISE THIS PUBLICATION AND TO MAKE CHANGES FROM TIME TO TIME IN THE CONTENT HEREINOF WITHOUT OBLIGATION OF DIONEX CORPORATION TO NOTIFY ANY PERSON OR ORGANIZATION OF SUCH REVISION OR CHANGES.

TRADEMARKS

AES, Atlas, Chromeleon, EluGen, IonPac, OnGuard, and SRS are registered trademarks of Dionex Corporation. CarboPac, MicroMembrane, MMS, Reagent-Free, and RFIC are trademarks of Dionex Corporation.

Acrobat, Adobe, and Adobe Reader, are registered trademarks of Adobe Systems, Incorporated.

PEEK is a trademark of Victrex PLC.

Teflon is a registered trademark of E.I. duPont de Nemours & Company.

Microsoft and Windows are registered trademarks of Microsoft Corporation.

PRINTING HISTORY

Revision 01, March 2003

Revision 02, September 2005

1 • Introduction

1.1	Introduction to Ion Chromatography (IC)	1-1
1.2	Overview of the ICS-1000	1-4
1.3	About This Manual	1-5
1.3.1	Safety Messages and Notes	1-6
1.3.2	Safety Labels	1-8

2 • Features

2.1	Operating Features	2-1
2.1.1	Front Panel	2-1
2.1.2	Top Cover	2-3
2.1.3	Component Panel	2-4
2.1.4	Rear Panel	2-7
2.2	Flow Schematic	2-9
2.3	The Chromeleon Interface	2-11
2.3.1	The Chromeleon Main Window and Browser	2-12
2.3.2	The ICS-1000 Control Panels	2-13
2.4	System Component Details	2-19
2.4.1	Vacuum Degas Assembly (Optional)	2-19
2.4.2	Eluent Valve	2-21
2.4.3	Pump	2-21

2.4.4	Injection Valve	2-24
2.4.5	Column Heater (Optional)	2-26
2.4.6	Suppressor	2-26
2.4.7	DS6 Heated Conductivity Cell	2-27

3 • Operation and Maintenance

3.1	Operation Overview	3-1
3.2	Power Up the System	3-3
3.3	Start Chromeleon	3-4
3.4	Set Up the Eluent Reservoir	3-6
3.4.1	Prepare the Eluent	3-6
3.4.2	Degas the Eluent	3-6
3.4.3	Filter the Eluent	3-7
3.4.4	Fill the Reservoir	3-7
3.4.5	Set the Eluent Level	3-8
3.4.6	Connect the Reservoir	3-8
3.5	Check All Connections	3-8
3.6	Prime the Pump	3-9
3.7	Set System Operating Conditions	3-10
3.8	Equilibrate the System and Verify Operational Status	3-10
3.9	Prepare Samples	3-11
3.9.1	Collecting and Storing Samples	3-11
3.9.2	Pretreating Samples	3-12
3.9.3	Diluting Samples	3-12

3.10 Loading and Injecting Samples3-13

3.10.1 Loading Samples with a Syringe3-14

3.10.2 Loading Samples with a Vacuum Syringe3-14

3.10.3 Loading Samples with an Autosampler3-15

3.10.4 Injecting Samples3-16

3.10.5 Example Chromeleon Commands for Loading and
Injecting Samples3-16

3.11 Process Samples3-17

3.11.1 Manual Sample Processing3-17

3.11.2 Automatic (Batch) Sample Processing3-18

3.12 Maintenance3-20

4 • Troubleshooting

4.3 Error Messages4-1

4.1 Troubleshooting Error Messages4-3

4.2 Liquid Leaks4-9

4.3 Pump Difficult to Prime or Loses Prime4-11

4.4 Pump Does Not Start4-13

4.5 No Flow4-14

4.6 Erratic Flow/Pressure Reading4-15

4.7 Excessive System Backpressure4-15

4.8 Peak “Ghosting”4-16

4.9 Nonreproducible Peak Height or Retention Time4-17

4.10 Abnormal Retention Time or Selectivity4-17

4.11 No Cell Response4-18

4.12	High Cell Output	4-18
4.13	Baseline Noise or Drift	4-19
4.14	Vacuum Degas Assembly Does Not Run	4-20

5 • Service

5.1	Diagnostic and Calibration Procedures	5-1
5.1.1	Chromleon Wellness Panel Overview	5-2
5.1.2	Calibrating the Conductivity Cell	5-4
5.1.3	Calibrating the Flow Rate	5-6
5.1.4	Calibrating the Vacuum Degas Assembly	5-7
5.2	Isolating a Restriction in the Liquid Lines	5-7
5.3	Replacing Tubing and Fittings	5-9
5.4	Rebuilding the Injection Valve	5-10
5.5	Cleaning and Replacing the Pump Check Valves	5-11
5.6	Replacing a Pump Piston Seal and Piston Rinse Seal	5-13
5.7	Replacing a Pump Piston	5-17
5.8	Replacing the Waste Valve or Priming Valve O-Ring	5-18
5.9	Replacing the Conductivity Cell	5-20
5.10	Replacing the Suppressor	5-22
5.11	Replacing the Column Heater	5-23
5.12	Replacing the Column Heater Heat Exchanger	5-25
5.13	Replacing the Eluent Valve	5-26
5.14	Replacing the Leak Sensor	5-28
5.15	Priming the Pump with Isopropyl Alcohol	5-29

5.16 Changing Main Power Fuses5-30

A • Specifications

A.1 Electrical A-1
A.2 Physical A-1
A.3 Environmental A-1
A.4 Front Panel A-2
A.5 Pump A-2
A.6 Detector A-3
A.7 Conductivity Cell with Heat Exchanger A-3
A.8 Injection Valve A-3
A.9 Vacuum Degas Assembly (Optional) A-3
A.10 Column Heater (Optional) A-4

B • Installation

B.1 Facility Requirements B-1
B.2 Unpacking the ICS-1000 System B-2
 B.2.1 Unpacking the Computer (North America only)..... B-4
 B.2.2 Unpacking the Computer (outside North America) B-4
B.3 Installing Chromeleon B-5
B.4 Installing the Chromeleon Software License B-6
B.5 Connecting the ICS-1000 to the Chromeleon PC B-9
 B.5.1 Connecting the ICS-1000 to the PC B-9
 B.5.2 Connecting Additional USB Devices B-10

ICS-1000 Ion Chromatography System

B.6	Connecting the Power Cord	B-11
B.7	Turning On the ICS-1000 Power	B-12
B.8	Setting Up Chromeleon	B-14
B.8.1	Assigning the ICS-1000 to a Timebase	B-14
B.8.2	Assigning DX-LAN Devices to the Timebase (Optional) ..	B-19
B.9	Installing and Plumbing the Columns and Suppressor	B-22
B.9.1	Setting Up the Column Heater (Optional)	B-22
B.9.2	Installing the Columns	B-23
B.9.3	Installing the Suppressor	B-24
B.10	Connecting the Waste Lines	B-26
B.10.1	Installing the Gas Separator Waste Tube	B-26
B.11	Setting Up the Eluent Reservoir	B-28
B.12	Setting Up a Chromeleon Application	B-29
B.12.1	Verifying Chromeleon Communication	B-38
B.13	Setting the Eluent Level	B-39
B.14	Priming the Pump	B-40
B.14.1	Priming the Eluent Lines with a Syringe	B-40
B.14.2	Priming with the Prime Button	B-42
B.15	Equilibrating the System	B-43
B.16	Verifying Operational Status	B-43
B.17	Connecting an AS or AS50 (USB) Autosampler (Optional)	B-44
B.17.1	AS or AS50 (USB) Connections	B-45
B.17.2	AS or AS50 (USB) Chromeleon Setup	B-47
B.18	Connecting an AS40 Automated Sampler (Optional)	B-48
B.19	Analog Output Connection (Optional)	B-50

B.20 Pressurizing the Eluent Reservoir (Optional) B-50
 B.20.1 Connecting the Gas Source (Optional) B-50
 B.20.2 Pressurizing the Eluent Reservoir (Optional) B-52
B.21 Pump Continuous Seal Wash Connections (Optional) B-53
B.22 Manually Connecting to a Control Panel B-55
B.23 Installation Troubleshooting B-57

C • TTL and Relay Control

C.1 TTL and Relay Connections C-1
 C.1.1 Selecting TTL Input Functions and Control Types. C-3
C.2 Controlling TTL and Relay Outputs C-5

D • Reordering Information

E • FAQ

E.1 How do I hook up an autosampler? E-1
E.2 How do I print? E-1
E.3 Why are the retention times moving? E-1
E.4 How do I adjust retention times? E-1
E.5 When should I remake standards? E-1
E.6 When should I remake eluents? E-2
E.7 How do I start Chromeleon? E-2
E.8 How do I delete data? E-2
E.9 How do I back up data? E-2

E.10	How do I shut off the system?	E-2
E.11	How do I store columns?	E-2
E.12	How do I know when a column is dirty?	E-2
E.13	How do I clean a column?	E-3
E.14	Why is the conductivity high?	E-3

F • Glossary

1.1 Introduction to Ion Chromatography (IC)

The Dionex ICS-1000 Ion Chromatography System (ICS-1000) performs ion analyses using suppressed or non-suppressed conductivity detection. An ion chromatography system typically consists of a liquid eluent, a high-pressure pump, a sample injector, a guard and separator column, a chemical suppressor, a conductivity cell, and a data collection system.

Before running a sample, the ion chromatography system is calibrated using a standard solution. By comparing the data obtained from a sample to that obtained from the known standard, sample ions can be identified and quantitated. The data collection system, typically a computer running chromatography software, produces a chromatogram (a plot of the detector output vs. time). The chromatography software converts each peak in the chromatogram to a sample concentration and produces a printout of the results.

A typical IC analysis consists of six stages (see [Figure 1-1](#)).

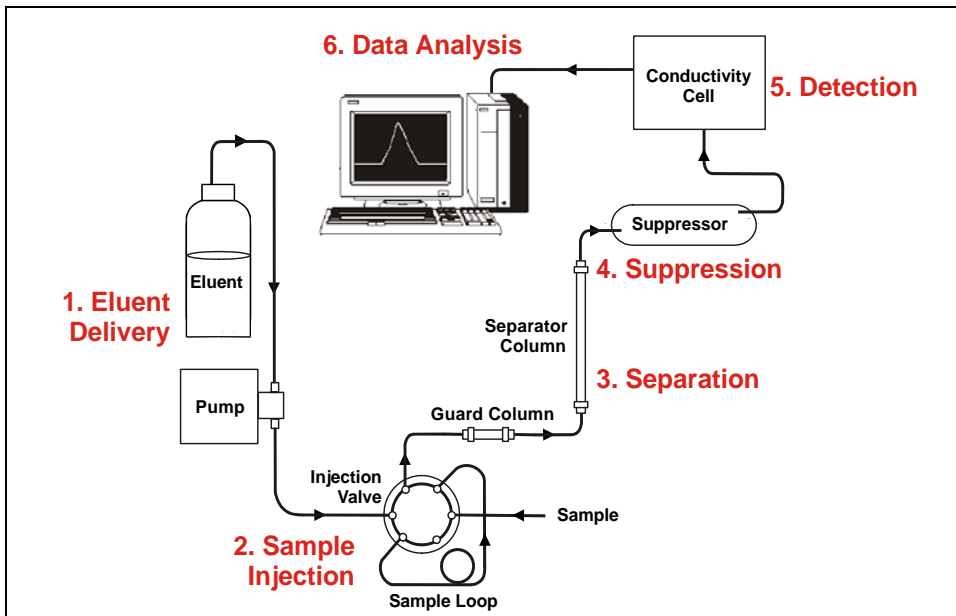

Figure 1-1. Ion Analysis Process

1. Eluent Delivery

- Eluent, a liquid that helps to separate the sample ions, carries the sample through the ion chromatography system. The ICS-1000 is an isocratic delivery system. This means that the eluent composition and concentration remain constant throughout the run.

2. Chromatography Management System Sample Injection

- The liquid sample is loaded into a sample loop either manually or automatically (if an automated sampler is installed). When triggered, the ICS-1000 injects the sample into the eluent stream.
- The pump pushes the eluent and sample through the guard and separator columns (chemically-inert tubes packed with a polymeric resin). The guard column removes contaminants that might poison the separator column.

3. Separation

- As the eluent and sample are pumped through the separator column, the sample ions are separated. In the ICS-1000, the mode of separation is called ion exchange. This is based on the premise that different sample ions migrate through the IC column at different rates, depending upon their interactions with the ion exchange sites.

4. Suppression

- After the eluent and sample ions leave the column, they flow through a suppressor that selectively enhances detection of the sample ions while suppressing the conductivity of the eluent.

5. Detection

- A conductivity cell measures the electrical conductance of the sample ions as they emerge from the suppressor and produces a signal based on a chemical or physical property of the analyte.

6. Data Analysis

- The conductivity cell transmits the signal to a data collection system.
- The data collection system (for the ICS-1000, this is Chromeleon) identifies the ions based on retention time, and quantifies each analyte by integrating the peak area or peak height. The data is quantitated by comparing the sample peaks in a chromatogram to those produced from a standard solution. The results are displayed as a chromatogram and the concentrations of ionic analytes can be automatically determined and tabulated.

1.2 Overview of the ICS-1000

The ICS-1000 is an integrated ion chromatography system containing a pump, injection valve, column heater, and conductivity detector. Other system components, including a guard column, separator column, and suppressor vary, depending on the analyses to be performed.

The ICS-1000 can optionally be configured with a column heater for temperature control of the column.

ICS-1000 operation is controlled remotely by a personal computer running Windows® 2000 or Windows XP and Chromeleon software (version 6.5 SP2 or later). Chromeleon also provides data acquisition and data processing functions.

For communication between the ICS-1000 and Chromeleon, the ICS-1000 is connected to a USB (Universal Serial Bus) port on the computer or a USB hub. For installation instructions, see [Section B.5](#) and also refer to *Installing the Chromeleon Chromatography Management System with a Dionex Ion Chromatograph (IC)* (Document No. 031883).

1.3 About This Manual

The electronic version (i.e., PDF file) of the ICS-1000 operator's manual contains numerous hypertext links that can take you to other locations within the file.

These links include:

- Table of contents entries
- Index entries
- Cross-references (underlined in blue) to sections, figures, tables, etc.

If you are not familiar with how to navigate PDF files, refer to the Help system for Adobe® Acrobat® or Adobe Reader® for assistance

Chapter 1 Introduction	Introduces ion analysis and the ICS-1000; explains the conventions used in this manual, including safety-related information.
Chapter 2 Features Overview	Provides an overview of ICS-1000 operating features and system components; introduces the Chromeleon user interface.
Chapter 3 Operation and Maintenance	Provides operating instructions and describes routine preventive maintenance procedures.
Chapter 4 Troubleshooting	Lists problems and presents step-by-step procedures for how to isolate and eliminate the cause of each problem.
Chapter 5 Service	Provides step-by-step instructions for routine service and parts replacement procedures that the user can perform.
Appendix A Specifications	Lists the ICS-1000 specifications and installation site requirements.
Appendix B Installation	Describes how to install the ICS-1000.
Appendix C TTL and Relay Control	Describes the ICS-1000 TTL and relay control features.

Appendix D Reordering Information

Lists spare parts for the ICS-1000.

Appendix E FAQ

Provides answers to frequently asked questions about ICS-1000 operation.

Appendix F Glossary

Defines terms commonly used in ion analysis.

1.3.1 Safety Messages and Notes

The ICS-1000 is designed for IC (ion chromatography) applications and should not be used for any other purpose. If there is a question regarding appropriate usage, contact Dionex at 1-800-346-6390 before proceeding. Outside the United States, call the nearest Dionex office.

This manual contains warnings and precautionary statements that, when properly followed, can prevent personal injury and/or damage to the instrument. Safety messages appear in bold type and are accompanied by icons, as shown below.



Indicates an imminently hazardous situation which, if not avoided, will result in death or serious injury.



Indicates a potentially hazardous situation which, if not avoided, could result in death or serious injury.



Indicates a potentially hazardous situation which, if not avoided, may result in minor or moderate injury. Also used to identify a situation or practice that may seriously damage the instrument, but will not cause injury.



Indicates that the function or process of the instrument may be impaired. Operation does not constitute a hazard.

Messages d'avertissement en français



Signale une situation de danger immédiat qui, si elle n'est pas évitée, entraînera des blessures graves à mortelles.



Signale une situation de danger potentiel qui, si elle n'est pas évitée, pourrait entraîner des blessures graves à mortelles.



Signale une situation de danger potentiel qui, si elle n'est pas évitée, pourrait entraîner des blessures mineures à modérées. Également utilisé pour signaler une situation ou une pratique qui pourrait gravement endommager l'instrument mais qui n'entraînera pas de blessures.

Warnhinweise in Deutsch



Bedeutet unmittelbare Gefahr. Mißachtung kann zum Tod oder schwerwiegenden Verletzungen führen.



Bedeutet eine mögliche Gefährdung. Mißachtung kann zum Tod oder schwerwiegenden Verletzungen führen.



Bedeutet eine mögliche Gefährdung. Mißachtung kann zu kleineren oder mittelschweren Verletzungen führen. Wird auch verwendet, wenn eine Situation zu schweren Schäden am Gerät führen kann, jedoch keine Verletzungsgefahr besteht.

Notes

Informational messages also appear throughout this manual. These are labeled NOTE and are in bold type:

NOTE NOTES call attention to certain information. They alert you to an unexpected result of an action, suggest how to optimize instrument performance, etc.

1.3.2 Safety Labels

The TUV GS and c TUVus Mark safety labels and the CE Mark label on the ICS-1000 indicate that the ICS-1000 is in compliance with the following standards: EN 61010-1:2001 (safety), CAN/CSA-C22.2 No. 1010.1-92 +A2:97 (safety), UL 3101-1/10.93 (safety), and EN 61326:1997, including A1:1998 and A2:2001 (EMC susceptibility and immunity).

The symbols below appear on the ICS-1000 or on labels affixed to the ICS-1000.



Alternating current



Protective conductor terminal (earth ground)



Power supply is on



Power supply is off

This chapter describes key ICS-1000 features and introduces the Chromeleon user interface.

2.1 Operating Features

2.1.1 Front Panel

[Figure 2-1](#) illustrates the front panel of the ICS-1000.

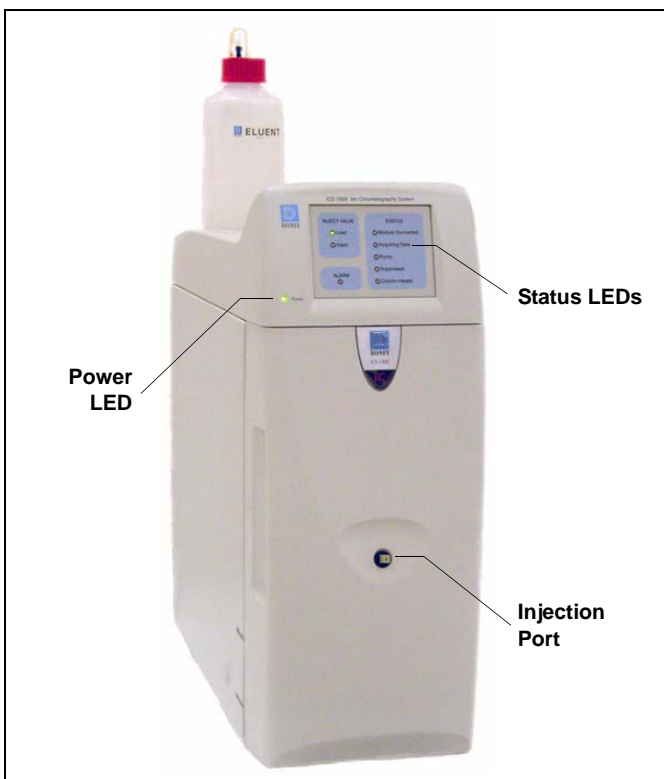

Figure 2-1. ICS-1000 Front Panel

Injection Port

The sample to be analyzed can be injected manually into the injection port, using a syringe. For automated sample injection, the ICS-1000 must be connected to an autosampler. For more information about sample injection, see [Section 3.10](#).

LEDs

The status LEDs (see [Figure 2-2](#)) indicate the status of various system functions. See [Table 2-1](#) for a description of each LEDs function. The power LED indicates whether the ICS-1000 power is on.

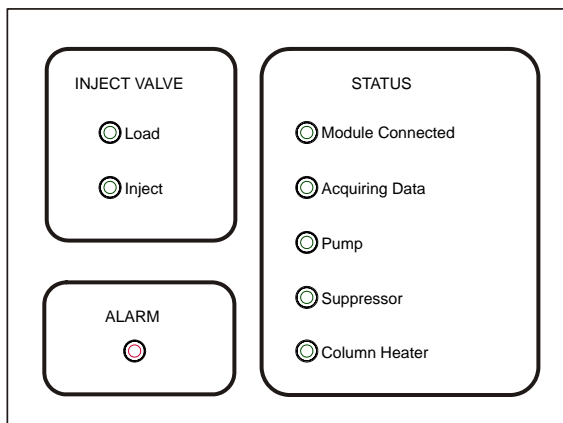

Figure 2-2. Status LEDs

LED Label	If On (Green)	If Flashing
Load	Injection valve is in Load position.	Valve error.
Inject	Injection valve is in Inject position.	Valve error.
Alarm	No “on” (green) state.	Error detected. Check the Chromeleon Audit Trail for the cause.
Module Connected	ICS-1000 is connected to a Chromeleon timebase.	Does not flash.
Acquiring Data	Sequence or manual data acquisition is in progress.	Sequence has stopped due to an error.
Pump	Pump is on.	High or low pressure limit is exceeded. The pump is turned off
Suppressor	Suppressor is on and current is being applied to it.	Continuity check failed or suppressor is over the voltage, current, or power limit. The suppressor is turned off
Column Heater	Column heater is at set temperature.	Column heater is transitioning to a new temperature.

Table 2-1. ICS-1000 Status LED States

2.1.2 Top Cover

[Figure 2-3](#) illustrates the top cover of the ICS-1000.

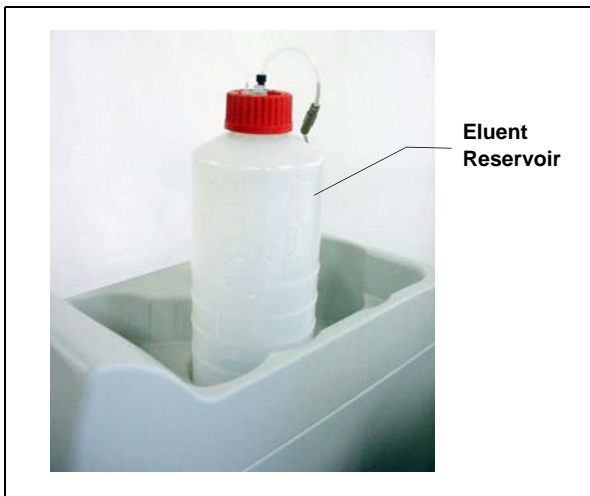

Reservoir Storage

The ICS-1000 top cover has room for up to three 2-L plastic reservoirs (P/N 044129).

Tubing Chase

The tubing chase under the top cover routes tubing to the front of the ICS-1000.

Figure 2-3. ICS-1000 (Top View)

2.1.3 Component Panel

[Figure 2-4](#) shows the user-accessible components installed on the component panel behind the ICS-1000 front door.

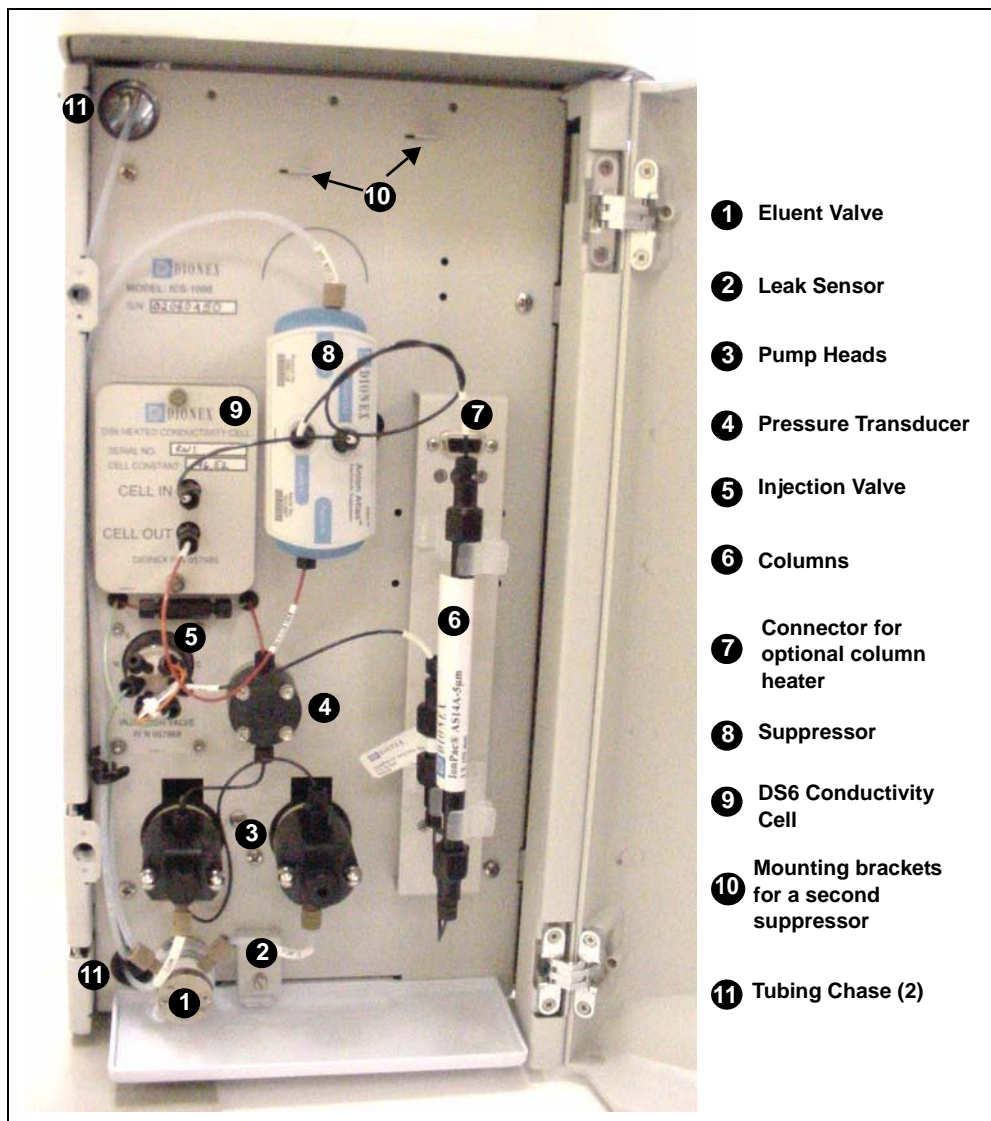

Figure 2-4. ICS-1000 Component Panel

Eluent Valve

The eluent valve controls the flow from the eluent reservoir. The eluent valve opens automatically when the pump is started and closes when the pump is turned off.

Leak Sensor

The leak sensor is installed in the drip tray at the bottom of the component panel. If liquid accumulates in the tray, an error message is logged in the Chromeleon Audit Trail and the Alarm LED flashes.

Pump Heads

The ICS-1000 includes a dual-piston serial pump. The flow rate can be set to 0.00 mL/min or to between 0.05 and 5.00 mL/min. However, for optimum performance, set the flow rate to between 0.40 and 2.00 mL/min. Setting the flow rate to 0.00 mL/min turns off the pump. See [Section 2.4.3](#) for details about the pump.

Pressure Transducer

The pressure transducer measures the system backpressure.

Injection Valve

The injection valve is a six-port, electrically-activated valve. A 25- μ L sample loop (P/N 042857) is installed on the valve at the factory. See [Section 2.4.4](#) for details about valve operation.

Separator and Guard Columns

Both the separator and guard columns are packed with resin and perform the separation of the sample ions. The main function of the guard column is to trap contaminants and remove particulates that might damage the separator column.

Column Heater (Optional—Not Pictured)

The column heater controls the temperature of the separator and guard columns. The temperature can be set to between 30 and 60 °C, however it must be set at least 5 °C above the ambient temperature. See [Section 2.4.5](#) for details about the column heater.

Suppressor

The suppressor reduces the eluent conductivity and enhances the conductivity of the sample ions, thereby increasing detection sensitivity. Either an AES® Atlas Electrolytic Suppressor, SRS® Self-Regenerating Suppressor, or MMS™ MicroMembrane™ Suppressor can be used with the ICS-1000. See [Section 2.4.6](#) for details about the suppressor.

DS6 Heated Conductivity Cell

The flow-through conductivity cell measures the electrical conductance of analyte ions as they pass through the cell. A heat exchanger inside the cell regulates the temperature, which can be set to between 30 and 55 °C. For optimum performance, set the temperature to at least 7 °C above the ambient temperature. See [Section 2.4.7](#) for details about the cell.

Tubing Chases

The upper tubing chase routes tubing from the top cover to the component panel. The lower tubing chase routes tubing from the component panel, through the ICS-1000 interior, to the rear panel.

2.1.4 Rear Panel

[Figure 2-5](#) illustrates the ICS-1000 rear panel.

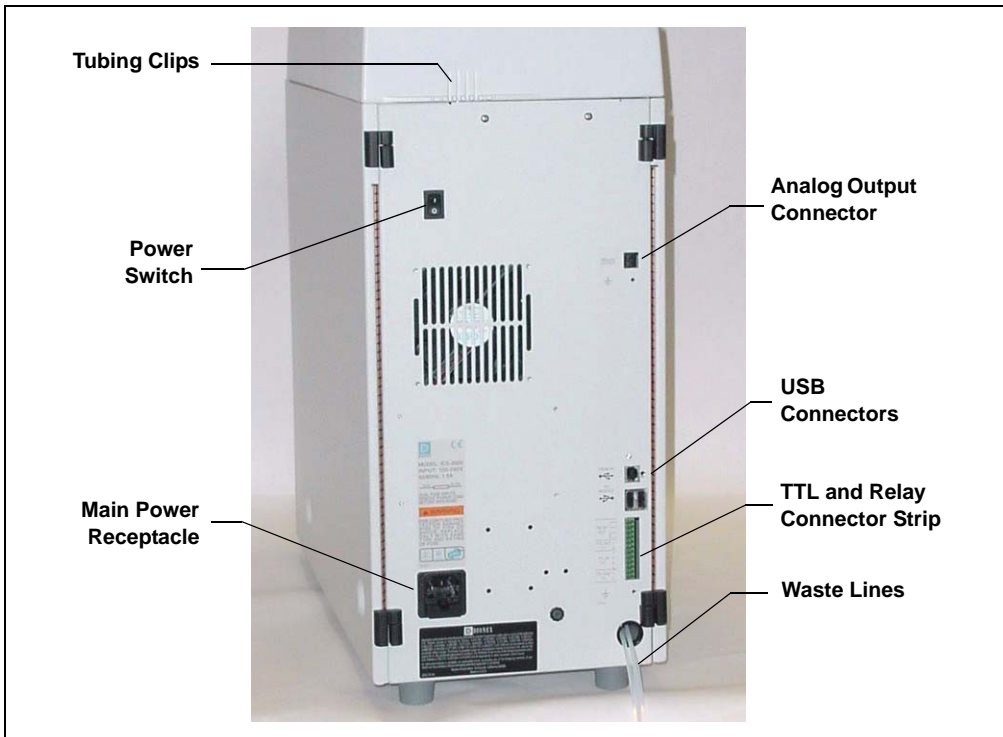

Figure 2-5. ICS-1000 Rear Panel

Analog Output Connector

The analog output connector outputs conductivity data (scaled to 1 volt) to an integrator or recording device. See [Section B.19](#) for connection and setup information.

USB Connectors

A USB receptacle is provided to allow connection to the Chromeleon computer. Two USB ports are provided for connecting to other USB devices. See [Section B.5](#) for connection instructions.

TTL and Relay Connector

The TTL and Relay connector strip provides two TTL outputs, two relay outputs, and four TTL inputs. The outputs can be used to control functions in other TTL- or relay-controllable devices. The inputs can be used to switch the injection valve position, turn on the pump, perform an autozero command, and send an event mark to the analog output. See [Section C.1](#) for connection instructions.

Tubing Clips

The tubing clips hold tubing routed from the top cover in place.

Power Switch

The power switch provides on/off control of power to the ICS-1000.

Main Power Receptacle

The power supply cord plugs into the AC power receptacle.



The power supply cord is used as the main disconnect device. Make sure the socket-outlet is located near the ICS-1000 and is easily accessible.



Le cordon d'alimentation principal est utilisé comme dispositif principal de débranchement. Veillez à ce que la prise de base soit située/installée près du module et facilement accessible.



Das Netzkabel ist das wichtigste Mittel zur Stromunterbrechung. Stellen Sie sicher, daß sich die Steckdose nahe am Gerät befindet und leicht zugänglich ist.

2.2 Flow Schematic

[Figure 2-6](#) illustrates the liquid flow path through an ICS-1000 when using suppression in autorecycle mode.

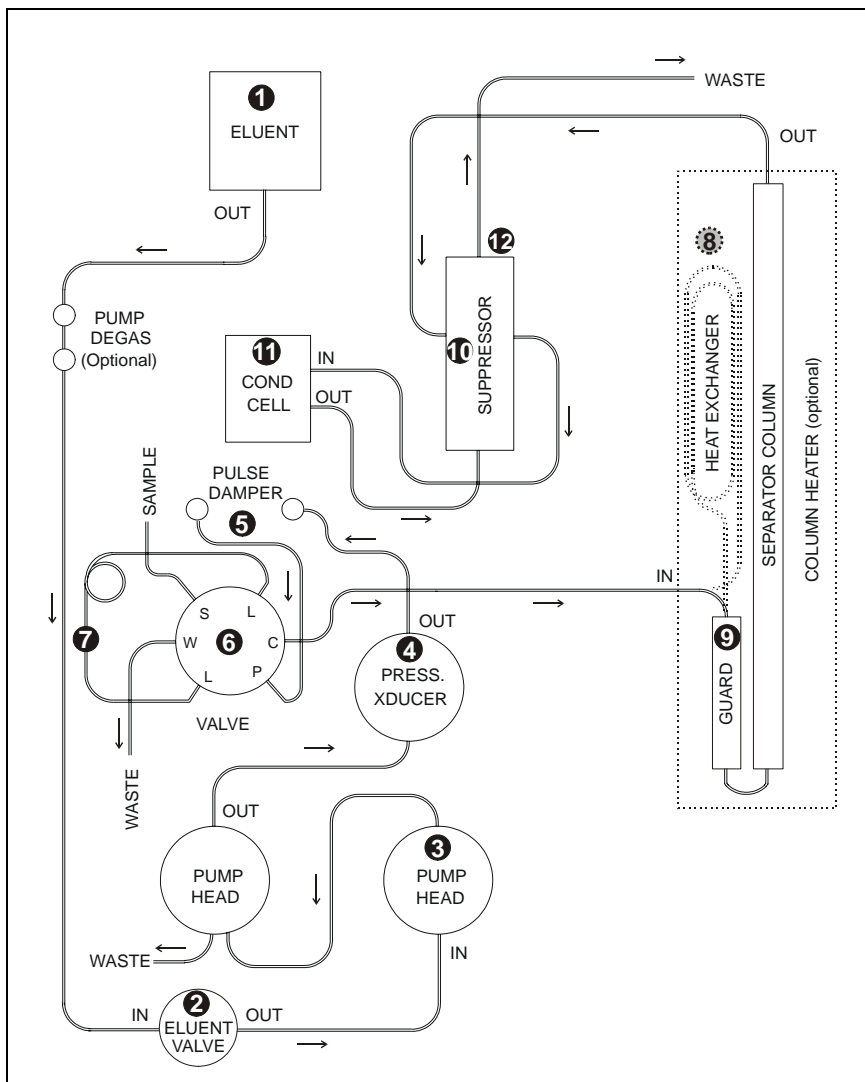

Figure 2-6. ICS-1000 Flow Schematic

ICS-1000 Ion Chromatography System

- Eluent from the eluent reservoir **1** flows first through the pump degas assembly (if it is installed) and then through the eluent valve **2** to the pump **3**. The eluent is then pushed through the pressure transducer **4**, which measures the system pressure.
- From there, the eluent is pushed through a pulse damper **5**, which smooths minor pressure variations from the pump to minimize baseline noise. The eluent then flows into the injection valve. **6**
- After sample is loaded into the sample loop **7** and the injection valve is toggled to the Inject position, eluent passes through the sample loop.
- If the optional column heater is installed, the eluent/sample mixture is pumped through the heat exchanger **8**, which heats the mixture to the column heater temperature.
- The mixture then goes to the guard and separator columns **9** and through the suppressor. **10**
- From the suppressor, the mixture flows through the cell **11**, where the analytes are detected. A digital signal is sent to Chromeleon software. Analog output can be collected simultaneously.
- Finally, the mixture flows out of the cell and is recycled back into the suppressor, where it is used as the water source for the regenerant chamber. Flow is then routed to waste. **12**

2.3 The Chromeleon Interface

NOTE This section provides a brief overview of the Chromeleon interface. For details, refer to the Chromeleon Help or user's manual.

Chromeleon software is used for remote control of ICS-1000 operation. Two modes of software control are available: direct control and automated control.

- With direct control, you select operating parameters and commands from the Chromeleon menu bar, toolbars, and Control panels. Direct control commands are executed as soon as they are entered. [Section 2.3.2](#) describes the commands available from the ICS-1000 Control panels.
- With automated control, you create a list of samples (a sequence) to be processed automatically. The sequence includes programs with commands and parameters for controlling the ICS-1000, acquiring sample data, and producing reports. [Section 3.11.2](#) describes automatic sample processing.

2.3.1 The Chromeleon Main Window and Browser

When you start Chromeleon, the main window and the Chromeleon Browser appear (see [Figure 2-7](#)).

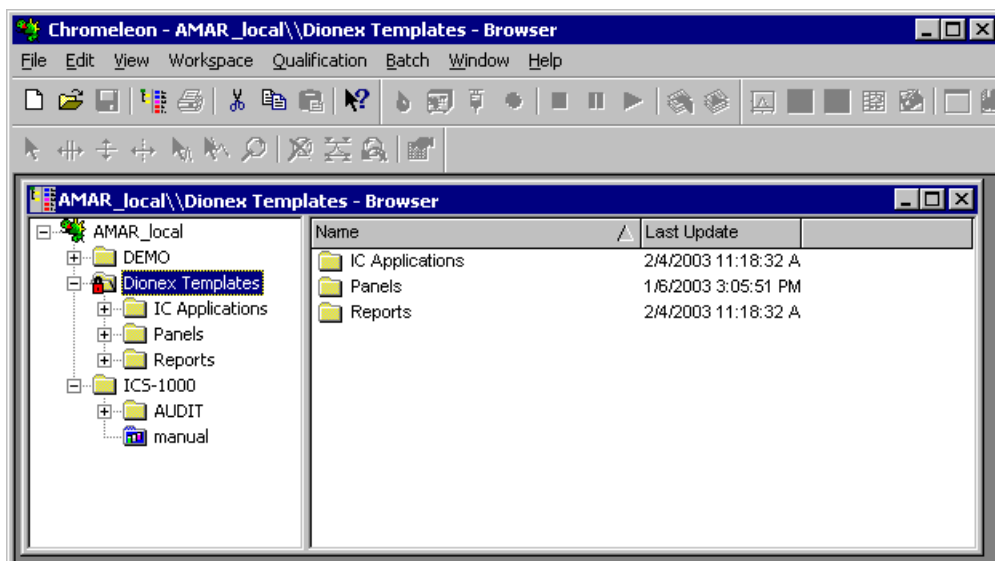

Figure 2-7. Chromeleon Main Window and Browser

NOTE The Chromeleon Browser looks and functions like Windows Explorer, but do not confuse the two. If you copy files from the Chromeleon Browser into Explorer, the files will be corrupted.

The Browser displays the directories in which chromatographic data is located, and allows you to open, move, and delete data.

- The left pane of the Browser shows the directory tree structure. By clicking the '+' signs next to the folders and expanding the directory tree, you can access sequences, System Control panels, Wellness Panels, and reports.
- The right pane displays information about the item selected in the left pane.

2.3.2 The ICS-1000 Control Panels

Chromeleon provides two types of Control panels for the ICS-1000.

- System Control panels are used for controlling and monitoring ICS-1000 operation. System Control panels are described below.
- The Wellness Panel is used for performing calibration and diagnostic functions. The Wellness Panel is described in [Section 5.1](#).

System Control Panels

System Control panels for the ICS-1000 are located in the **Dionex Templates/Panels/Dionex_IC\ICS-1000** folder. Chromeleon provides panels for each ICS-1000 system configuration. There are two styles of panels:

- Traditional system panels (see [Figure 2-8](#)) provide controls on a single window with minimal graphics.
- System panels (see [Figure 2-9](#)) provide a more graphical interface than the traditional style. On these panels, clicking a control often brings up another window in which you enter a value.

When you open a System Control panel, select a panel that matches your system configuration and choose the style that you prefer.

ICS-1000 Ion Chromatography System

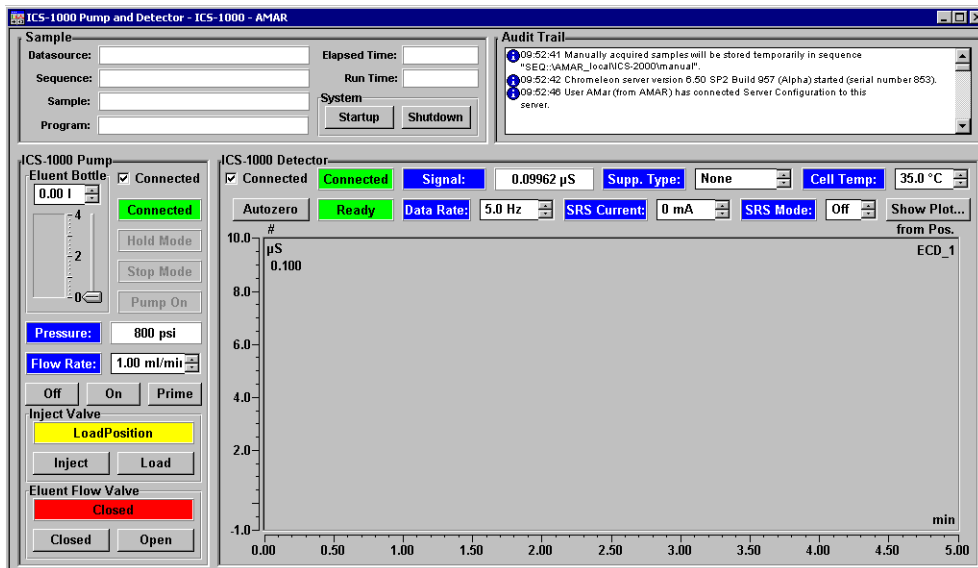

Figure 2-8. ICS-1000 System Control Panel (Traditional)

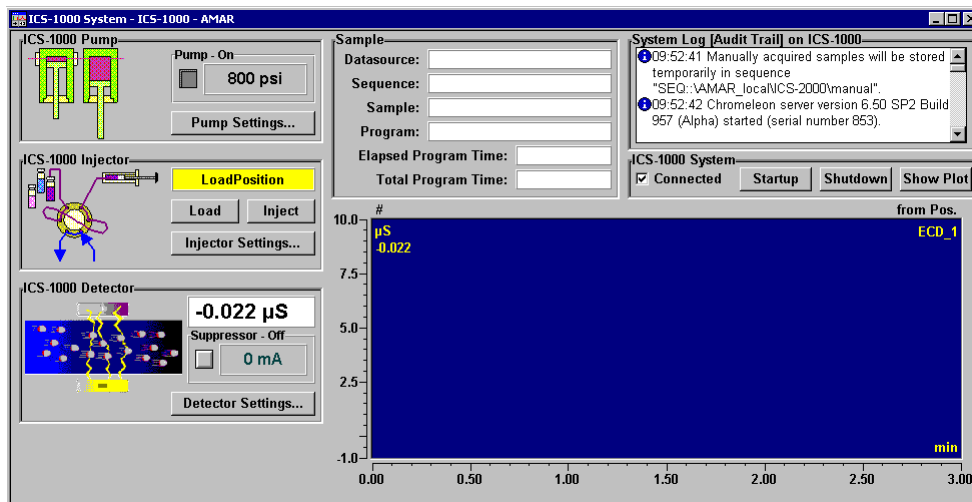



Figure 2-9. ICS-1000 System Control Panel (Graphical)

System Controls Overview

This section provides brief descriptions of the various controls available on the ICS-1000 System Control panels.

NOTE The examples are from the traditional style of panel.

Sample



The screenshot shows a control panel with a green border. On the left, under the heading "Sample", there are four text input fields labeled "Datasource:", "Sequence:", "Sample:", and "Program:". On the right, there are two text input fields labeled "Elapsed Time:" and "Run Time:". Below these fields is a section titled "System" containing two buttons: "Startup" and "Shutdown".

Datasource

Displays the database in which the chromatographic data for the sample is saved.

Sequence

Displays the sequence in which this sample is included.

Sample

Displays the name of the sample that is running.

Program

Displays the name of the program that is running.

Elapsed Time

Displays the time that has elapsed since the sample analysis began.

Run Time

Displays the total run time.

System

Startup

Starts the pump and suppressor. The flow rate and suppressor current settings that were in effect at system shutdown (see below) are restored.

Shutdown

Stops the pump and suppressor. The flow rate and suppressor current settings currently in effect are remembered and will be restored at system startup (see above).

Audit Trail

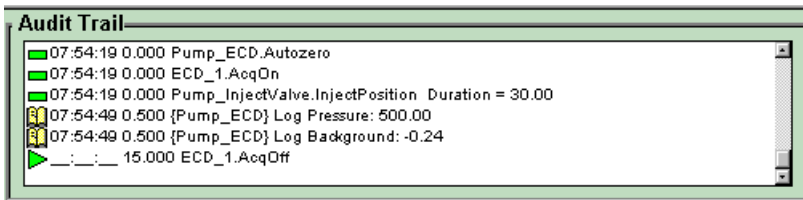

The Audit Trail displays an account of every event that occurs during ICS-1000 operation. This includes errors, status messages, operational events, etc.

Pump

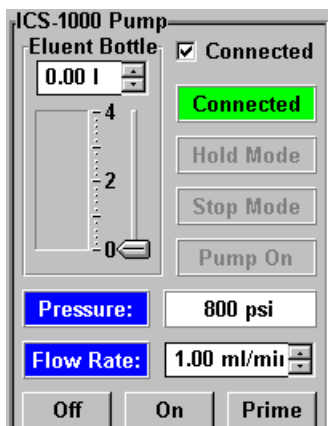

Eluent Bottle

The entry field and gauge indicate the level of liquid (in liters) in the eluent bottle. This is a user-controlled feature. The level must be entered by the user when the reservoir is filled. See [Section 3.4.4](#) for details.

Connected

Connects the ICS-1000 to the Chromeleon Control panel, enabling communication between the PC and the module. Clearing the check box disconnects the ICS-1000 from the PC.

Hold Mode

Indicates when an automatic (batch) run is on hold; pump flow is not stopped.

Stop Mode

Indicates when an automatic (batch) run is stopped; pump flow is stopped also.

Flow Rate

Sets the pump flow rate in mL/min.

Pressure

The sliders select the upper and lower pressure limits. The **Pressure** field displays the current pressure.

On, Off, Prime

Turn the pump on and off or start the pump priming function.

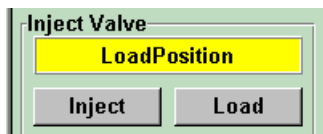
**Inject Valve**

Displays the current position of the inject valve. The **Inject** and **Load** buttons select the position.

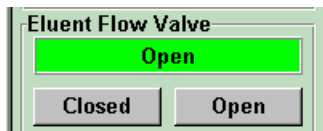
**Eluent Flow Valve**

Displays the current position of the eluent flow valve. The **Closed** and **Open** buttons select the position.

Column Heater (Optional)**Set Temp**

Sets the temperature of the column heater.

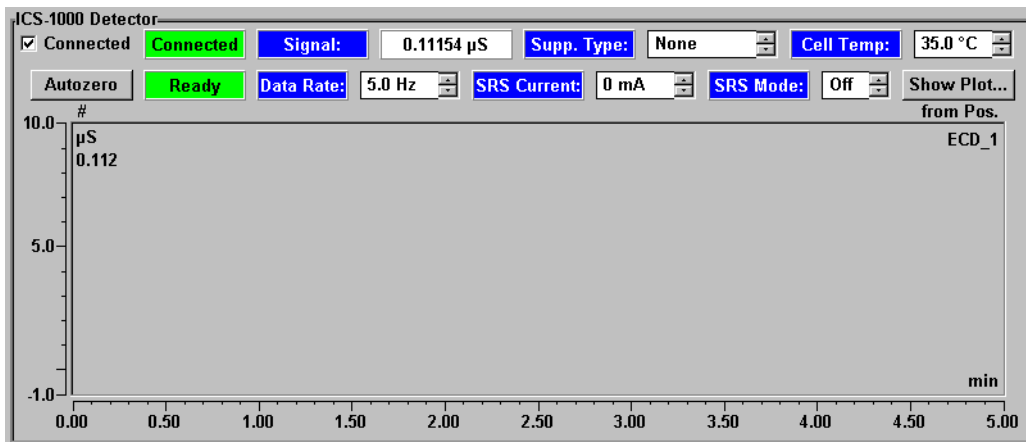
Detector**Connected**

Connects the ICS-1000 to the Chromeleon Control panel, enabling communication between the PC and the module. Clearing the **Connected** check box disconnects the ICS-1000 from the PC.

Autozero

Sets the conductivity to zero.

Ready

Indicates whether the detector is ready to begin data acquisition.

Signal

Displays the offset conductivity.

Data Rate

Sets the rate at which data points are recorded.

Supp. Type

Selects the type of suppressor installed.

SRS Current

Sets the current supplied to the suppressor.

Cell Temp

Sets the temperature of the cell.

SRS Mode

Turns the suppressor on or off.

Show Plot

Displays the ICS-1000 detector signal plot in a separate window.

2.4 System Component Details

This section provides details about ICS-1000 system components, including the vacuum degas assembly (optional), eluent valve, pump, injection valve, column heater (optional), suppressor, and conductivity cell.

2.4.1 Vacuum Degas Assembly (Optional)

The vacuum degas assembly provides online eluent degassing at the time and duration specified by the user. The assembly, which must be installed in the ICS-1000 at the factory, consists of:

- A single-channel degas chamber (with degas membranes) with internal capacity of 17 mL
- A dual-stage diaphragm vacuum pump
- A solenoid valve
- An on-board vacuum sensor
- The electronics required to operate the vacuum pump
- Tubing, fittings, and other accessories

By default, the ICS-1000 monitors the degas pressure reading and turns the degas pump on and off as needed. A different degas operating mode can be selected from Chromeleon. To select degas operating options from Chromeleon, open the Server Configuration program, select the ICS-1000

device icon under the timebase, and select **Edit>Properties**. Select the **Options** tab (see [Figure 2-10](#)).

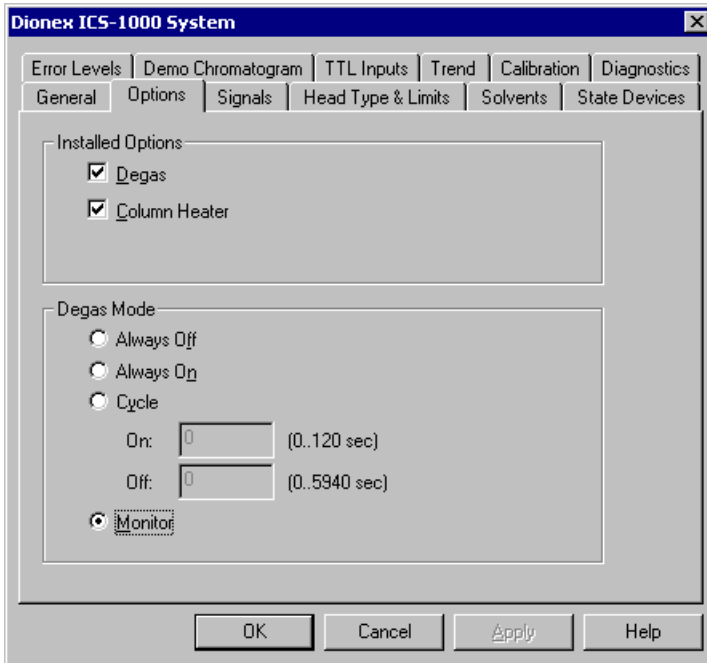

Figure 2-10. Server Configuration Properties: Degas Mode Options

Degas Mode Options

- **Always Off:** The degas pump is always off.
- **Always On:** The degas pump is always on. This setting is for test purposes by a Dionex Service Representative. Do not use this setting for routine operation.
- **Cycle:** The degas pump cycles on and off according to the times specified in the **Cycle On** and **Off** fields. **Cycle On** specifies for how long the degas pump runs during a cycle. **Cycle Off** specifies the time between cycles.
- **Monitor:** (default mode) The ICS-1000 monitors the degas pressure reading and turns the degas pump on and off as required.

2.4.2 Eluent Valve

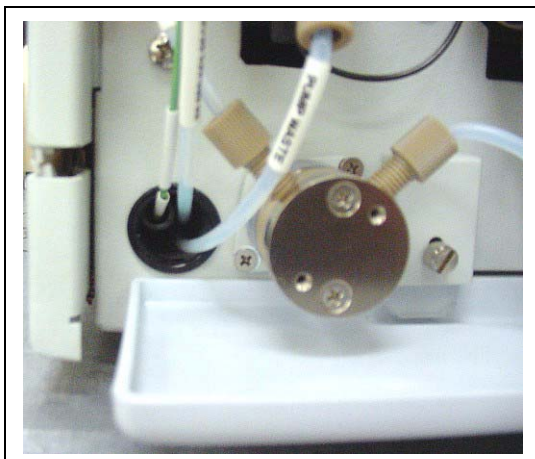

Figure 2-11. Eluent Valve

The eluent valve controls the flow from the eluent reservoir. The valve opens automatically when the pump is started and closes when the pump is turned off. The valve can also be opened and closed manually either from the Chromeleon Control panel (see [Section 2.3.2](#)). This lets you perform service procedures on pump components without eluent leaks occurring.

2.4.3 Pump

The ICS-1000 pump is a microprocessor-based isocratic eluent delivery system. Its variable speed, dual-piston series design ensures pulse-free pumping for the most demanding applications.

Primary Pump Head

The primary pump head pumps eluent into the secondary head (see [Figure 2-12](#)). The check valves, which prevent reverse flow through the pump, are located on the bottom (inlet) and top (outlet) of the primary pump head. The priming valve is on the front of the pump head.

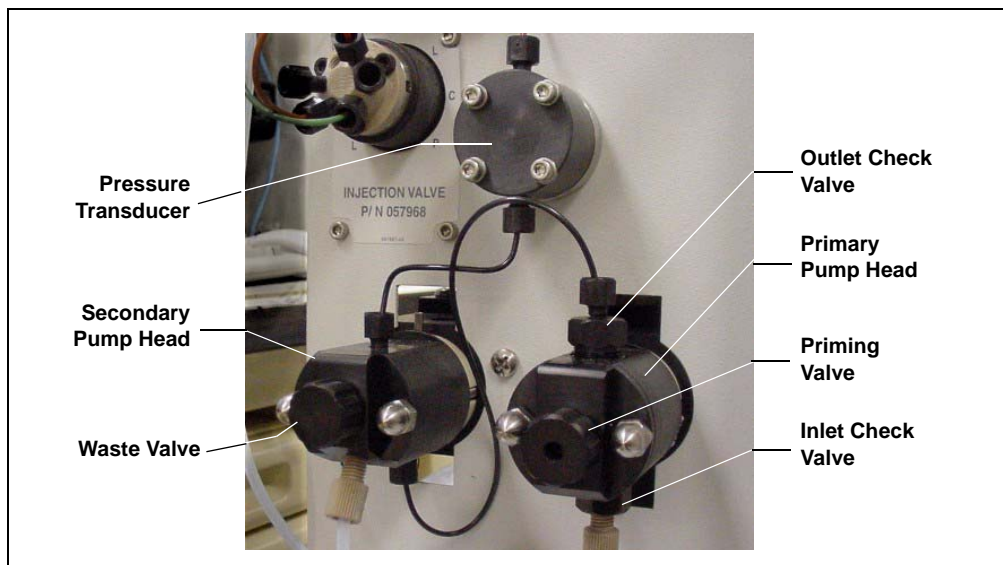

Figure 2-12. ICS-1000 Pump Components

To open the priming valve, turn the knob one-quarter to one-half turn counterclockwise. When the priming valve is open, liquid can flow into and out of the primary pump head via the port in the front of the valve.

NOTE The priming valve must be open when the pump is being primed with a syringe or with isopropyl alcohol. For detailed priming instructions, see [Section B.14](#).

Secondary Pump Head

The secondary pump head delivers eluent to the remainder of the chromatography system (the injection valve, column, and detector). The waste valve is located on the front of the secondary pump head (see [Figure 2-12](#)).

To open the waste valve, turn the knob one-quarter to one-half turn counterclockwise. When the waste valve is in the open position, all output is directed to waste.

NOTE The waste valve must be open when the pump is being primed using the **Prime** button. For detailed priming instructions, see [Section B.14](#).

Pressure Transducer

Flow exiting the secondary pump head is directed to the pressure transducer (see [Figure 2-12](#)), which measures the system pressure.

Pressure readings indicate that the pumping system is delivering smooth, accurate flow. Pressure readings can be monitored from the Chromeleon Control panel.

The system pressure should remain consistent (no more than a 3% difference from one pressure reading to the next). High and low pressure limits can be used to stop the pump flow if a limit is exceeded. The pressure limits can be set from Chromeleon (in the Server Configuration or in the control program). See [Section 4.1](#) for troubleshooting information if a pressure limit is exceeded.

Pulse Damper

Flow output from the pressure transducer continues to the pulse damper, which smooths minor pressure variations. From there, flow is directed to the injection valve and then to the remainder of the chromatography system.

Piston Seal Wash

The pump includes a piston seal wash assembly that can be set up to continuously rinse the back of the piston seals to remove salt crystals and prolong the life of the seals. To use this feature, an external water source must be connected. See [Section B.21](#) for connection instructions.

For continued protection of the pump, replace the piston rinse seals (see [Section 5.6](#)) and O-rings in the seal wash assembly every 6 months, or whenever you replace the main piston seals for the ICS-1000 pump.

2.4.4 Injection Valve

The injection valve (P/N 057968) is a six-port, electrically-activated valve. A 25- μ L sample loop (P/N 042857) is installed on the valve at the factory.

The valve has two operating positions: Load and Inject (see [Figure 2-13](#)).

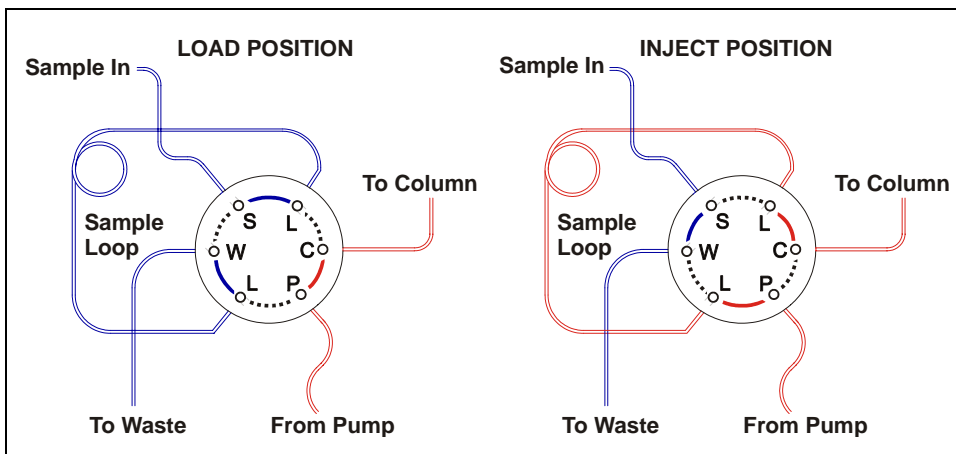

Figure 2-13. Injection Valve Flow Schematics

Eluent flows through either the Load or Inject path, depending on the valve position.

- In the Load position, sample is loaded into the sample loop, where it is held until injection. Eluent flows from the pump, through the valve, and to the column, bypassing the sample loop. Sample flows from the syringe or automated sampler line (if installed), through the valve, and into the sample loop. Excess sample flows out to waste.
- In the Inject position, sample is swept to the column for analysis. Eluent flows from the pump, through the sample loop, and on to the column, carrying the contents of the sample loop with it. [Section 3.10](#) describes how to inject samples.

[Figure 2-14](#) shows the injection valve connections. The injection valve is plumbed at the factory with all tubing and fittings for connection to the pump, injection port, column, and waste. A 25- μ L PEEK sample loop (P/N 042857) is installed between ports L (1) and L (4). Dionex offers

sample loops in various sizes. If necessary, the pre-installed 25- μ L loop can be replaced with a loop that has a different sample injection volume.

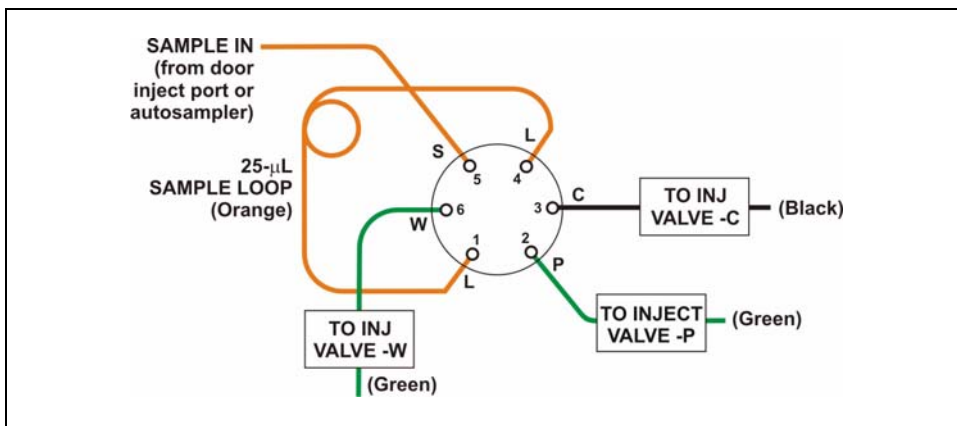

Figure 2-14. Injection Valve Plumbing

2.4.5 Column Heater (Optional)



The column heater provides temperature control for the separator and guard column.

The heater temperature can be set to between 30 and 60 °C. However, the set temperature must be at least 5 °C above the ambient temperature. A thermistor mounted in the heater block monitors the temperature. Setting the temperature to 0 °C turns off the column heater.

If the temperature exceeds 65 °C, the column heater is shut off and the error message “Column heater exceeds safe temperature.” is displayed in the Chromeleon Audit Trail. See [Section 4.1](#) for troubleshooting information.

The column heater can either be installed at the factory or ordered separately (P/N 058060).

Figure 2-15. Column Heater

2.4.6 Suppressor

The suppressor reduces the eluent conductivity and enhances the conductivity of the sample ions, thereby increasing detection sensitivity. Either an Atlas Electrolytic Suppressor, Self-Regenerating Suppressor, or MicroMembrane Suppressor can be used with the ICS-1000.

For details about any of the suppressors or for information about selecting a suppressor for your application, refer to the suppressor manuals. The manuals are on the Dionex Reference Library CD-ROM (P/N 053891).

2.4.7 DS6 Heated Conductivity Cell

The ICS-1000 flow-through conductivity cell measures the electrical conductance of analyte ions as they pass through the cell. Two passivated 316 stainless steel electrodes are permanently sealed into the PEEK cell body. The cell design provides efficient sweep-out, low volume (1 μ L), and low dispersion. Temperature control and compensation help ensure good peak reproducibility and baseline stability.

Temperature Control

Temperature directly affects the conductivity of a solution. For example, laboratory heating and air conditioning systems can cause a regular slow cycling in the baseline. This, in turn, can affect the reproducibility of an analysis. The higher the conductivity, the more pronounced the effect.

In ion analysis, the effect of temperature variation is minimized by suppressing eluent conductivity. To further reduce the effect of temperature variation, a heater inside the cell regulates the temperature. The cell heater can be set to between 30 °C and 55 °C. The set temperature must be at least 7 °C above the ambient temperature. Setting the cell temperature to 0 °C turns off the cell heater.

Temperature Compensation

Built-in preset temperature compensation of 1.7% per °C helps minimize changes in the baseline or in peak heights when the operating temperature is different from the temperature at which the cell was calibrated.

DS6 Heated Conductivity Cell Components

The cell front cover provides **CELL IN** and **CELL OUT** fittings for connecting the cell to the suppressor (see [Figure 2-4](#)). The remaining cell components are mounted behind the component panel. To replace, the cell remove the screws on the cell front cover and pull the entire cell assembly out through the component panel. See [Section 5.9](#) for cell replacement instructions.

3 • Operation and Maintenance

This chapter describes routine operating and maintenance procedures for the ICS-1000 Ion Chromatography System.

The ICS-1000 is designed for IC (ion chromatography) applications and should not be used for any other purpose. Operation of the ICS-1000 in a manner not specified by Dionex may result in personal injury.

3.1 Operation Overview

[Figure 3-1](#) illustrates the basic steps for routine operation of the ICS-1000.

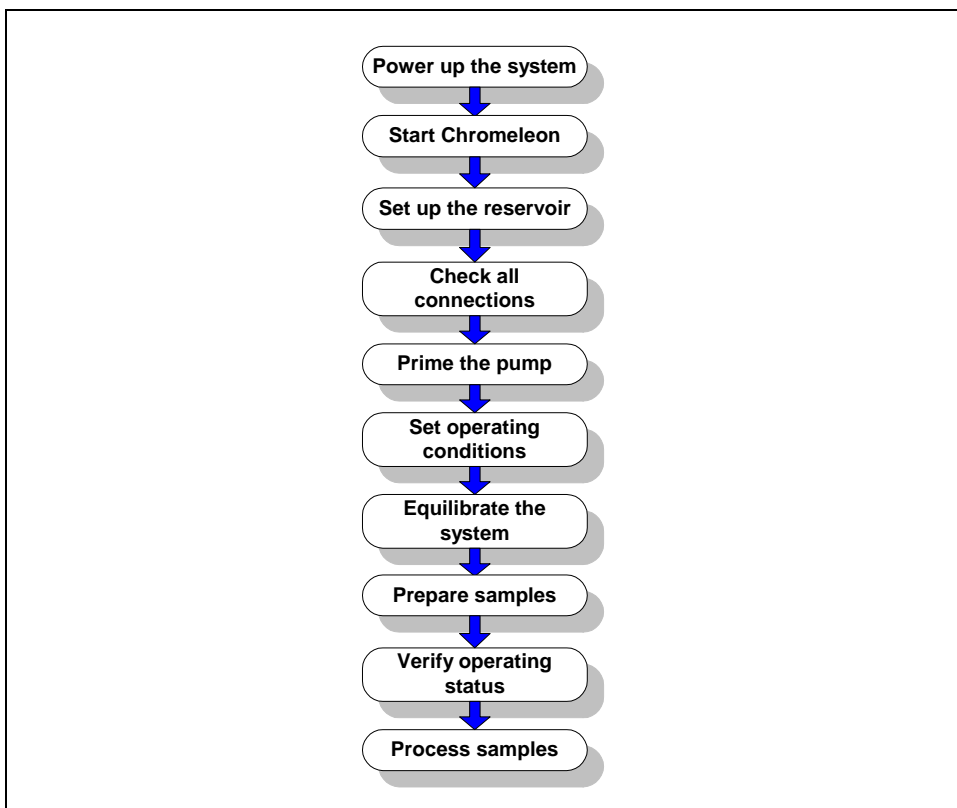

Figure 3-1. ICS-1000 Operation Flow Chart

Sample Processing Overview

Samples can be run manually (one at a time), or they can be grouped and run automatically in batches. [Figure 3-2](#) shows the typical steps for manual and batch sample processing.

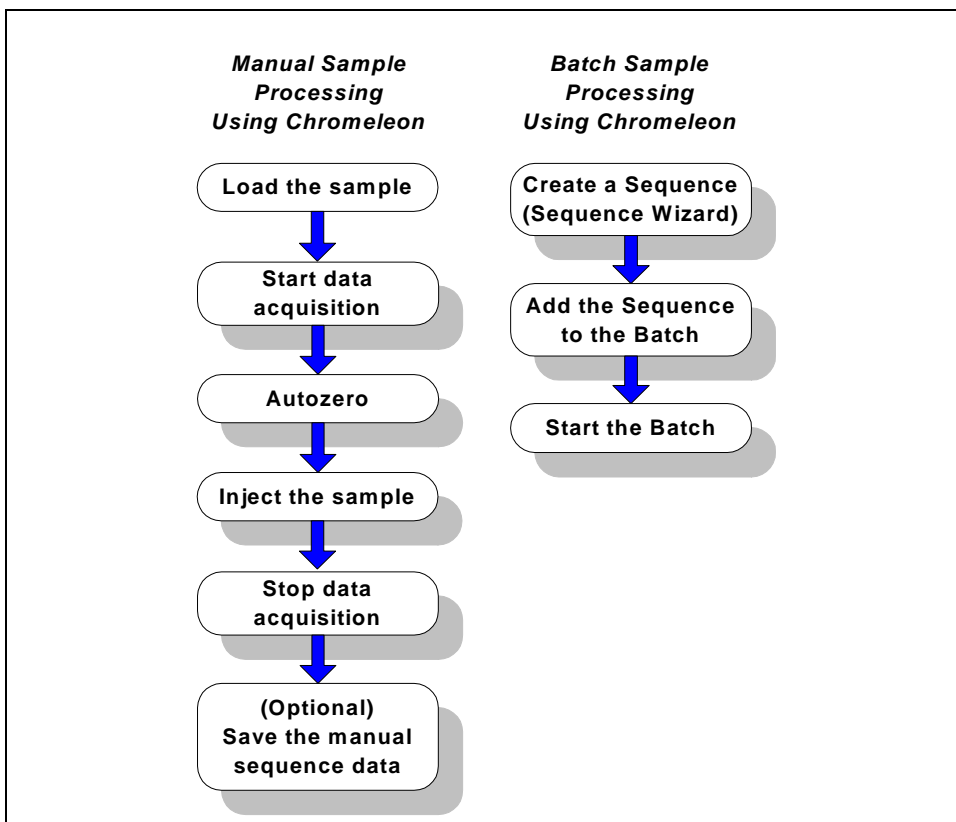

Figure 3-2. Sample Processing Overview

3.2 Power Up the System



Figure 3-3. ICS-1000 Rear Panel

Press the power switch on the ICS-1000 rear panel (see [Figure 3-3](#)) to turn on the system power. [Table 3-2](#) shows the ICS-1000 conditions at power up.

Also turn on the power to the computer and the autosampler (if used).



Feature	Power-Up Condition
Pump	Off
Injection valve	Load position
Cell	Reading current value
Suppressor	Off*
Cell heater	Set to the last value used. The default when the ICS-1000 is turned on for the first time is 35 °C.
Column oven temperature (Optional)	Set to the last value used. The default when the ICS-1000 is turned on for the first time is 30 °C.

Table 3-2. ICS-1000 Power-Up Conditions

* When you start the suppressor, the value used last is restored.

3.3 Start Chromeleon

NOTE If you are beginning operation of an ICS-1000 that has not been configured in a timebase, see [Section B.8](#) for Chromeleon setup instructions.

1. If the Chromeleon Server is not running (the icon on the taskbar is crossed out in red ) , start the Server by right-clicking the icon and selecting **Start Server**. When the server starts, the icon changes to gray  .
2. Start Chromeleon by selecting **Start>Programs>Chromeleon>Chromeleon**. The Chromeleon main window and the Browser will open. Your screen display should resemble [Figure 3-4](#). If the Browser does not open, select **File>Browser** to open it.

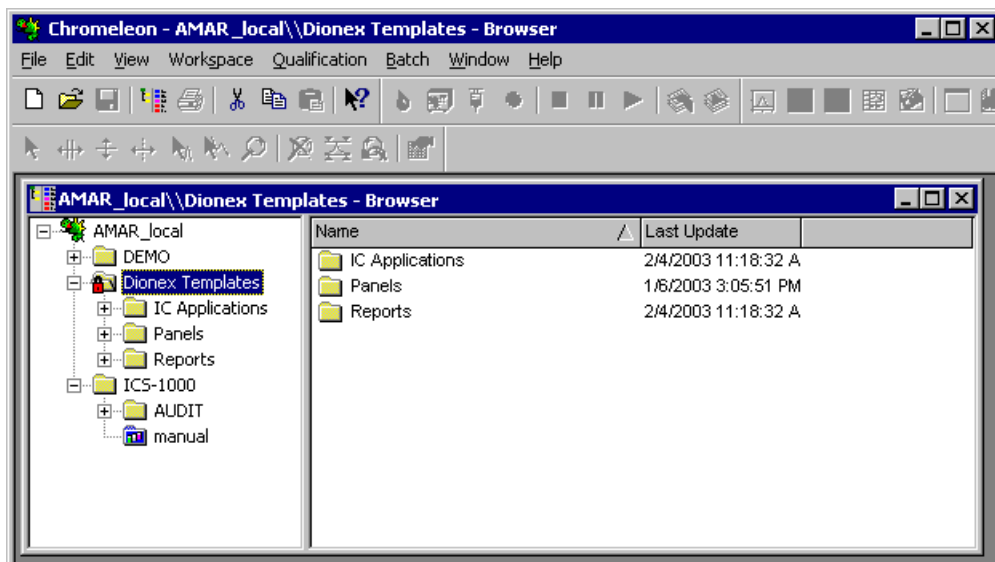

Figure 3-4. Chromeleon Main Window and Browser

- In the Browser, expand the **Dionex Templates\Panels\Dionex_IC\ICS-1000 System Panels** folder. Several ICS-1000 Control panels (.PAN files), corresponding to various system configurations, are provided. Two styles of panels are available:
 - Traditional panels provide controls on a single window with minimal graphics.
 - System panels provide a more graphical interface than the traditional style and include more controls.
- You can choose either style of panel, depending on your personal preference.
- Open a panel for your system configuration by double-clicking its name in the list. For example, if your system includes an ICS-1000 and an AS50 autosampler, double-click either **ICS-1000_Traditional_System_AS50.pan** or **ICS-1000_System_AS50.pan**.
 - The Control panel opens, unconnected (see [Figure 3-5](#)). To connect to the timebase, open the **Control** menu and click the name of the ICS-1000 timebase in the list at the bottom of the menu.

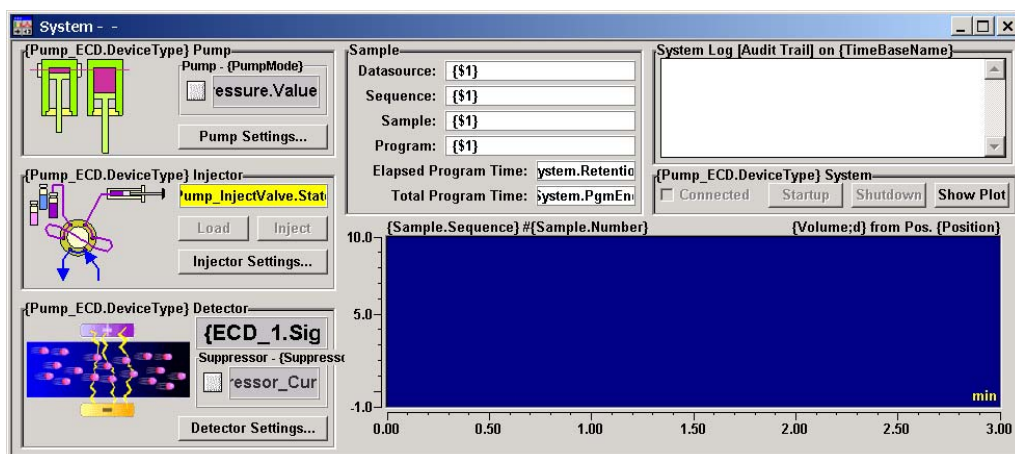

Figure 3-5. ICS-1000 System Control Panel (Unconnected)

Figure 3-6 shows a connected Control panel for an ICS-1000 system.

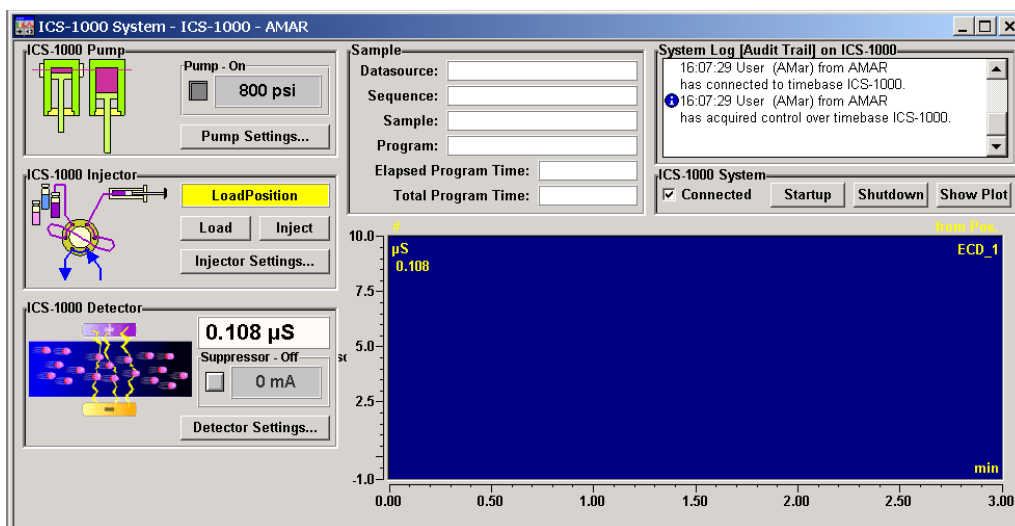

Figure 3-6. ICS-1000 System Control Panel (Connected)

3.4 Set Up the Eluent Reservoir

3.4.1 Prepare the Eluent

Prepare the eluent according to the instructions in the column manual. Column manuals are included on the Dionex Reference Library CD-ROM (P/N 053891).

3.4.2 Degas the Eluent

Eluent quality significantly affects the performance of the ICS-1000. To ensure optimal pump performance, observe the following precautions:

- Dionex strongly recommends vacuum degassing all eluents. This helps prevent bubbles, caused by outgassing, from forming in the pump heads and the detector flow cell.
- The optional vacuum degas assembly provides programmable, online degassing. The degas assembly must be installed in the ICS-1000 at the factory. If the ICS-1000 does not contain a degas assembly,

manually degas eluents daily (following the instructions below) and store it in pressurized reservoirs.

Manual Degassing of Eluent

1. Prepare the eluent required for the application and pour it into a vacuum flask
1. Pour the deionized water into a vacuum flask
2. Attach the flask to a vacuum pump or water aspirator.
3. Vacuum degas the eluent deionized water for 5 to 10 minutes by shaking or sonication.
4. Remove the flask from the vacuum. **Do not allow water to flow from the aspirator back into the flask.**
5. Pour the degassed eluent deionized water into a pressurizable reservoir. **Do not shake the eluent.**
6. Install an end-line filter on the eluent deionized water line (see [Section 3.4.3](#)).
7. Pressurize the reservoir (see [Section B.20](#)).

3.4.3 Filter the Eluent

Filtering removes small particulates in the eluent that may contaminate the pump check valves and cause erratic flow rates or loss of prime. An end-line filter (P/N 045987) is provided in the ICS-1000 Ship Kit (P/N 057905) for this purpose.

Install the end-line filter on the end of the eluent line, inside the reservoir. Verify that the end of the filter extends to the bottom of the reservoir and that the filter is submerged in eluent. This prevents air from being drawn through the lines.

3.4.4 Fill the Reservoir

Fill the reservoir with the prepared eluent.

3.4.5 Set the Eluent Level

After filling the reservoir, enter the volume of liquid in the reservoir on the Chromeleon Control panel (see [Figure 3-6](#)). The ICS-1000 determines the eluent usage by monitoring the flow rate and the length of time the pump is on, and updates the **Eluent Level** field as the eluent is used up. A warning first appears if the level falls below 200 mL. Warnings are repeated at 100 mL and 0 mL.

IMPORTANT

In order for the eluent level displayed on the Control panel to be accurate, the level must be entered by the user when the reservoir is filled. The ICS-1000 does not automatically detect when the reservoir is filled, nor when it is empty.

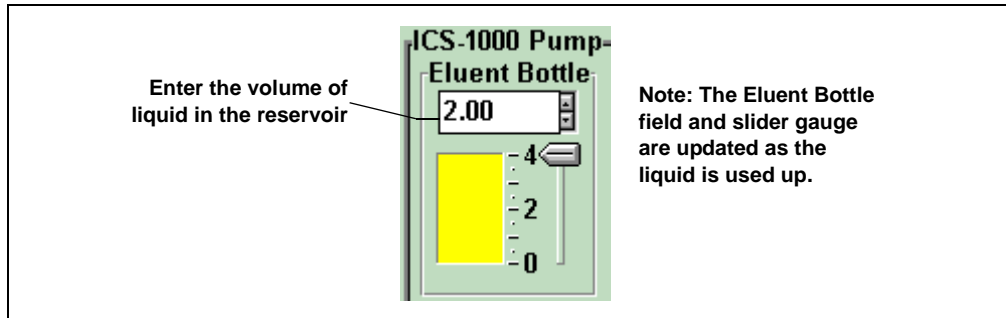

Figure 3-7. Setting the Eluent Level

3.4.6 Connect the Reservoir

If it is not already connected, connect the **ELUENT BOTTLE OUT** line from the reservoir cap to the **ELUENT IN** line, which extends from the plumbing and cable chase on the top of the ICS-1000.

3.5 Check All Connections

1. Make sure the eluent reservoir is filled and the tubing connecting the reservoir to the ICS-1000 tubing is securely connected.
2. Make sure the USB cable from the computer is connected to the USB receptacle on the ICS-1000 rear panel.

3.6 Prime the Pump

IMPORTANT

If you changed eluent or if the eluent lines are dry, prime the lines first with a syringe before following the procedure below to prime the pump. See [Section B.14](#) for instructions on priming the lines with a syringe.

1. Verify that the priming valve on the primary pump head (see [Figure 3-8](#)) is closed (turned all the way clockwise).
2. Open the waste valve on the secondary pump head by turning the knob one-quarter to one-half turn counterclockwise. Opening the valve directs the eluent flow path to waste and eliminates backpressure.

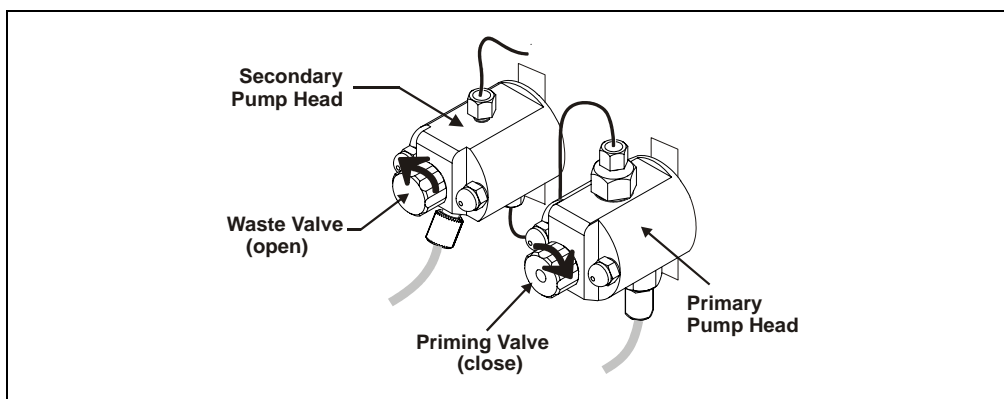

Figure 3-8. Priming the Pump

3. Press **Prime** on the Chromeleon Control panel. The pump will begin pumping at approximately 3 mL/min.
4. Continue priming the ICS-1000 until all air and previous eluent are purged and no air bubbles are exiting the waste line.
5. Press **Pump Off**.
6. Close the waste valve. **Do not overtighten**. The pump is now ready for operation.

3.7 Set System Operating Conditions

NOTE This section is an overview of the steps needed to start up the system and begin running samples. Actual operating parameters (flow rate, cell heater temperature, suppressor current, etc.) depend on the application to be run. Refer to the column manual for the required parameters for your application.

Set or verify system operating parameters from the Chromeleon Control panel. Operating parameters can also be set automatically by loading a Chromeleon sequence.

NOTE Clicking the System Startup button on the Chromeleon Control panel starts the pump and suppressor. The flow rate and suppressor current settings that were in effect when the system was shut down are restored.

1. Verify that the pump is on and set to the correct flow rate.
2. Verify that the suppressor current is on and that the setting is correct.
3. Verify that the cell heater is set to the correct value.
4. Verify that the column heater is set to the correct value.

3.8 Equilibrate the System and Verify Operational Status

1. Allow the system to equilibrate. During equilibration, the Chromeleon Control panel displays the background conductivity (the conductivity of the eluent before sample injection) and the system backpressure.
2. Monitor the background conductivity. Refer to the column manual for the appropriate background conductivity for your application.
3. Offset the background and zero the reading by clicking the **Autozero** button on the Chromeleon Control panel (see [Figure 3-4](#)).
4. Monitor the system pressure from the Control panel to make sure it is at the expected pressure for the installed column (refer to the column manual for details) and is stable.

- If the pressure is less than the expected amount, gas may be trapped in the system. To release the gas, remove the pump fitting on the injection valve port, labeled **P (2)**. Allow the air to escape and then reconnect the fitting.
 - If the pressure fluctuates by more than about 0.13 MPa (20 psi), prime the pump. See [Section 4.3](#) for additional troubleshooting information.
 - If the pressure is too high, there may be a restriction in the system plumbing (see [Section 3.6](#)). See [Section 4.7](#) for troubleshooting information.
5. Verify that the baseline conductivity is at the expected reading for your application and is stable. In general, it should be $<30 \mu\text{S}$ for a system set up for anion analyses and $<2 \mu\text{S}$ for a system set up for cation analyses. See [Section 4.12](#) for troubleshooting information if the conductivity is too high. See [Section 4.13](#) if the baseline is drifting or has excessive “noise” (large fluctuations in readings).
 6. Verify that the cell heater is at the set point and is stable. The temperature is at equilibrium when the **Set Temperature** and **Current Temperature** readings on the Control panel are the same.
 7. Verify that the column heater temperature (if installed) is at the set point and stable. The temperature is at equilibrium when the **Set Temperature** and **Current Temperature** readings on the Control panel are the same.

The system is now ready for sample processing.

3.9 Prepare Samples

NOTE Sample preparation can be performed while the system is equilibrating.

3.9.1 Collecting and Storing Samples

Collect samples in high density polyethylene containers that have been thoroughly cleaned with deionized (DI) water. Do not clean containers with strong acids or detergents because these can leave traces of ions on the container walls. The ions may interfere with the analysis.

If samples will not be analyzed on the day they are collected, filter them through clean $0.45 \mu\text{m}$ filters immediately after collection; otherwise, bacteria in the samples may cause the ionic concentrations to change over

time. Refrigerating the samples at 4° C (39° F) will reduce, but not eliminate, bacterial growth.

Analyze samples containing nitrite or sulfite as soon as possible. Nitrite oxidizes to nitrate, and sulfite to sulfate, thus increasing the measured concentrations of these ions in the sample. In general, samples that do not contain nitrite or sulfite can be refrigerated for at least one week with no significant changes in anion concentrations.

3.9.2 Pretreating Samples

Analyze rainwater, drinking water, and air particulate leach solutions directly with no sample preparation (other than filtering and possibly diluting).

Filter groundwater and wastewater samples through 0.45 µm filters before injection, unless samples were filtered after collection.

Before injection, pretreat samples that may contain high concentrations of interfering substances by putting them through Dionex OnGuard® cartridges. Refer to the *Installation and Troubleshooting Guide for OnGuard Cartridges* (Document No. 032943) for instructions.

3.9.3 Diluting Samples

Because the concentrations of ionic species in different samples can vary widely from sample to sample, no single dilution factor can be recommended for all samples of one type. In some cases (for example, many water samples), concentrations are so low that dilution is not necessary.

Use eluent or ASTM filtered, Type I (18-megohm) deionized water to dilute the sample. When using carbonate eluents, diluting with eluent minimizes the effect of the water dip at the beginning of the chromatogram. If you dilute the sample with eluent, also use eluent from the same lot to prepare the calibration standards. This is most important for fluoride and chloride, which elute near the water dip.

To improve the accuracy of early eluting peak determinations, such as fluoride, at concentrations below 50 ppb, dilute standards in eluent or spike the samples with concentrated eluent to minimize the water dip. For example, spike a 100 mL sample with 1.0 mL of a 100 X eluent concentrate.

3.10 Loading and Injecting Samples

The two techniques for loading samples into the sample loop are: (1) with an autosampler or (2) with a syringe or vacuum syringe through the injection port on the ICS-1000 front door.

For autosampler injections, the injection port tubing is disconnected from the ICS-1000 injection valve and replaced by the autosampler outlet tubing. Other setup requirements depend upon the model of autosampler.

Setup for an AS40 Autosampler

A relay or TTL connection is required for Chromeleon to control sample loading. See [Section B.18](#) for AS40 autosampler installation instructions.

Setup for an AS or AS50 (USB) Autosampler

To use an AS or AS50 (USB) autosampler with the ICS-1000, the following requirements must met:

- The ICS-1000 injection valve must be linked to the AS or AS50 (USB) in the Chromeleon timebase (see [Section B.17.2](#))
- An injection valve should not be installed in the AS or AS50 (USB)

See [Section B.17](#) for AS or AS50 (USB) autosampler connection instructions.

3.10.1 Loading Samples with a Syringe

1. Make sure the injection port on the ICS-1000 front door (see [Figure 2-1](#)) is connected to the sample port **S** (5) on the injection valve (see [Figure 3-9](#)).

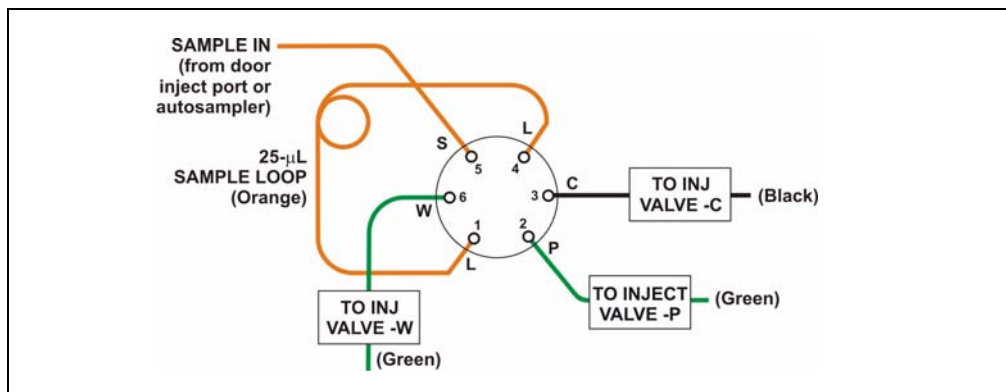

Figure 3-9. Injection Valve Connections

2. Fill the 1 cc syringe (P/N 016388) provided in the ICS-1000 Ship Kit (P/N 057905) with a calibration standard or sample.
3. Insert the syringe into the injection port on the ICS-1000 front door.
4. Verify that the injection valve is in the Load position.
5. Overfill the sample loop with several sample loop volumes. Excess sample will exit through the injection valve waste line.
6. Leave the syringe in the port.
7. Switch the injection valve to the Inject position (see [Section 3.10.4](#)).

3.10.2 Loading Samples with a Vacuum Syringe

1. Disconnect the waste line from port **W** (6) of the injection valve (see [Figure 3-9](#)) and attach a shorter line: 25 to 30 cm (10 to 12 inches) of PEEK or Teflon® tubing.
2. Place the free end of the line into the sample.
3. Verify that the injection valve is in the Load position.

4. Insert the 1 cc syringe (P/N 016388) provided in the ICS-1000 Ship Kit (P/N 057905) into the injection port on the ICS-1000 front door (see [Figure 2-1](#)) and pull out the plunger to draw the sample into the injection valve.
5. Switch the injection valve to the Inject position (see [Section 3.10.4](#)).

3.10.3 Loading Samples with an Autosampler

1. Verify that the autosampler output line is connected to port **S (5)** of the ICS-1000 injection valve.
2. Prepare and fill the sample vials and place them in the autosampler tray or cassette. Refer to the autosampler manual for detailed instructions.
3. The sample loading process depends on the autosampler. Refer to the autosampler manual for detailed instructions. In general, use one of the following methods:
 - Include the commands for controlling sample loading in a Chromeleon program. See the examples in [Section 3.10.5](#).
 - Enter the commands for loading the sample on the autosampler front panel.
4. Switch the injection valve to the Inject position (see [Section 3.10.4](#)).

3.10.4 Injecting Samples

After loading the sample in the sample loop, switch the injection valve to the Inject position, using one of the following methods:

- Manually: Click the **Inject** button on the Chromeleon Control panel (see [Figure 3-6](#)).
- Automatically: Include the Inject command in a Chromeleon program. See the examples in [Section 3.10.5](#).

3.10.5 Example Chromeleon Commands for Loading and Injecting Samples

The following examples show commands for loading and injecting samples using an AS or AS50 (USB)40 autosampler.

Example AS or AS50 (USB) Program Commands

0.000	Pump_ECD.Autozero		;Zero the baseline.
	Load		;Switch the valve to Load.
	Wait	CycleTimeState	;Wait for cycle time (if any).
	Inject		;Switch the valve to Inject.
	Wait	InjectState	;Wait for injection to complete.
	ECD_1.AcqOn		;Start data acquisition.
14.000	ECD_1.AcqOff		;Stop data acquisition.

Example AS40 Program Commands

-2.300	Pump_ECD_Relay_1.Closed	Duration=138.00	;Note 1
0.000	Pump_ECD.Autozero		;Note 2
	ECD_1.AcqOn		;Note 3
	Pump_InjectValve.InjectPosition	Duration=30.00	;Note 4
30.000	ECD_1.AcqOff		;Note 5

AS40 Program Command Notes:

1. Close the ICS-1000 **RELAY OUT 1**, which is connected to the AS40 **LOAD** relay. This signals the AS40 to load the sample.
2. Zero the baseline.
3. Start data acquisition.
4. Switch the valve to Inject.
5. Stop data acquisition.

3.11 Process Samples

Samples can be run either manually (one at a time) or automatically (in groups or “batches”).

3.11.1 Manual Sample Processing

To process samples manually, select operating parameters and commands from the Chromeleon menu bar, toolbars, and Control panel. Commands are executed as soon as they are entered.

1. Complete the steps in Sections [3.2](#) through [3.8](#) to prepare for operation and start up the ICS-1000.
2. Load the sample, using a syringe, vacuum syringe, or autosampler (see [Section 3.10](#)).
3. Select **Control>Acquisition On**. Chromeleon records the signal supplied by the detector and displays the signal plot on the Control panel.
4. Click the **Autozero** button on the Control panel.
5. Inject the sample (see [Section 3.10.4](#)).
6. Monitor the chromatogram on the Control panel and select **Acquisition Off** from the Control menu when sample data is collected.

NOTE Data from Chromeleon manual processing is saved in the **MANUAL** sequence folder under the local datasource. This data is overwritten each time a

new manual sample is processed. To save the data from a manual run, select the MANUAL folder, select Save As from the File menu, and enter a new name for the sequence.

3.11.2 Automatic (Batch) Sample Processing

For batch processing, you use Chromeleon to create a list of samples (a sequence) to be processed automatically. For each sample, the sequence includes a program with commands and parameters for controlling the ICS-1000, controlling the autosampler (if used), and acquiring sample data. The sequence also includes a quantification method for peak identification and area determination. Additional sample processing parameters are included in the sequence (for example, the sample name, sample type, injection volume, etc.).

After defining the sequence, you can start batch processing.

1. Complete the steps in Sections [3.2](#) through [3.8](#) to prepare for operation and to start up the ICS-1000.
2. Create a new sequence or modify an existing one.

To create a new sequence:

- a. In the Browser, select **File>New**. Select **Sequence (using Wizard)** and click **OK**.
- b. Complete the steps in the Sequence Wizard, adding the desired number of samples and standards to the list. For help with any of the steps, click the **Help** button on the Sequence Wizard page.

NOTE A simple way to get started is to select the “Use Application Template” option in Step 4 of the Sequence Wizard. This option lets you select a column and suppressor type from a list of applications. The Wizard then copies a program and quantification method, appropriate for the selected application, to the sequence folder and adds them to the sequence definition.

- To start the sample processing, make sure the System Control panel is open (see [Section 3.3](#)) and is the active window. Then, select **Batch>Edit**. The Batch dialog box opens (see [Figure 3-10](#)).

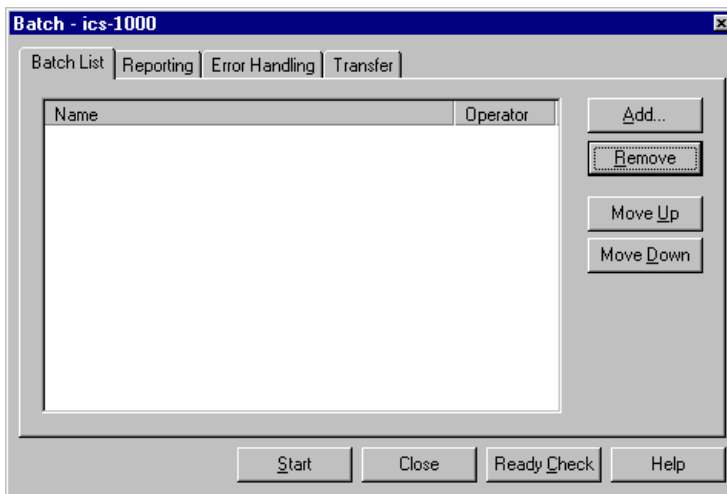

Figure 3-10. Batch Dialog Box

- Click the **Add** button on the **Batch List** tab and add the sequence you created in [Step 2](#). See [Figure 3-11](#) for an example.

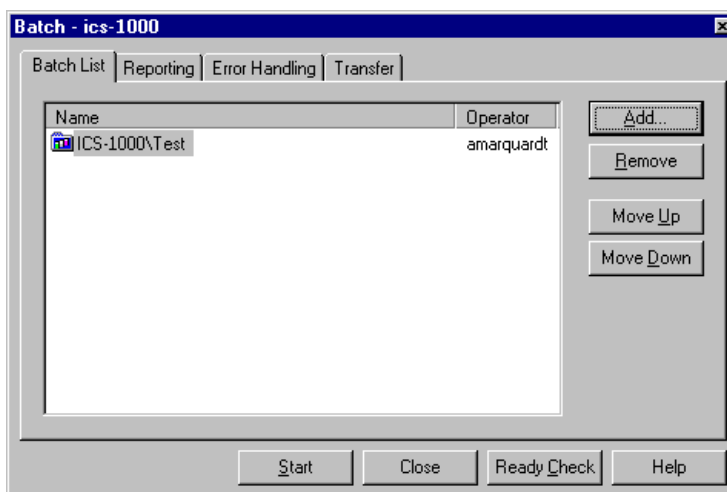

Figure 3-11. Batch Dialog Box with an Example Sequence Added to the Batch List

- To start the batch, click **Start**.

3.12 Maintenance

This section describes routine maintenance procedures that users may perform. All other maintenance procedures must be performed by Dionex personnel.

As Needed

- Regularly check the eluent reservoir and refill when needed.
- Make fresh eluent as needed.

Daily

- Check the ICS-1000 component mounting panel (see [Figure 2-4](#)) for leaks or spills. Wipe up spills. Isolate and repair leaks (see [Section 4.2](#)). Rinse off any dried eluent with deionized water.
- Check the waste container daily and empty when needed.

Weekly

- Once a week, check fluid lines for crimping or discoloration. Relocate any pinched lines. Replace damaged lines.
- Check the junctions between the pump heads and the pump casting for evidence of liquid leaks. If the piston seal wash tubing is not connected, check the drain tubes at the rear of the pump heads for evidence of moisture. Normal friction and wear may gradually result in small liquid leaks around the piston seal. If unchecked, these leaks can gradually contaminate the piston housing, causing the pump to operate poorly. If leaks occur, replace the piston seals (see [Section 5.6](#)).
- Check the end-line filter (P/N 045987) and change if needed. When new, end-line filters are pure white. If the system is in continuous operation, change the end-line filter weekly, or whenever it becomes discolored. Replace the filter more often if bacterial buildup is visible or if the eluent does not contain solvent.

NOTE It is especially important to regularly replace end-line filters when using aqueous eluents, which may contaminate the filter with bacteria or algae. The bacterial buildup may not be visible.

Every Six Months

- Calibrate the cell (see [Section 5.1.2](#)).
- Calibrate the vacuum degas assembly (see [Section 5.1.4](#)).
- Replace the pump piston rinse seals and piston seals (see [Section 5.6](#)).

Yearly

- Rebuild the injection valve (see [Section 5.4](#)).
- Replace the AS40 Automated Sampler tip and tubing. The AS40/ASM Maintenance Kit (P/N 055647) contains all of the components required to replace the sampling tip and the tubing between the tip and the injection valve. Instructions are included with the kit.
- Perform the AS or AS50 (USB) preventive maintenance procedure. The AS or AS50 (USB) Maintenance Kit (P/N 060581) contains all of the required components and instructions for performing the procedure.



4 • Troubleshooting

This chapter is a guide to troubleshooting minor issues that may arise during operation of the ICS-1000. Turn to the section of this chapter that best describes the operating problem or symptom that has been observed. Each section lists possible causes of the problem or symptom in order of probability. A systematic troubleshooting approach is the most effective way to determine the root cause.

If you are unable to resolve a problem by following the instructions here, contact Dionex Technical Support. In the U.S., call 1-800-346-6390. Outside the U.S., call the nearest Dionex office. Please have this chapter at hand when talking with Technical Support personnel.

4.3 Error Messages

The Moduleware (the instrument control firmware installed in each ICS-1000 module) periodically checks the status of certain parameters. If a problem is detected, it is reported to Chromeleon and logged in the Audit Trail. Each error message is preceded by an icon that identifies the seriousness of the underlying problem (see the table below). You can change the severity level assigned to a problem whenever appropriate.

Icon	Severity Level	Description
	Warning	A message is displayed in the Audit Trail, but the current run is not interrupted.
	Error	A message is displayed in the Audit Trail, and the system attempts to correct the problem (sometimes by using an alternative parameter). An Error never interrupts the current analysis; however, if it occurs during the Ready Check, the analysis will not be started.
	Abort	A message is displayed in the Audit Trail, and the running batch is aborted.

ICS-1000 Ion Chromatography System

The table below lists the most frequently observed ICS-1000 error messages. For troubleshooting assistance, refer to the page indicated in the table.

Alarms and Error Conditions	See
Column heater exceeds safe temperature	page 3
Column heater open circuit	page 3
Column heater short circuit	page 3
Degas calibration failed	page 3
Hardware not present	page 4
Leak sensor wet	page 4
Load/inject valve error	page 5
Option not installed	page 5
Pressure slope calibration error	page 5
Pump motor lost control	page 6
Pump pressure hardware error	page 6
Pump over pressure	page 6
Pump under pressure	page 7
Suppressor over current	page 7
Suppressor over voltage	page 8
Suppressor over power	page 8
Suppressor not connected	page 8
Suppressor stopped for flow rate	page 9

Table 4-4. ICS-1000 Alarms and Error Messages Summary

4.1 Troubleshooting Error Messages



COLUMN HEATER EXCEEDS SAFE TEMPERATURE

This error occurs when the column heater temperature is higher than the maximum allowed. This error may occur if the ICS-1000 is operating in an extreme environment (greater than 40 °C (104 °F)).

To troubleshoot:

Refer to [Section A.3](#) for environmental specifications.



COLUMN HEATER OPEN CIRCUIT

This error occurs when the column heater is unplugged from the component panel.

To troubleshoot:

1. Check that the column heater is plugged into the component panel.
2. If the error persists, the column heater may be faulty. Replace the column heater (see [Section 5.11](#)).



COLUMN HEATER SHORT CIRCUIT

This error occurs when there is a short circuit on the thermistor input used to measure the column heater temperature. This error indicates a faulty column heater.

To troubleshoot:

Replace the column heater (see [Section 5.11](#)).



DEGAS CALIBRATION FAILED

This error occurs when the degas vacuum does not reach the expected level during calibration.

To troubleshoot:

1. Retry the calibration.
2. If calibration still fails, the vacuum degas assembly may need to be replaced. Contact Dionex for assistance.



HARDWARE NOT PRESENT

This error indicates a problem in the ICS-1000 electronics.

To troubleshoot:

- Contact Dionex for assistance. The ICS-1000 electronics components cannot be serviced by the user.



LEAK SENSOR WET

The leak sensor is installed in the drip tray at the bottom of the component panel (see [Figure 2-4](#)). If liquid accumulates in the tray, the sensor signals the problem and the “Leak sensor wet” error message appears.

To troubleshoot:

1. Locate the source of the leak by visually inspecting the tubing, fittings, and components on the component panel.
2. Tighten fittings or replace tubing and fittings as required. Refer to [Section 4.2](#) for detailed troubleshooting of various types of leaks.
3. After fixing the leak, dry the drip tray thoroughly to prevent the leak sensor from triggering additional error messages.



LOAD/INJECT VALVE ERROR

If the injection valve fails to switch position within 1 second of being toggled, the ICS-1000 Moduleware reports an error to Chromeleon and the “Load/Inject valve error” message appears.

To troubleshoot:

1. If a sequence is being executed, terminate the sequence by selecting **Batch>Stop** on the Chromeleon menu.
2. Turn off the ICS-1000 power briefly and then restart.
3. Try to toggle the valve from Load to Inject by clicking the **Load** and **Inject** buttons on the ICS-1000 Control panel in Chromeleon.
4. If the problem persists, contact Dionex for assistance.



OPTION NOT INSTALLED

This error occurs if a command is issued to control an option that is not installed.

To troubleshoot:

- Check the Chromeleon Server Configuration program to verify that the option is enabled.



PRESSURE SLOPE CALIBRATION ERROR

This error occurs if you try to calibrate the pressure slope when the pressure is less than 3 MPa (500 psi).

To troubleshoot:

- Contact Dionex for assistance.



PUMP MOTOR LOST CONTROL

This error indicates a problem in the pump controller electronics.

To troubleshoot:

- Contact Dionex for assistance. The ICS-1000 electronics components cannot be serviced by the user.



PUMP PRESSURE HARDWARE ERROR

This error indicates a problem in the pump controller electronics.

To troubleshoot:

- Contact Dionex for assistance. The ICS-1000 electronics components cannot be serviced by the user.



PUMP OVER PRESSURE

If the system pressure exceeds the set limit for at least 0.5 seconds, this error message appears and the pump stops. Pressure limits can be set in the Chromeleon Server Configuration or in the control program.

To troubleshoot:

1. Check for blockages in the liquid lines by working your way backward from the cell to the pump. See [Figure 2-6](#) for the system flow schematic.
2. Check that the flow rate is set to the correct value.
3. Check that the high pressure limit is set to the correct value.
4. Restart the pump.



PUMP UNDER PRESSURE

If the system pressure falls below the low pressure limit, the pump stops and this error message appears. Pressure limits can be set in the Chromeleon Server Configuration or in the control program.

To troubleshoot:

1. Make sure the eluent reservoir is full.
2. Check for liquid leaks (see [Section 4.2](#)).
3. Check that the waste valve is closed.
4. Prime the pump (see [Section B.14](#)).
5. Restart the pump.



SUPPRESSOR OVER CURRENT

This error may be caused by an expended or dirty suppressor or by a malfunction in the suppressor controller electronics.

To troubleshoot:

1. Follow the instructions in the suppressor manual to regenerate the suppressor. Suppressor manuals are included on the Dionex Reference Library CD-ROM (P/N 053891).
2. Follow the instructions in the suppressor manual to clean the suppressor.
3. If a malfunction in the suppressor controller is suspected, contact Dionex for assistance. The ICS-1000 electronics components cannot be serviced by the user.



SUPPRESSOR OVER VOLTAGE

This error occurs if you turn on the suppressor but the ICS-1000 cannot establish a connection with the suppressor.

To troubleshoot:

1. Check the suppressor cable connection (see [Section 5.10](#)).
2. If the error persists, replace the suppressor (see [Section 5.10](#)).



SUPPRESSOR OVER POWER

This error occurs when, in order to maintain the selected current, the ICS-1000 is required to apply a higher voltage than the suppressor can support.

To troubleshoot:

- Reduce the flow rate.
- Rehydrate the suppressor. Refer to the suppressor manual for instructions. Suppressor manuals are included on the Dionex Reference Library CD-ROM (P/N 053891).
- If the error persists, replace the suppressor (see [Section 5.10](#)).



SUPPRESSOR NOT CONNECTED

This error occurs if you turn on the suppressor and the ICS-1000 cannot establish a connection with the suppressor.

To troubleshoot:

1. Check the suppressor cable connection (see [Section 5.10](#)).
2. If the error persists, contact Dionex for assistance. There may be a problem in the suppressor controller electronics. The ICS-1000 electronics components cannot be serviced by the user.

SUPPRESSOR STOPPED FOR ZERO FLOW RATE

This error message appears when you click the **Shutdown** button on the Chromeleon Control panel. The message also appears anytime you turn off the pump flow while the suppressor is on. The suppressor is automatically turned off to prevent damage to the suppressor.

To troubleshoot:

- If the pump stopped unexpectedly, see [Section 4.5](#) for pump troubleshooting information.

4.2 Liquid Leaks

- **Leaking fitting**

Locate the source of the leak. Tighten or, if necessary, replace the liquid line connection (see [Section 5.3](#)). Refer to *Installation of Dionex Liquid Line Fittings* (Document No. 031432) for tightening requirements. The manual is on the Dionex Reference Library CD-ROM (P/N 053891).

- **Broken liquid line**

Replace the line and fittings with the same length and internal diameter tubing (see [Section 5.3](#)).

- **Blocked or improperly installed line**

Make sure the lines are not crimped or otherwise blocked. Also, if the blocked line is a waste line, make sure it is not elevated at any point after it exits the ICS-1000. If a line is blocked, replace it (see [Section 5.3](#)).

- **Loose pump check valve**

1. Make sure the check valves are firmly seated in the pump head. If they are not, tighten them carefully with an open-end wrench just until the leak stops.
2. If the leak persists, replace the check valve (see [Section 5.5](#)).

- **Leaking seal wash port**

Leaking from the seal wash port indicates a leaking piston seal. Replace the seal (see [Section 5.6](#)).

- **Damaged pump piston seal**
 1. Replace the piston seal (see [Section 5.6](#)).
 2. If the leak persists, replace the piston (see [Section 5.7](#)).
- **Pump head not tight against casting**

Carefully tighten the pump head mounting nuts just until the leak stops. **DO NOT OVERTIGHTEN!**
- **Leaking pressure transducer**
 1. Make sure the liquid line connections into the pressure transducer are tight. Refer to *Installation of Dionex Liquid Line Fittings* (Document No. 031432) for tightening requirements. The manual is on the Dionex Reference Library CD-ROM (P/N 053891). Replace any damaged fittings.
 2. If the pressure transducer continues to leak, contact Dionex for assistance. The pressure transducer cannot be serviced by the user.
- **Leaking pump head waste valve**

Make sure the waste valve is closed. To close the valve, turn the knob clockwise, and tighten fingertight. **DO NOT OVERTIGHTEN!**
Overtightening may damage the valve and the pump head.

If the leak persists, replace the waste valve O-ring (see [Section 5.8](#)).
- **Leaking suppressor**

Refer to the suppressor manual for troubleshooting procedures. Suppressor manuals are included on the Dionex Reference Library CD-ROM (P/N 053891).
- **Leaking injection valve**
 1. Make sure the liquid line connections to the transducer are tight. Refer to *Installation of Dionex Liquid Line Fittings* (Document No. 031432) for tightening requirements. The manual is on the Dionex Reference Library CD-ROM (P/N 053891). Replace any damaged fittings.
 2. Liquid leaks from behind the valve stator may indicate a scratched rotor seal. Rebuild the injection valve (see [Section 5.4](#)).

- **Leaking cell**
 1. Check the waste lines for blockage; trapped particles can plug the lines and cause a restriction and/or leak. If necessary, clear the waste lines by reversing the direction of flow.
 2. Make sure the plumbing downstream from the cell is clear; a blockage may overpressurize the cell, causing it to leak. If the problem continues, contact Dionex for assistance.

4.3 Pump Difficult to Prime or Loses Prime

Excessive pressure fluctuations (more than 3% difference from one pressure reading to the next) indicate that the pump is out of prime.

- **Empty eluent reservoir and/or no eluent connected**

Fill the reservoir. Make sure all connections are secure.

- **Eluent improperly or insufficiently degassed**

If the ICS-1000 does not contain a vacuum degas assembly, degas the eluent manually (see [Section 3.4.2](#)).

If the ICS-1000 contains a vacuum degas assembly, check the degas settings:

1. Open the Chromeleon Server Configuration program, select the ICS-1000 device icon under the timebase, and select **Edit>Properties** (or double-click the ICS-1000 device icon).

2. Select the **Options** tab (see [Figure 4-1](#)).

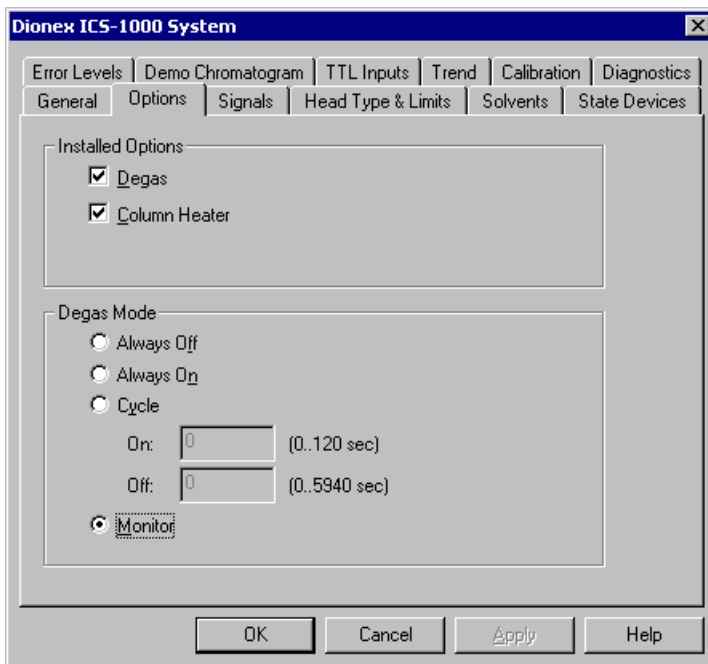

Figure 4-1. ICS-1000 Server Configuration Properties: Options

3. Under **Installed Options**, verify that the **Degas** check box is selected.
 4. Check the **Degas Mode** settings. Select either the **Monitor** option or the **Cycle** option. If you select **Cycle**, set the time **On** to 30 seconds and the time **Off** to 10 minutes. If **Cycle** is already selected, try increasing the time on or decreasing the time off.
- **End-line filter is dirty or clogged**

When new, end-line filters (P/N 045987) are pure white. If the system is in continuous operation, change the end-line filter weekly, or whenever it becomes discolored. Replace the filter more often if bacterial buildup is visible or if the eluent does not contain solvent.

NOTE It is especially important to regularly replace end-line filters when using aqueous eluents, which may contaminate the filter with bacteria or algae. The bacterial buildup may not be visible.

- **Blockages in inlet tubing**

Kinked or clogged tubing causes the pump to be “starved” for eluent. Replace the tubing and fittings (see [Section 5.3](#)).

- **Dirty check valve**

Clean or replace the pump check valve (see [Section 5.5](#)).

- **Liquid leaks at junction between pump head and pump casting**

Use the open-end wrench (P/N 014605) provided in the ICS-1000 Ship Kit (P/N 057905) to tighten the two acorn nuts that attach the pump head to the pump housing (see [Figure 5-4](#)). Tighten the nuts evenly (12 in-lb torque).

If the leak persists, replace the piston seal (see [Section 5.6](#)).

- **Liquid leaks from the seal wash port**

Replace the piston seal (see [Section 5.6](#)).

- **Scratched pump piston**

Check the pump pistons for scratches and replace if necessary (see [Section 5.7](#)).

4.4 Pump Does Not Start

- **No power (front Power LED indicator is not lit)**

Check that the power cord is plugged in.

Check the main power fuses and replace if needed (see [Section 5.16](#)).

- **No communication between ICS-1000 and Chromeleon**

Verify that the USB cable is connected correctly. See [Section B.5](#) for installation instructions.

- **Pump is turned off**

Turn on the pump from the Chromeleon Control panel.

- **Flow rate is set to 0**

Set the flow rate from the Chromeleon Control panel.

4.5 No Flow

- **Pump waste or priming valve open (see [Figure 4-2](#)).**

Close the valves by turning the knobs clockwise until fingertight. **DO NOT OVERTIGHTEN! Overtightening may damage the valve and the pump head.**



Figure 4-2. Waste and Priming Valves

- **Flow rate is set to 0**

Set the flow rate from either the Chromeleon Control panel.

- **Eluent valve is closed**

Open the eluent valve from either the Chromeleon Control panel.

- **Pump not primed**
Prime the pump (see [Section B.14](#)).
- **Broken pump piston**
Replace the piston (see [Section 5.7](#)).

4.6 Erratic Flow/Pressure Reading

- **Pump needs priming**
Prime the pump (see [Section B.14](#)).
- **Damaged piston seal**
Replace the piston seal (see [Section 5.6](#)).
- **Dirty pump check valve**
Clean or replace the check valve (see [Section 5.5](#)).
- **Leaking liquid lines or fittings**
Check the liquid lines and fittings for small leaks. Tighten or, if necessary, replace the liquid line connection (see [Section 5.3](#)). Refer to *Installation of Dionex Liquid Line Fittings* (Document No. 031432) for tightening requirements. The manual is on the Dionex Reference Library CD-ROM (P/N 053891).

4.7 Excessive System Backpressure

- **Restriction in the system plumbing**
Check all liquid lines for crimping or blockage. Make sure the ferrule fittings are not overtightened onto tubing. Refer to *Installation of Dionex Liquid Line Fittings* (Document No. 031432) for details. The manual is on the Dionex Reference Library CD-ROM (P/N 053891). If you have trouble isolating the restriction, refer to [Section 5.2](#).
- **Plugged or damaged fitting**
Isolate the faulty fitting by loosening fittings one by one until the pressure returns to normal. Repair or replace the fitting (see [Section 5.3](#)).

- **Flow rate through the columns too high**

Set the correct rate for your application. If an incorrect flow rate calibration is suspected, calibrate the flow (see [Section 5.1.3](#)).

- **Clogged column bed supports**

Refer to the instructions in the column manual for troubleshooting guidance. Column manuals are included on the Dionex Reference Library CD-ROM (P/N 053891).

- **Contaminated columns**

Clean the columns as instructed in the column manual.

- **Plugged injection valve passages**

Rebuild the injection valve (see [Section 5.4](#)).

4.8 Peak “Ghosting”

“Ghosting” is the appearance of extraneous peaks in a chromatogram. These may be late-eluting peaks from a previous injection, or they may be the result of a contaminated standard or eluent, or a malfunctioning injection valve. These peaks may co-elute with peaks of interest, resulting in nonreproducible peak heights/areas.

- **Insufficient time between sample injections**

Wait until the previous sample has been completely eluted before making another injection.

- **Insufficient flush between samples**

Flush the sample loop with at least 10 loop volumes of deionized water or sample between sample injections.

- **Incorrect or contaminated standards**

Remake standards.

- **Incorrect or contaminated eluent**

Remake the eluent according to the instructions in the column manual. Column manuals are included on the Dionex Reference Library CD-ROM (P/N 053891).

Install or replace the end-line filter on the end of the deionized water line (see [Section 3.4.3](#)).

- **Malfunctioning injection valve**
 1. Rebuild the injection valve (see [Section 5.4](#)).
 2. If the valve leak persists, contact Dionex for assistance.

4.9 Nonreproducible Peak Height or Retention Time

- **Column overloading**

Dilute the sample (see [Section 3.9](#)).
- **Liquid leaks**

Locate and eliminate the leaks (see [Section 4.2](#)).
- **Incomplete or imprecise filling of the sample loop**
 1. Fill the sample loop until excess sample exits the waste line.
 2. Inspect the 1-cc syringe (P/N 016388) and replace if damaged.
- **Pump not primed properly**

Prime the pump (see [Section B.14](#)).

4.10 Abnormal Retention Time or Selectivity

- **Contaminated or incorrect eluent**

Remake the eluent, using concentrated eluent and ASTM filtered, Type I (18-megohm) deionized water.
- **Contaminated or degraded sample**

Take appropriate precautions when preparing and storing samples to prevent contamination and degradation (see [Section 3.9](#)).
- **Contaminated column**
 1. Clean the column as instructed in the column manual. Column manuals are included on the Dionex Reference Library CD-ROM (P/N 053891).
 2. If cleaning is unsuccessful, replace the column.

4.11 No Cell Response

- **Cell not properly installed**

Verify that the cell front cover is flush against the component panel. If necessary, tighten the two mounting screws. When the cell is correctly installed and the screws tightened, an electronics connector on the cell plugs into a receptacle inside the ICS-1000.

- **No flow from pump**

This condition has several possible causes. See [Section 4.4](#) and [Section 4.5](#) for details.

- **Cell electronics malfunctioning**

Use the Chromeleon Wellness Panel diagnostics to test the electronics (see [Section 5.1](#) and the Chromeleon online Help for instructions). If the variance reading is outside the tolerance range (less than 1 μ S), the electronics are malfunctioning. Contact Dionex for assistance. The ICS-1000 electronics cannot be serviced by the user.

4.12 High Cell Output

- **Background not suppressed by suppressor**

Verify that the suppressor is turned on and the current is set to the correct value. Refer to the suppressor manual for additional troubleshooting guidance. Suppressor manuals are included on the Dionex Reference Library CD-ROM (P/N 053891).

- **Sample concentration too high**

Dilute the sample [Section 3.9.3](#).

- **Wrong eluent**

Check that you are using the correct eluent for your application.

- **Background conductivity not offset from conductivity reading**

Before making an injection, allow the background conductivity to equilibrate, and then press **Autozero** on the Chromeleon Control panel.

- **Cell out of calibration**
Recalibrate the cell (see [Section 5.1.2](#)).

4.13 Baseline Noise or Drift

- **Flow system leak; erratic baseline**
Check all fittings and liquid lines for leaks. Tighten or, if necessary, replace all liquid line connections. Refer to *Installation of Dionex Liquid Line Fittings* (Document No. 031432) for tightening requirements. The manual is on the Dionex Reference Library CD-ROM (P/N 053891).
- **Trapped gases**
Release any trapped gases in the cell by loosening the lines to and from the cell and then retightening them. Also loosen and retighten the fittings to and from the suppressor eluent ports.
- **Pump not properly primed**
Prime the pump (see [Section B.14](#)).
- **Contaminated or incorrect eluent**
Remake the eluent, using concentrated eluent and ASTM filtered, Type I (18-megohm) deionized water.
- **Rapid changes in ambient temperature**
Make sure the ambient temperature is between 4 and 40 °C (40 and 104 °F).
Make sure air conditioning and heating vents are directed away from the ICS-1000 and the ICS-1000 front door is closed.
- **Insufficient system equilibration following changes to operating parameters; especially apparent when operating at high sensitivities**
Allow a longer system equilibration time (up to 2 hours) before starting operation.
- **Incorrect suppressor operating conditions**
Refer to the suppressor manual for troubleshooting information. Suppressor manuals are included on the Dionex Reference Library CD-ROM (P/N 053891).

- **Cell above or below temperature**
Contact Dionex for assistance.
- **Damaged piston seal**
Replace the piston seal (see [Section 5.6](#)).

4.14 Vacuum Degas Assembly Does Not Run

- **Degas option not enabled in Chromeleon**
 1. Open the Chromeleon Server Configuration program. Select the ICS-1000 device icon under the timebase and select **Edit>Properties** (or double-click the ICS-1000 device icon).

Select the **Options** tab (see [Figure 4-3](#)).

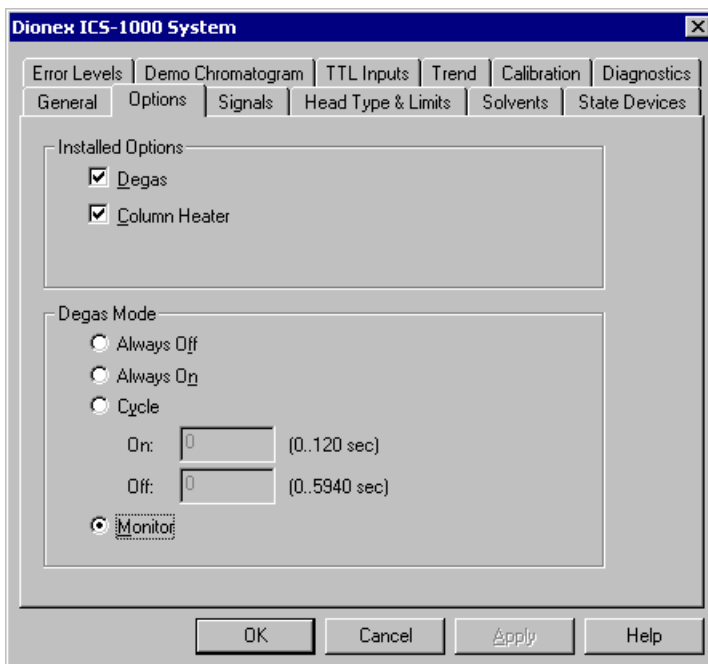

Figure 4-3. ICS-1000 Server Configuration Properties: Options.

2. Under **Installed Options**, verify that the **Degas** check box is selected.

3. Under **Degas Mode**, verify that the **Always Off** option is *not* selected. If it is, select one of the following settings:
 - **Cycle**, and select **On**: 30 seconds and **Off**: 10 minutes
 - **Monitor**
4. If the **Degas Mode** settings are correct, but the degas assembly still does not run, test the assembly by selecting the **Always On** option. The pump should turn on immediately. If it does not, the vacuum degas assembly may need to be replaced. Contact Dionex for assistance.

IMPORTANT

Select the **Degas Mode, Always On** option only when testing the vacuum degas assembly. Do not select the **Always On** option for routine use.

5. If the degas pump runs when you select **Always On**, but does not run when **Monitor** mode is selected, recalibrate the degas assembly (see [Section 5.1.4](#)).

This chapter describes ICS-1000 service and repair procedures that the user can perform. All procedures not included here, including electronics-related repair procedures, must be performed by Dionex personnel. For assistance, contact Dionex Technical Support. In the U.S., call 1-800-346-6390. Outside the U.S., call the nearest Dionex office.

Before replacing any part, refer to the troubleshooting information in [Chapter 4](#) to isolate the cause of the problem.

IMPORTANT

Substituting non-Dionex parts may impair ICS-1000 performance, thereby voiding the product warranty. Refer to the warranty statement in the Dionex Terms and Conditions for more information.

5.1 Diagnostic and Calibration Procedures

Diagnostic and calibration procedures are performed from the Chromeleon Wellness Panel (see [Figure 5-1](#)).

For an overview of the Wellness Panel features, see [Section 5.1.1](#). For instructions on performing calibration and diagnostic procedures, see the following sections:

- Calibrating the Conductivity Cell ([Section 5.1.2](#))
- Calibrating the Flow Rate ([Section 5.1.3](#))
- Calibrating the Vacuum Degas Assembly ([Section 5.1.4](#))

5.1.1 Chromeleon Wellness Panel Overview

NOTE Do not open a System Wellness Control panel if the name includes "Service.pan." These Wellness panels are reserved for use by Dionex Service Representatives.

To Open the Wellness Panel

1. Open the Chromeleon Browser and expand the **Dionex Templates** folder.
2. Expand the **Panels** folder and then the **Wellness** folder.
3. In the right pane of the Browser window, double-click **ICS-1000_1500_2000_Wellness_user.pan**. The Wellness Panel appears.
4. Open the **Control** menu and click the name of the ICS-1000 timebase at the bottom of the menu. This connects the Wellness Panel to the ICS-1000 and enables the controls on the panel.

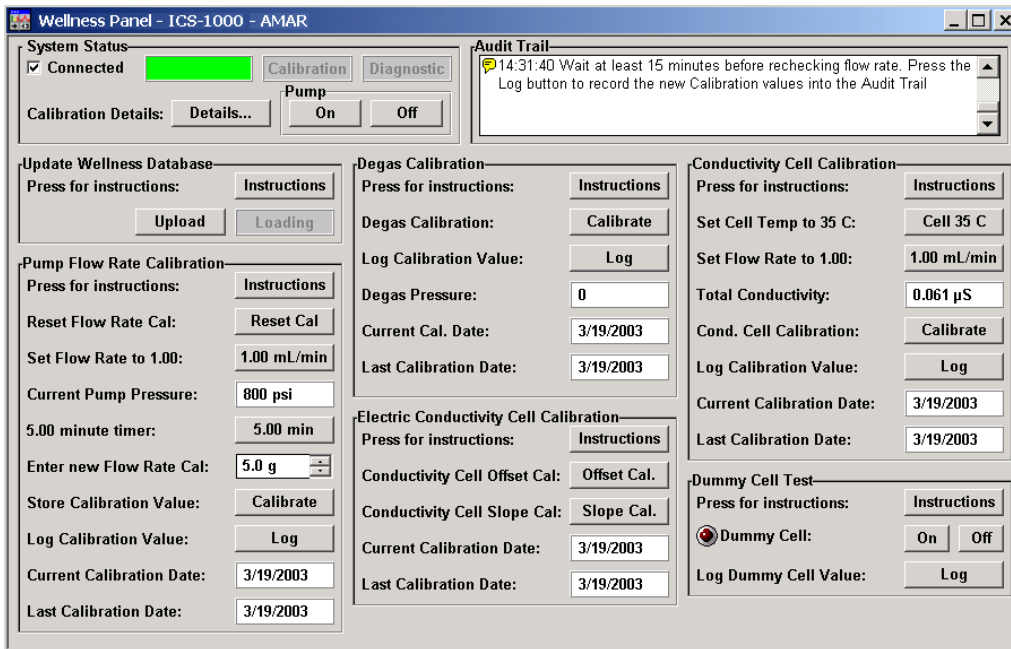

Figure 5-1. Chromeleon Wellness Panel

Use the Wellness Panel to perform the following functions:

- Calibrate the pump flow rate
- Calibrate the vacuum degas assembly
- Calibrate the conductivity cell
- Test the conductivity cell electronics, using a dummy cell
- Upload calibration values from the ICS-1000 to the Chromeleon Wellness database

5.1.2 Calibrating the Conductivity Cell

When to Calibrate

- After every 6 months of use

NOTE Do not use this procedure to calibrate a new cell. If you are replacing a cell, see the instructions in [Section 5.9](#) to install the new cell and calibrate it.

Items Needed	Description
1.0 mM KCl solution	Prepare by dissolving 0.07456 g of reagent-grade KCl in 1 liter of 18-megohm DI water.
Backpressure tubing to provide at least 7 MPa (1000 psi)	Use 0.076-mm (0.003-in) ID yellow PEEK tubing (P/N 049715).

1. Open the ICS-1000 Wellness Panel in Chromeleon (see [Section 5.1.1](#)).
2. On the Wellness Panel under **Electric Conductivity Cell Calibration**, click **Offset Cal**.
3. When the offset calibration is complete, click **Slope Cal** on the Wellness Panel.
4. Disconnect the pump output line from the injection valve.
5. Disconnect the line from the suppressor **ELUENT OUT** port to the cell inlet and connect the pump output line directly to the cell inlet.
6. Verify that the backpressure is at least 7 MPa (1000 psi).
7. On the Wellness Panel under **Conductivity Cell Calibration**, click **Cell 35 C**. Allow the cell to reach this temperature and then wait an additional 5 minutes to let it stabilize.
8. Select **1.00 mL/min** to begin pumping 1.00 mM KCl through the cell at 1.0 mL/min.
9. Wait until the total conductivity reading stabilizes (in about 15 minutes) and then select **Calibrate** on the Wellness Panel.

After calibration, the conductivity reading should be $147.00 \pm 2 \mu\text{S}$ and the cell constant should be between 120 and 180. If this is not the case, contact Dionex for help.

10. Click **Log** to record the new calibration values in the Audit Trail.
11. Flush the KCl solution from the system by pumping deionized water through the cell. When the conductivity drops to less than $1 \mu\text{S}/\text{cm}$, stop the pump.
12. Reconnect the pump to the injection valve and reconnect the line from the suppressor to the cell inlet.

5.1.3 Calibrating the Flow Rate

When to Calibrate

If you run the ICS-1000 Operational Qualification or Performance Qualification and it fails.

Items Needed

- 0.076-mm (0.003-in) ID yellow PEEK tubing (P/N 049715) to create 14 ± 2 MPa (2000 ± 300 psi) of backpressure (if needed)
- High purity ASTM filtered, Type I (18 megohm-cm) deionized water
- Balance capable of weighing more than 10 g with 0.001 g readability
- Tared beaker

To Calibrate

1. Open the ICS-1000 Wellness Panel in Chromeleon (see [Section 5.1.1](#)).
2. Verify that there is 14 ± 1.4 MPa (2000 ± 200 psi) of backpressure.
3. On the Chromeleon Wellness Panel under **Pump Flow Rate Calibration**, select **Reset Cal**.
4. Select **1 mL/min** to set the flow rate and begin pumping deionized water.
5. Allow the pump to stabilize for 20 minutes.
6. Click **5.00 min** to start the timer. Immediately start collecting water into the tared beaker.
7. Collect the water for exactly 5.00 minutes.
8. Enter the weight of the water (in grams).
9. Click **Calibrate** to download the value to the ICS-1000.
10. To recheck the value, wait at least 15 minutes, and then repeat the calibration.
11. Click **Log** to record the new calibration value in the Audit Trail.

5.1.4 Calibrating the Vacuum Degas Assembly

When to Calibrate

- After every 6 months of use
1. Open the ICS-1000 Wellness Panel in Chromeleon (see [Section 5.1.1](#)).
 2. On the Wellness Panel under **Degas Calibration**, select **Calibrate**. The degas pump runs for 90 seconds to allow a vacuum to be created. After 90 seconds, the vacuum degas pressure reading is recorded. When the vacuum degas assembly is running in monitor mode, this calibration value is used to determine when to turn on the degas pump.
 3. Click **Log** to record the new calibration value in the Audit Trail.

5.2 Isolating a Restriction in the Liquid Lines

A restriction in the liquid plumbing will cause excessive system backpressure.

1. Begin pumping eluent through the system (including the columns).
2. Follow the ICS-1000 flow schematic in [Figure 5-2](#) and work backward through the system, beginning at the suppressor **Regen Out** port. One at a time, loosen each fitting and observe the pressure. The connection at which the pressure drops abnormally indicates the point of restriction.

NOTE The numbers on the ICS-1000 flow schematic indicate the order in which liquid flows through the system components.

If the restriction has caused such high pressure that the system cannot be operated, you must work forward through the flow schematic, adding parts one at a time until an abnormal pressure increase (and hence, the restriction) is found.

3. If the restriction is in the tubing or fitting, remove the restriction by back flushing or by replacing the tubing or fitting (see [Section 5.3](#)).

ICS-1000 Ion Chromatography System

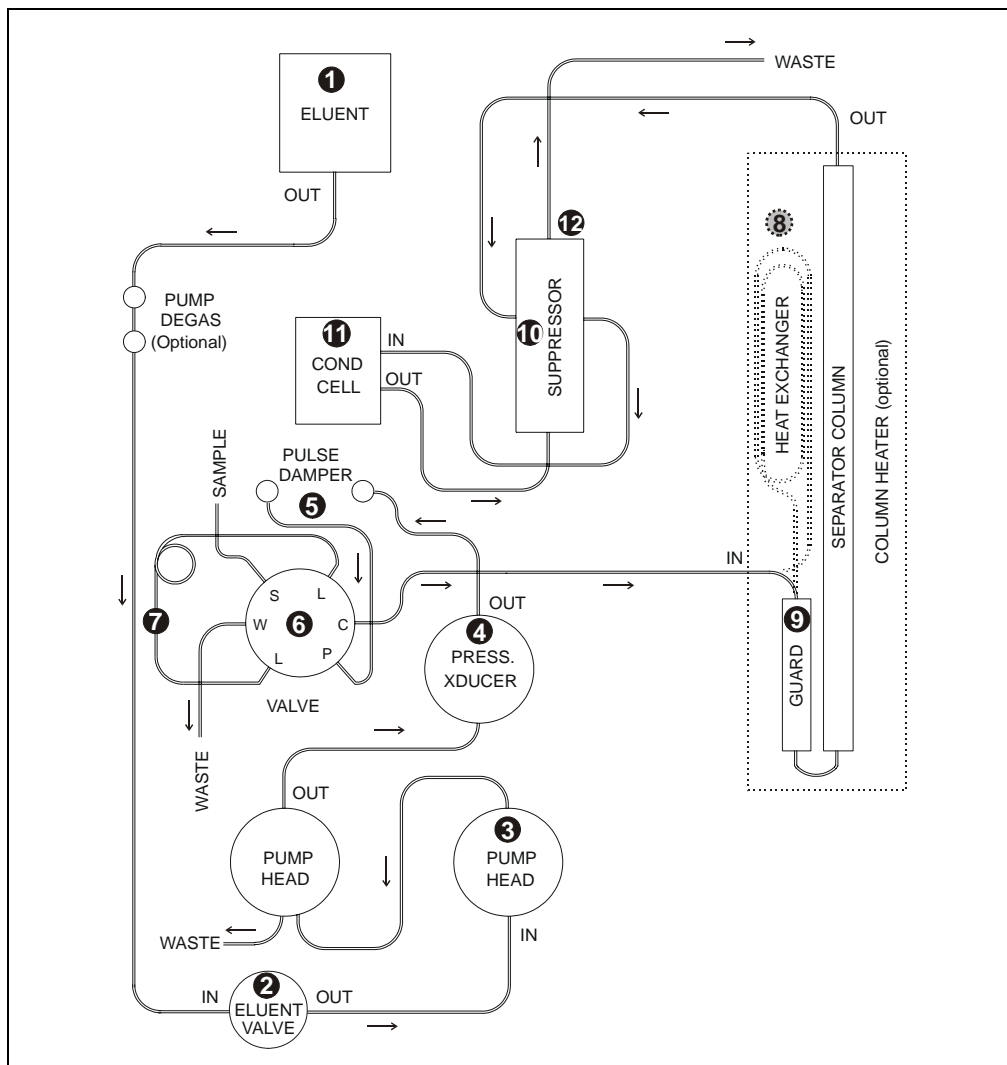

Figure 5-2. ICS-1000 Flow Schematic

NOTE The numbers on the flow schematic indicate the order in which liquid flows through the system components.

5.3 Replacing Tubing and Fittings

The ICS-1000 is plumbed with the tubing and tubing assemblies listed below.

Tubing Size and Type	Color	Used For
0.125-mm (0.005-in) ID PEEK (P/N 044221)	Red	Connection from pump pulse damper to pressure transducer
0.25-mm (0.010-in) ID PEEK (P/N 042690)	Black	Connections between other system components
0.50-mm (0.020-in) ID PEEK (P/N 042855)	Orange	Connection from injection port to injection valve
0.75-mm (0.030-in) ID PEEK (P/N 044777)	Green	Connection from injection valve to waste
1.58-mm (0.062-in) ID Teflon (P/N 014157)	Clear	Connection from pump to degas or eluent reservoir; pump waste
25 μ L sample loop (P/N 042857)	Orange	Connection between ports L (1) and L (4) on the injection valve

- 10-32 fittings (P/N 043275) and ferrules (P/N 043276) are used for most tubing connections. For tightening requirements, refer to *Installation of Dionex Liquid Line Fittings* (Document No. 031432). The manual is on the Dionex Reference Library CD-ROM (P/N 053891).
- 1/8-in fittings (P/N 052267) and ferrules (P/N 048949) are used for connections to the suppressor **REGEN OUT** port and the eluent reservoir.

5.4 Rebuilding the Injection Valve

Dionex recommends rebuilding the injection valve annually. The Injection Valve Rebuild Kit (P/N 057896) contains all required replacement parts.

NOTE Substitution of non-Dionex parts may impair valve performance and void the product warranty.

1. Turn off the pump from the ICS-1000 Control panel in Chromeleon.
2. Open the ICS-1000 front door.
3. Disconnect each liquid line connected to the injection valve.
4. Follow the instructions provided in the Rebuild Kit to replace the rotor seal, isolation seal, and stator face.
5. Reconnect all liquid lines to the injection valve (see [Figure 5-3](#)).
6. Close the door.
7. Turn on the pump.

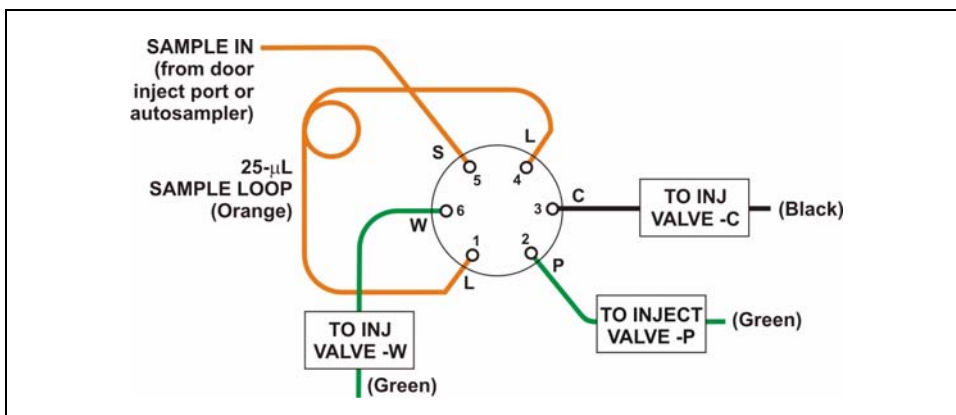

Figure 5-3. Injection Valve Plumbing

5.5 Cleaning and Replacing the Pump Check Valves

A dirty check valve causes erratic flow rates and pressures. In addition, it may cause the pump to lose prime and/or be difficult to reprime. If possible, replace dirty check valves. If new check valves are not available, follow the instructions for cleaning.

Replacing Check Valves

1. Close the eluent valve from the ICS-1000 Control panel in Chromeleon.
2. Turn off the main power switch, to ensure that you do not unintentionally start the ICS-1000.
3. To prevent contamination of pump parts, put on a pair of rubber gloves before disassembling the pump head.
4. Disconnect the tube fittings from the inlet and outlet check valve assemblies on the primary pump head (see [Figure 5-4](#)).
5. Use a 1/2-inch wrench to loosen both check valve assemblies. Remove the check valve assemblies from the pump head.

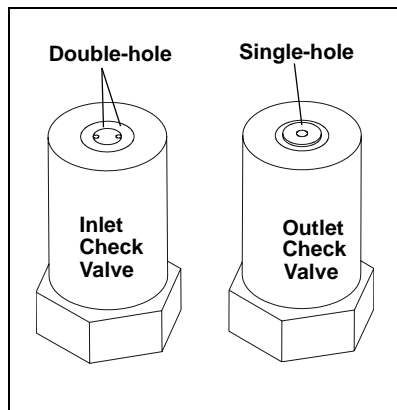

Figure 5-4. Pump Heads

NOTE The *inlet* check valve assembly housing has a 1/4-28 port.
The *outlet* check valve assembly housing has a 10-32 port.

- If you are installing new cartridges (P/N 045994) in the existing check valve housings, place the cartridge in the *inlet* check valve housing with the double-hole end of the cartridge visible and place the cartridge in the *outlet* housing with the single-hole end visible.

NOTE The pump will not operate properly unless the cartridge is installed in the housing in the correct orientation. Liquid flows through the check valve in the large single hole and out the small double holes.



- Install the inlet check valve assembly (P/N 045722) on the bottom of the primary pump head. Install the outlet check valve assembly (P/N 045721) on the top of the head. Tighten the check valves fingertight, and then use a wrench to tighten an additional one-quarter to one-half turn.



Overtightening may damage the pump head and check valve housing and crush the check valve seats.

- Reconnect the liquid lines. Turn on the ICS-1000 main power.
- Open the eluent valve from the ICS-1000 Control panel in Chromeleon.
- Prime the pump (see [Section B.14](#)).
- When the ICS-1000 is at operating pressure, check for leaks from the check valves. Tighten a check valve a *little more* only if it leaks.

Cleaning Check Valves

- Carefully remove the check valve cartridges from the valve housings.
- Place the check valve housings and cartridges in a beaker with methanol. Sonicate or agitate the parts for several minutes.
- Rinse each check valve housing and cartridge thoroughly with filtered deionized water.
- See [Step 6](#) through [Step 11](#) above to reinstall the check valves and complete the procedure.

5.6 Replacing a Pump Piston Seal and Piston Rinse Seal

A damaged seal allows leakage past the piston, as well as leakage from the piston seal wash housing. The pump may be difficult to prime, flow rates may be unstable, and there may be baseline noise.

Preparation

1. Rinse the pump flow path with deionized water. Direct the flow to waste by opening the waste valve on the secondary pump head (see [Figure 5-7](#)). To open the valve, turn the knob one-quarter to one-half turn counterclockwise.
2. After rinsing, close the waste valve.
3. Close the eluent valve from the ICS-1000 Control panel in Chromeleon.
4. To prevent contamination of pump parts, put on a pair of rubber gloves before disassembling the pump head.

Removing the Head and Piston

1. Turn off the main power switch, to ensure that you do not unintentionally start the ICS-1000.
2. Disconnect all tubing connections to the pump head.
3. Locate the open-end wrench (P/N 014605) provided in the ICS-1000 Ship Kit (P/N 057905). Use the wrench to remove the two acorn nuts (see [Figure 5-4](#)) from the pump head.
4. Slowly pull the head and allow it to separate from the housing. Carefully disengage the head from the piston by pulling the head straight off and away from its mounting studs.



Lateral motion while disengaging the pump head from the piston may break the piston.



Un mouvement latéral pendant la séparation de la tête et du piston peut casser le piston.



Vermeiden Sie Seitwärtsbewegungen, wenn Sie den Kopf vom Kolben lösen. Andernfalls kann der Kolben brechen.

ICS-1000 Ion Chromatography System

5. Place the head (front end down) on a clean work surface and lift off the spacer to expose the piston seal (see [Figure 5-5](#) or [Figure 5-6](#)).

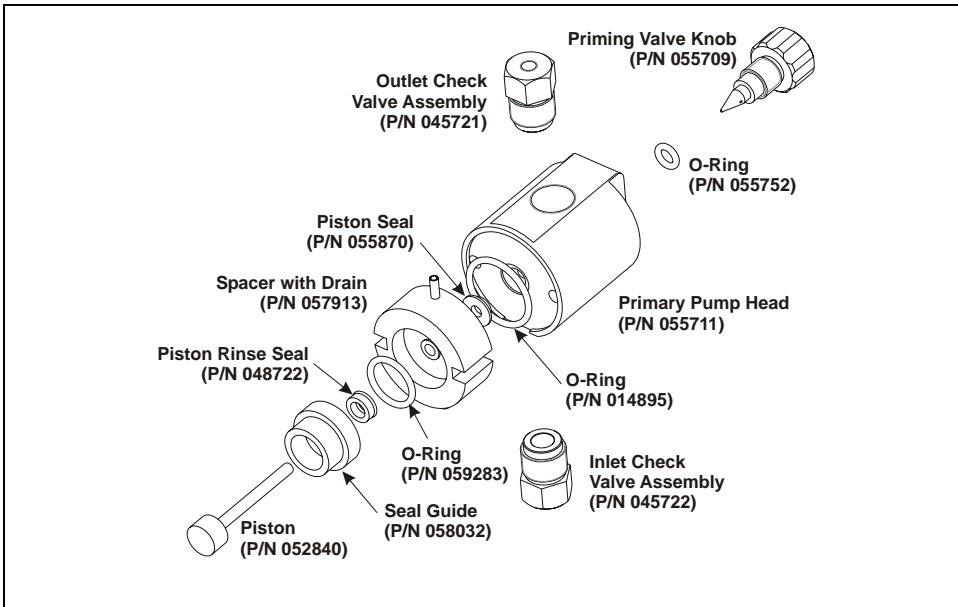

Figure 5-5. Primary Pump Head

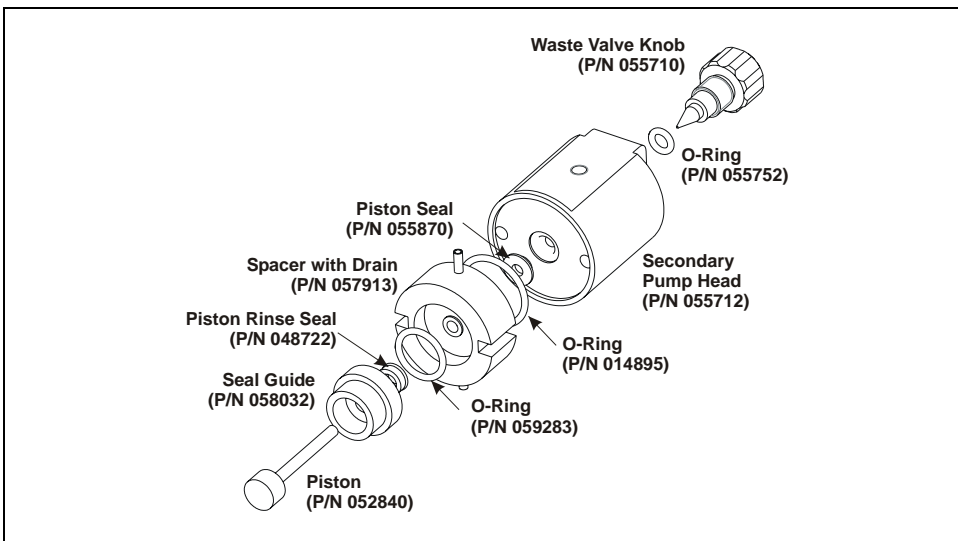
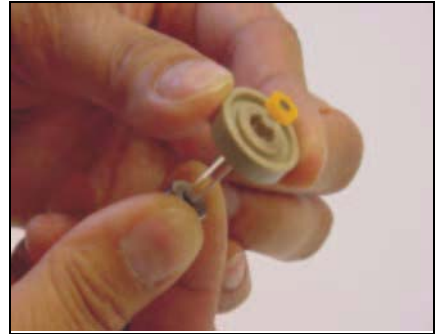

Figure 5-6. Secondary Pump Head

- The piston does not come off as part of the pump head assembly because it is captured by a magnetic retention system. After removing the pump head, hold the shaft of the piston (near the base), tilt the piston slightly, and pull the piston away from the pump.

Installing the New Piston Rinse Seal

- Remove the guide from the spacer to expose the piston rinse seal and O-ring. Remove the O-ring.
- Remove the old piston rinse seal from the guide as follows:
 - Hold the guide with the flat side facing up.
 - To dislodge the piston rinse seal, gently insert the shaft of the piston through the small hole in the center of the guide (see photo).
 - Pull the seal off the end of the piston shaft and remove the piston from the guide.
- Hold the new piston rinse seal (P/N 048722) with the grooved side facing up.
- Using your fingertip, gently press the piston rinse seal into the guide until the edge of the seal is below the surface of the guide.

**IMPORTANT**

The piston rinse seal is made of soft plastic. Do not press on the seal with anything hard or sharp, including your fingernail. If the seal is nicked or gouged, it will not seal properly and may result in leaks.

- Place the new O-ring (P/N 059283) into the groove in the guide.
- Remove the O-ring from the groove in the flat side of the spacer and replace it with the new O-ring (P/N 014895).
- In one hand, hold the guide with the O-ring and piston rinse seal facing up (this prevents the O-ring from falling out). In the other hand, hold the spacer with the cavity facing down.
- Gently press the guide into the cavity in the spacer until it is fully seated.

Removing the Piston Seal from the Head

1. Fill the head cavity with deionized water by injecting the liquid through either the piston opening or the inlet check valve.
2. Reinsert the piston approximately 3 mm (0.125) inch into the seal.
3. If this is the *primary* pump head, install a 10-32 fitting plug (P/N 042772) on the outlet check valve. Tighten the plug.
4. If this is the *secondary* pump head, install a 10-32 fitting plug (P/N 042772) in both the inlet and outlet ports. Tighten the plugs.
5. Push the piston into the head. (This should hydraulically unseat the seal from the head.) Remove the piston and pull off the seal.

NOTE If the piston seal is not removed, make sure the 10-32 fitting plug(s) are tight and add more water. Make sure the head contains no air bubbles, and then repeat Steps 2 and 5.

6. Remove the 10-32 fitting plug(s).

Installing the New Piston Seal

1. Open the priming valve knob (primary pump head) or waste valve knob (secondary pump head) by turning the knob one-quarter to one-half turn counterclockwise.
2. Push the piston through the spacer and then through the new seal. Insert the piston and seal into the pump head until the seal makes contact with the bottom of the counterbore.

NOTE If necessary, lubricate the seal with a small amount of isopropyl alcohol to facilitate insertion.

3. To seat the seal, push down on the spacer until it is flush with the head. A clicking sound indicates that the seal is correctly seated.
4. Close the priming valve knob or waste valve knob.

Reinstalling the Head and Piston

Dionex recommends reinstalling the head and piston as a single assembly, so that the piston centers itself onto the magnetic follower.

1. Hold the assembled spacer and guide with the drain tubes aligned vertically and press the spacer into the head until it is flush with the indented surface of the head.
2. Insert the piston so that 1/4 inch of the shaft is exposed. This ensures that the magnet in the follower picks up the piston. (The follower is the cylinder that holds the piston in place as it moves in and out of the pump head assembly.)
3. Reinstall the head and piston assembly; use a wrench to tighten the nuts evenly (12 in-lb torque).

Completing the Procedure

1. Reconnect all liquid lines to the pump head.
2. Turn on the main power switch.
3. Open the eluent valve.
4. Prime the pump (see [Section B.14](#)).

5.7 Replacing a Pump Piston

Continued leaking of the piston seal after installation of a new seal (assuming the pump head is tight) indicates a dirty, scratched, or broken piston.

Follow the instructions in [Section 5.6](#) to install a new piston (P/N 052840) and piston seal (P/N 055870).

5.8 Replacing the Waste Valve or Priming Valve O-Ring

A damaged O-ring causes leakage around the base of the waste valve or priming valve knob.

1. Close the eluent valve from the Control panel in Chromeleon.
2. Turn off the main power switch, to ensure that you do not unintentionally start the ICS-1000.
3. To remove the waste valve or priming valve from the pump head (see [Figure 5-7](#)), turn the knob counterclockwise until it is loose, and then pull the knob straight out of the cavity in the pump head.



Figure 5-7. Waste and Priming Valves

- If the O-ring is removed with the valve knob in [Step 3](#), pull the O-ring off the end of the knob (see [Figure 5-8](#)). If the O-ring is not removed with the valve knob, insert a thin object (for example, the bent end of a paper clip) into the cavity in the pump head and carefully pull out the O-ring. **Do not scratch the cavity.**

IMPORTANT

Scratches in the cavity will cause leaks around the base of the knob while the pump is being primed.

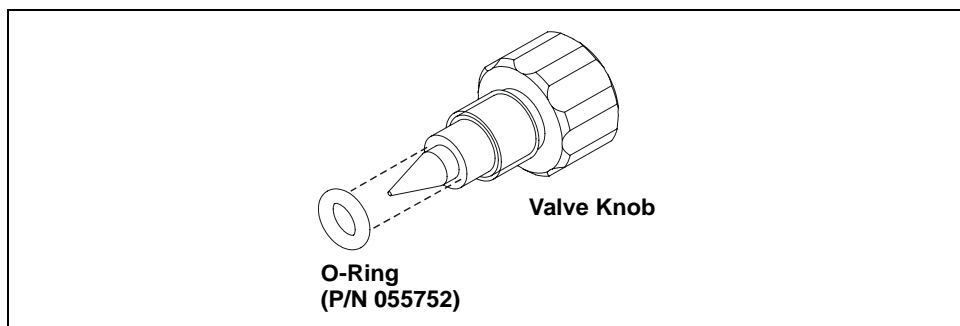

Figure 5-8. Waste Valve or Priming Valve O-Ring Replacement

- Slide a new O-ring (P/N 055752) over the end of the valve.
- To reinstall the valve containing the new O-ring, turn the knob clockwise and then tighten fingertight.

NOTE It is normal to encounter resistance after several rotations of the knob; the O-ring is being pushed into the cavity of the pump head.

- Turn on the main power switch.
- Open the eluent valve.
- Prime the pump (see [Section B.14](#)).

5.9 Replacing the Conductivity Cell

1. Turn off the ICS-1000 power.
2. Open the front door and disconnect the tubing from the **CELL IN** and **CELL OUT** fittings (see [Figure 5-9](#), View A). Loosen the two screws on the cell front cover. The screws remain attached (see [Figure 5-9](#), View B).

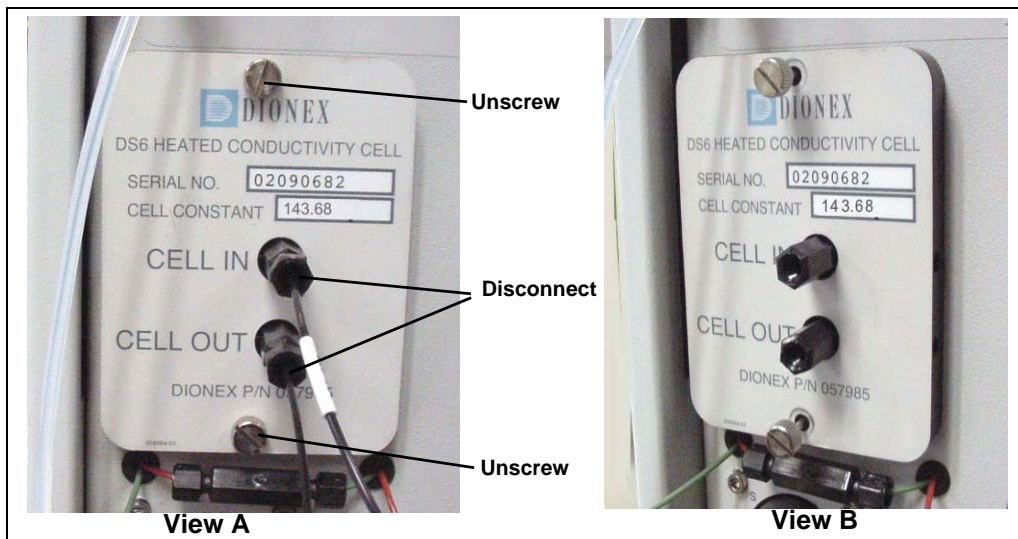

Figure 5-9. Removing the Cell Front Cover

3. Grip the two loosened screws and pull the cell cover toward you to remove it from the component panel. **Do not pull from the CELL IN and CELL OUT fittings.**
4. Continue pulling on the cover until the attached cell assembly slides out the front of the ICS-1000 (see [Figure 5-10](#)).

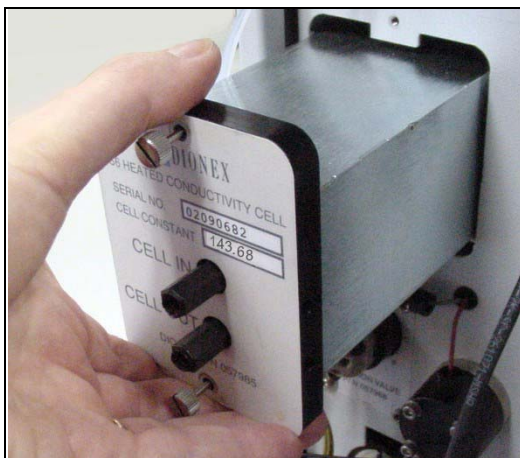

Figure 5-10. Removing the Cell Assembly

5. Slide the new cell assembly into the opening in the component panel until it stops and the cell cover is flush against the component panel. The cell's electronic connector automatically plugs into a connector inside the ICS-1000 when you push the assembly into the opening.
6. Tighten the screws on the cell front cover fingertight.
7. Reconnect the inlet and outlet lines.
8. Turn on the ICS-1000 power.
9. Calibrate the new cell in Chromeleon. Cell calibration of a new cell consists of three parts:
 - Running the offset calibration, which measures the output of the cell electronics alone and determines an offset value to be applied to raw conductivity readings.
 - Running the slope calibration, which measures the output of the cell electronics when a built-in dummy cell, which provides a constant conductivity reading of 21 μS , is automatically enabled. The slope value is applied to raw conductivity readings.
 - Entering the cell constant measured at the factory. The ICS-1000 uses the cell constant to determine the measured conductivity.
 - a. Open the Wellness Panel (see [Section 5.1.1](#))
 - b. Under **Electric Conductivity Cell Calibration**, click **Offset Cal.**
 - c. When the offset calibration is complete, click **Slope Cal.**
 - d. Click **Calibration Details**. Under **Conductivity Cell Cal Details**, enter the **Cell Constant** value printed on the front of the cell.
 - e. In the field next to the **Download** button, verify that **Current** is selected and then click **Download** to download the new value to the ICS-1000.
 - f. To ensure that the new values are recorded in the ICS-1000 memory, do not turn off the ICS-1000 power for at least 1 minute after downloading.

5.10 Replacing the Suppressor

Refer to the suppressor manual for guidance about when to replace a suppressor. Suppressor manuals are included on the Dionex Reference Library CD-ROM (P/N 053891).

1. Refer to the suppressor quick start guide (shipped with the suppressor) for instructions on preparing the suppressor before initial use and for additional installation details.
2. Turn off the pump from the ICS-1000 Control panel in Chromeleon.
3. Open the front door of the ICS-1000.
4. Disconnect the two eluent and the two regenerant lines from the suppressor.
5. To remove the suppressor from the component mounting panel, slide it up to detach it from the mounting tabs on the panel and then pull it toward you.
6. Continue pulling the suppressor out until the yellow connector on the cable inside the ICS-1000 is outside the panel (see [Figure 5-11](#)).
7. Disconnect the suppressor cable (twist the ring on the yellow connector and pull the two connectors apart).

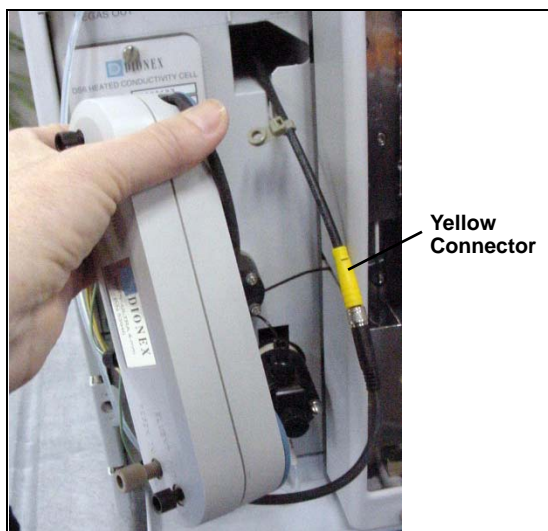

Figure 5-11. Removing the Suppressor

8. Connect the cable from the new suppressor to the ICS-1000 cable (align the pins on the two connectors and push them together).
9. Orient the suppressor with the **REGEN OUT** fitting on top and the cables to the right.
10. Push the cables into the opening in the component panel.

11. Align the top of the suppressor with the guide line printed on the component panel (see [Figure 5-12](#)) and align the slots on the rear of the suppressor with the tabs on the panel.
12. Press the suppressor onto the tabs and then slide it down until it locks into place. Pull slightly on the center of the suppressor to verify that it is securely fastened. **Note:** Some suppressors require more force to secure them onto the tabs.
13. Connect the two eluent and two regenerant lines to the new suppressor.
14. Close the ICS-1000 front door.

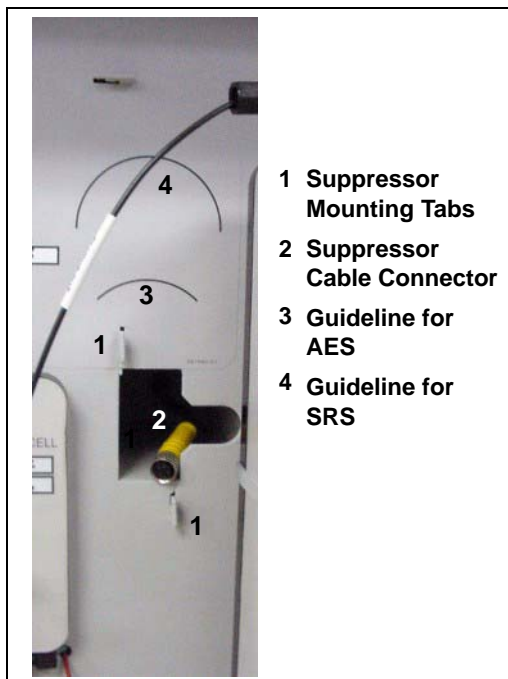

Figure 5-12. Suppressor Guidelines and Mounting Tabs on Component Panel

5.11 Replacing the Column Heater

1. Turn off the ICS-1000 power.
2. Open the front door of the ICS-1000.
3. Follow the steps below to remove the existing column heater:
 - a. Unscrew the two thumbscrews on the heater cover (they remain attached to the cover).
 - b. Pull the heater cover straight out to remove it.

- c. Unscrew the six thumbscrews on the top metal plate (see [Figure 5-13](#)) and remove the plate.

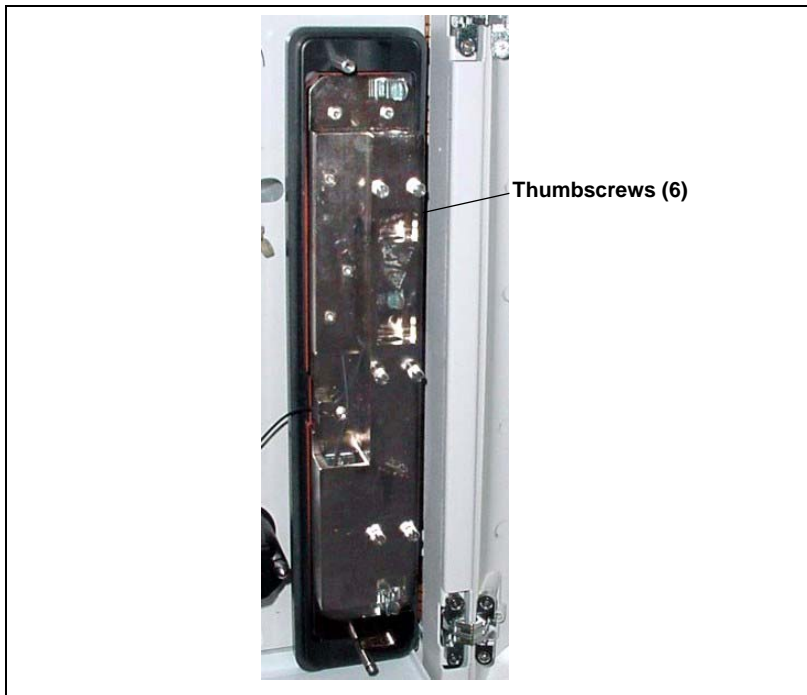

Figure 5-13. ICS-1000 Column Heater Cover Removed

- d. Remove the columns from the column heater.
 - e. Pull the column heater straight toward you to remove it from the component panel.
4. Before installing the new column heater, write down the two calibration values (offset and slope) recorded on the back of the heater.
 5. Align the connector on the back of the new column heater (P/N 058060) with the connector on the component panel (see [Figure 2-4](#)) and push the column heater onto the component panel.
 6. Remove the heater cover and the metal plate on the new heater.
 7. Install the columns in the new heater and replace the top metal plate and heater cover.
 8. Turn on the ICS-1000 power.

9. Enter the column heater calibration values in Chromeleon as follows.
 - a. Open the Wellness Panel (see [Section 5.1.1](#)) and click **Calibration Details**.
 - b. Under **Column Heater Calibration Values**, enter the **Column Heater Offset** and **Column Heater Slope** values recorded in [Step 4](#).
 - c. In the field next to the **Download** button, verify that **Current** is selected and then click **Download** to download the new calibration values to the ICS-1000.
 - d. To ensure the new calibration values are recorded in the ICS-1000 memory, do not turn off the ICS-1000 power for at least 1 minute after downloading the values.

5.12 Replacing the Column Heater Heat Exchanger

1. Turn off the ICS-1000 power.
2. Open the front door of the ICS-1000.
3. Unscrew the two thumbscrews on the column heater cover (they remain attached to the cover).
4. Pull the heater cover straight out to remove it.
5. Unscrew the six thumbscrews on the top metal plate (see [Figure 5-14](#)) and remove the plate.
6. Disconnect the heat exchanger inlet line from Port C on the injection valve.

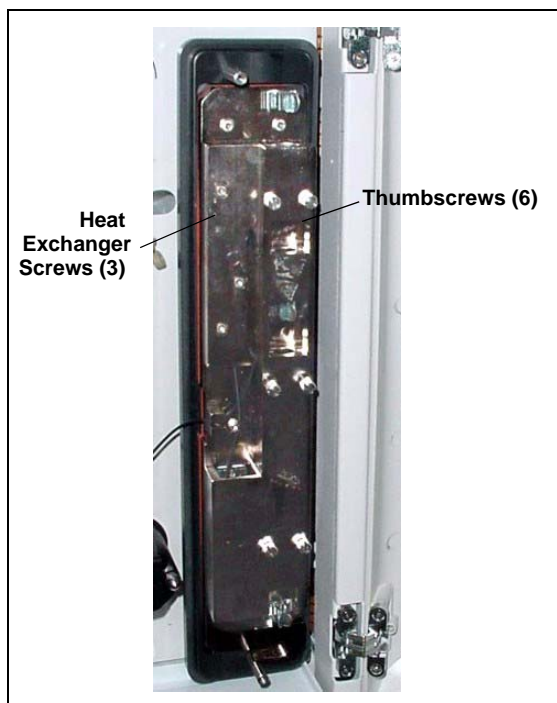

Figure 5-14. ICS-1000 Column Heater Cover Removed

7. Disconnect the heat exchanger outlet line from the guard column inlet.
8. Use an Allen wrench to remove the three screws from the heat exchanger metal plate and remove the plate (with the tubing) from the heater.
9. Remove the plastic backing from the new heat exchanger (P/N 059979, with 0.25-mm (0.010-in) ID tubing; P/N 060943, with 0.125-mm (0.005-in) ID tubing) and press the heat exchanger onto the heater. Replace the screws removed in [Step 8](#).
10. Connect the new heat exchanger inlet line to Port C on the injection valve and connect the outlet line to the guard column inlet.
11. Reinstall the top metal plate and the heater cover.

5.13 Replacing the Eluent Valve

1. Turn off the power to the ICS-1000.
2. Open the ICS-1000 front door.
3. To prevent an eluent leak during the valve replacement procedure, disconnect the eluent line from the reservoir cap. Or, plug the line on the left side of the valve with a union (P/N 039056 and a plug (P/N 037268) after disconnecting the liquid line from the valve ([see Step 4](#)).
4. Disconnect the two liquid lines connected to the eluent valve (see [Figure 5-15](#)).
5. Unscrew and remove the two screws that attach the valve to the component panel (see [Figure 5-15](#)). Save the screws.

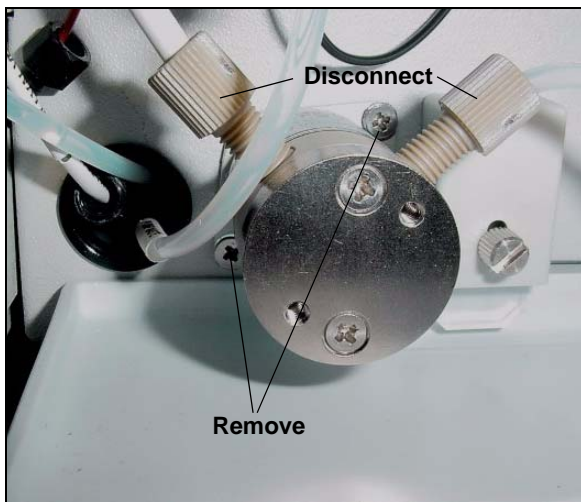

Figure 5-15. Eluent Valve

6. Pull the valve straight out from the component panel and begin pulling the attached cable out of the opening in the panel.
7. The cable is connected to a matching cable inside the ICS-1000. Continue pulling until the connectors for the two cables are outside the panel (see [Figure 5-16](#)). Disconnect the cables.

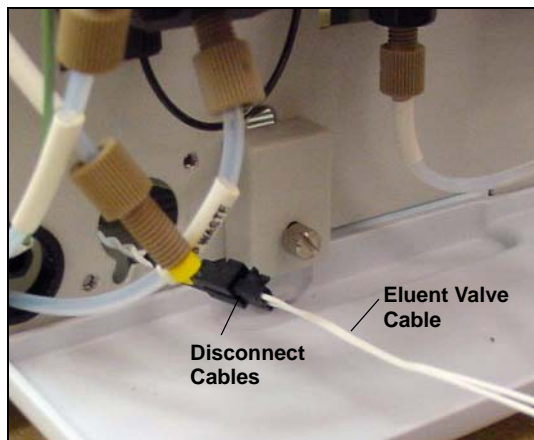

Figure 5-16. Eluent Valve Cable

8. Remove the mounting plate on the old valve by unscrewing and removing the two screws. Save the screws.
9. Thread the cable from the new eluent valve through the mounting plate.
10. Attach the mounting plate to the new valve using the screws removed in [Step 8](#).



Figure 5-17. Removing the Valve Mounting Plate

11. Connect the cable from the new valve (P/N 057945) to the ICS-1000 cable. Feed the cables back inside the ICS-1000.
12. Align the new valve on the component panel with the liquid ports facing up and attach it with the two screws removed in [Step 5](#). Reconnect the liquid lines.
13. Turn on the power to the ICS-1000.
14. Prime the pump (see [Section B.14](#)).

5.14 Replacing the Leak Sensor

1. Turn off the power to the ICS-1000.
2. Open the ICS-1000 front door.
3. Loosen the screw on the front of the leak sensor (see [Figure 5-18](#)). **Note:** The screw remains attached to the sensor.

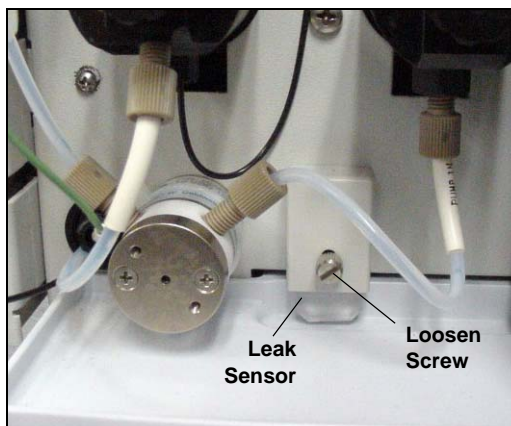

Figure 5-18. Leak Sensor

4. Remove the leak sensor from the component panel and pull the cable out of the opening in the panel.
5. The cable attached to the leak sensor is connected to a matching cable inside the ICS-1000. Continue pulling the cable until the connectors for the two cables are outside of the panel (see [Figure 5-19](#)).
6. Disconnect the two cables.

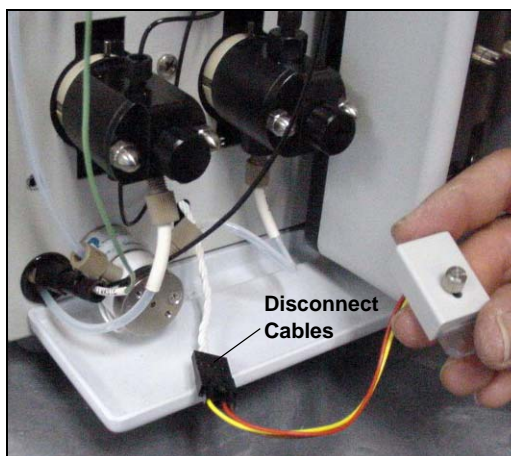

Figure 5-19. Leak Sensor Cable

7. Connect the cable from the new leak sensor (P/N 058053) to the ICS-1000 cable.
8. Feed the cables back inside the ICS-1000. Align the leak sensor with the component panel opening and fingertighten the screw.
9. Make sure the leak sensor does not touch the bottom of the drip tray.

5.15 Priming the Pump with Isopropyl Alcohol

NOTE Prime the pump heads with isopropyl alcohol only if the two standard priming procedures described in [Section B.14](#) are unsuccessful.

1. Connect a 10-mL syringe (P/N 054578) filled with isopropyl alcohol (IPA) to the port in the primary pump head (see [Figure 5-20](#)).
2. Open the waste valve on the secondary pump head (see [Figure 5-20](#)) by turning the knob one-quarter to one-half turn counterclockwise.

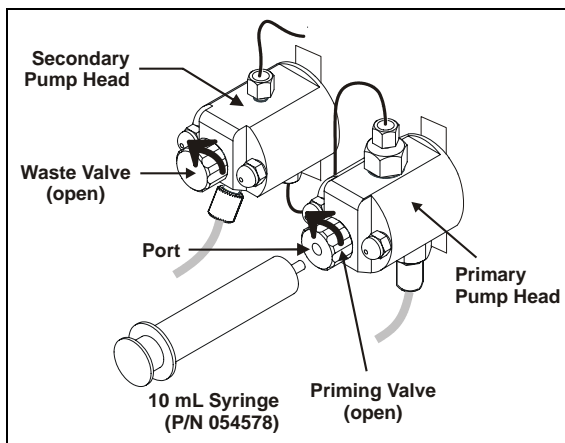

Figure 5-20. Priming the Pump Heads with IPA

3. Click **Pump On** on the Chromeleon Control panel to turn on the pump motor.
4. Open the priming valve on the primary pump head by turning it one-quarter to one-half turn counterclockwise.
5. Use the syringe to slowly push alcohol through the pump.

NOTE Be careful not to push any air trapped in the syringe through the pump. Check the waste line from the secondary pump head to verify that there are no air bubbles.

6. Close the priming valve. **Do not overtighten.** Disconnect the syringe from the priming valve.
7. Let the pump run for several minutes, to purge alcohol from the pump heads, and then click **Prime** and flush the heads with the desired eluent.



Isopropyl alcohol may damage some columns. Be sure to thoroughly rinse the alcohol from the pump, using the process described in [Step 7](#).

8. Close the waste valve. **Do not overtighten.**
9. Select the flow rate required for the analysis.
10. Click **Pump Off** to turn off the pump motor. The pump is now ready for operation.

5.16 Changing Main Power Fuses

1. Turn off the main power switch.



HIGH VOLTAGE—Disconnect the main power cord from its source and also from the rear panel of the ICS-1000.



HAUTE TENSION—Débranchez le cordon d'alimentation principal de sa source et du panneau arrière du ICS-1000.



HOCHSPANNUNG—Ziehen Sie das Netzkabel aus der Steckdose und der Netzbuchse auf der Rückseite des ICS-1000.

2. The fuse holder is part of the main power receptacle (see [Figure 5-21](#)) on the ICS-1000 rear panel. To remove the fuse holder, squeeze the tab on the top of the holder to release it and pull the holder straight out of its compartment.

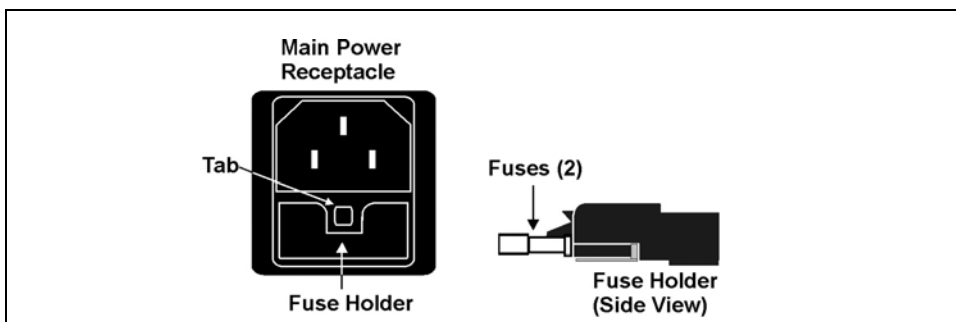

Figure 5-21. Main Power Fuse Holder

3. Replace the two fuses in the holder with new IEC 127 fast-blow fuses rated 3.15 amps (P/N 954745). Dionex recommends always replacing both fuses.
4. Reinsert the fuse holder into its compartment and push in until the tab clicks in place.
5. Reconnect the main power cord and turn on the power.

A • Specifications

A.1 Electrical

Main Power 85 to 265 Vac, 47 to 63 Hz. The ICS-1000 power supply is auto-sensing and requires no voltage adjustment

Fuses Two 3.15 amp fast-blow IEC 127 fuses (P/N 954745)

A.2 Physical

**Dimensions
(without
reservoir)** Height: 56.1 cm (22.1 in)
Width: 22.4 cm (8.8 in)
Depth: 53.3 cm (21.0 in)

Weight 30 kg (66 lb)

Decibel Level < 52 dbA

A.3 Environmental

**Operating
Temperature** 4 to 40 °C (40 to 104 °F)

Humidity 5 to 95% relative humidity, noncondensing

**Operating
Pressure** 35 MPa (5000 psi) maximum liquid path (tubing, valve, columns, etc.)

A.4 Front Panel

Power LED	On when power is present; off when no power is present
Inject Valve LEDs	Indicate the position of the inject valve.
Alarm LED	Indicates an alarm state.
Status LEDs	Indicate instrument status.

A.5 Pump

Type	Dual-piston (in series), variable speed, 100 μ L per revolution
Flow Rate	Settable range: 0.00 to 5.00 mL/min, in 0.01 increments Optimal Operational Range: 0.40 to 2.0 mL/min
Flow Accuracy	<1% of set value within the optimal operational range
Flow Precision	<0.2%
Operating Pressure	35 MPa (5000 psi), maximum
High Pressure Limit	0.7 to 34.4 MPa (100 to 5000 psi)
Low Pressure Limit	0.0 to 33.7 MPa (0 to 4900 psi)
Delay Volume	<800 μ L
Pressure Ripple	<1% at 13.8 MPa (2000 psi) and 1.0 mL/min

A.6 Detector

Range	0 to 15000 μ S (digital output)
Temperature Compensation	1.7% per $^{\circ}$ C
Cell Drive	8 kHz square wave
Linearity	Correlation >0.999 %RSD <5% to 800 μ S

A.7 Conductivity Cell with Heat Exchanger

Cell Body	PEEK
Electrodes	Passivated 316 stainless steel
Active Volume	1.0 μ L
Operating Temperature	30 to 55 $^{\circ}$ C (86 to 130 $^{\circ}$ F); must be at least 7 $^{\circ}$ C above the ambient temperature
Maximum Pressure	2 MPa (300 psi)

A.8 Injection Valve

Injection Valve	Two-position, six-port, electrically-activated valve with PEEK wetted components
------------------------	--

A.9 Vacuum Degas Assembly (Optional)

Channel	Single-channel degas channel with degas membranes
Pump	Dual-stage diaphragm vacuum pump
Materials	Wetted materials, PEEK, PTFE

A.10 Column Heater (Optional)

Operating Temperature 30 to 60 °C (86 to 140 °F); must be at least 5 °C above the ambient temperature

B • Installation

This chapter provides instructions for the initial installation of the ICS-1000 Ion Chromatography System.

NOTE These installation instructions are also shipped with the ICS-1000 as a stand-alone printed manual (Document No. 031915).

NOTE The order of the steps is important. It is especially important to install Chromeleon before connecting the USB cable and turning on the ICS-1000 power.

B.1 Facility Requirements

- Make sure the ICS-1000 installation site meets the power and environmental specifications listed in Appendix A.
- Provide a sturdy workbench for the ICS-1000 of a height that ensures convenient access to the interior of the ICS-1000.
- Allow at least 15 cm (6 in) behind the ICS-1000 for power connections and ventilation. For optimal performance, install the ICS-1000 in a draft-free location, out of the path of air conditioning and heating vents.
- (Optional) Provide a clean gas source regulated to between 0.55 and 0.83 MPa (80 and 120 psi) for pressurization of the eluent reservoir.
- Use ASTM filtered, Type I (18-megohm) deionized water when preparing eluent and regenerant.

B.2 Unpacking the ICS-1000 System

1. After removing the ICS-1000 from the shipping box and removing the top layer of foam, remove the next layer of foam (see [Figure B-1](#)).

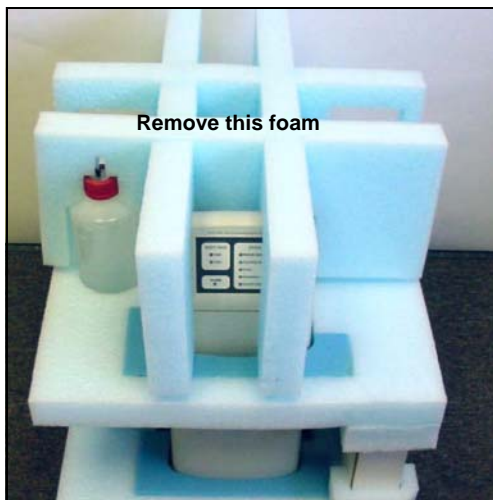

Figure B-1. ICS-1000 After Removing Shipping Box and First Layer of Foam

2. Set the eluent bottle on top of the ICS-1000 (see [Figure B-2](#)).



Figure B-2. ICS-1000 with Eluent Bottle

3. Remove the next layer of foam and remove the Ship Kit box (see [Figure B-3](#)).

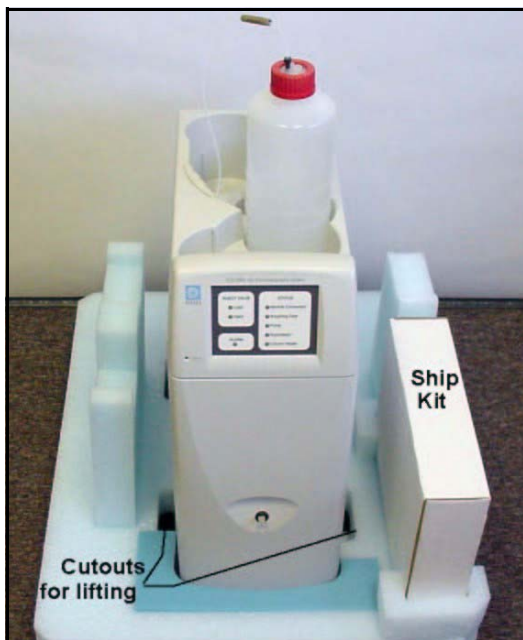

Figure B-3. ICS-1000 with Ship Kit

4. The bottom foam layer has two cutouts on either side of the ICS-1000 module; use these as handholds when lifting the module (see [Figure B-3](#)).
5. Lift the ICS-1000 out of the bottom layer of foam and set it on a workbench. Inspect the ICS-1000 for any shipping damage.



Two or more persons should lift the ICS-1000, which weighs 30 kg (66 lb). Lift the ICS-1000 only from each side of the cabinet bottom. Lifting from the front door will damage the door hinges.



Au moins deux personnes peuvent soulever le ICS-1000: il pèse 30 kg (66 lb). Ne soulevez le ICS-1000 que par chaque côté du fond de l'armoire. Son soulèvement par la porte du panneau avant endommagera les charnières de la porte.



Der ICS-1000 wiegt über 20 kg. Daher sollte das Gerät nur von zwei oder mehr Personen angehoben werden. Greifen Sie dazu an beiden Seiten unter das Gerät. Heben Sie den Autosampller nicht an der Vordertür an, da dadurch die Türangeln beschädigt werden könnten.

B.2.1 Unpacking the Computer (North America only)

NOTE These instructions assume that Chromeleon software was installed on the computer before shipping.

1. Remove the central processing unit (CPU), keyboard, mouse, and all documentation from the computer box and place these items on a workbench.
2. Remove the monitor from its box and place it on the workbench.
3. Follow the instructions in the computer installation guide to hook up the monitor, mouse, keyboard, and CPU.
4. Go on to [Section B.4](#), “Installing the Chromeleon Software License.”

B.2.2 Unpacking the Computer (outside North America)

1. Refer to *Installing the Chromeleon IC System* (Document No. 031883) to verify that the computer being used meets Chromeleon specifications. The manual is on the Dionex Reference Library CD-ROM (P/N 053891).
2. Remove the central processing unit (CPU), keyboard, mouse, and all documentation from the computer box and place these items on a workbench.
3. Remove the monitor from its box and place it on the workbench.
4. Follow the instructions in the computer installation guide to hook up the monitor, mouse, keyboard, and CPU.
5. If Chromeleon is not installed on the computer, go on to [Section B.3](#), “Installing Chromeleon.”
6. If Chromeleon is already installed on the computer, go on to [Section B.4](#), “Installing the Chromeleon Software License.”

B.3 Installing Chromeleon

NOTES

- **Windows® 2000 or Windows XP is required for controlling the ICS-1000 with Chromeleon. Chromeleon version 6.5 SP2 or later is required.**
 - **To install Chromeleon, you must log onto Windows 2000 or XP with administrator privileges. Administrator privileges are not required to run Chromeleon.**
1. Turn on the computer power.
 2. Follow the Windows setup steps as they appear on the screen.
 3. Verify that the monitor display is set to a minimum of 1024 x 768 with 16 bit color.
 4. Insert the Chromeleon CD-ROM into the CD-ROM drive.
 5. The Chromeleon Setup menu appears.
 6. If the Setup menu does not appear automatically, go to the Autorun folder on the Chromeleon CD-ROM and double-click **autorun.exe**.
 7. Select **Launch Chromeleon Setup**.
 8. Setup now guides you through the installation procedure; follow the on-screen instructions as they appear.
 9. When prompted, select whether to add the Chromeleon Server Monitor to the Startup group. If you select yes, the Server Monitor starts automatically when the computer is started, and the program icon appears in the taskbar.
 10. When complete, go on to [Section B.4](#), “Installing the Chromeleon Software License.”

IMPORTANT

Installing DX-LAN Devices

If you will also be installing a module that requires a DX-LAN interface connection, verify that the following steps are completed before continuing:

1. If it is not already installed, install the DX-LAN card in the module. Refer to the operator's manual for the module for installation instructions.
2. Install the DX-LAN card in the computer.
3. Connect the module to the DX-LAN.
4. Install the DX-LAN card driver.

Instructions for Steps 2 through 4 are in *Installing the Chromeleon Chromatography Management System with a Dionex Ion Chromatograph (IC)* (Document No. 031883).

B.4 Installing the Chromeleon Software License

For the Chromeleon computer to control the ICS-1000, a valid software license must be installed. To install the license, you first install a dongle on the computer and then enter a license "Key Code" in Chromeleon. (A dongle is an adapter that is connected to the parallel PC interface or USB port. The dongle stores the serial number of a Chromeleon computer.)

NOTE If the software license is managed via a License Server, a dongle is not required.

1. Plug the dongle into the appropriate port on the computer (either the parallel or USB port, depending on the type of dongle). Tighten the connector screws on a parallel port dongle.
2. If it is not already running, start the Chromeleon Server Monitor (select **Start>Programs>Chromeleon>Server Monitor**). The Server Monitor window opens.

3. Check the server status:
 - If “Chromeleon Server is running idle” is displayed, the license Key Code was entered before shipping the computer, and you can omit the remaining steps in this section. Click **Close** and go on to [Section B.5](#).
 - If “Chromeleon Server is running idle (Evaluation Mode)” is displayed (see [Figure B-4](#)), the license Key Code has not yet been entered. If this is the case, go on to [Step 4](#).

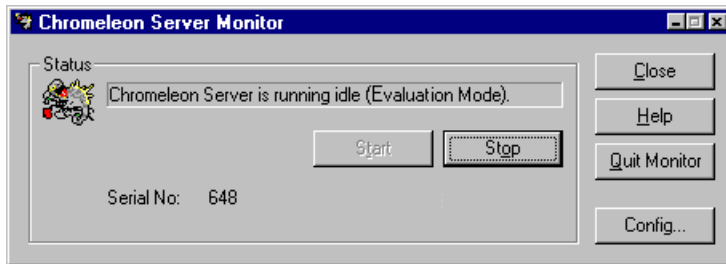

Figure B-4. Server Evaluation Mode

4. Open Chromeleon (select **Start>Programs>Chromeleon>Chromeleon**).

5. Select **File>Preferences** to open the Preferences dialog box (see [Figure B-5](#)). Select the **License** tab and click **Dongle**. Enter the **Key Code** exactly as it appears on the Chromeleon Software License key code sheet. Click **OK**.

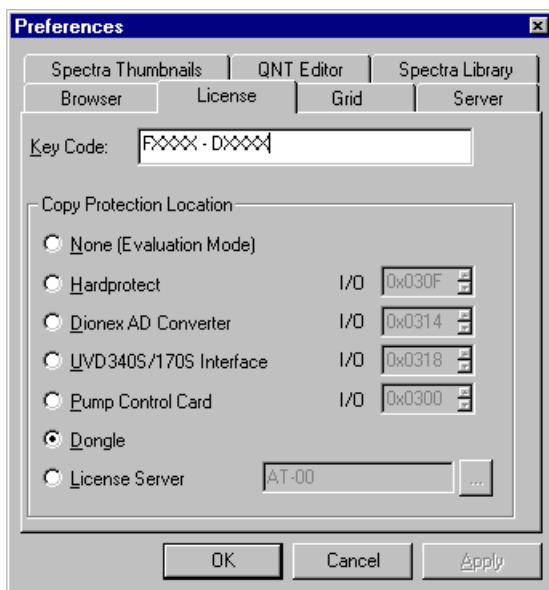

Figure B-5. Preferences: License Page

6. Check the Server Monitor status. It should now display “Chromeleon Server is running idle.” (see [Figure B-6](#)).

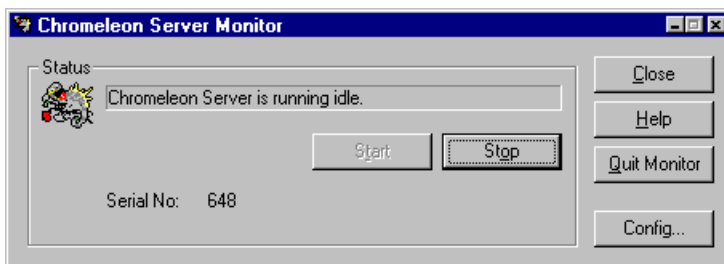

Figure B-6. Server Running

7. Click **Close** to close the Server Monitor window.
8. Go on to [Section B.5](#).

B.5 Connecting the ICS-1000 to the Chromeleon PC

The ICS-1000 rear panel provides a USB receptacle for connecting the ICS-1000 to a USB port on the Chromeleon PC. The rear panel also provides two USB ports for connecting other Dionex USB-compliant modules to the system.

IMPORTANT

Do not turn on the power to the ICS-1000 or other USB module(s) until after you connect the USB cable.

Before connecting the USB cable, verify that Chromeleon is installed. If not, Windows will be unable to identify the new USB device when the power is turned on. See [Section B.3](#) to install Chromeleon.

B.5.1 Connecting the ICS-1000 to the PC

1. Locate the USB cable (P/N 960779) in the ICS-1000 Ship Kit (P/N 057905).
2. Plug the cable's "A" connector into a USB port on the Chromeleon PC and plug the cable's "B" connector into the USB receptacle (labeled **FROM PC**) on the ICS-1000 rear panel (see [Figure B-7](#)).

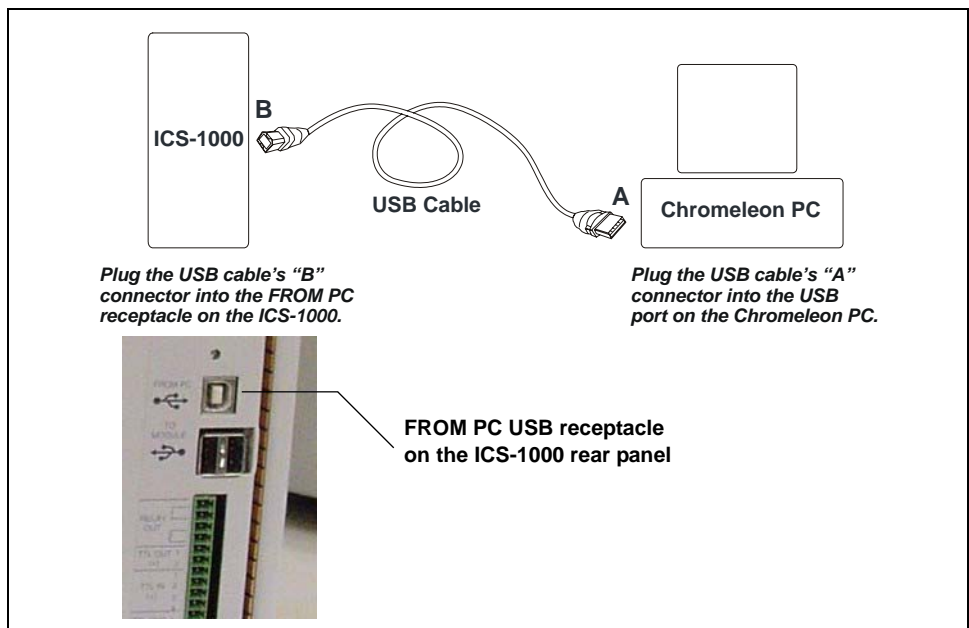

Figure B-7. Example Connections: One ICS-1000 Connected to the Computer

B.5.2 Connecting Additional USB Devices

The ICS-1000 provides two USB ports for connecting additional Dionex USB-compliant modules to the system.

To connect an additional USB module, plug the “A” connector on a USB cable into an “A” port (labeled **TO MODULE**) on the ICS-1000 rear panel and plug the cable’s “B” connector into the USB receptacle on the USB module (see [Figure B-8](#)).

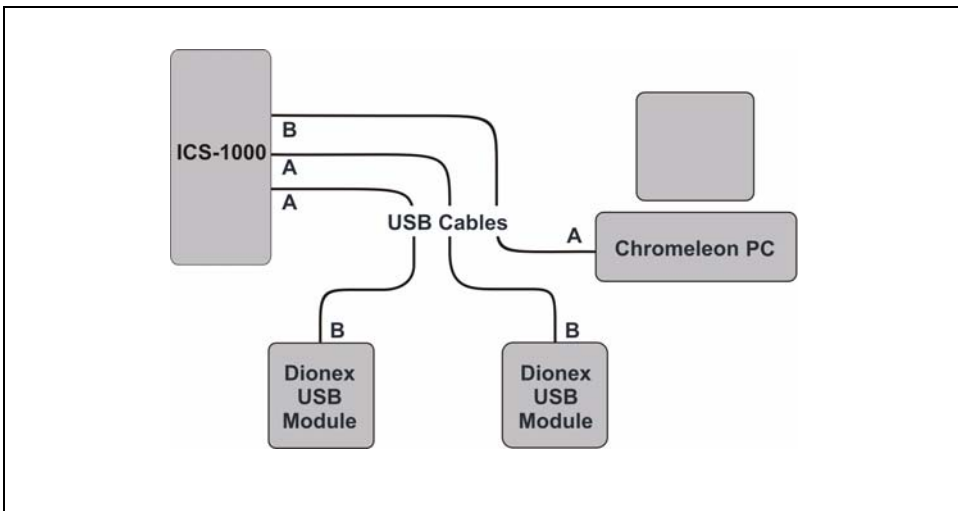

Figure B-8. Example Connections: Two Dionex USB Modules Connected to the ICS-1000

NOTE If the number of USB devices in the system exceeds the number of available USB ports, connect the devices to the system with a USB-compliant, full-speed external hub. One or more hubs is also required if the ICS-1000 or other USB device is more than 5 meters (16 ft) from the PC. Refer to the manual provided by the hub vendor for complete installation instructions.

IMPORTANT

The USB standard limits the USB cable length to 5 meters (16 ft). Each USB device can be separated from the PC by no more than five hubs. Thus, each USB device can be located no more than 30 meters (32 yds) from the PC.

B.6 Connecting the Power Cord

Connect the power cord (IEC 320 C13) (ordered separately) from the main power receptacle on the rear panel to a grounded power source. The ICS-1000 power supply is auto-sensing, so no adjustment is required to select the line voltage.



SHOCK HAZARD—To avoid electrical shock, use a grounded receptacle. Do not operate the ICS-1000 or connect it to AC power mains without an earthed ground connection.



The power supply cord is used as the main disconnect device. Make sure the socket-outlet is located near the ICS-1000 and is easily accessible.



Operation at AC input levels outside of the specified operating voltage range may damage the ICS-1000.



DANGER D'ÉLECTROCUTION—Pour éviter toute électrocution, il faut utiliser une prise de courant avec prise de terre. Ne l'utilisez pas et ne le branchez pas au secteur C.A. sans utiliser de branchement mis à la terre.



Le cordon d'alimentation principal est utilisé comme dispositif principal de débranchement. Veillez à ce que la prise de base soit située/installée près du module et facilement accessible.



STROMSCHLAGGEFAHR—Zur Vermeidung von elektrischen Schlägen ist eine geerdete Steckdose zu verwenden. Das Gerät darf nicht ohne Erdung betrieben bzw. an Wechselstrom angeschlossen werden.



Das Netzkabel ist das wichtigste Mittel zur Stromunterbrechung. Stellen Sie sicher, daß sich die Steckdose nahe am Gerät befindet und leicht zugänglich ist.

B.7 Turning On the ICS-1000 Power

IMPORTANT

Before turning on the ICS-1000 power, verify that Chromeleon software is installed. See [Section B.3](#) for installation instructions. If Chromeleon is not installed first, Windows will be unable to identify the new USB device.



1. If it is not already on, turn on the computer power and log onto Windows 2000 or Windows XP as an administrator.
2. If the Chromeleon Server is not running (the icon on the taskbar is crossed out in red ) , start the Server by right-clicking the icon and selecting **Start Server**. When the server starts, the icon changes to gray  .
3. Press the power switch on the ICS-1000 rear panel (see [Figure B-9](#)) to turn on the power.



Figure B-9. ICS-1000 Rear Panel

4. Windows automatically detects the new USB device. A message flashes on the screen to inform you that new hardware was found.

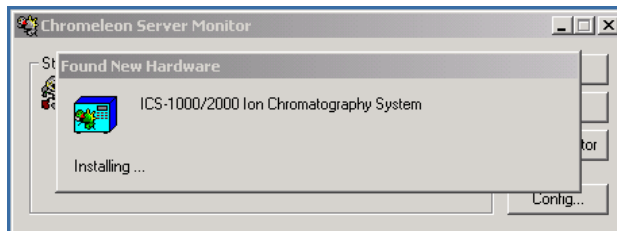

- The Found New Hardware Wizard appears. This wizard installs the ICS-1000 device into the Windows Device Manager. Complete the wizard by selecting the following options:
 - If asked whether Windows can connect to Windows Update to search for software, select **No, not this time**.
 - It is not necessary to insert a hardware installation CD or floppy disk. When asked, simply select the **Install the software automatically (Recommended)** option (see [Figure B-10](#)).

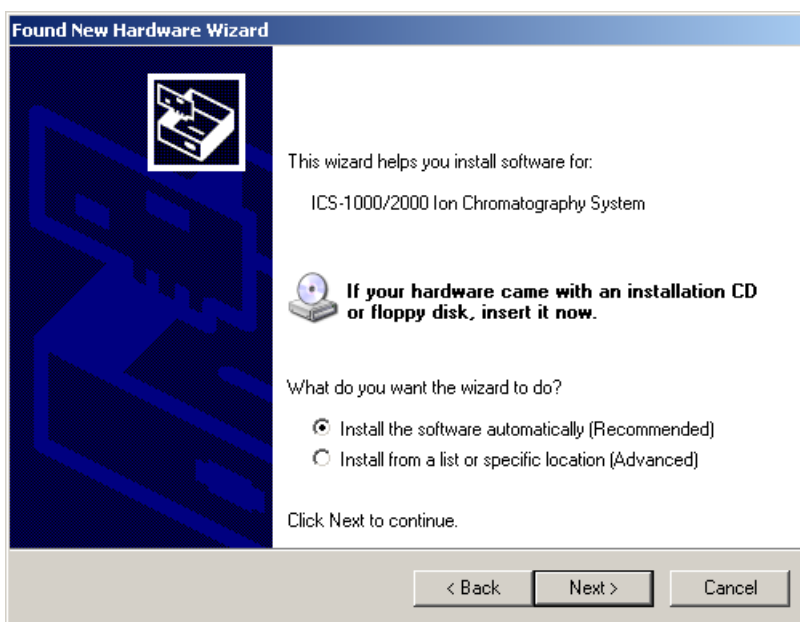

Figure B-10. Windows Found New Hardware Wizard

- After you click **Next**, Windows installs the software.
 - When the wizard finishes installing the software, click **Finish**.
- Go on to [Section B.8](#).

B.8 Setting Up Chromeleon

NOTE This section provides brief instructions for setting up Chromeleon. For details about any of these steps, refer to the Chromeleon user's guide or online Help.

B.8.1 Assigning the ICS-1000 to a Timebase

After the ICS-1000 power is turned on and the Windows Found New Hardware Wizard is finished, the Chromeleon USB Auto Configuration Wizard automatically appears. The wizard presents two options (see [Figure B-11](#)):

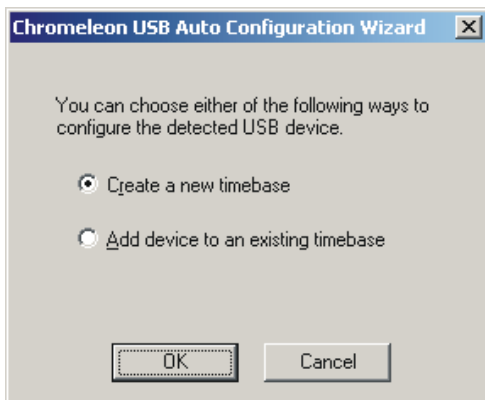

Figure B-11. Chromeleon USB Auto Configuration Wizard: Page 1

To create a new timebase:

1. Select the **Create a new timebase** option and click **OK**.

Page 2 of the wizard appears (see [Figure B-12](#)).

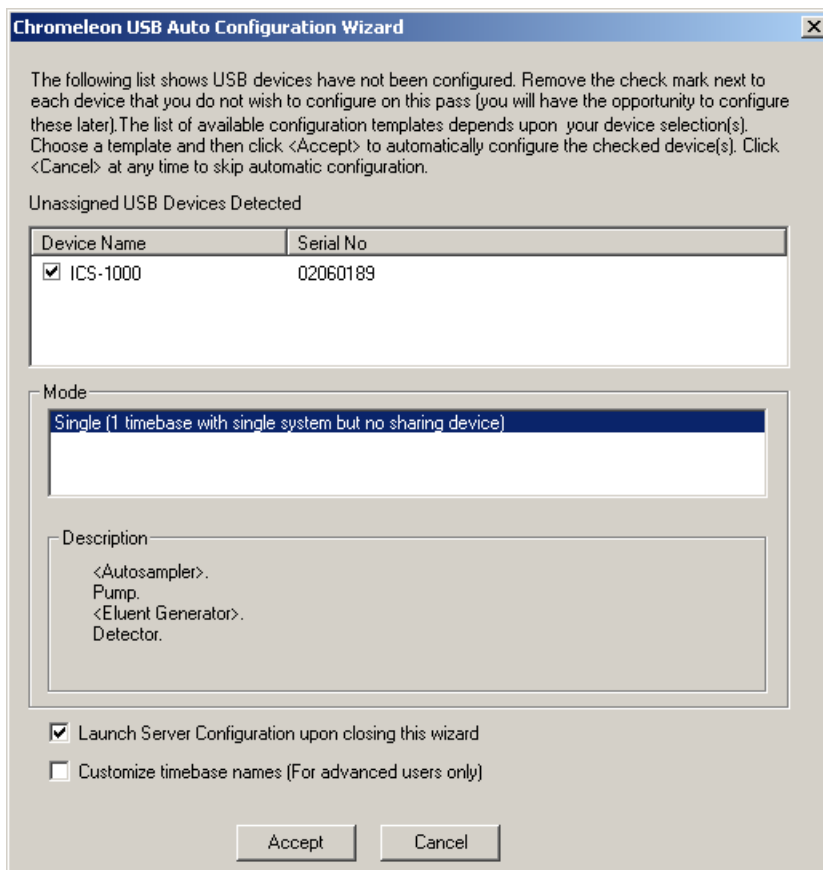

Figure B-12. Chromeleon USB Auto Configuration Wizard: Page 2

2. Review the names displayed in the **Unassigned USB Devices Detected** window. If the list includes the name of a device that you do not want to configure now, clear the check mark before the device name.

If you are installing more than one ICS-1000, you can verify the serial numbers for each by checking the label on the component panel.

3. In the **Mode** window, select a pre-defined configuration template for the new timebase. Typically for the ICS-1000, one configuration is available: **Single (1 timebase with single system but no sharing device)**. The **Description** box lists the devices included in the mode. Devices in brackets are optional.
4. Select the **Launch Server Configuration upon closing this wizard** check box.

The check box is disabled if the Server Configuration program is already running.

5. Click **Accept** to create a new timebase.

The Server Configuration automatically starts running when you close the wizard. If the Server Configuration was already running, it is updated with the new configuration information.

To add an unassigned USB device to an existing timebase:

1. In the Chromeleon USB Auto Configuration Wizard, select the **Add device to an existing timebase** option and click **OK**.

This launches the Server Configuration program.

2. Select an existing timebase to which the ICS-1000 can be assigned.
3. When you finish making changes here, click **OK** to close the dialog box.

The Server Configuration program window appears.

To verify the configuration:

1. In the Server Configuration program, click the + icon next to the server name to expand the folder. The timebase you created is displayed (see [Figure B-13](#)).

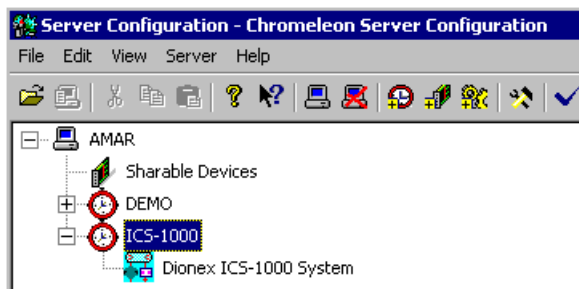

Figure B-13. Server Configuration with ICS-1000 Timebase

2. To verify that the ICS-1000 is correctly connected to the timebase, double-click its name under the timebase. Click **Yes** if the following message appears: “Communication to the device will be stopped...Do you want to continue?”

3. The ICS-1000 System dialog box opens (see [Figure B-14](#)). The **General** page shows the Device Name (**Pump_ECD**), the Mode (**Live**), and the Module Serial No.

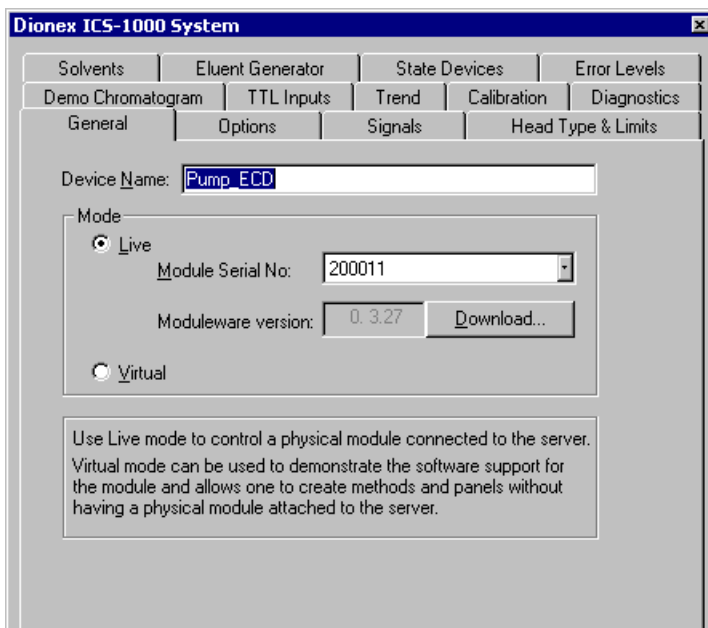



Figure B-14. ICS-1000 System Properties

4. Close the dialog box and then save the configuration (select **File>Save Installation**).
5. If you are going to add one or more DX-LAN devices to the timebase, go on to [Section B.8.2](#). Otherwise, exit the Server Configuration program and then go on to [Section B.9](#).

B.8.2 Assigning DX-LAN Devices to the Timebase (Optional)

Follow the instructions in this section if you are adding one or more devices to the timebase that are connected to the PC through a DX-LAN interface (not through USB connections).

1. Follow the instructions in *Installing the Chromeleon Chromatography Management System with a Dionex Ion Chromatography (IC)* (Document No. 031883) to add the DX-LAN card to the server configuration as a sharable device.
2. Select the timebase that was created for the ICS-1000 (see [Figure B-15](#)); then, click the **Add device** icon  on the toolbar (or select **Edit>Add Device**).

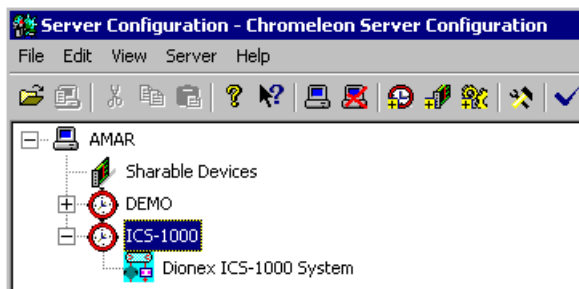

Figure B-15. Example: ICS-1000 Timebase

The Add device to timebase dialog box appears.

- Under **Manufacturers**, select **Dionex: IC Modules** and then select the device from the **Devices** list.

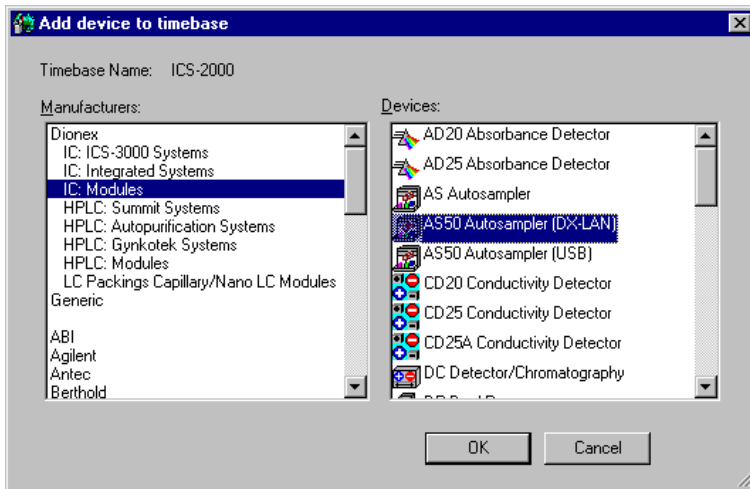

Figure B-16. Add Device to Timebase Dialog Box

- Click **OK**. A configuration properties dialog box for the device appears. [Figure B-17](#) shows an example of the properties for an AS50 Autosampler.

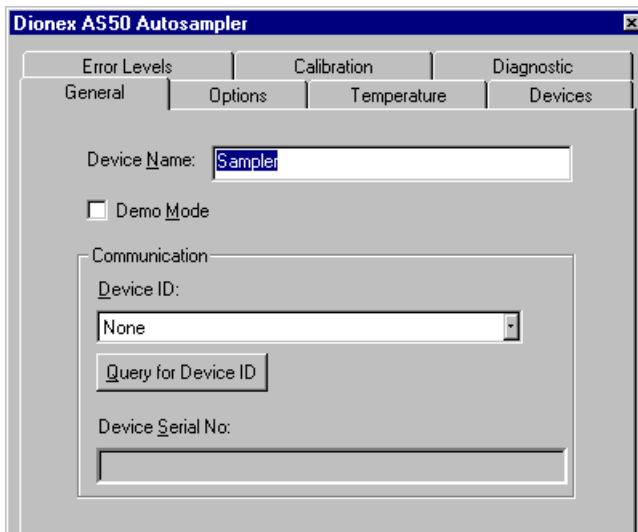

Figure B-17. AS50 Configuration Properties

5. On the **General** tab page, clear the **Demo Mode** check box if it is currently selected, and then select the DX-LAN Device ID number.
Note: Devices display their DX-LAN ID numbers when their power is turned on.
6. Click **OK** to close the dialog box.
7. Save the configuration (select **File>Save Installation**).
8. Exit the Server Configuration program.
9. Go on to [Section B.9](#).

B.9 Installing and Plumbing the Columns and Suppressor

NOTE This section provides brief installation and plumbing instructions for the columns and suppressor. Before beginning the installation, refer to the column and suppressor manuals for detailed start-up and installation instructions. The manuals are provided on the Dionex Reference Library CD-ROM (P/N 053891).

Before beginning:

- Remove the guard column, separator column, and suppressor from their boxes.
- Remove the fitting plugs from the ends of each column and from all ports on the suppressor.
- Discard any tubing temporarily connecting the suppressor ports.

B.9.1 Setting Up the Column Heater (Optional)

Follow the steps below if the optional column heater is installed.

1. Cut off the two shipping ties from the column heater and remove them (see [Figure B-18](#)).
2. Loosen the two thumbscrews on the heater cover (they remain attached to the cover).
3. Pull the heater cover straight out to remove it.

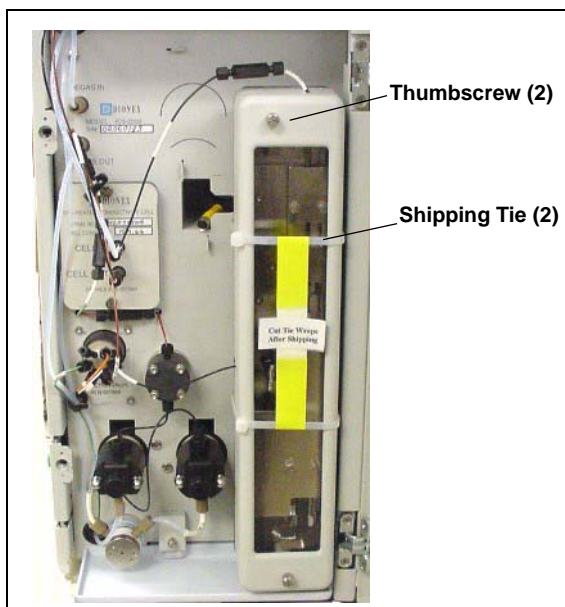

Figure B-18. ICS-1000 Column Heater Setup

4. Unscrew the six thumbscrews on the top metal plate (see [Figure B-19](#)) and remove the plate.
5. Go on to [Section B.9.2](#).

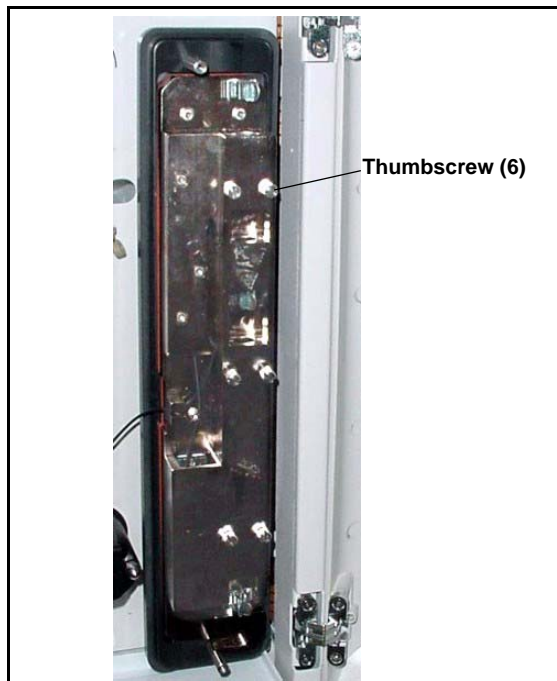

Figure B-19. ICS-1000 Column Heater Cover Removed

B.9.2 Installing the Columns

1. Remove the union connecting **GUARD IN** and **GUARD OUT**.
2. Connect **GUARD IN** to the guard column inlet. Check the arrow on the column label; it should point down (flow away from the injection valve).
3. Connect **GUARD OUT** to the guard column outlet.
4. Push the guard column onto the back column clip.
5. Remove the union connecting **COL IN** and **COL OUT**.
6. Connect **COL IN** to the separator column inlet. Connect **COL OUT** to the separator column outlet. Check the arrow on the column label. It should point up (flow toward the cell).
7. Push the separator column onto the front column clips.
8. Replace the top metal plate on the column heater (if installed).

B.9.3 Installing the Suppressor

1. Locate the suppressor mounting tabs on the component panel (see [Figure B-20](#)). Reach into the opening between the tabs and pull the yellow connector and attached cable slightly out of the opening.
2. Connect this cable to the cable from the suppressor (align the pins on the two connectors and push them together).

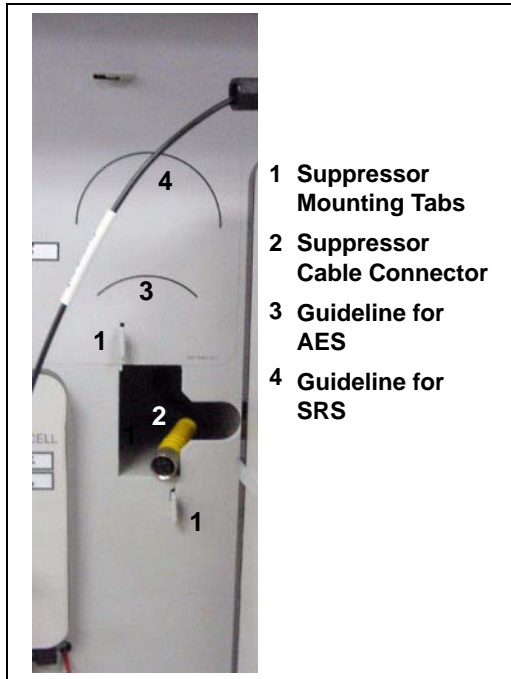

Figure B-20. Suppressor Mounting Tabs and Guidelines

3. Orient the suppressor with the **REGEN OUT** fitting on top and the cable to the right.
4. Feed the cable into the opening in the component panel.
5. Align the top of the suppressor with the guideline printed on the component panel (see [Figure B-20](#)) and align the slots on the rear of the suppressor with the tabs on the panel.

Installing and Plumbing the Columns and Suppressor

6. Press the suppressor onto the tabs and then slide it down to lock it in place. Pull slightly on the center of the suppressor to verify that it is securely fastened. [Figure B-21](#) shows an SRS suppressor installed on the component panel.
7. Remove the union connecting **ELUENT IN** and **ELUENT OUT** and connect these lines to the corresponding ports on the suppressor.



*Figure B-21. Suppressor Installed
(SRS Shown)*

8. Remove the fitting plug from **REGEN IN** and connect it to the **REGEN IN** port on the suppressor. Connect the **TO SRS/AES REGEN OUT** line to the **REGEN OUT** port on the suppressor.
9. Replace the cover on the column heater (if installed), making sure the **GUARD IN** line is aligned with the slot on the side of the heater cover.
10. Go on to [Section B.10](#).

B.10 Connecting the Waste Lines

The ICS-1000 has the following waste lines:

- **PUMP WASTE** carries prime waste from the pump.
 - **TO WASTE OUT** carries sample overflow from the injection valve.
 - **WASTE, GAS SEPARATOR** carries system waste from the suppressor.
1. Untape the coiled waste lines from the rear panel. Place the ends of the **PUMP WASTE** and **TO WASTE OUT** lines into a waste container.
 2. Direct the **WASTE, GAS SEPARATOR** line from the top of the ICS-1000 to the rear panel. Snap the line onto one of the tubing clips on the rear panel. Connect the line to the gas separator waste tube (see [Section B.10.1](#)).

NOTE To prevent waste from siphoning back into the system, check the lines periodically to be sure they are not bent, pinched, or elevated at any point.

B.10.1 Installing the Gas Separator Waste Tube

1. Locate the gas separator waste tube assembly in the ICS-1000 Ship Kit (P/N 057905).
2. Connect the **WASTE, GAS SEPARATOR** line from the suppressor to one of the 3-mm (1/8-in) ID white Teflon lines on the gas separator waste tube assembly (see [Figure B-22](#)).

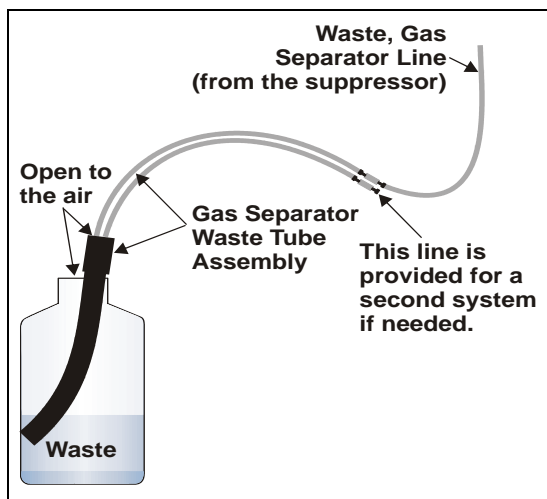

Figure B-22. Gas Separator Waste Tube Installation

3. Place the gas separator waste tube assembly into the waste container. Make sure the tubing junction (where the white Teflon tubing meets the black polyethylene tubing) is above the top of the container and

that the gas separator waste tube and the waste container are open to the atmosphere.

4. Go on to [Section B.11](#).



DO NOT CAP THE WASTE CONTAINER: The ICS-1000, Atlas Electrolytic Suppressor, and Self-Regenerating Suppressor (SRS) use an electrolytic process that results in the production of small amounts of oxygen or hydrogen gas. To ensure that the gas is not trapped in a closed container and allowed to concentrate, install a 1.3-cm (0.52-in) ID black gas separator waste tube (P/N 045460) in an uncapped waste container. Connect the Waste, Gas Separator line to the waste tube (see [Figure B-22](#)).



NE FERMEZ PAS LE CONTENEUR DE GAZ RÉSIDUEL: Le ICS-1000, le Atlas Electrolytic Suppressor, et le Self-Regenerating Suppressor (SRS) travaillent avec un proces d'électrolyse, qui produit des petites quantités de gaz d'oxygène ou d'hydrogène. Afin de garantir que le gaz ne soit pas enfermé dans un conteneur fermé et puisse s'y concentrer, connectez un tube noir à gaz résiduel (diamètre intérieur = 1,3 cm; n° de commande 045460) à un conteneur ouvert (non fermé). Connectez le conteneur résiduel au tube résiduel/gaz séparateur (désigné: « Waste, Gas Separator »).



VERSCHLIESSEN SIE DEN ABFALLBEHÄLTER NICHT: Der ICS-1000, Atlas Electrolytic Suppressor und Self-Regenerating Suppressor (SRS) verwenden einen Elektrolyseprozess, wodurch kleine Mengen an Sauerstoff und Wasserstoff entstehen. Führen Sie einen schwarzen Gasabscheiderschlauch (ID = 1,3 cm; Bestell-Nr. 045460) in einen offenen (unverschlossenen) Abfallbehälter, damit sich das Gas nicht in einem geschlossenen Behälter sammelt und aufkonzentriert. Verbinden Sie die mit Waste, Gas Separator bezeichnete Leitung mit dem Abfallschlauch.

B.11 Setting Up the Eluent Reservoir

1. Rinse the eluent reservoir.
2. Prepare the eluent as instructed in the manual for the column being installed. The column manual is included on the Dionex Reference Library CD-ROM (P/N 053891).
3. Fill the reservoir with the prepared eluent.
4. Place the reservoir on top of the ICS-1000.
5. Install the cap and handtighten.

NOTE The ICS-1000 does not require pressurized reservoirs. However, if eluent is manually degassed or is sensitive to contamination, Dionex recommends pressurizing the reservoir with helium or nitrogen. See [Section B.20](#) for instructions.

6. Go on to [Section B.12](#).

B.12 Setting Up a Chromeleon Application

Chromeleon provides application templates, which you can use to quickly get started running. To use the application templates, you need to know the type of column and suppressor you will be using. This section shows how to create a list of samples to be processed (a sequence) and how to use an application template.

1. Identify the type of column and suppressor installed in the ICS-1000.
2. Start Chromeleon (select **Start>Programs>Chromeleon>Chromeleon**).
The Chromeleon main window and Browser appear (see [Figure B-23](#)).

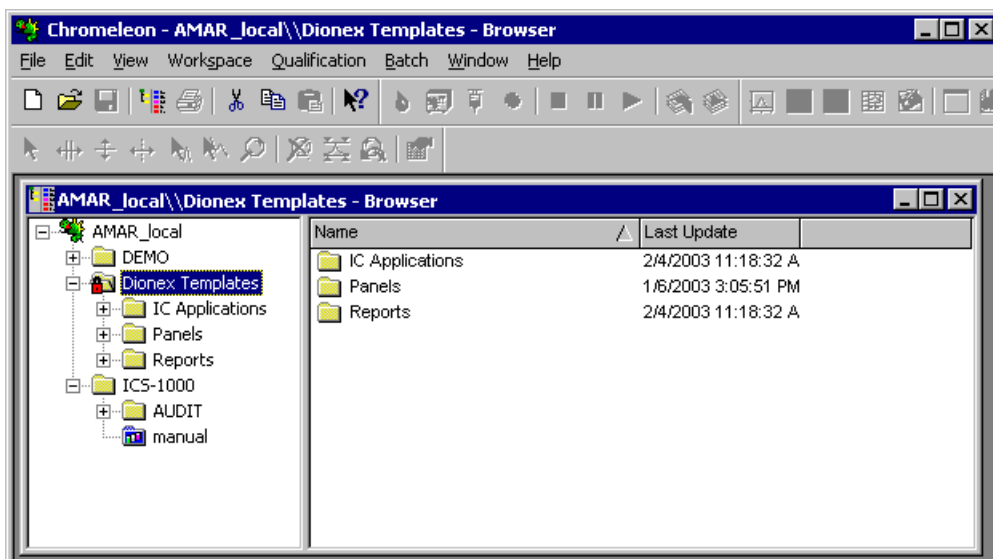

Figure B-23. Chromeleon Main Window and Browser

NOTE As an alternative to the Sequence Wizard and application templates described here, Chromeleon also includes an Application Wizard, which can be used to set up an application and create a sequence. To start the Application Wizard, go to the Browser and select **Tools>Application Wizard**. The wizard guides you through the application and sequence setup process.

3. In the Browser, select **File>New** and select **Sequence (using Wizard)** (see [Figure B-24](#)).

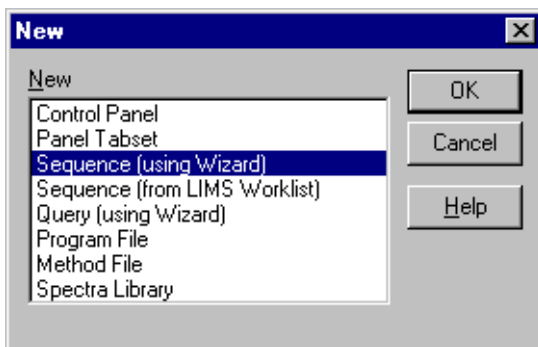

Figure B-24. Creating a New Sequence

The Sequence Wizard Welcome page appears (see [Figure B-25](#)).



Figure B-25. Sequence Wizard Welcome Page

NOTE For details about a Sequence Wizard step, click the **Help** button on the Sequence Wizard page.

4. Click **Next>**.

The Sequence Wizard Timebase page appears (see [Figure B-26](#)).

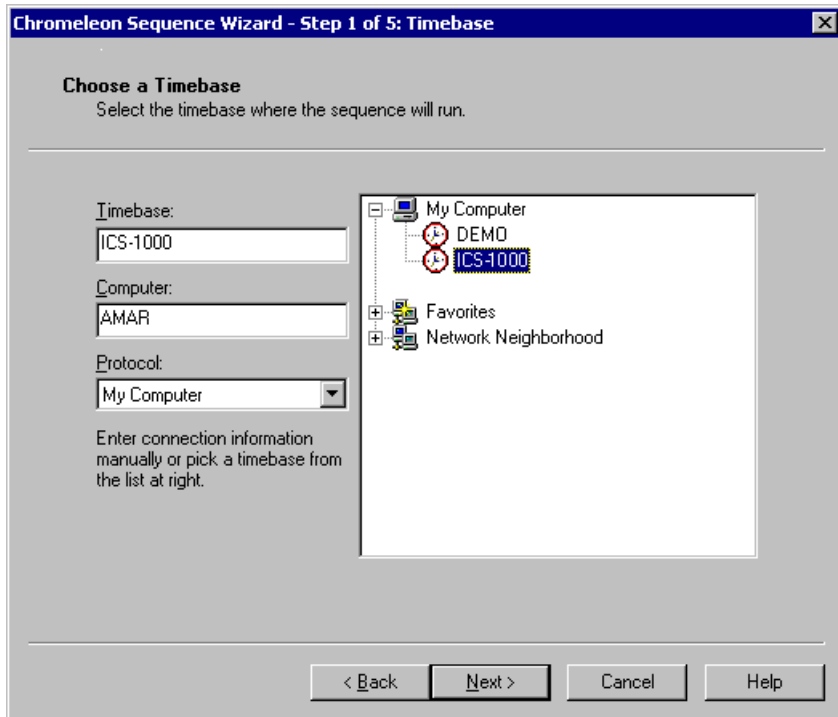

Figure B-26. Example: Sequence Wizard Step 1

5. Select the ICS-1000 timebase and click **Next>**.

The Unknown Samples page appears (see [Figure B-27](#)).

The screenshot shows the 'Unknown Samples' dialog box in the Chromeleon Sequence Wizard. The title bar reads 'Chromeleon Sequence Wizard - Step 2 of 5: Unknown Samples'. The main heading is 'Unknown Samples' with the instruction 'Generate samples from a template or import them via clipboard or from another sequence'. There are two tabs: 'Sequence Preview' (selected) and 'Rack Preview'. The 'Sequence Preview' tab contains a table with columns 'Name', 'Pos.', and 'Vol.'. Below the heading, there is a 'Use template' dropdown menu and an 'Import...' button. A 'Template for Sample Name:' field with a right arrow button is present. Below this are four input fields: 'Number of Vials:' (0), 'Injections per Vial:' (1), 'Start Position:' (1), and 'Injection Volume:' (20.0). An 'Apply >>' button is located below these fields. At the bottom of the dialog are four buttons: '< Back', 'Next >', 'Cancel', and 'Help'.

Name	Pos.	Vol.
------	------	------

Figure B-27. Example: Sequence Wizard Step 2

6. Select **Use Template** from the drop-down list.
7. In the **Template for Sample Name** field, type **Sample**, click the right arrow, and select **Sample Number #n**.
8. In the **Number of Vials** field, type **1**.
9. Use default settings for the remaining parameters on the page.

NOTE You can edit the sequence later, to add more samples and select the injection parameters appropriate for your application.

10. Click **Apply>>**.

[Figure B-28](#) shows Sequence Wizard Step 2 after a sample is defined.

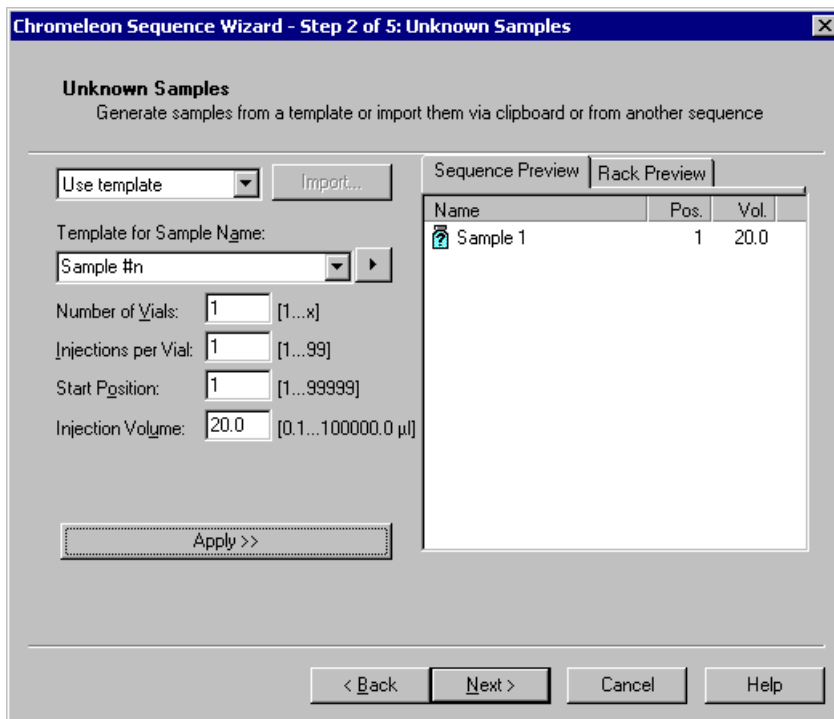

Figure B-28. Example: Sequence Wizard Step 2 with Sample Defined

11. Click **Next>**.

The Standard Samples page appears (see [Figure B-29](#)).

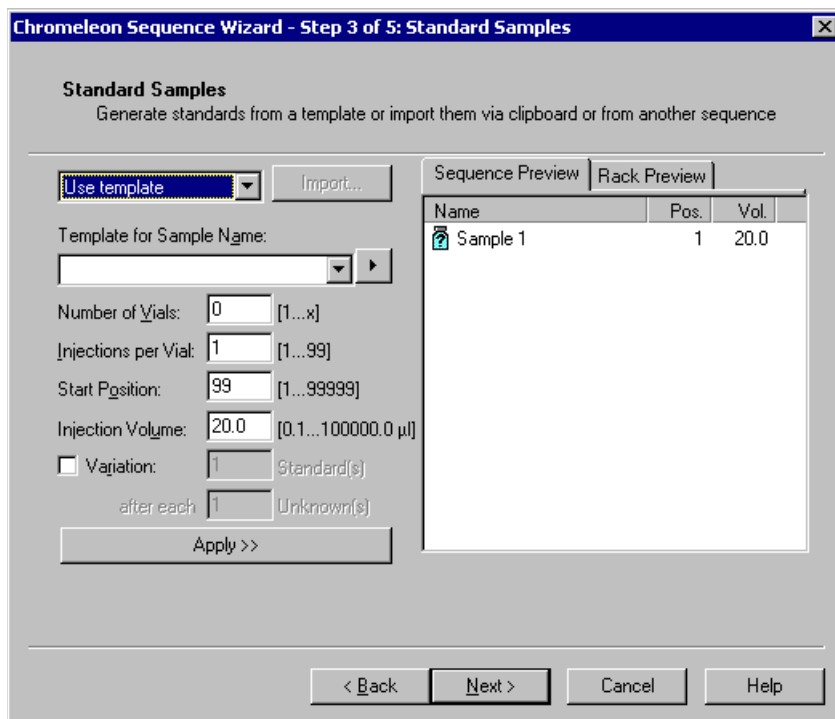

Figure B-29. Example Sequence Wizard Step 3

12. Click **Next>** to omit this step and define standard injections later. Or, define one or more standard injections, and then click **Next>**.

The Methods & Reporting page appears.

13. Select the **Use Application Template** check box.
14. From the drop-down lists, select the type of suppressor to be installed and then select the column.

In the example in [Figure B-30](#), the 4-mm ASRS suppressor and AS17 column are selected.

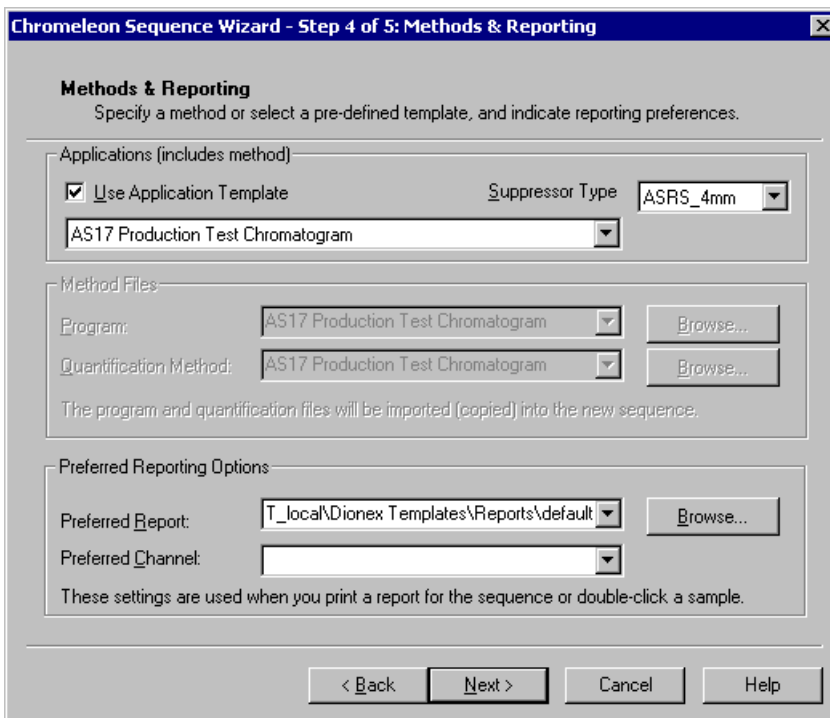
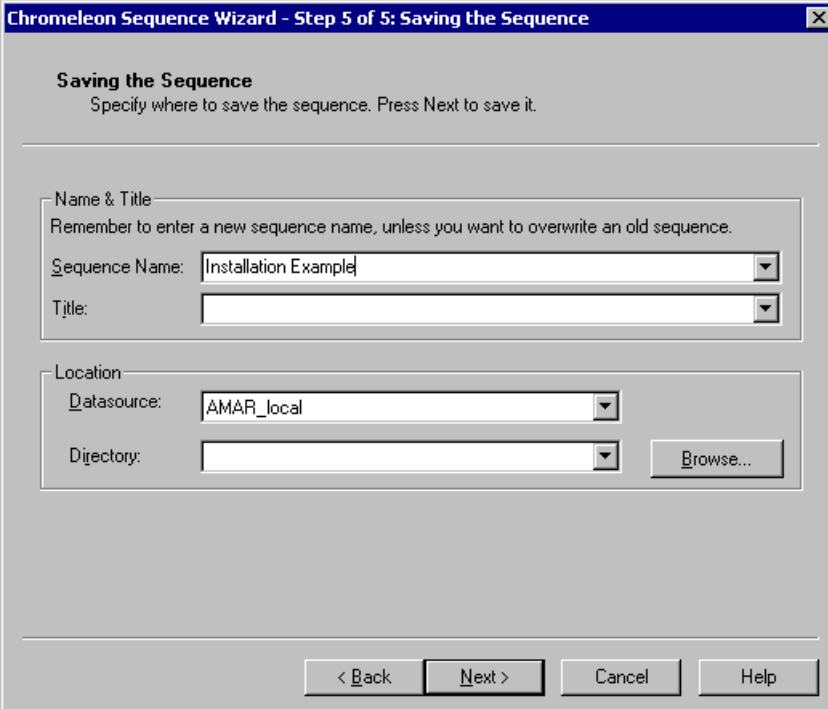

Figure B-30. Example: Sequence Wizard Step 4

15. To select a report template, click the **Browse** button, go to the Dionex Templates/Reports folder, and select a template (for example, **default**).
16. Click **Next>**.

The Saving the Sequence page appears.

17. Enter a name for the sequence and a location (see the example in [Figure B-31](#)).



The screenshot shows a dialog box titled "Chromeleon Sequence Wizard - Step 5 of 5: Saving the Sequence". The main heading is "Saving the Sequence" with the instruction "Specify where to save the sequence. Press Next to save it." The dialog is divided into two sections: "Name & Title" and "Location".

Name & Title
Remember to enter a new sequence name, unless you want to overwrite an old sequence.
Sequence Name: [Installation Example] (dropdown menu)
Title: [] (text field)

Location
Datasource: [AMAR_local] (dropdown menu)
Directory: [] (text field) [Browse...] (button)

At the bottom, there are four buttons: "< Back", "Next >", "Cancel", and "Help".

Figure B-31. Example: Sequence Wizard Step 5

18. Click **Finish>** and then click **Done** on the last page of the Sequence Wizard.

The Browser appears, displaying the sequence you created (see [Figure B-32](#)). Notice the three files in the top pane of the Browser window.

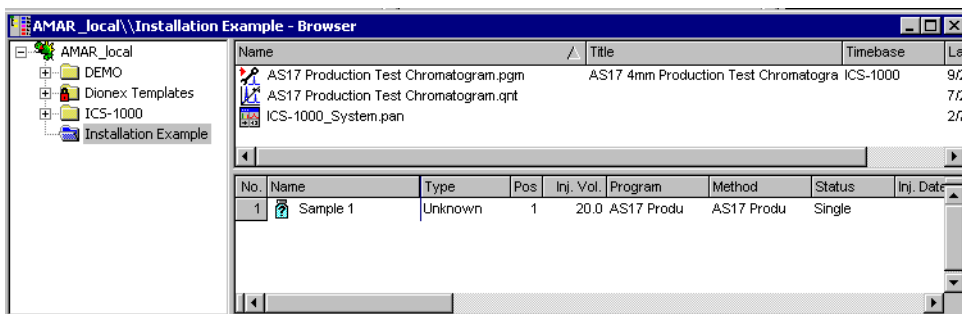

Figure B-32. Example Browser with Open Sequence

- The .pgm file (program) contains commands and parameters for controlling the ICS-1000, controlling the autosampler (if used), and acquiring sample data.
- The .qnt file (quantification method) contains peak identification and area determination parameters.
- The .pan file (Control panel) lets you control and/or monitor the ICS-1000 and other modules that are connected to the timebase.

NOTE The sequence that you create here is intended as a starting point only. You can add additional samples to the sequence, change injection parameters, and edit the .pgm and .qnt files. Refer to the Chromeleon online Help for details.

NOTE After completing the installation, see [Section 3.11](#) for how to process the samples and standards in the sequence.

19. Double-click the .pan file to open the Control panel for your system (see the example in [Figure B-33](#)).

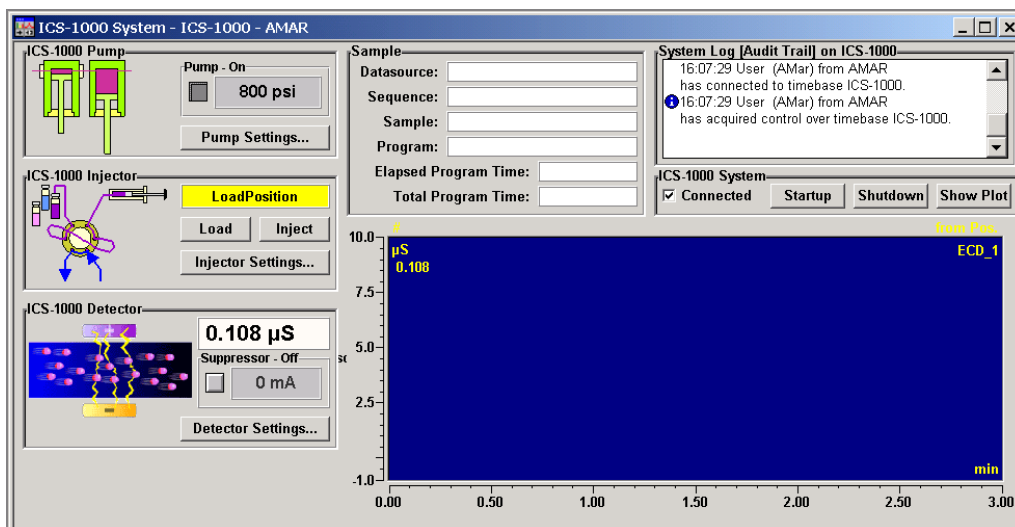

Figure B-33. ICS-1000 System Control Panel Example

NOTE If the Connected check box is not selected, click the box to connect the ICS-1000 to the Control panel.

B.12.1 Verifying Chromeleon Communication

Verify that Chromeleon is communicating with the ICS-1000 by clicking the **Inject** and then the **Load** button on the Control panel. If communication is occurring, you will hear the valve actuate as it changes position. Go on to [Section B.13](#).

B.13 Setting the Eluent Level

After filling the reservoir, enter the volume of liquid in the reservoir on the Chromeleon Control Panel (see [Figure B-34](#)). The ICS-1000 determines the eluent usage by monitoring the flow rate and the length of time the pump is on, and updates the **Eluent Level** field as the eluent is used up. A warning appears if the level falls below 200 mL. Warnings are repeated at 100 mL and 0 mL.

IMPORTANT

In order for the eluent level displayed on the Control Panel to be accurate, the level must be entered by the user when the reservoir is filled. The ICS-1000 does not automatically detect when the reservoir is filled, nor when it is empty.

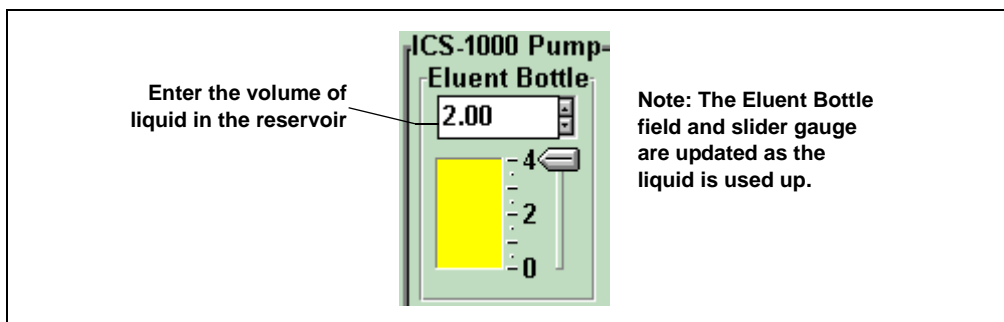

Figure B-34. Setting the Eluent Level

B.14 Priming the Pump

1. Verify that the eluent reservoir is filled, the reservoir cap is installed and hand tightened, and the liquid line from the ICS-1000 to the reservoir cap is connected (see [Section B.11](#)).
2. Verify that the waste lines are directed to a waste container.
3. The priming procedure consists of two parts:
 - Priming the eluent lines with a syringe. Perform this procedure at initial installation, after changing eluents, or when eluent lines are empty.
 - Priming the pump heads with the **Prime** button. Perform this procedure after the eluent lines are primed.

B.14.1 Priming the Eluent Lines with a Syringe

NOTE Prime the eluent lines after initial installation, after changing eluents, or when eluent lines are empty.

1. Verify that the pump is turned off.
2. Connect a 10 mL syringe (P/N 054578) to the port in the priming valve on the primary pump head (see [Figure B-35](#)).

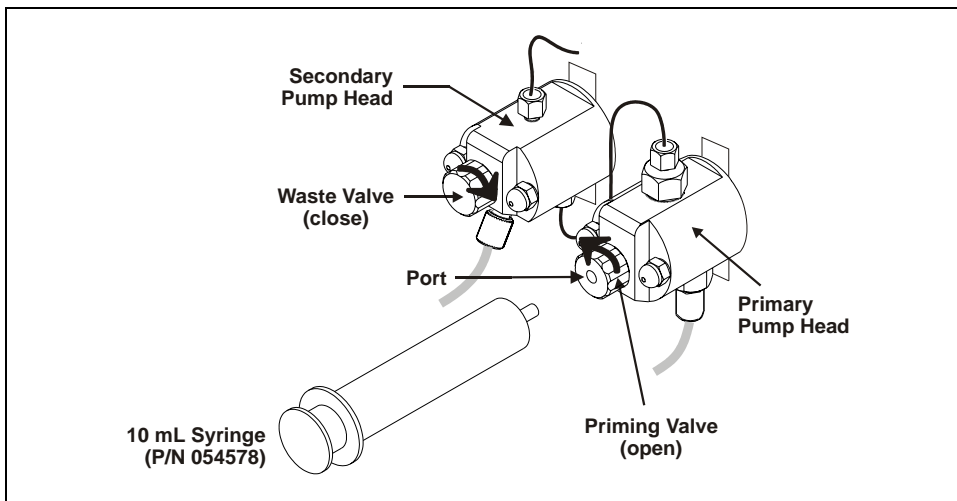

Figure B-35. Priming the Eluent Lines

3. Open the priming valve by turning it one-quarter to one-half turn counterclockwise.
4. On the Chromeleon Control Panel, click **Pump Settings** and then click **Eluent Flow Valve Open** (see [Figure B-36](#)).

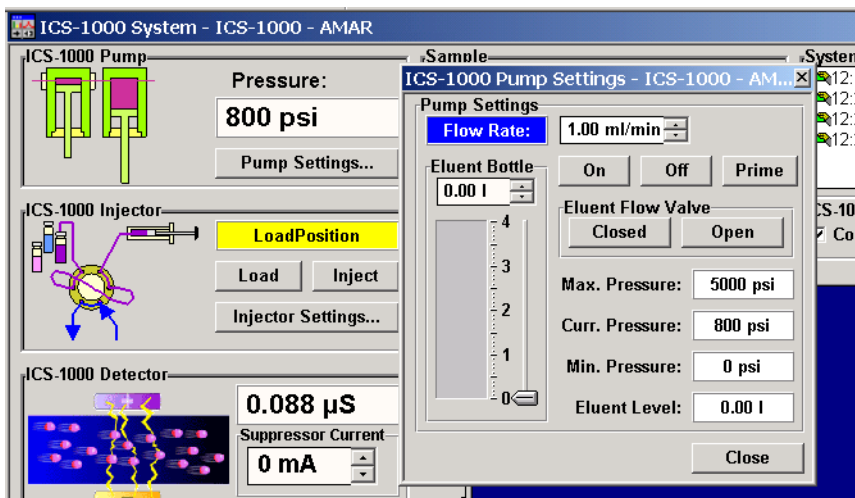

Figure B-36. Chromeleon Control Panel: Pump Settings

5. Draw the syringe back to begin pulling eluent through the flow path. It may take several syringe draws to remove all air or previous eluent from the tubing.

NOTE If the vacuum degas assembly is installed, draw out an additional 20 mL of eluent.

6. After priming the lines thoroughly, close the priming valve. **Do not overtighten the priming valve.**
7. Close the eluent valve (click **Eluent Flow Valve Closed** on the Control Panel).

B.14.2 Priming with the Prime Button

NOTE Perform this procedure after priming the eluent lines (see [Section B.14.1](#)).

1. Check that the priming valve on the primary pump head is closed (see [Figure B-37](#)).

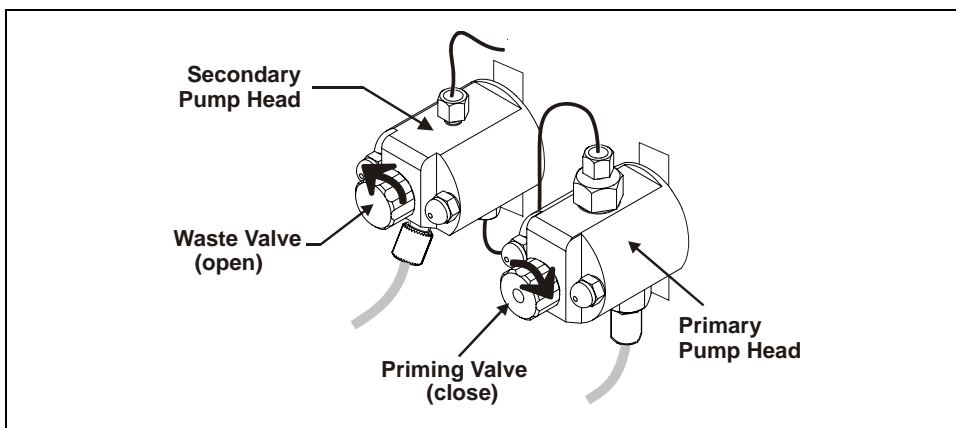

Figure B-37. Priming the Pump

2. Open the waste valve on the secondary pump head by turning the knob one-quarter to one-half turn counterclockwise (see [Figure B-37](#)). Opening the valve directs the eluent flow path to waste and eliminates backpressure.
3. Click **Prime** on the Chromeleon Control Panel (see [Figure B-36](#)). The pump will begin pumping at approximately 3 mL/min.
4. Continue priming the ICS-1000 until no air bubbles are exiting the pump waste line.
5. Press **Pump Off**.
6. Close the waste valve. **Do not overtighten**. The pump is now ready for operation.

NOTE If the two standard priming procedures described above are unsuccessful, prime the pump with isopropyl alcohol. See [Section 5.15](#) for instructions.

B.15 Equilibrating the System

1. After priming the pump, turn on the pump and set the flow to the operating rate.
2. Flush the system for about 5 minutes to equilibrate.
3. Monitor the system pressure from the Chromeleon Control panel to make sure it is at the expected pressure for the installed column (refer to the column manual for details) and is stable. If the pressure is less than the expected amount, gas may be trapped in the system. Release the gas by removing the pump fitting on the injection valve. The fitting is labeled **P (2)**. Allow the air to escape and then reconnect the fitting.
4. Check that liquid is flowing out of the suppressor **REGEN OUT** waste line and that the pressure is stable.
5. Monitor the baseline conductivity. In general, it should be $<30 \mu\text{S}$ for a system set up for anion analyses, and $<2 \mu\text{S}$ for a system set up for cation analyses. Equilibration time varies and it can take some time to reach these expected values.

B.16 Verifying Operational Status

After the system has equilibrated, verify the actual pump pressure and stability by monitoring the pump pressure reading on the Chromeleon Control panel. Write down the short-term pressure fluctuations; they should be less than 0.13 MPa (20 psi).

This completes the ICS-1000 installation procedure. For routine operating instructions, refer to [Chapter 3](#).

B.17 Connecting an AS or AS50 (USB) Autosampler (Optional)

To use an AS or AS50 (USB) autosampler with the ICS-1000, the following requirements must be met:

- The ICS-1000 injection valve must be linked to the AS or AS50 (USB) in the Chromeleon timebase (see [Section B.17.2](#))
- An injection valve should not be installed in the AS or AS50 (USB) (see the note below)

After the AS or AS50 (USB) is connected to the ICS-1000 and the valve is linked in Chromeleon, all autosampler injection valve commands will control the ICS-1000 injection valve (whether issued from the AS or AS50 (USB) front panel or from Chromeleon). In addition, all AS or AS50 (USB) modes of injection (full-loop, partial-loop, partial-loop limited-sample, and others) are supported.

NOTE Dionex recommends using AS or AS50 (USB) models that do not have injection valves (see the list below). If a valve is installed in the autosampler, it is switched at the same time as the valve in the ICS-1000. This causes unnecessary wear on the autosampler valve. If required, the autosampler valve can be disconnected from the AS or AS50 (USB) electronics. If you wish to do this, contact Dionex for assistance. The AS or AS50 (USB) electronics components cannot be serviced by the user.

The following AS50 (USB) and AS models can be used with an ICS-1000:

Part Number	Autosampler Model	Injection Valve	Sample Preparation	Sample Tray Cooling
061130	AS50 (USB)	No	No	Yes
061132	AS50 (USB)	No	Yes	Yes
061134	AS50 (USB)	No	No	No
061136	AS50 (USB)	No	Yes	No
063102	AS	No	No	No
063103	AS	No	Yes	No
063106	AS	No	No	Yes
063107	AS	No	Yes	Yes

B.17.1 AS or AS50 (USB) Connections

1. Place the autosampler to the left of the ICS-1000 on the workbench.
2. Open the ICS-1000 and autosampler doors.
3. The needle seal line that extends from the inject port in the autosampler is coiled inside the autosampler door, on the right side. Route this line through the autosampler right side slot (see [Figure B-38](#)) and the ICS-1000 left side slot to the ICS-1000 injection valve.

IMPORTANT

The needle seal line from the autosampler inject port to the ICS-1000 injection valve is calibrated for use with the ICS-1000. To ensure injection precision, do not shorten (by cutting) or lengthen this line, or replace it with a different (uncalibrated) line.

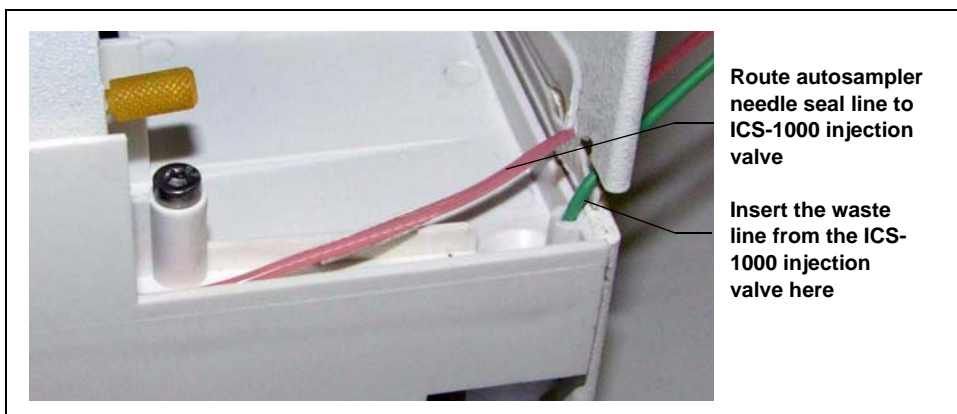

Figure B-38. Autosampler Drip Tray

4. Connect the needle seal line from the autosampler to port **S (5)** on the injection valve (see [Figure B-39](#)).

The green waste line that is connected to port **W (6)** on the injection valve (see [Figure B-39](#)) is connected with a union to a Teflon waste line (see [Figure B-40](#)) and routed through the tubing chase to the ICS-1000 rear panel.

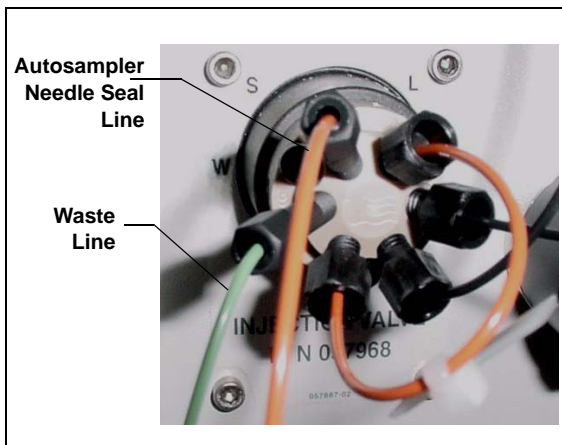

Figure B-39. ICS-1000 Injection Valve

5. Disconnect the green waste line (labeled **AS/AS50 TRAY**) from the union and route the line to the drip tray in the autosampler compartment.

You can either leave the disconnected Teflon waste line and union in the tubing chase, or pull the line out from the front.

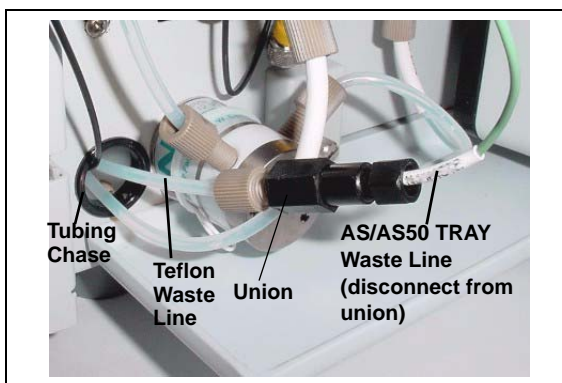

Figure B-40. Injection Valve Waste Line Union

6. Push the end of the green **AS/AS50 TRAY** line into the small round opening on the right side of the AS or AS50 (USB) tray (see [Figure B-38](#)).

IMPORTANT

Make sure the injection valve waste line is not elevated above the injection valve at any point between the valve and the autosampler drip tray.

NOTE Bend the waste line tubing about 5-mm from the end to ensure it stays in place in the opening in the drip tray. When bending the tubing, be sure not to restrict the inner diameter.

B.17.2 AS or AS50 (USB) Chromeleon Setup

1. If you have not already done so, add the autosampler to the Chromeleon timebase (see [Section B.8](#)).
2. In the ICS-1000 Server Configuration properties, verify that the injection valve is controlled by the autosampler. To do this:
 - a. Open the Chromeleon Server Configuration program and select the ICS-1000 device in the timebase.
 - b. Select **Properties** on the **Edit** menu.
 - c. Select the **Inject Valve** tab.
 - d. Verify that the **Pump_InjectValve** check box is selected and that **AS** is listed in the **Controlled By** column (see [Figure B-41](#)).
 - e. If **ICS-1000** is listed in the **Controlled By** column, select the **Pump_InjectValve** name and press the **F2** key. A dialog box appears. Select **AS** in the **Controlled by** drop-down list.

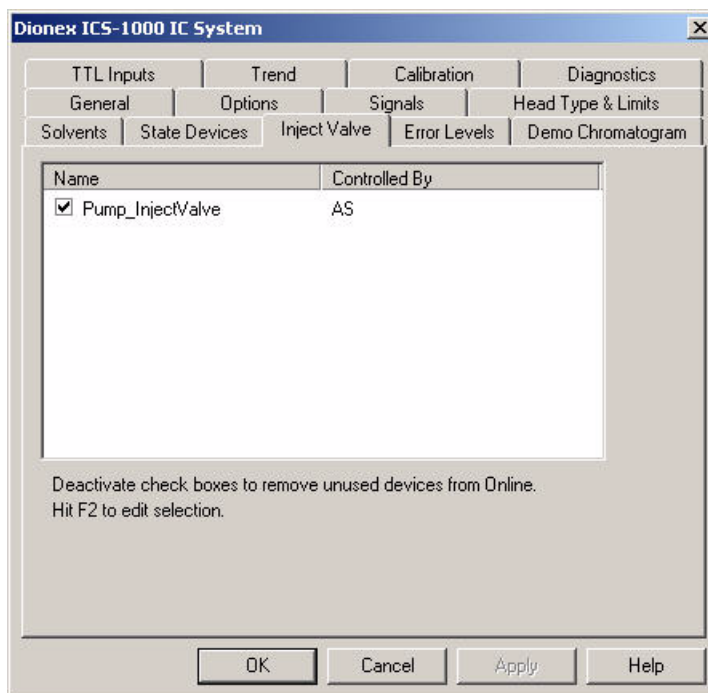

Figure B-41. ICS-1000 Inject Valve Server Configuration Properties

B.18 Connecting an AS40 Automated Sampler (Optional)

1. Place the AS40 to the left of the ICS-1000 on the workbench.
2. Open the front door of the ICS-1000 and thread the outlet line from the AS40 through the left side slot at the front of the ICS-1000.
3. Connect the outlet line from the AS40 to port **S (5)** of the injection valve (see [Figure B-42](#)).



Figure B-42. ICS-1000 Injection Valve

4. Locate the relay control cable (P/N 047946) supplied with the AS40.
5. Remove the 2-position connector plug from the pair of wires labeled **LOAD** on the relay control cable.
6. Locate the 12-position connector plug (P/N 923686) in the ICS-1000 Ship Kit (P/N 057905) (see [Figure B-43](#)).
7. Attach the red wire from the relay control cable to position 1 on the plug, and attach the green wire to position 2. This will be used to connect the AS40 **LOAD** relay to **RELAY OUT 1** on the ICS-1000.

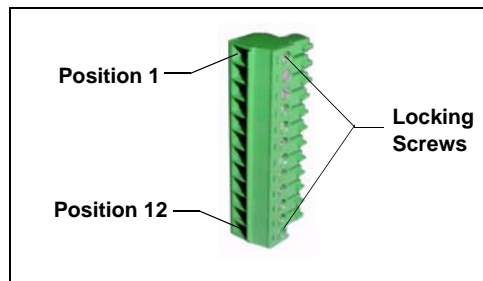

Figure B-43. 12-Position Connector Plug

To attach a wire to the plug, strip the end of the wire, insert it into the plug, and use a screwdriver to tighten the locking screw.



When attaching wires to the connector plug, be careful not to allow stray strands of wire to short to the adjoining position on the connector.

Connecting an AS40 Automated Sampler (Optional)

NOTE If RELAY OUT 1 is not available, you can connect to RELAY OUT 2 or to one of the TTL outputs. For RELAY OUT 2, connect the red wire to position 3 and the green wire to position 4. For TTL OUT 1, connect the red wire to position 5 and the green wire to position 11. For TTL OUT 2, connect the red wire to position 6 and the green wire to position 12.

8. Connect the relay control cable's 10-position connector plug to the **RELAY CONTROL** connector on the AS40 rear panel (see [Figure B-44](#)).
9. Plug the 12-position connector plug into the TTL and relay connector on the ICS-1000 rear panel (see [Figure B-44](#)). Make sure the red wire connects to position 1 and the green wire connects to position 2.

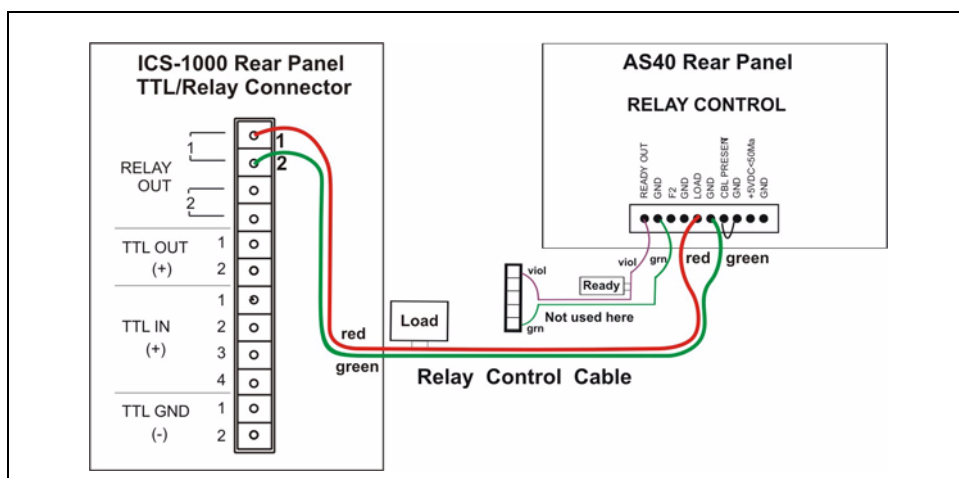

Figure B-44. Example AS40 Autosampler Connection

The AS40 Load relay is now dedicated to the ICS-1000 **RELAY OUT 1**. Use this relay for running with Chromeleon. When you set up the ICS-1000 application (see [Section B.12](#)), commands for controlling the AS40 Load relay and switching

the ICS-1000 injection valve are included by default in the program file (see [Figure B-45](#)).

```
AS12A Production Test Chromatogram - Commands
nm Production Test Chromatogram
  suppressor_current = 2.5
  Flow = 1.50
-2.300 Pump_ECD_Relay_1.Closed Duration=138.00 ; For AS40 injection.
0.000 Pump_ECD.Autozero
      ECD_1.AcqOn
      Pump_InjectValve.InjectPosition Duration=30.00
15.000 ECD_1.AcqOff
      End
```

Figure B-45. Example Program for AS40 Control

B.19 Analog Output Connection (Optional)

The analog output connector on the ICS-1000 rear panel outputs an analog voltage signal proportional to the conductivity measured by the cell. The selected data rise time filters the output. The analog output can be connected to an analog-to-digital converter such as an integrator or other recording device. Refer to the documentation for the device for connection instructions.

Analog output is 0 to 1V, scaled to the selected range.

B.20 Pressurizing the Eluent Reservoir (Optional)

The ICS-1000 does not require pressurized reservoirs. However, if eluent is manually degassed or is sensitive to contamination, Dionex recommends pressurizing the reservoir with helium or nitrogen. The air regulator accessory bracket and other items needed for pressurizing the eluent reservoir must be ordered separately (P/N 060054).

B.20.1 Connecting the Gas Source (Optional)

1. Locate the barbed fitting (P/N 030071), pipe thread reducer (P/N 030087), 3-mm (1/8-in) ID tubing (P/N 040793), and ICS-1000

Pressurizing the Eluent Reservoir (Optional)

air regulator accessory (P/N 060054). These parts must be ordered separately.

2. Use the barbed fitting and pipe thread reducer to connect the 3-mm (1/8-in) ID tubing to a clean gas source, regulated to between 0.55 and 0.83 MPa (80 and 120 psi).
3. Push the other end of the tubing onto the inlet of the air regulator (see [Figure B-46](#)).
4. Remove the eluent reservoir cap.
5. Connect the gas line from the eluent reservoir cap to the gas line on the air regulator outlet.s
6. Slip the air regulator accessory bracket over the neck of the eluent reservoir (see [Figure B-46](#)).

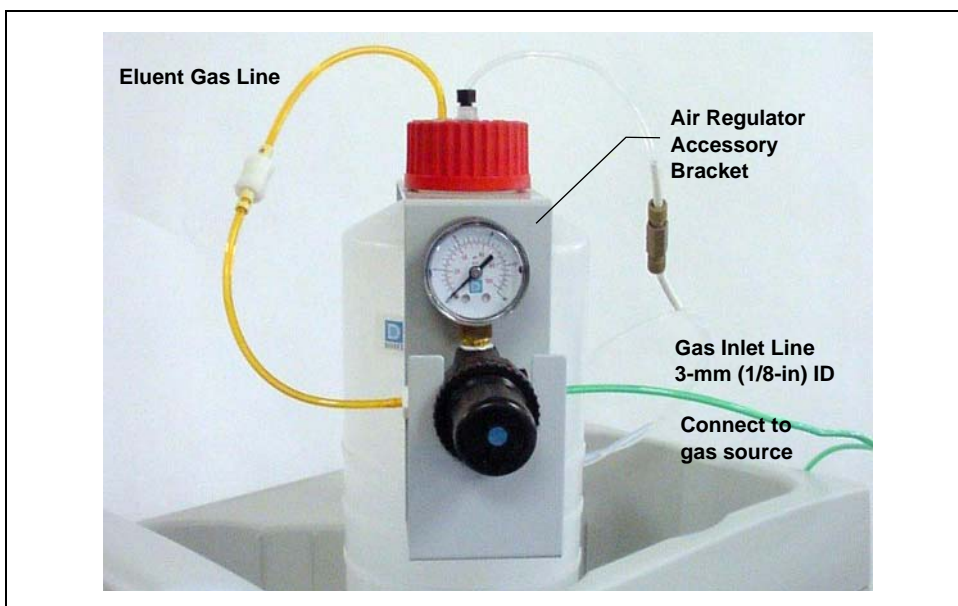

Figure B-46. ICS-1000 Pressurized Eluent Reservoir Connections (Optional)

B.20.2 Pressurizing the Eluent Reservoir (Optional)

NOTE Do not pressurize the ICS-1000 until after the reservoir is plumbed.

1. Pull out the air regulator knob and turn it fully counterclockwise to ensure there is no pressure to the reservoir when the gas source is turned on.
2. Turn on the gas source.
3. Pull out the air regulator knob and turn it clockwise to pressurize the eluent reservoir.
4. Adjust the pressure to between 0.03 and 0.04 MPa (5 and 6 psi). Push the regulator knob back in.



Do not pressurize the eluent reservoir above 0.07 MPa (10 psi).



Ne mettez jamais les réservoirs d'éluants sous une pression supérieure à 0,07 MPa (10 lb/po²).



Setzen Sie den Eluentbehälter auf keinen Fall einem Druck über 0,07 MPa aus.

B.21 Pump Continuous Seal Wash Connections (Optional)

The pump includes a seal wash assembly that can be set up to continuously rinse the back of the piston seals to remove salt crystals and prolong the life of the seals. Follow the steps below to set up this feature.

1. Fill a flush bottle with either deionized water or a combination of deionized water and 10% or 20% isopropyl alcohol. (Isopropyl alcohol will inhibit bacterial growth in the water.)
2. Place the flush bottle on top of the ICS-1000. During operation, gravity maintains flow through the pump heads.
3. The flush solution is carried to the piston seal wash assembly and out to waste via 1.5-mm (0.06-in) ID tubing (P/N 055847). Locate this tubing in the ICS-1000 Ship Kit and cut the tubing into three unequal pieces in the following lengths:
 - 117 cm (46 in)
 - 152 cm (60 in)
 - 15 cm (6 in)
4. Install the tubing as follows (see [Figure B-47](#) and [Figure B-48](#)):
 - a. Push the 117-cm (46-in) piece of clear tubing onto the drain tube on the bottom of the *secondary* pump head. Place the free end of this tubing in the flush bottle. Make sure the end of the tubing is near the bottom of the bottle.



Figure B-47. Primary and Secondary Pump Heads with Drain Tubes

ICS-1000 Ion Chromatography System

- b. Push the 152-cm (60-in) piece of clear tubing onto the drain tube on the top of the *primary* pump head. This is the waste line. Route this waste line through the lower tubing chase and out the back of the ICS-1000.
- c. Push the 15-cm (6-in) piece of clear tubing over the drain tube on the top the *secondary* pump head. Push the other end of the tubing over the drain tube on the bottom of the *primary* pump head.
- d. Place a 10 mL syringe (P/N 054578) at the end of the waste line, press the syringe against the line to form a seal, and draw out all of the air.
- e. Push approximately 5 cm (2 in) of black 0.25-mm (0.01-in) ID tubing (P/N 057057) into the end of the waste line.

NOTE The black tubing creates a flow restriction. Assuming a height difference of about 76 cm (30 in) between the flush bottle and the waste container, this setup provides a flow of one drop of flush solution every 5 to 30 seconds.

- f. Place the end of the waste line in a waste container.
- g. This completes the piston seal wash installation. Periodically refill the flush bottle and empty the waste container as required.

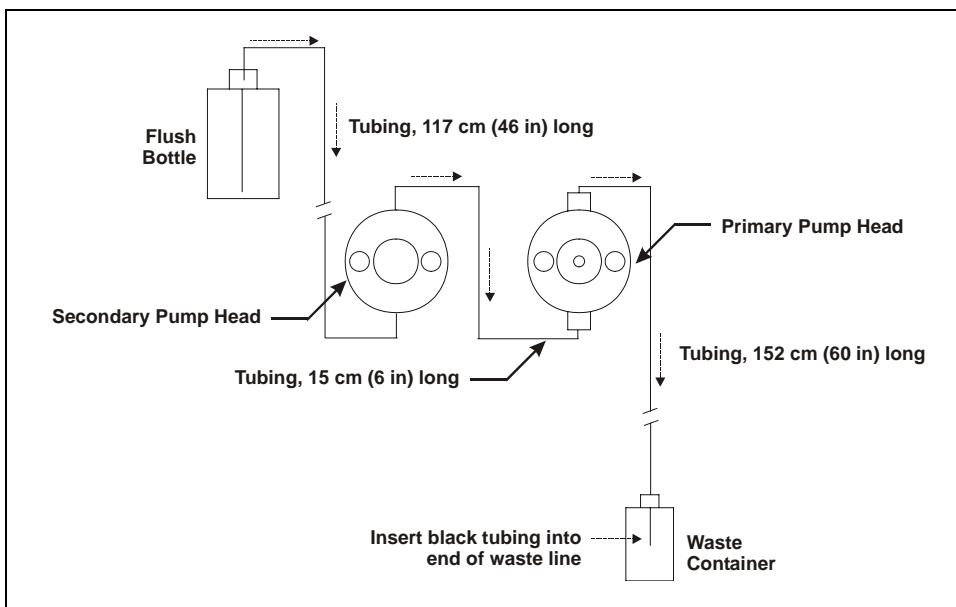

Figure B-48. Piston Seal Wash Flow Schematic

B.22 Manually Connecting to a Control Panel

This section describes how to manually connect the ICS-1000 to a Control panel if you do not use the application templates described in [Section B.12](#).

1. In the Browser, expand the **Dionex Templates\Panels\Dionex_IC\ICS-1000 System Panels** folder. Several System Control panels, corresponding to various system configurations, are provided.
2. Open the panel for your system configuration by double-clicking its name in the list. For example, if your system includes an ICS-1000 and an AS50 autosampler, double-click either **ICS-1000_System_AS50.pan** or **ICS-1000_Traditional_System_AS50.pan**.

NOTE The two types of panels (system and traditional system) are similar in function, but have different “looks.” You can select either style, depending on your personal preference.

When the Control panel opens, the controls on the panel are not enabled (see [Figure B-49](#)).

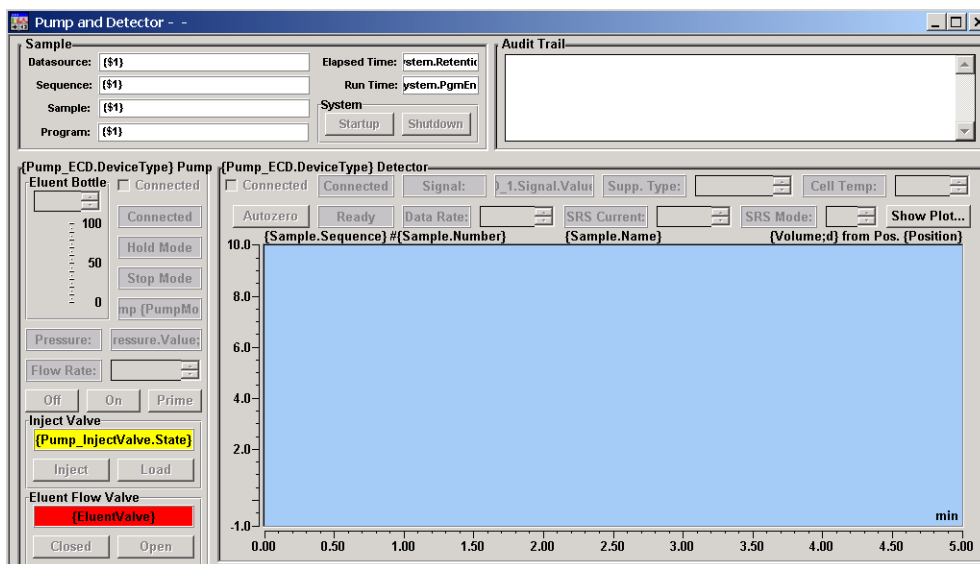

Figure B-49. ICS-1000 Traditional System Control Panel (Unconnected)

ICS-1000 Ion Chromatography System

- To connect the Control panel to the ICS-1000, open the **Control** menu and click the name of the ICS-1000 timebase at the bottom of the menu.

The Control panel is now connected to the ICS-1000 and the controls are enabled (see [Figure B-50](#)).

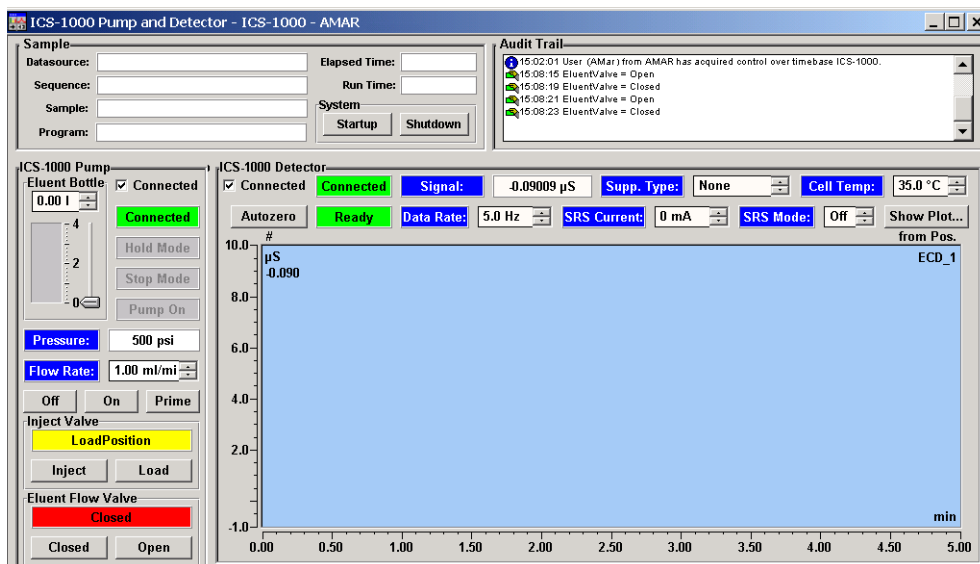

Figure B-50. ICS-1000 Traditional System Control Panel (Connected to the ICS-1000)

B.23 Installation Troubleshooting

Problem: When the ICS-1000 power is turned on for the first time, a Windows message box appears asking for a USB configuration file (cmwdmusb.inf).

Possible Cause: The USB cable was connected and the power turned on before Chromeleon was installed.

Solutions:

Follow these steps to resolve the problem:

1. Click **Cancel** in the Windows message box.
2. Turn off the power to the USB device and unplug the USB cable from the computer.
3. Install Chromeleon (see [Section B.4](#)).
4. Reconnect the USB cable to the computer and turn on the power to the device. Windows will now automatically recognize the USB device.

C • TTL and Relay Control

C.1 TTL and Relay Connections

A 12-pin connector strip for TTL/relay control is located on the ICS-1000 rear panel. The connector provides two relay outputs, two TTL outputs, and four TTL inputs (see [Figure C-1](#)).

Pin Function	Connector Position	Description
RELAY OUT	1	Solid State Relay Contacts Output
	2	
	3	
	4	
TTL OUT (+)	5	TTL Output 1 (1 k Ω pull up to +5, 100 mA sink)
	6	TTL Output 2 (1 k Ω pull up to +5, 100 mA sink)
TTL IN (+)	7	TTL Input 1 — Inject/Load
	8	TTL Input 2 — Autozero
	9	TTL Input 3 — Pump/Suppressor On
	10	TTL Input 4 — Mark
TTL GND (-)	11	Ground
	12	Ground

Note: The TTL input functions can be reassigned to different inputs.

Figure C-1. TTL and Relay Connector on Rear Panel



Relay loads in excess of 200 mA or with included power supplies over 60 V may damage the relay drivers on the CPU.

The outputs can be used to control functions in external devices such as an autosampler or another Dionex module. When connected to a controlling device, the inputs can be programmed to perform the following ICS-1000 functions:

- Switch the injection valve position (load/inject)
- Perform an autozero command (set the conductivity to zero)
- Turn the pump on and off (also turns the suppressor on and off)
- Send a chart mark signal to the analog output. The mark is 10% of the full-scale voltage, and the duration is 0.5 seconds. A mark can be used, for example, to indicate the injection.

Relay outputs 1 and 2 can be programmed to switch any low-voltage control. Switched current must be less than 200 mA and 42 V peak.

Connecting a TTL or Relay

1. Locate the twisted pair of wires (P/N 043598) and the 12-position connector plug (P/N 923687) (see [Figure C-2](#)) in the ICS-1000 Ship Kit (P/N 057905).

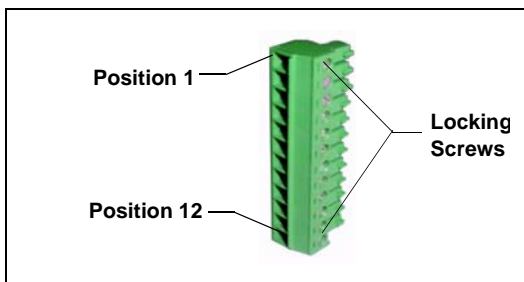

Figure C-2. 12-Position Connector Plug

2. Follow these basic steps to connect the TTL or relays.
 - a. For each relay or TTL to be used, connect an active wire (red) and a ground wire (black) to the 12-position connector plug at the appropriate pin locations. Refer to [Figure C-1](#) or the label on the ICS-1000 rear panel for the connector pin assignments.

To attach a wire to the plug, strip the end of the wire, insert it into the plug, and use a screwdriver to tighten the locking screw. If necessary, multiple ground wires can be attached to a single TTL input/output ground pin.



When attaching wires to the connector plug, be careful not to allow stray strands of wire to short to the adjoining position on the connector.

- b. Plug the connector into the 12-pin connector on the ICS-1000 rear panel.

- c. Connect the wires from the ICS-1000 connector plug to the TTL or relay connector pins on the other module(s). Additional connector plugs are provided with other Dionex modules.

NOTE Check the polarity of each connection. Connect signal wires to signal (+) pins and ground wires to ground (-) pins.

3. If you connected a TTL input, verify that the correct function is assigned to the input and that the correct input control type is selected. Select different settings if necessary. Input functions and control types are assigned from Chromeleon (see [Section C.1.1](#)).

C.1.1 Selecting TTL Input Functions and Control Types

To select TTL input functions and the control type, open the Chromeleon Server Configuration program and double-click the ICS-1000 icon under the timebase. Select the **TTL Inputs** tab (see [Figure C-3](#)).

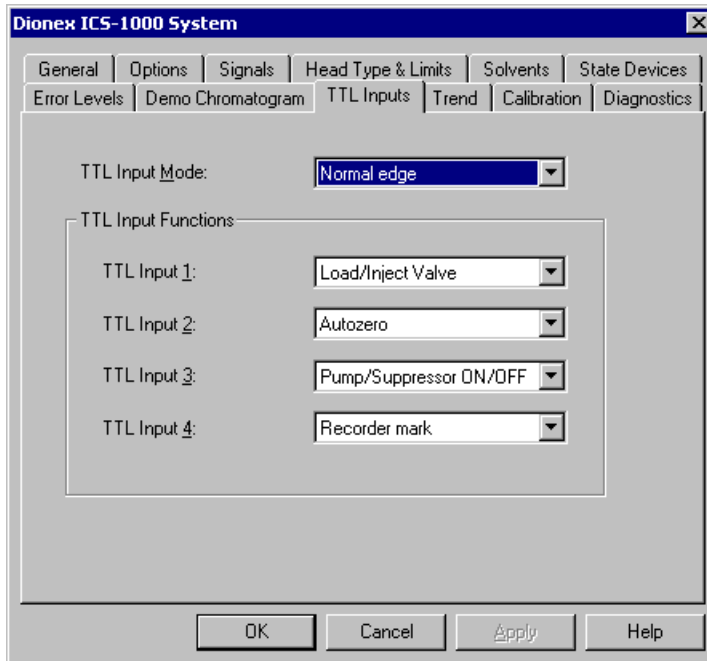

Figure C-3. ICS-1000 Server Configuration Properties: TTL Inputs

TTL Input Control Types

Normal Edge
Normal Pulse
Inverted Edge
Inverted Pulse

The ICS-1000 TTL inputs respond to four types of signals to accommodate different controlling devices. The default control type, **Normal Edge**, is compatible with the output signals provided by Dionex modules.

If the device connected to the ICS-1000 does not send a normal edge signal, select the appropriate control type. Refer to the documentation provided with the controlling device and the information below to select the correct type.

- Normal Edge:* In normal edge operation, the negative (falling) edge of a signal turns on the function. For example, for the **Load/Inject** function, the negative edge switches the injection valve position to Load.

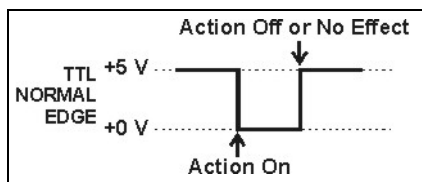

The action of the positive (rising) edge depends on the function: For the **Load/Inject** function, the rising edge switches the injection valve to the Inject position. For the **Pump On** function, the rising edge turns off the pump (and suppressor). For **Autozero** and **Mark**, the rising edge has no effect.

- Inverted Edge:* The inverted edge mode works identically to the normal edge mode except that the positive and negative edges are reversed in function.

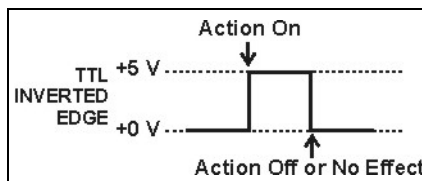

- Normal Pulse:* In normal pulse operation, the negative (falling) edge of the TTL signal is the active edge and the positive (rising) edge is ignored.

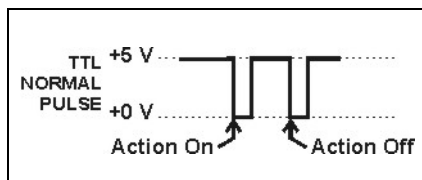

A pulse width of 50 ms or more is guaranteed to be detected. A pulse width of 4 ms or less is guaranteed to be ignored. The action for pulse widths that are greater than 4 ms and less than 50 ms is undefined.

- *Inverted Pulse:* The inverted pulse mode operates identically to the normal pulse mode except that the positive and negative edges are reversed in function.

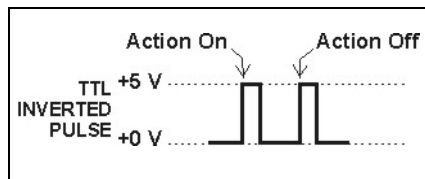

C.2 Controlling TTL and Relay Outputs

The ICS-1000 provides two TTL outputs and two relay contacts for control of functions in external devices, such as an integrator or autosampler. The relay outputs can be used to switch any low-voltage control. Switched current must be less than 200 mA and 60 V peak blocking. The relay-contact closures are normally open. When the relay is closed, current flows to the connected device.



Relay loads in excess of 200 mA or with included power supplies over 60 V may damage the relay drivers on the CPU.

The TTL outputs are normally at 5 volts. Setting a TTL output to 0 volts turns on the action in the connected device.

The TTL and relay output states can be controlled, either by issuing direct control commands from the Chromeleon Control panel or by including the commands in a control program. [Figure C-4](#) shows an example relay program command for controlling an AS40 autosampler.

```

AS12A Production Test Chromatogram - Commands
mm Production Test Chromatogram
Suppressor_Current = 2.9
Flow = 1.50
-2.300 Pump_ECD_Relay_1.Closed Duration=138.00 ; For AS40 injection.
0.000 Pump_ECD.Autozero
ECD_1.AcqOn
Pump_InjectValve.InjectPosition Duration=30.00
15.000 ECD_1.AcqOff
End

```

Figure C-4. Example Program for AS40 Control

D • Reordering Information

Part Number	Item
<i>Reservoirs</i>	
046548	2-L plastic reservoir assembly (includes stopper and cap)
039164	4-L plastic reservoir assembly (includes stopper and cap)
<i>Pump</i>	
057937	Primary pump head assembly
057938	Secondary pump head assembly
045721	Outlet check valve assembly, 10-32
045722	Inlet check valve assembly, 1/4-28
045994	Check valve cartridges
052840	Piston
055870	Piston seal
048722	Piston rinse seal
055752	O-ring for waste valve or priming valve
057945	Eluent valve
054578	10-cc syringe (for priming eluent lines)
<i>Sample Loop and Injection Valve</i>	
042857	25- μ L sample loop
057968	Injection valve
024305	Luer adapter fitting, 1/4-28 (for manual injections)
016388	1-cc syringe (for manual injections)
057896	Injection valve rebuild kit
<i>Suppressors, Cell, and Column Heater</i>	
056116	AAES Anion Atlas Electrolytic Suppressor
056118	CAES Cation Atlas Electrolytic Suppressor
053946	ASRS-Ultra 4-mm Anion Self-Regenerating Suppressor
053949	CSRS-Ultra 4-mm Cation Self-Regenerating Suppressor

ICS-1000 Ion Chromatography System

Part Number	Item
057985	DS6 heated conductivity cell
058060	Column heater assembly
059979	Column heater heat exchanger, 0.25-mm (0.010-in) ID tubing
060943	Column heater heat exchanger, 0.125-mm (0.005-in) ID tubing
058062	Column heater cover assembly
<i>Relay/TTL</i>	
923686	12-position connector plug
043598	Twisted pair of wires
<i>Miscellaneous</i>	
954745	IEC 127 fast-blow fuses, rated 3.15 amps
060494	USB cable, 5 m (16 ft)
060392	External USB hub
058053	Leak detector
<i>Maintenance Kits</i>	
055647	AS40/ASM Preventive Maintenance Kit
060581	AS/AS50 Preventive Maintenance Kit
057954	ICS-1000 Preventive Maintenance Kit

E.1 How do I hook up an autosampler?

For instructions on how to connect the ICS-1000 to an AS or AS50 autosampler, see [Section B.17](#) of this manual. To connect an AS40, see [Section B.18](#). Also refer to the autosampler operator's manuals, which are included on the Dionex Reference Library CD-ROM (P/N 053891).

E.2 How do I print?

Click the Print toolbar button in Chromeleon (see [Section 2.3](#)).

E.3 Why are the retention times moving?

Retention times can shift if the pump flow is erratic or if the column or eluent is contaminated. See [Section 4.6](#) for pump flow rate troubleshooting. If a contaminated column is suspected, clean the column as instructed in the column manual. The column manual is included on the Dionex Reference Library CD-ROM (P/N 053891).

E.4 How do I adjust retention times?

Retention times are calculated during calibration. The **Use Recently Detected Retention Time** parameter in the Chromeleon QNT Editor (**General** tab) can be used to compensate for some types of retention time drifts; for example, evaporation of volatile components in pre-mixed solvents or an aging column. Refer to the Chromeleon online Help or user's guide for details.

E.5 When should I remake standards?

Standards are used only for calibration and should always be made fresh (they have a lifetime of only one week).

E.6 When should I remake eluents?

Eluents should be remade every two or three weeks.

E.7 How do I start Chromeleon?

Click **Start** on the Windows taskbar, and then select **Programs >Chromeleon > Chromeleon**.

E.8 How do I delete data?

In the Chromeleon Browser, highlight the sequence you want to delete and then select **File >Delete**.

E.9 How do I back up data?

In Chromeleon, select **File >Export/Backup**. Back up the data and indicate the backup source.

E.10 How do I shut off the system?

In Chromeleon, click the **System Shutdown** button on the Control panel (see [Figure 2-8](#)). On the ICS-1000, turn off the power switch on the rear panel (see [Figure 2-5](#)).

E.11 How do I store columns?

Columns should be stored in eluent. See the column manual for complete instructions. The column manual is included on the Dionex Reference Library CD-ROM (P/N 053891).

E.12 How do I know when a column is dirty?

See the troubleshooting section of the column manual.

E.13 How do I clean a column?

See the troubleshooting section of the column manual.

E.14 Why is the conductivity high?

Possible reasons for high conductivity include:

- The suppressor needs regeneration. See the suppressor manual for troubleshooting information. The suppressor manual is included on the Dionex Reference Library CD-ROM (P/N 053891).
- The cell is out of calibration. See [Section 5.1.2](#) for calibration instructions.
- See [Section 4.12](#) for additional troubleshooting information.

Analytical Column

Synonymous with **Separator Column**.

Band Spreading

The broadening of the sample band as it travels through the column. Band spreading can also occur in the injection valve, detector cell, and interconnecting tubing.

Calibration Curve

A graph showing detector response in peak height or area versus analyte concentration.

Capacity Factor (k')

The number of column volumes of eluent, pumped through the column, required to elute an analyte. Capacity factor is a dimensionless measure of retention which is independent of column length or eluent flow rate. It is calculated as follows:

$$k' = \frac{t_r - t_o}{t_o}$$

Where: t_r = retention time

t_o = retention time of unretained solute (column void volume)

Cell Constant (k)

A factor determined experimentally by measuring the conductance (G) of a standard solution of known equivalent conductivity (κ).

$$k = \kappa / G$$

The value of k depends upon the surface area of, and distance between, the electrode faces in the conductivity detector cell.

$$k = l / A$$

Where: l = length

A = area of one electrode (the other electrode is equal to the first)

Channeling

The preferential flow of liquid along more open, less resistant paths through the column packing. This causes **Band Spreading**.

Column Efficiency (N)

A measure of the *narrowness* of analyte bands as they elute from the column. High efficiency is desirable because resolution between closely spaced bands improves with greater efficiency. For a symmetrical (Gaussian) peak, column efficiency can be determined by the following:

$$N = 5.54(t_1/W_{1/2})^2$$

Where: t_1 = the peak retention time (in seconds)

$W_{1/2}$ = the peak width at 1/2 height (in seconds)

Column efficiency is proportional to column length: for a given resin and column diameter, increasing the column length increases the column efficiency.

Synonymous with **Theoretical Plates**.

Column Selectivity (a)

Describes the relative separation of the band maxima between two adjacent peaks. Selectivity can be determined by the following:

$$a = (t_2 - t_0)/(t_1 - t_0)$$

Where: t_1 and t_2 = retention time of components 1 and 2, respectively

t_0 = retention time of unretained components (void volume)

Concentrator Column

A short column used to retain and concentrate analytes from a measured volume

of relatively clean sample. This allows large volumes of sample to be injected, lowering concentration detection limits.

Conductivity

A measure of the ease with which electrical current flows through a liquid contained between two opposite charged electrodes. Conductivity is a characteristic of ions in solution. Units are siemens.

Counterion

Ions carrying a charge opposite that of the sample ions (e.g., Na⁺) may be the counterion of a Cl⁻ analyte. These ions preserve electrical neutrality in solution.

% Crosslink

Divinylbenzene content in a polystyrene/divinylbenzene (PS-DVB) resin; this contributes to the mechanical strength of the resin and determines chromatographic properties.

Equivalent Conductivity (λ)

The contribution of an ionic species to the total conductivity of a solution as measured in a standard cell having electrodes 1 cm² in area and exactly 1 cm apart.

Guard Column

A small column that prevents poisoning of the separator column by sorbing organic contaminants and removing particulates. It is filled with the same packing as the separator column. Synonymous with **Pre-Column**.

HETP (H)

Height **E**quivalent to a **T**heoretical **P**late. A measure of column efficiency which allows comparison between columns of different lengths.

$$\text{HETP} = H = L/N$$

Where: L = the column length (in mm)

N = the number of theoretical plates

Ion-Exchange Capacity

The number of active ion exchange sites in a given weight or volume of resin; this is usually expressed in meq/g or meq/mL.

Ion-Exchange Resin

An insoluble polymer matrix containing fixed-charge exchange sites (anionic or cationic). IC resins are formed into small spherical particles (beads).

Packing

The material that fills a chromatographic column; usually a resin or silica-based material.

Pellicular Resin

A resin with a solid, nonporous core coated with a thin layer of more porous material. The exchange sites of pellicular ion exchange resins are located only on the surface layer of the bead. These resins have a low ion-exchange capacity.

Pre-Column

Synonymous with **Guard Column**.

Regenerant

A dilute acid or base that converts ion exchange sites in a MicroMembrane Suppressor back to the form that suppresses the eluent conductivity.

Resin

See **Ion-Exchange Resin**.

Resolution (R)

A measure of the separation between two sample components. This is expressed as the ratio of the distance between the two peak maxima to the mean value of the peak width at the baseline.

$$R = 2(t_2 - t_1)/(W_2 + W_1)$$

Where: t_1 and t_2 = the retention times of components 1 and 2, respectively

W_1 and W_2 = the baseline width of peaks 1 and 2, respectively (measured in the same units as the retention time)

R is proportional to the square root of efficiency (N). A value of $R = 1.5$ represents “baseline separation” of the two peaks.

Retention Time

The time from injection to peak maximum; the basis for identification of a species in chromatographic analysis.

Separator Column

The column used to perform a chromatographic separation; also called an analytical column.

Siemens (S)

Unit measure of conductance; the reciprocal of the electrical resistance of a solution.

Suppressor

A device used to minimize eluent conductivity and convert sample species to a common form, thus increasing detection sensitivity.

Temperature Coefficient

The percent of change in the conductivity of a solution with a 1 °C change in temperature. Every solution has a characteristic temperature coefficient which is determined experimentally.

Theoretical Plates (N)

See **Column Efficiency**.

Void Volume (V_0)

The volume occupied by the eluent in a packed column. This volume includes the volume between the injection valve and the column, as well as between the column and the detector cell. Unretained components are eluted in the void volume.

A

- Air particulate samples, 3-12
- Air regulator, B-50, B-52
- Alarm conditions, 4-3 – 4-8
 - See also* Error messages
- Ambient temperature, 4-19
- Analog output, C-2
 - Connector, 2-7
- Anion separations, 3-11
- AS/AS50 (USB) Autosampler
 - Installation, B-44
 - Sample injection, 3-15
 - Yearly maintenance, 3-21
- AS40 Automated Sampler
 - Installation, B-48
 - Sample injection, 3-15
 - Yearly maintenance, 3-21
- Atlas Electrolytic Suppressor, 2-6
 - See also* Suppressor
- Audit Trail, 2-16
 - Error messages, 4-1
 - Icons, 4-1
- Automated control, 2-11
- Autosampler
 - Loading samples with, 3-15
 - See also* AS/AS50 (USB) Autosampler
 - See also* AS40 Automated Sampler
- Autozero, 2-17, 3-10, 3-17

B

- Background conductivity
 - High, 4-18
 - Offsetting, 3-10
- Backpressure, 2-23
 - Restriction in plumbing, 5-7
 - Troubleshooting, 4-15

Baseline

- Drift, 4-19
- Equilibration, B-43
- Noise, 2-10, 4-19
- Stability, 2-27
- Batch processing, 3-2
 - Starting, 3-19
 - See also* Sample processing
- Blockages
 - Liquid lines, 4-6, 5-7
- Bottle
 - See* Reservoir
- Browser, 2-12, 3-5, B-55

C

- Cables
 - AS40 Relay Control, B-48
 - Power cord, 5-30
 - USB, B-9
- Calibration, 5-1
 - Conductivity cell, 5-4
 - Flow rate, 5-6
 - Vacuum degas assembly, 5-7
- Cation separations, 3-11
- Cell
 - See* Conductivity cell
- Cell calibration, 5-4
- Cell drive, A-3
- Check valves
 - Cleaning procedure, 5-11 – 5-12
 - Replacement procedure, 5-11 – 5-12
- Chromatogram, 1-3
- Chromeleon, 2-11
 - Adding devices to a timebase, B-19
 - Alarm conditions, 4-3
 - Audit Trail, 4-1
 - Audit Trail error messages, 4-1

- Browser, 2-12, 3-5
- Control panel, 2-11, 3-17
- Creating a sequence, 3-18
- Degas options, 4-20
- Direct control, 2-11
- Error messages, 4-3
- Installation, B-5, B-14
- Interface, 2-11
- License installation, B-5 – B-6
- Menu, 2-11, 3-17
- Programs, 2-11, 2-15, 3-15 – 3-16
- Starting, 3-4, B-29
- System properties dialog box, B-18
- Timebase, 3-5
- Toolbars, 2-11, 3-17
- Verifying communication, B-38
- Wellness panel, 5-1
- Chromeleon Server
 - Starting, 3-4, B-12
- Chromeleon Server Configuration program
 - Timebase, B-17
- Column heater, 2-5, 2-26
 - Chromeleon control, 2-17
 - Replacement procedure, 5-23
 - Specifications, A-4
- Column heater alarms
 - Column heater exceeds safe temperature, 4-3
 - Column heater open circuit, 4-3
 - Column heater short circuit, 4-3
- Columns, 2-5
 - Cleaning, E-2 – E-3
 - Contaminated, 4-17
 - Damage from IPA, 5-30
 - Installing, B-22
 - Storing, E-2
- Commands
 - Chromeleon, 2-11, 3-18, B-37
- Component panel, 2-4
- Computer
 - Connections, B-9
 - Operating system requirements, B-5
 - Unpacking, B-4
- Conductivity

- Causes of high conductivity, E-3
 - Temperature effect, 2-27
- Conductivity cell, 2-6, 2-27
 - Calibrating, 5-4
 - Calibration constant, 5-21
 - High cell output, 4-18
 - Leaking, 4-11
 - No response, 4-18
 - Replacement procedure, 5-20
 - Specifications, A-3
 - Volume, 2-27
- Conductivity cell specifications
 - Active volume, A-3
 - Cell body, A-3
 - Electrodes, A-3
 - Maximum pressure, A-3
- Contacting Dionex, 5-1
- Contamination
 - Column, 4-16 – 4-17
 - Eluents, 4-16
 - Sample, 4-17
 - Standard, 4-16
- Control panel, 3-17
- Control panel (Chromeleon), 2-11, 2-13
 - System panel, 2-13 – 2-18
 - Wellness panel, 2-13

D

- Daily maintenance, 3-20
- Data
 - Backing up, E-2
 - Deleting, E-2
 - Saving, 3-18
- Data acquisition, 3-17
- Data analysis description, 1-3
- Data rise time, B-50
- Decibel level, A-1
- Degas tubing assembly
 - See* Vacuum degas assembly
- Degas calibration failed alarm, 4-3
- Degassing eluents, 2-19, 3-6
- Delay volume, A-2

Detection description, 1-3
Detector controls on Control panel, 2-17
Detector specifications
 Cell drive, A-3
 Linearity, A-3
 Range, A-3
 Temperature compensation, A-3
Diagnostics, 5-1
Dimensions, A-1
Dionex
 Contacting, 5-1
Direct control, 2-11
Dongle, B-6
Drip tray, 2-5
DS6 Heated Conductivity Cell
 See Conductivity cell
Duty cycle, 2-20

E

Electrical specifications
 Fuses, A-1
 Main power, A-1
Eluent
 Aqueous, 3-20, 4-12
 Degassing, 2-19
 Delivery process, 1-2
 Filtering, 3-7
 Preparing, 3-6
 When to remake, E-2
Eluent bottle
 See Eluent reservoir
Eluent level, 3-8, B-39
Eluent reservoir
 Connecting, 3-8, B-28
 Filling, 3-7
 Gas connection, B-50 – B-51
 Monitoring liquid level in, 3-8, B-39
 Pressurization, B-52
 Storage on top cover, 2-3
Eluent valve, 2-5
 Chromleon control, 2-17
 Replacing, 5-26

End-line filter
 See Filter, end-line
Environmental specifications
 Humidity, A-1
 Operating pressure, A-1
 Operating temperature, A-1
Equilibration time, 3-10
Error messages, 4-3 – 4-8
 Audit Trail description, 4-1
 Column heater exceeds safe temperature, 4-3
 Column heater open circuit, 4-3
 Column heater short circuit, 4-3
 Degas calibration failed, 4-3
 Hardware not present, 4-4
 Leak sensor wet, 4-4
 Load/inject valve error, 4-4
 Option not installed, 4-5
 Pressure slope calibration error, 4-5
 Pump motor lost control, 4-5
 Pump over pressure, 4-6
 Pump pressure hardware error, 4-6
 Pump under pressure, 4-6
 Suppressor not connected, 4-8
 Suppressor over current, 4-7
 Suppressor over power, 4-7 – 4-8
 Suppressor stopped for zero flow rate, 4-8

F

Facility requirements, B-1
Filter, end-line
 Bacterial contamination, 3-20, 4-12
 Dirty or clogged, 3-20, 4-12
 Installation, 3-7
Fittings
 Leaking, 4-9
 Replacing, 5-9
 Requirements, 5-9
Flow rate, 2-5, A-2
 Calibration, 5-6
 Troubleshooting, 4-14
Flow schematic, 2-9

FROM PC

USB connections, B-9

Front panel, 2-1

Specifications, A-2

Fuses

Replacement procedure, 5-30

Requirements, A-1

G

Gas separator waste tube, B-26

Installation, B-27

Gas source

Connection, B-50

Installation, B-51

Pressure requirement, B-51

Ghosting, 4-16

Guard column, 2-5, B-22

Installation, B-23

H

Hardware not present error, 4-4

Heater, column, 2-26

See also Column heater

High pressure alarm, 4-6

High pressure limit, A-2

Humidity limits, A-1

I

Injecting samples, 3-13

Via autosampler, 3-15

Via syringe, 3-14

Via vacuum syringe, 3-14

Injection port, 2-1

Injecting via syringe, 3-14

Injection valve, 2-5, 2-24

Chromeleon control, 2-17

Leaking, 4-10

Plumbing connections, 2-24

Rebuilding, 5-10

Specifications, A-3

Troubleshooting, 4-5

Installation, B-1 – B-57

Adding devices to a timebase, B-19

AS/AS50 (USB) Autosampler, B-44

AS40 autosampler, B-48

Assigning devices to a timebase, B-17

Chromeleon, B-5, B-14

Columns, B-22

Computer, B-4

Eluent reservoir, B-28, B-52

Equilibrating the system, B-43

Gas separator waste tube, B-26

Gas source, B-50 – B-51

Guard column, B-23

Key code, B-8

Operating system requirements, B-5

Operational status verification, B-43

PC connections, B-9

Plumbing, B-28

Power connection, B-11

Priming, B-40 – B-42

Separator column, B-23

Software license, B-5 – B-6

Starting the ICS, B-12

Suppressor, B-24

TTL and relay connections, C-1 – C-2

Unpacking, B-2

USB connections, B-9 – B-10

Waste lines, B-26

Installation troubleshooting, B-57

Inverted edge TTL input control, C-4

Inverted pulse TTL input control, C-5

Ion chromatography

Overview, 1-1

Ion exchange, 1-3

Isocratic delivery system, 1-2

Isopropyl alcohol, 5-29 – 5-30

K

Key code (Chromeleon), B-6

L

- Leak sensor, 2-5
 - Leak sensor wet alarm, 4-4
 - Replacement, 5-28
- Leaks
 - Cell, 4-11
 - Fittings, 4-9
 - Injection valve, 4-10
 - Liquid, 4-9
 - Pressure transducer, 4-10
 - Pump check valve, 4-9
 - Pump head, 4-10
 - Pump head waste valve, 4-10
 - Pump piston seal, 4-10
 - Suppressor, 4-10
- LED, A-2
- License (Chromeleon), B-5 – B-6
- License server (Chromeleon), B-6
- Linearity requirements, A-3
- Liquid leaks, 4-9
 - See also* Leaks
- Load/inject valve alarm, 4-4
- Loading samples, 3-13
- Loop
 - See* Sample loop
- Low pressure limit, A-2

M

- Main power receptacle, 2-8
- Maintenance, 3-20
 - Daily, 3-20
 - Ongoing, 3-20
 - Weekly, 3-20
 - Yearly, 3-21
- Manual sample processing, 3-2
- MicroMembrane Suppressor, 2-6
 - See also* Suppressor
- Moduleware, 4-1

N

- Nitrite in samples, 3-12
- Normal edge TTL input control, C-4
- Normal pulse TTL input control, C-4

O

- Offsetting background conductivity, 3-10
- Operating features, 2-1
- Operating pressure, A-1
- Operating ranges
 - Cell heater, 2-6
 - Column heater, 2-5
 - Flow rate, 2-5
- Operating system requirements, B-5
- Operating temperature, A-1
- Operation
 - Equilibration time, 3-10
 - Overview, 3-1
 - Priming, 3-9, 5-29, B-42
 - Reservoir setup, 3-6
 - Sample preparation, 3-11
 - Sample processing, 3-2
 - Setting operating conditions, 3-10
 - Starting Chromeleon, 3-4
 - System power-up, 3-3
- Operational status verification, 3-10
- Option not installed error, 4-5
- Oven
 - See* Column heater
- Overview, 1-4

P

- Panels
 - Chromeleon Control panel, 2-11, 3-17
 - Chromeleon Wellness panel, 5-1
 - Component panel, 2-4
- Parameters
 - Chromeleon operating commands, 2-11, 3-18, B-37

ICS-1000 Ion Chromatography System

- PC See Computer
- Peak ghosting, 4-16
- Peak height
 - Reproducibility, 2-27
 - Troubleshooting, 4-17
- Peaks
 - Extraneous (ghosting), 4-16
- PEEK
 - Conductivity cell body, 2-27
- Physical specifications
 - Decibel level, A-1
 - Dimensions, A-1
 - Weight, A-1
- Piston seals
 - Replacement procedure, 5-13 – 5-14, 5-16 – 5-17
- Pistons
 - Replacement procedure, 5-17
- Plot, 2-17 – 2-18
- Plotting detector output, 2-18
- Plumbing
 - Columns and suppressor, B-28
 - Injection valve, 5-10
 - Replacing tubing and fittings, 5-9
 - Troubleshooting, 5-7
- Power
 - Turning on, 3-3, B-12
- Power cord, 5-30, B-11
- Power receptacle, 2-8, B-11
- Power requirements, A-1
- Power-up conditions, 3-3
- Pressure
 - Limit, 4-7
 - Pump operating specifications, A-2
 - System, 4-7
- Pressure ripple, A-2
- Pressure slope calibration error, 4-5
- Pressure transducer, 2-5, 2-23
 - Leaking, 4-10
 - System backpressure, 2-23
- Pressurizing
 - Eluent reservoir, B-52
- Priming, 3-9, 5-29, B-40 – B-42
 - Pump is out of prime, 4-12
 - With a syringe, B-40
 - With isopropyl alcohol, 5-29
 - With the Prime button, B-42
- Priming valve
 - Opening, 2-22
 - O-ring replacement procedure, 5-18
- Printing, E-1
- Problems
 - See Troubleshooting
- Processing samples, 3-2, 3-17 – 3-18
 - Automatically (batch), 3-2, 3-18
 - Manually, 3-2, 3-17
- Product warranty, 5-1
- Program time, 2-15
- Programs (Chromeleon), 2-11, 2-15
 - AS/AS50 (USB) example, 3-16
 - AS40 example, 3-16
 - Controlling an autosampler, 3-15
 - Run time, 2-15
- Pulse damper, 2-10, 2-23
- Pump, 2-21
 - Chromeleon control, 2-17
 - Flow rate, 2-5
 - Leaks, 4-10
 - Operating pressure, A-2
 - Over pressure alarm, 4-6
 - Primary pump head, 2-21
 - Priming, 3-9, B-40
 - Priming problems, 4-11
 - Secondary pump head, 2-22
 - Troubleshooting, 4-13
 - Under pressure alarm, 4-6
- Pump check valve leaking, 4-9
- Pump components, 2-21
- Pump degas
 - See Vacuum degas assembly
- Pump head waste valve
 - Leaking, 4-10
 - O-ring replacement procedure, 5-18
- Pump heads, 5-11
- Pump motor lost control alarm, 4-5
- Pump pressure hardware error, 4-6
- Pump priming valve
 - O-ring replacement procedure, 5-18

Pump specifications

- Flow rate, A-2
- Operating pressure, A-2
- Type, A-2

R

Rear panel, 2-7

- Analog output connector, 2-7
- Power receptacle, 2-8
- USB connections, 2-7

Rebuilding the injection valve, 5-10

Relay connections

- AS40, B-48
- Rear panel connector, 2-8, C-1

Relay outputs

- Controlling, C-5
- Voltage and current specifications, C-2

Reordering information, D-1

Reproducibility, 2-27

Reservoir

- Connecting, 3-8
- Filling, 3-7
- Monitoring liquid level in, 3-8, B-39
- Storage on top cover, 2-3

Restriction in liquid lines, 4-6, 5-7

Retention time

- Adjusting, E-1
- Moving, E-1
- Troubleshooting, 4-17

Run time, 2-15

Running samples, 3-17

- See also* Processing samples

S

Safety messages, 1-6

Sample loop, 2-5, 2-24

- Changing, 5-9
- Injecting, 2-24
- Injection valve connections, 2-24, 5-10
- Loading, 2-24

Reordering, D-1

Sample processing, 3-2, 3-17 – 3-18

- Batch, 3-2, 3-18
- Manual, 3-2, 3-17
- With Chromeleon, 3-17 – 3-18

Samples

- Collecting and storing, 3-11
- Diluting, 3-12
- Filtering, 3-11
- Injecting, 3-13 – 3-14
- Loading, 3-13
- Pretreating, 3-12

Saving data, 3-18

Schematic

- Flow, 2-9

Seal replacement, 5-14, 5-16 – 5-17

Selectivity

- Troubleshooting, 4-17

Self-Regenerating Suppressor, 2-6

- See also* Suppressor

Separation process, 1-3

Separator column, 2-5, B-22

- Installation, B-23

Sequence, 2-11

- Creating, 3-18

Sequence Wizard, 3-18

Serial number, B-18

Server Configuration program

- AS50 configuration properties, B-20
- Starting, 3-4, B-12
- Timebase, B-17

Server Monitor, B-6

Service chase, 2-3, 2-6

Service procedures, 5-12

- Check valve cleaning, 5-11 – 5-12
- Check valve replacement, 5-11
- Conductivity cell replacement, 5-20
- Fuse replacement, 5-30
- Injection valve rebuilding, 5-10
- Isolation of liquid lines restriction, 5-7
- Leak sensor replacement, 5-28
- Piston replacement, 5-17
- Piston seal replacement, 5-13
- Priming valve O-ring replacement, 5-18

- Rebuilding the injection valve, 5-10
- Replacing tubing and fittings, 5-9
- Suppressor replacement, 5-22
- Tubing and fittings replacement, 5-9
- Waste valve O-ring replacement, 5-18
- Sharable device, B-19
- Signal plot, 2-17 – 2-18
- Software license, B-5 – B-6
- Specifications
 - Column heater, A-4
 - Conductivity cell, A-3
 - Electrical, A-1
 - Environmental, A-1
 - Injection valve, A-3
 - Physical, A-1
 - Pump, A-2
 - Vacuum degas assembly, A-3
- Standards
 - When to remake, E-1
- Starting Chromeleon, B-29
- Sulfite in samples, 3-12
- Suppression description, 1-3
- Suppressor
 - Controlling the current to, 2-18
 - Description, 2-6, 2-26
 - Installation, B-24
 - Leaking, 4-10
 - Replacement procedure, 5-22
- Suppressor alarms
 - Suppressor not connected, 4-8
 - Suppressor over current, 4-7
 - Suppressor over power, 4-7 – 4-8
 - Suppressor stopped for zero flow rate, 4-8
- Syringe injection, 3-14
 - Vacuum, 3-14
- System
 - Shutdown, E-2
 - Startup, 3-3
 - Status, 3-10
- System backpressure, 2-23
- System components
 - Descriptions, 2-19
- System Control panel, 2-13, 3-5, B-55
 - See also* Control panel

- System overview, 1-4
- System properties dialog box, B-18

T

- Technical Support, 4-1, 5-1
- Temperature
 - Cell heater, 2-27
 - Column heater, 2-5, 2-26
 - Minimizing the effect of variations, 2-27
- Temperature compensation, 2-27, A-3
- Time, 2-15
- Timebase (Chromeleon), 3-5
 - Adding devices to a timebase, B-19
 - Assigning the ICS to a timebase, B-14, B-17
- TO MODULE
 - USB port connections, B-10
- Top cover, 2-3
- Troubleshooting, 4-1
 - Alarm conditions, 4-3
 - Baseline noise or drift, 4-19
 - Calibrations, 5-1
 - Diagnostics, 5-1
 - Error messages, 4-3
 - Excessive backpressure, 4-15
 - Flow rate, 4-14
 - High cell output, 4-18
 - Installation, B-57
 - Liquid leaks, 4-9
 - No cell response, 4-18
 - Peak ghosting, 4-16
 - Peak height, 4-17
 - Pump, 4-11 – 4-13
 - Retention time, 4-17
 - Selectivity, 4-17
 - Vacuum degas assembly, 4-20
- TTL and relay connector, C-1
 - Connection instructions, C-2
 - Pin assignments, C-1
- TTL inputs
 - Default function assignments, C-2
 - Rear panel connector, 2-8

TTL outputs
 Controlling, C-5
 Rear panel connector, 2-8
Tubing
 Replacing, 5-9
 Requirements, 5-9
 Routing clips, 2-8
Tubing connections
 Isolating a restriction, 4-6, 5-7
TUV, 1-8

U

Unpacking, B-2
 Computer, B-4
USB cable, B-10
USB connections, 2-7, B-9 – B-10

V

Vacuum degas assembly, 2-19
 Calibration, 5-7
 Components, 2-19
 Fails to run, 4-20
 Priming, B-41
 Specifications, A-3
 Troubleshooting, 4-11
Valve
 See Eluent valve
 See Injection valve
 See Waste valve

W

Warranty, voiding, 5-1
Waste container
 Preventing gas buildup, B-27
Waste lines
 Blocked, 4-9
 Connection, B-26
 Connection to AS50, B-46
Waste valve, 2-22

 Opening, 2-22, 5-13
 O-ring replacement procedure, 5-18
Water samples, 3-12
Weekly maintenance, 3-20
Weight, A-1
Wellness panel, 2-13, 5-1

Y

Yearly maintenance, 3-21

