



Move&Fun

User's manual

English (United Kingdom)



The crossed-out wheeled bin means that within the European Union the product must be taken to separate collection at the product end-of-life. This applies to your device but also to any enhancements marked with this symbol. Do not dispose of these products as unsorted municipal waste.

Imprint

NAVIGON AG
Schottmüllerstraße 20A
D-20251 Hamburg

The information contained herein may be changed at any time without prior notification. Neither this manual nor any parts thereof may be reproduced for any purpose whatsoever without the express written consent of NAVIGON AG, nor may they be transmitted in any form either electronically or mechanically, including photocopying and recording. All technical specifications, drawings etc. are subject to copyright law.

© 2011, NAVIGON AG

All rights reserved.

Table of contents

1	Introduction	8
1.1	About this manual	8
1.1.1	Conventions.....	8
1.1.2	Symbols.....	8
1.2	Legal notice	8
1.2.1	Liability	8
1.2.2	Trade marks	9
1.3	Questions about the product.....	9
2	Before you begin.....	9
2.1	Scope of Delivery	9
2.2	Description of the navigation device.....	10
2.3	Important safety information	10
2.3.1	Navigation safety information.....	10
2.3.2	Safety information for the navigation device.....	11
2.4	Mounting/removing the navigation system	12
2.4.1	Removing the navigation device	12
2.4.2	Mounting the navigation device.....	13
2.4.3	Memory card.....	14
2.5	Navigating with GPS.....	15
3	Switching the navigation device on and off	15
3.1	Device mounted in the vehicle	16
3.1.1	Switching on the device	16
3.1.2	Screensaver	16
3.1.3	Switching the device to standby mode	17
3.1.4	Switching off the device	17
3.2	Device not mounted.....	17
3.2.1	Switching on the device	17
3.2.2	Screensaver	18
3.2.3	Switching the device to standby mode	18
3.2.4	Switching off the device	18
3.3	Starting the navigation device for the first time.....	18
3.4	Manual	20
3.5	Options.....	20
4	Password Lock.....	20
4.1	Activating password protection	21
4.2	Changing a password	21
4.3	Cancelling password protection	21
4.4	Forgotten your password?	22
5	Operating the navigation system	22
5.1	Information	22
5.2	Software keyboard.....	26
5.2.1	Special keys	26
5.2.2	Entering data	27
5.3	Options	28

5.4	Menus	28
6	Voice Command.....	28
6.1	Activating the voice commands function	28
6.2	Use Voice Command.....	29
6.3	Help.....	29
6.4	Deactivation of the voice commands function	29
6.5	Configuring the voice commands function.....	29
7	Navigation.....	30
7.1	Starting the navigation application	31
7.2	Specifying a destination.....	32
7.2.1	Specifying the country in which the destination is situated.....	33
7.2.2	Entering a destination by voice commands	33
7.2.3	Entering a destination address.....	34
7.2.4	Enter Coordinates.....	35
7.2.5	Points of interest.....	37
7.2.6	Direct access to POI.....	40
7.2.7	Information about the destination.....	41
7.2.8	Favourites.....	41
7.2.9	Last Destinations	42
7.2.10	Imported Addresses: Outlook / Internet.....	42
7.2.11	Imported Addresses from the phone book.....	43
7.2.12	Navigating home.....	44
7.2.13	Selecting destinations on the map	44
7.2.14	Route preview.....	45
7.3	Managing destinations.....	46
7.3.1	Saving destinations.....	47
7.3.2	Deleting a destination from the Favourites list.....	47
7.3.3	Defining the home address.....	47
7.3.4	Changing the home address.....	48
7.4	Tracks and multi-leg routes.....	49
7.4.1	Entering the starting point.....	49
7.4.2	Entering route points.....	50
7.4.3	Editing route points.....	50
7.4.4	Managing routes.....	51
7.4.5	Loading routes or tracks	51
7.4.6	Calculating and displaying routes.....	52
7.4.7	Simulating routes.....	52
7.4.8	Route preview.....	53
8	Options	54
9	Working with the map.....	57
9.1	Selecting the navigation map.....	57
9.2	Map in Standard mode	57
9.3	Map in Preview mode	58

9.4	Map in Navigation mode	60
9.4.1	Navigation in Vehicle mode.....	60
9.4.2	Navigation in Pedestrian mode	65
9.4.3	Navigation in Track mode	67
9.4.4	Navigation in Offroad mode	67
9.4.5	Map options in Navigation mode.....	68
9.4.6	Quitting navigation	68
9.5	Map in Destination search mode.....	68
9.5.1	Operating in Destination search mode	69
10	Useful functions.....	70
10.1	Route profiles	70
10.1.1	Route profile settings	70
10.1.2	NAVIGON basic profiles	71
10.1.3	Creating a new route profile.....	71
10.1.4	Selecting a route profile	72
10.1.5	Managing route profiles	72
10.2	MyPOIs: My POIs	73
10.2.1	Creating your own destinations.....	74
10.2.2	Symbols for your own POIs.....	75
10.2.3	POI-Import: Importing your own POIs onto the navigation device	75
10.3	Tracks	75
10.4	Parking near the destination	77
10.5	Nearby.....	78
10.6	MyBest POI: POI on Your Route.....	79
10.6.1	Displaying POIs along the route.....	79
10.6.2	Navigating to one of the destinations	80
10.6.3	Selecting categories	81
10.7	NAVIGON Sightseeing	81
10.8	Sightseeing Tours.....	83
10.9	Direct Help.....	84
10.10	GPS Status, saving the current location.....	85
10.11	Block	85
10.12	Turn-by-Turn List	86
10.13	TMC (Traffic Information).....	88
10.13.1	Preview TMC	88
10.13.2	Displaying traffic information	90
10.13.3	Showing a single message in detail	91
10.13.4	TMC Settings.....	91
10.14	Logbook	92
11	Car Info	93
11.1	Low fuel warning.....	93
11.2	Optical parking system (OPS), Reversing assistance	94
11.3	Door monitoring	95
11.4	Trip Computer.....	96
11.4.1	Opening the trip computer	96
11.4.2	Selecting the period	97

11.5	Status	97
11.5.1	Opening the Status window	97
11.5.2	Configuring the Status window	97
12	Media	98
12.1	Controlling the car radio	98
12.1.1	Selecting the frequency band	99
12.1.2	Setting a certain frequency	99
12.1.3	Selecting a radio station	100
12.1.4	Scan: Scanning the frequency band	100
12.1.5	Preset List	100
12.2	Media Player	101
12.2.1	Supported audio files	103
12.2.2	Selecting a media source	103
12.2.3	Selecting files for playing back	104
12.2.4	Selecting the play-back mode	105
12.2.5	Controlling the play back	105
12.3	Options for the radio and media player	106
12.3.1	Traffic Information (TP)	106
12.3.2	Sound	106
12.3.3	Volume	107
12.4	Pictures	108
12.4.1	Suitable files	108
12.4.2	Opening the picture viewer	108
12.4.3	Selecting an image file	108
12.4.4	Operating the picture viewer	109
12.4.5	Selecting the play-back mode	109
12.5	Options for the picture viewer	109
12.5.1	Slideshow (Slide Show)	109
12.5.2	Background for the screensaver	110
13	Handsfree Module	111
13.1	Bluetooth Connection	113
13.1.1	Searching for and pairing Bluetooth devices	113
13.1.2	Pairing from the mobile phone	114
13.1.3	Connecting to a device	115
13.1.4	Activating a mobile phone	116
13.1.5	Deleting a device	117
13.1.6	Import Phone Book	117
13.1.7	Import recent calls	118
13.2	Taking a call	119
13.3	Receiving a text message	119
13.4	Making a call	120
13.4.1	Making a call with the voice commands function	120
13.4.2	Dialling a telephone number	121
13.4.3	Dialling a Speed Call number	121
13.4.4	Calling a contact from the phone book	121
13.4.5	Calling most recently dialled, received or missed numbers	122
13.4.6	Transferring a call from your mobile telephone	122

13.5	During a call	123
13.5.1	Moving the navigation application to the foreground	123
13.5.2	Entering numbers	123
13.5.3	Muting the microphone	123
13.5.4	Transferring a call to the mobile phone	123
13.5.5	Ending the call	124
13.6	Useful functions	124
13.6.1	Navigating to a contact from the phone book	124
13.6.2	Opening the mailbox	124
13.7	Configuring the hands-free function	125
13.7.1	Preset	125
13.7.2	Settings	125
14	Configuring the Navigation System	127
15	Appendix	128
15.1	Technical data of the navigation device	128
15.2	NAVIGON Licensing Policy	129
15.3	Declaration of Conformity	133
16	Troubleshooting.....	133
17	Index	135

1 Introduction

1.1 About this manual

1.1.1 Conventions

For better legibility and clarification, the following styles are used in this manual:

<i>Bold and italics:</i>	Names of products
SMALL CAPITALS:	Names of windows and dialogue boxes
Bold:	Highlighting of important parts in the text
<u>Underlined:</u>	Descriptions of buttons, input boxes and other elements on the user interface
<u><i>Underlined and italics:</i></u>	Names of control elements on the navigation device

1.1.2 Symbols

The following symbols refer to specific passages of text:



Instructions and tips for operating the software



More detailed information and explanations



Warnings

1.2 Legal notice

1.2.1 Liability

The software and manual are subject to change without notice. NAVIGON AG is not liable for the accuracy of the information contained in this manual or for damages resulting from the use of this manual.

Suggestions for improvements and information regarding errors are always welcome so that we can supply you with even better products in the future.

1.2.2 Trade marks

All brand and trade marks mentioned in this document and registered by third parties are subject without reservation to copyright law and the proprietary rights of their respective owners. All trade marks, trade names and company names used in this document are or may be trade marks or registered trademarks of their respective owners. All rights reserved except those explicitly granted.

If the registered trade marks used in this manual are not explicitly identified as such, this does not imply that the name is not subject to the rights of a third party.

- ▶ Microsoft, Outlook, Excel and Windows are registered trade marks of the Microsoft Corporation.
- ▶ NAVIGON is a registered trade mark of NAVIGON AG.

1.3 Questions about the product

You have a question concerning your product? Then visit our website www.navigon.com and click on "Customer Services". There you will find an area with frequently asked questions (FAQ Center) along with details of how to contact us by phone or e-mail.

2 Before you begin

2.1 Scope of Delivery



Please check that the contents are complete. If anything is missing, get in touch immediately with the dealer who sold you the product.

The purchased product includes the following:

- ▶ Navigation device
- ▶ Designer car cradle
- ▶ USB cable
- ▶ Illustrated installation instructions

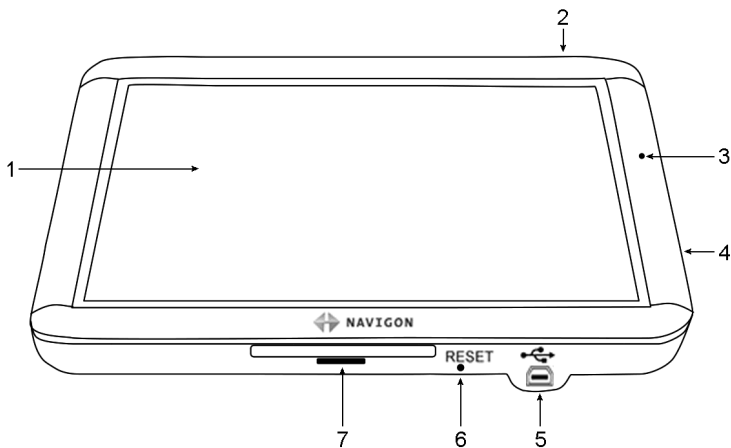
2.2 Description of the navigation device



- 1 Touch-screen
- 2  On/Off
- 3 Microphone
- 4  Slot for microSD memory card
- 5  Mini USB socket for USB cable / mains adapter
- 6 RESET Reset
- 7 LED

2.3 Important safety information

In your own interest, please read the following safety information and warnings carefully before starting up your navigation system.

2.3.1 Navigation safety information

Use the navigation system at your own risk.



Caution! To prevent accidents, do not operate the navigation system while driving.



Caution! Do not look at the screen unless it is absolutely safe to do so!



Caution! Traffic regulations have priority over any instructions from the navigation system.



Caution! Follow the instructions of the navigation system only when the circumstances and the road traffic regulations allow you to do so! The navigation system will still guide you to your destination even if you deviate from the calculated route.



Caution! When you use the navigation device in a vehicle, mount it only in the supplied cradle.



Caution! Check that the cradle is secured and adjusted properly before each journey.



Note: If you have not understood the spoken instructions or are unsure about what to do at the next junction, you can refer briefly to the map or schematic view of your navigation system.

2.3.2 Safety information for the navigation device



Caution! Protect the device from moisture. The device is neither waterproof nor protected against splash water.



Caution! Do not open the case of the navigation device under any circumstances.



Caution! Do not expose the navigation device to extreme heat or cold. This may damage the device or impair its function. (Refer to "Technical data" on page 128)



Caution! Do not subject the navigation device to severe temperature fluctuations. This can lead to condensation.



Note: Create a backup of the data which exist in the internal memory of your navigation device.

This is very easy to do with the **NAVIGON Fresh** software which can be downloaded free of charge from our website www.navigon.com/fresh.

2.4 Mounting/removing the navigation system

The vehicle is already prepared for the navigation system to be installed. In the middle of the dashboard is a slot for the cradle of the navigation device. Power is supplied to the device through this cradle. Radio traffic information is received via the antenna of the car radio. The navigation device can be used to control the car radio, and it receives vehicle data such as consumption, amount of fuel in the tank, speed, etc.

2.4.1 Removing the navigation device

When you receive your new vehicle, the navigation device is already installed. To prevent theft we recommend that you do not leave the navigation system mounted in the vehicle when you park.

Removing the navigation device from the cradle



1. Press the button at the top of the cradle (see figure).
2. Pull the bottom edge of the navigation device away from the cradle slightly.
3. Lift the device up and out.

Removing the cradle



1. Press the button at the bottom of the cradle (see figure).
2. Holding the button pressed, take the cradle out of the opening.

Fitting the cover

1. Place the cover over the opening.
2. Press the cover fully into the opening.

2.4.2 Mounting the navigation device



Caution! Be sure to refer to all the safety information in chapter "Important safety information" on page 10.

Removing the cover

In the middle of the dashboard is the opening for the cradle of the navigation device.

- ▶ Remove the cover from over the opening in the dashboard.

Fitting the cradle

1. Place the cradle, correctly aligned, over the opening provided for it.
2. Press the cradle into the opening until you hear and feel that it latches in place.

Fitting the navigation device in the cradle

On the back of the navigation device you will see a circle with two recesses.

1. Hang the navigation device by the upper recess on the upper lug of the cradle.
2. Then press it towards the cradle so that it latches in place.

Supplying power to the navigation device

The navigation device is supplied with power via the cradle. At the same time the device's battery is charged so that it can also be used outside the vehicle, e.g. for pedestrian navigation.

The LED on the bottom of the navigation device is active only when the navigation device is being charged via a charger or is connected by a USB cable to a computer. In this case its colour has the following meaning:

- ▶ **Orange:** The device is in the process of being charged.
- ▶ **Green:** The battery is fully charged.

The LED on the bottom of the navigation device lights up orange during charging.

As soon as the battery is fully charged, the LED lights up green.



Note: It takes approx. 3 hours to charge the device when the battery is flat.

A fully charged battery enables up to 3 hours of use depending on the device configuration.

Traffic Information (TMC)

The navigation device has an integrated TMC receiver. As soon as it is mounted, the device can receive traffic message updates. If required, it can change your route dynamically, e.g. in order to avoid a traffic jam.

2.4.3 Memory card

A memory card is not required to operate the navigation system because all the data needed for navigation are stored in the internal memory of the device.



Note: If you purchase additional navigation maps, they must be saved in the internal memory of the navigation device. Navigation data on the memory card are not used. The slot for memory cards is intended only for media which you can play back with the media player or the picture viewer.

When you connect the navigation system to your computer using a USB cable, the internal memory is detected as the 'NAVIGON' drive. The slot for the memory card is detected as the 'NAVIGON SD' drive.

Data backups, software updates and navigation map updates can be carried out quickly and conveniently with the **NAVIGON Fresh** software, which you can download free of charge from the website www.navigon.com/fresh.



Caution! Do not remove the memory card from the device while the data saved on it are in the process of being used, e.g. for playing back music or viewing pictures. Data may be lost as the result.



Note: A change of memory card is detected only when the device has been switched on. If the memory card is not detected, insert it again when the device is on and running.

2.5 Navigating with GPS

GPS is based on a total of at least 24 satellites orbiting the Earth and continuously transmitting signals of their position and time. The GPS receiver receives this data and calculates its own geographical position on the basis of the information transmitted by the various satellites.

Data from at least three satellites is required for positioning with an acceptable degree of accuracy. With data from four or more satellites it is possible in addition to determine the position's altitude above sea level. Positioning is accurate to within three metres.

Once the navigation device has determined your position, this position can be used as a starting point for calculating a route.

The map data on your navigation device includes the geographical coordinates of all digitally recorded points of interest, streets and places. This enables the device to calculate a route between a starting point and a destination.

Calculation of the current position and its representation on the map take place approximately once every second. In other words, your current position is always shown on the map.

3 Switching the navigation device on and off

The navigation device can be in one of four states:

- ▶ **On:** The navigation device is on and can be operated.
- ▶ **Screensaver:** The navigation device is on. However, you see only a screensaver. As long as the screensaver is visible, the device cannot be operated.

The screensaver is available only when the device is mounted in the vehicle.

If you switch on the screensaver while navigation is in progress, you will continue to hear the navigation announcements from the device.

If music is being played when the screensaver is switched on, the music will continue.

- ▶ **Standby:** When you switch the navigation device to standby mode, the next time it is switched on it will start very quickly. In standby mode the device still consumes a small amount of energy however.

Depending on how full the battery is, it can become flat within a few days or a few weeks.

- ▶ **Off:** When you switch off the device, it consumes no energy. It can then take several months for the battery to become flat. Switching the device on again triggers a restart which can take some time (approx. 60 seconds). Your settings and your saved destinations and routes will be retained.

The procedure for switching the navigation device on and off depends on whether it is mounted in the vehicle or not.

3.1 Device mounted in the vehicle

When the navigation device is mounted in the vehicle, it does not need to be switched on or off.

3.1.1 Switching on the device

The navigation device switches on when you switch on the ignition.



Note: The device also switches on when it is fitted in the vehicle while the ignition is already on.

If the navigation device was previously set to standby, the window which was last visible will appear.

If the device was previously switched off, it will take several seconds for the software to be started again. The **START** window then appears.

If you want to switch on the device with the engine off, press and hold the  (On/Off) key until the device switches on.



3.1.2 Screensaver

Switching on the screensaver

The screensaver is available only under the following conditions:

The device is mounted in the vehicle and is on.

The vehicle's ignition is on.

- ▶ Press briefly on the  (On/Off) key.
 - or –
- ▶ In the **START** window tap on  (**Switch off**).

The screensaver will appear. On it you can see the date, the time and the outdoor temperature.



Using the **NAVIGON Fresh** software you can install a function which allows you to select the picture you want to use as the screensaver. **NAVIGON Fresh** can be downloaded free of charge from the website www.navigon.com/fresh.

The date, the time and the outdoor temperature are shown likewise on the picture which you selected yourself. For more details refer to the chapter "Background for the screensaver" on page 110.

Switching off the screensaver

- ▶ Press briefly on the  (*On/Off*) key.
 - or –
- ▶ Tap anywhere on the screen.

The screensaver is phased out. The window which was active when the screensaver was switched on is visible again.



Note: The screensaver is also switched off automatically when you pull out the ignition key.

3.1.3 Switching the device to standby mode

When you pull out the ignition key, a message will appear shortly afterwards telling you that the device is being switched to standby mode.

- ▶ Tap on Standby or wait for the device to go out on its own.

3.1.4 Switching off the device

When the device is mounted in the vehicle, it does not need to be switched off. However, if you are not going to use the device for a longer period of time, you can switch it off all the same.

- ▶ Press the  (*On/Off*) key and keep it pressed until the device switches off (approx. 5 seconds).

3.2 Device not mounted

Of course you can also switch the device on and off when it is not mounted in the vehicle.

3.2.1 Switching on the device

- ▶ Press the  (*On/Off*) key and keep it pressed until the device switches on.

If the navigation device was previously set to standby, the window which was last visible will appear.

If the device was previously switched off, it will take several seconds for the software to be started again. The **START** window then appears.

Forgotten your password?



It can happen that you activate the password but are then unable to remember it.

- ▶ If you forget your password, follow the procedure described in "Forgotten your password?" on page 22.



3.2.2 Screensaver

When the navigation device is not being supplied with power from the vehicle, the screensaver is not available.

3.2.3 Switching the device to standby mode

- ▶ Press briefly on the  (*On/Off*) key.
– or –
- ▶ In the **START** window tap on  (*Switch off*).
A message will appear telling you that the device will be switched to standby mode in several seconds.
- ▶ Wait for the device to be switched to standby mode or tap on Standby.

3.2.4 Switching off the device

- ▶ Press the  (*On/Off*) key and keep it pressed until the device switches off (approx. 5 seconds).
– or –
- 1. Press briefly on the  (*On/Off*) key (max. 1 second).
A message will appear telling you that the device will be switched to standby mode in several seconds.
- 2. Tap on Switch off.

3.3 Starting the navigation device for the first time

When you switch on the navigation system for the first time, you will be asked to make the following settings:

- ▶ your preferred language for using the software
- ▶ the unit of length for distances
- ▶ the time format
- ▶ the date format
- ▶ the unit for temperature values



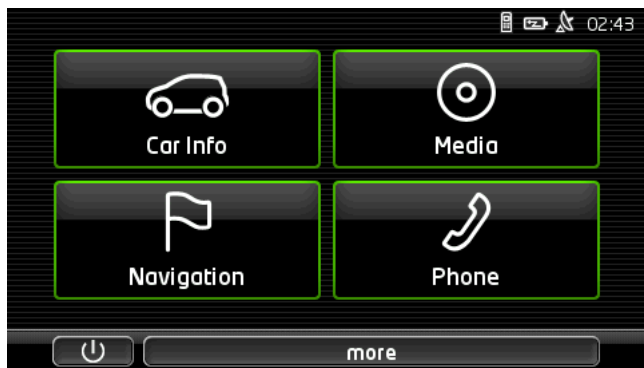

When you have entered all the required data, the following message will appear:

"Please note that the road traffic regulations are prior to the instructions of the navigation system. Please do not operate the device while driving."

- ▶ After you have read and fully understood the message, tap on **OK**. The **START** window opens.



From the **START** window you can access all the applications of the navigation device:

- ▶  [Navigation](#), see page 30
- ▶  [Car Info](#), see page 93
- ▶  [Media](#), see page 98
- ▶  [Phone](#), see page 111



Note: You can open the **START** window from practically every other window by tapping on the  (**Main menu**) button.

Note: If you have not used the navigation device for a long time, the battery may be flat.

If you are using a plug-in mains adapter or have connected your device to a PC, the device may need charging for a few minutes before it can be switched on.



When you have fitted the navigation device correctly in the vehicle, it cannot be switched on immediately. You must first wait approx. two minutes before switching it on by hand.

Chargers and other accessories are available in the NAVIGON online shop at www.navigon.com or in specialist stores.

3.4 Manual

An excerpt of this manual describing the most important functions of the navigation device is saved on the navigation device.



To open the manual:

1. In the **START** window, tap on more > Manual.

The **TABLE OF CONTENTS** window opens.

2. Tap on the name of the chapter you want to read.

The content of the chapter is shown.

With the  (Up) and  (Down) buttons you can scroll up one page and down one page respectively.

With the  (To the Left) and  (To the Right) buttons you can open the previous or the next chapter respectively.

- ▶ Tap on the Table of Contents button in order to open the Table of Contents window.
- ▶ Tap on the  (Close) button to close the manual and return to the **START** window.

3.5 Options

Some windows offer options that lead to more functions.



A description of all available options can be found in the chapter "Options" on page 54.

4 Password Lock

You can protect your navigation system from unauthorised use by creating a password. The password is always requested when the device is switched on and it is not mounted in your vehicle.

As soon as the device is mounted in a vehicle, it automatically receives the vehicle's individual ID number. The device knows therefore whether it is mounted in the "correct" vehicle. In this vehicle the password is requested only once.

4.1 Activating password protection

1. In the **NAVIGATION** window tap on Options > Settings > Options > Password Lock.
The **NEW PASSWORD** window opens.
2. Enter a password in the New password box and tap on Next.
3. Enter this password again in the Confirm new password box.
4. Tap on Activate.



Note: The password must have exactly 4 digits.

4.2 Changing a password

1. In the **NAVIGATION** window tap on Options > Settings > Options > Password Lock.
The **ENTER PASSWORD** window opens.
2. Enter the currently valid password in the Enter password box.
3. Tap on Change password.
The **NEW PASSWORD** window opens.
4. Enter a password in the New password box and tap on Next.
5. Enter this password again in the Confirm new password box.
6. Tap on Activate.



Note: The new password must have exactly 4 digits.

4.3 Cancelling password protection

1. In the **NAVIGATION** window tap on Options > Settings > Options > Password Lock.
The **ENTER PASSWORD** window opens.
2. Enter the currently valid password in the Enter password box.
3. Tap on Deactivate.

4.4 Forgotten your password?

If you enter the password wrongly three times, a window will open with instructions telling you what to do now.

- ▶ Follow the instructions on the screen.

5 Operating the navigation system

5.1 Information

The time is indicated at the top edge of many windows. When the device is mounted in the vehicle and the ignition is on you will also see the outdoor temperature.

Various information symbols are likewise located at the top of many windows.

GPS

The **GPS** symbol can show the following GPS reception status:

No GPS (No symbol): The built-in GPS receiver is not operational. Contact us if the problem persists. (Refer to "Questions about the product" on page 9)



No Signal: Data is being received from less than three satellites. Position cannot be calculated.



GPS Ready: Data is being received from at least 3 satellites. Position can be calculated.



For details of the GPS status refer to chapter "GPS Status, saving the current location" on page 85.

Track

The  (**Record Track**) symbol indicates that a track is being recorded at this moment.





For more information about tracks refer to chapter "Tracks" on page 75.

Compass

The **Compass** symbol is available only in the map view. It shows you in which direction you are currently moving. It can indicate the following points of the compass: N, NE, E, SE, S, SW, W, NW.





Showing and hiding the Compass symbol

You can activate and deactivate the **Compass** symbol so that it is shown or hidden.

- ▶ In the **NAVIGATION** window tap on Options > Settings > Navigation.
- ▶ Scroll with the  (To the Left) and  (To the Right) buttons until you see the Display Compass setting.
The currently valid setting value is highlighted (green).
- ▶ Tap on the  (Toggle) button to alternate between the setting values.
- ▶ Tap on OK.

Energy

The **Energy** symbol can indicate the following states of the integrated battery:

-  The device is mounted in the vehicle and is being supplied with power from the vehicle. The battery is fully charged.
-  The device is mounted in the vehicle and is being supplied with power from the vehicle. The battery is in the process of being charged.
-  The device is in the vehicle and is being supplied with power from the vehicle. The battery cannot be charged because its temperature is too high or too low.
-  The device is being supplied by its internal battery. The battery charge is sufficient.
-  The device is being supplied by its internal battery. The battery charge is low.

Traffic Information (TMC)

The navigation system has an integrated TMC receiver which supplies up-to-date traffic information. Using this information the navigation system can change your route dynamically, for example in order to avoid a traffic jam.





Note: This function is only available if TMC traffic messages are being transmitted in the country in which you are travelling. This is not the case in all countries.

The **TMC** symbol can display the following TMC reception status:



Tuning (in red): The TMC receiver is operational but cannot find a transmitter that is sending TCM signals. There are no active traffic messages.

 **Tuning:** The TMC receiver is operational but cannot find a station that is transmitting TMC signals. Traffic messages are active however. This can be the case, for example, when travelling through a tunnel.

 **TMC on Standby** (in grey): Traffic messages can be received.



Note: The TMC receiver uses the antenna of the car radio. The **Tuning** symbol may still appear therefore when the navigation device is not mounted in the vehicle.



For details of the TMC function refer to chapter "TMC (Traffic Information)" on page 88.

Traffic Information (TP)

The car radio can phase out the playing back of music or navigation instructions and have traffic messages announced instead when traffic information is available.

The **TP** symbol can indicate the following states:

No TP (No symbol): Traffic messages are not phased in.



TP on Standby (white): Traffic messages are phased in. When the traffic message announcement has finished, the original audio source will be used again.



Tuning (red): The radio looks for a station which transmits traffic information.

Bluetooth / Phone

The navigation device has an integrated Bluetooth hands-free module. This enables you to use the device as a hands-free kit for up to two mobile phones with Bluetooth capability.

The Phone symbol can display the following states of the hands-free module:

No Bluetooth (No symbol): The Bluetooth function is deactivated.



Not connected (red mobile phone): The navigation device has no Bluetooth connection to another device.



Connected (white mobile phone): The navigation device is connected to a mobile phone and can be used as a hands-free car kit. The number indicates which of the two phones is currently active.



Call in Progress (green mobile phone): The hands-free module of the navigation device is being used for a phone call. The number indicates which of the two phones is being used to make the call.



Headset: A headset is connected. All the instructions given by the navigation system are heard over the headset. The telephone functions of the hands-free module are not available.

Muting

The Muting symbol can indicate the following states:

No symbol: The navigation application is not muted.



Muting: The navigation application is muted. If the device is navigating at the moment, you will not hear any driving instructions.



Note: This icon indicates only the muted state of the navigation instructions. It says nothing about the volume of the hands-free module.



The procedure for regulating the volume is described in the chapter "Navigation in Vehicle mode", section "Volume", on page 64.

Logbook

The Logbook symbol can indicate the following states:

No symbol: The logbook is deactivated. There is no recording of trips.



Logbook: The logbook is activated. Before each navigation you will be prompted to enter the necessary details for the logbook entry (reason for the trip, km total, ...). It is possible however to suppress the recording of the trip.



For a description of the logbook refer to the chapter "Logbook" on page 92.

Media

When the navigation device is mounted in the vehicle and is being supplied with power from the vehicle, it can control the installed car radio. The **Media** symbol then indicates which audio source is active at the moment.

No symbol: The radio is off or the navigation device is not being supplied with power from the vehicle.



FM: The current audio source is the radio. It is set to FM reception.



AM: The current audio source is the radio. It is set to AM reception.



AUX-IN audio: The current audio source is an external device which is connected to the AUX port of the car radio.



BT-Audio: The current audio source is an external device (mobile phone or smartphone) which is connected to the navigation device via Bluetooth.



CD: The current audio source is the CD which is inserted in the car radio.



SD card: The current audio source is the MicroSD card which is inserted in the navigation device.

5.2 Software keyboard

A software keyboard appears on the screen when text entries are necessary.

All entries can be made on the software keyboard using your fingertips. Only capital letters can be entered.

When entering town or street names you need not enter any special characters or umlauts. The navigation system fills in these characters for you automatically. For example, if you are looking for the town of "Bärnau", then simply type in the word "BARNAU". Special characters may be helpful however when naming saved destinations and routes.

5.2.1 Special keys



inserts a space.



deletes the character in front of the cursor.



opens the keyboard with numerals.

Latin, Cyrillic and Greek alphabet



opens the keyboard with the Latin alphabet.

Note: The layout for the keyboard with the Latin alphabet can be configured.



- ▶ In the **NAVIGATION** window tap on [Options](#) > [Settings](#) > [General](#) > [Keypad layout \(Latin\)](#).
- ▶ Select the layout you want to use ([QWERTZ](#), [QWERTY](#), [ABCDEF](#), [AZERTY](#)).



opens the keyboard with the Cyrillic alphabet.



opens the keyboard with the Greek alphabet.

When you want to enter addresses, names or POIs, the keyboard with the alphabet for the country in question will open automatically.

When you want to save a destination to Favourites or when you enter a POI category or a country, the keyboard with the alphabet of the user interface will open automatically.

You can also switch from the Cyrillic or Greek keyboard to the Latin keyboard. Many addresses can then also be entered as transliterations or in the language of the user interface.

Example: The language of the user interface is English. You want to navigate to Moscow. You have the following options:

- ▶ "Москва" (Cyrillic)
- ▶ "Moskva" (transliterated)
- ▶ "Moscow" (English).



Note: Street names and place names can be entered only in the language of the user interface if that is how they exist in the map's database.





Note: The maximum number of keyboards available is always 2.

Umlauts, accents and other letters

Another keyboard with special characters is available for each alphabet.

 opens the keyboard with Latin special characters.

 opens the keyboard with Cyrillic special characters.

 opens the keyboard with Greek special characters.

As soon as you have entered a special character the letter keyboard reappears.

5.2.2 Entering data





Often you can select an entry from a list. This is the case, for example, when you enter a location.

As soon as you enter the first letter, the largest city in the given country that begins with this letter appears.

Enter more letters and after each entry the first city which begins with these letters will appear.

- ▶ When the correct location appears, tap on  (OK) in order to complete the entry.

You can open at any time a list containing all the locations which begin with the letters or include the text already entered. The more letters you enter, the shorter the list becomes.

- ▶ Tap on  (Open List) in order to call up this list.
You can use the  (Up) button and the  (Down) button to move through the list.
- ▶ Tap on an entry in the list to select it and transfer it to the input box.
The list closes once an entry has been selected. You are now finished with entering the city.
- ▶ Tap on  (Close List) in order to close the list without selecting an entry.



Note: The list opens automatically as soon as it contains only 4 or less entries.

5.3 Options

Some windows offer options that lead to more functions.



A description of all available options can be found in the chapter "Options" on page 54.

5.4 Menus

Some buttons have menus which open when activated.

- ▶ Tap on a menu point to execute its function.

If you would like to quit the options list without selecting a function, tap on the button you used to open the menu.

6 Voice Command



Note: The **Voice Command** function is not available in every language.

For languages in which this function is available, the Voice Command button is shown in the **NAVIGATION** window. For languages which are not supported, the Voice Command button is replaced by the Show Map button.

Many functions of your navigation device can be called up conveniently by voice command.

6.1 Activating the voice commands function

The voice commands function is automatically active in many windows. This applies in particular to windows in which you are expected to provide an answer, for example when there is a new traffic message concerning your route.

6.2 Use Voice Command

When the functions in a window can be called up by voice command, this is indicated in the top left corner of the window by the symbol



(Voice command active).

A single signal tone and the symbol  (**Speak**) indicate that the navigation system is waiting for your voice command.

- ▶ Say a command.

The positive acknowledgement tone sounds (two high-pitch tones) and the function is executed.

If the navigation system has not understood your instruction or if you do not say anything within a certain time, the negative acknowledgement tone (two short low-pitch tones) will sound.

- ▶ Say the command again.

If the navigation system has not understood you after several repetitions, the prompt "Say Help" will appear.



Note: Navigation instructions, warnings and the media player are muted for as long as the navigation device expects to receive voice commands from you.

6.3 Help

Say only "Help" if you want to know which voice commands are currently possible. In nearly all windows in which voice commands are supported the navigation system will then tell you which commands you can say in the current window.

6.4 Deactivation of the voice commands function

The voice commands function will be deactivated under the following conditions:

- ▶ If you operate the navigation device with your finger while a voice command is expected from you.
- ▶ If a call is received and during an active phone call if the navigation device is being used as a hands-free module.

6.5 Configuring the voice commands function

You can configure for which tasks you want to use voice commands.

- ▶ In the **NAVIGATION** window tap on [Options](#) > [Settings](#) > [General](#) > [Use Voice Command](#).

Select the tasks for which you want to use Voice Command:

- ▶ **Complete:** You can use all the voice command functions.
- ▶ **Answering:** You can enter addresses and answer questions asked by the navigation device.
- ▶ **Entering Addresses:** You can enter only addresses with the voice command function.



For details of how to enter a destination using voice commands refer to the chapter "Entering a destination by voice commands" on page 33.



For details of how to make a call using voice commands refer to the chapter "Making a call with the voice commands function" on page 120.

The volume of the voice controls assistant can be controlled independently of the volume of the navigation instructions. This means you can still hear the speak prompts when you have muted the navigation instructions.

1. In the **NAVIGATION** window tap on Options > Settings > General > Volume of the Assistant.
2. Select the volume for the assistant.



Note: For details of how to configure the navigation system refer to the chapter "Configuring the Navigation System" on page 127.

7 Navigation

Use the navigation system at your own risk.



Caution! Be sure to refer to all the safety information in chapter "Important safety information" on page 10.

Impaired GPS reception

If GPS reception is impaired (e.g. because you are in a tunnel), navigation will be continued. The navigation system will then calculate your likely position from the route data and your previous driving profile. As soon as GPS signals are received again, navigation will be continued with real GPS data.

Arriving at your destination

When you have reached your selected destination, a message to this effect will be displayed.

Only your current position (red arrow) and the destination flag will now be shown on the map.

7.1 Starting the navigation application

You have switched on the navigation device. The **START** window is open.

- ▶ Tap on Navigation.

The **NAVIGATION** window is opened. From here you can access all the functions of the navigation application.

Returning to the Start window

You can go to the **START** window at any time by tapping on the  (Start) button. This does not result in the current application being closed.

Initialising the GPS receiver



Note: Good reception of GPS data requires an unobstructed path from the GPS receiver to the satellites. Tunnels, narrow thoroughfares between buildings and reflecting house fronts can restrict GPS reception greatly or make it impossible. If the GPS receiver or the navigation device is inside a vehicle, a metallised windscreen or a windscreen heater can be the cause of poor GPS reception.

As soon as the navigation device has been switched on, initialisation of the GPS receiver will begin.

The integrated GPS receiver is not initialised for the first time until the navigation application is started for the first time. It can take up to 5 minutes to initialise the GPS receiver for the first time.

Each time you switch on the navigation device after this, GPS reception will start within a short time.

If the navigation device has not been switched on for more than a week, it can take up to 10 minutes to re-initialise the receiver.



Note: Directly after the GPS symbol indicates the **GPS Ready** state, the accuracy of the positioning may be reduced for a few minutes.

In the top right hand corner of the screen you will see the GPS symbol. As soon as data from at least three satellites is received, the symbol will change to  (GPS Ready).



Note: Initialisation takes the least time if you do not start driving until the initialisation has finished.



For more details about the GPS symbol refer to chapter "GPS" on page 22.

Returning to the Navigation window

The **NAVIGATION** window opens when the navigation application is started.

If another window of the navigation application is open, tap on  (**Back**). This will return you to the window you came from.

- ▶ Tap on  (**Back**) repeatedly until the **NAVIGATION** window is opened.

7.2 Specifying a destination

Under New Destination you can enter destinations to which you have not yet navigated or which you have not saved. Here you can

- ▶ enter the address of the destination. (Refer to "Entering a destination address " on page 34)
- ▶ enter the coordinates of the destination. (Refer to "Enter Coordinates" on page 35)
- ▶ select a point of interest. (Refer to "Points of interest" on page 37)
- ▶ select a destination with the Direct Access function. (Refer to "Direct access to POI" on page 40)



Note: The first time that you want to enter a new destination you will be asked to select the country in which your destination is situated.

Under My Destinations you can select from the following lists of destinations and addresses:

- ▶ **FAVOURITES:** All destinations that you have entered and then saved. (Refer to "Favourites" on page 41)
Three special destinations are also saved in the **FAVOURITES** list:
 - ▶ My Address: The address which was saved as the home address. ("Defining the home address" on page 47)
 - ▶ My Vehicle: The location of your vehicle is automatically saved when you leave the vehicle.
 - ▶ My Starting Point: The starting point of the last navigation is automatically saved.
- ▶ **LAST DESTINATIONS:** Destinations to which you have navigated on a previous occasion. (Refer to "Last Destinations" on page 42)
- ▶ **IMPORTED ADDRESSES:** All destinations that you have imported from Microsoft Outlook or from other data sources. (Refer to "Imported Addresses: Outlook / Internet" on page 42 and "Imported Addresses from the phone book" on page 43)

7.2.1 Specifying the country in which the destination is situated

At top left in the **ADDRESS**, **POI IN A CITY** and **POI NATIONWIDE** windows you will find the **Country** button. It bears the flag of the country in which you can currently select destinations for the navigation application.

If your destination is in a different country, then proceed as follows:

1. Tap on the **Country** button.
2. Enter the name of the country in which your destination is situated.
The button shows the flag of the destination country.



Note: The selection list contains only those countries whose maps are available to the navigation device.

7.2.2 Entering a destination by voice commands

It is particularly convenient to select the destination by voice commands.

1. In the **NAVIGATION** window tap on **Voice Command**.
The **VOICE COMMAND** window opens.

Entering an address

2. Say "Address".
Indicated at the top is the country for which you can select addresses.
 - ▶ Tap on the country if your destination address is situated in a different country. Then follow the instructions given by the navigation system.
You will be asked for the address data in this order: City > Street > House number.
3. Follow the instructions given by the navigation system.
When you have finished entering the address, the map will open in **Preview** mode. The destination is indicated on the map.

Entering a POI nearby

2. Say "POI Nearby".
3. Say which category of POI you want (e.g. "Hotel").
A list of nearby hotels opens.
4. Say the number of the hotel to which you want to navigate.
Say "Up" or "Down" in order to scroll in the list.
When you have selected a destination, the map opens in **Preview** mode. The destination is indicated on the map.

Entering a Favourite or an address from the phone book

2. Say "My Destinations".
3. A list opens. It contains the destinations found in the **FAVOURITES** list, destinations imported from Outlook, and destinations from the phone book of a connected mobile phone.
4. Say the number of the destination to which you want to navigate. Say "Up" or "Down" in order to scroll in the list.
When you have selected a destination, the map opens in **Preview** mode. The destination is indicated on the map.



For detailed information on how to start navigation, please refer to chapter "Route preview" on page 45. Please read on there.



Note: The **Voice Command** function is not available for every language. In the languages for which this function is not available, the **Voice Command** button is replaced by the **Show Map** button.

7.2.3 Entering a destination address

1. In the **NAVIGATION** window, tap on **New Destination** > **Enter an Address**.

Note: The following description is based on **City First** as the order for entering the address.

If the navigation device contains the map of a country in which the street is usually listed first (e.g. Sweden, Norway, ...), you can also choose **Street First** as the order for entering the destination address.

You can define the order in the **NAVIGATION** window at **Options** > **Settings** > **General** > **Input Mode for Address Data**.

Please note however that the **Street First** order of entry is not possible for all countries. In this case you must enter the city first.



The **ADDRESS** window opens.

1. Enter the name or the postal code of the destination town.
2. Enter the name of the destination street.
3. Enter the house number. If you do not know the house number, then leave this box empty.

If you don't know the house number but know the name of a nearby side street, then tap on the **Cross Street** box and enter the name of this street. The navigation system will calculate a route to the intersection of the streets you have entered.

The **DETAILED INFORMATION ABOUT THE DESTINATION** window opens.

Indicated on the **Activate MyRoutes** button is whether several route suggestions are to be calculated (**Yes**) or not (**No**).

- ▶ Tap on **Activate MyRoutes** in order to change the setting.



Note: The Activate MyRoutes button is available only when you have entered all the address information. You can also make this setting under Options > Settings > Navigation > Activate MyRoutes.

4. Tap on Start Navigation in order to navigate to the stipulated address.

- or -

Tap on Parking in order to search for and navigate to a car park near your destination.

Sometimes the destination cannot be found exactly because, for example, the entered combination of place and street name exists several times.

In this case a window will open with a list of all the addresses matching your entry plus additional information.

- ▶ Tap on the address to which you want to navigate.

If the entered house number is not included on the map, the window will show an address with the house number closest to the one entered.

The map opens in **Preview** mode. The destination is indicated on the map.



For detailed information on how to start navigation, please refer to chapter "Route preview" on page 45. Please read on there.

Note: It is not necessary to enter all the address details. You can tap on



(Start Navigation) before you get that far.



If you specify the town only, the navigation system will calculate a route to the town centre.

If you specify only the town and street without specifying a house number or cross street, the navigation system will calculate the best route to this street.

7.2.4 Enter Coordinates

You can also enter the geographic coordinates of your destination. The coordinates can be entered as decimal degrees or in degrees, minutes and seconds.

1. In the **NAVIGATION** window, tap on New Destination > Enter Coordinates.

The **ENTER COORDINATES** window opens.

Entering as a decimal number

2. Enter the degree of latitude.

Begin the entry with a minus sign if you want to enter a southern degree of latitude.

3. Enter the degree of longitude.

Begin the entry with a minus sign if you want to enter a western degree of longitude.

Entering with minutes / seconds

2. Enter the degree of latitude.

Use the corresponding buttons shown on the keyboard in order to enter the units:



(degrees),



(minutes),

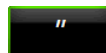

(seconds).

The (N S) button alongside the entry box indicates whether it is a northern or southern degree of latitude. The active setting is highlighted in colour (green).

- ▶ Tap on the button if you want to change the current setting.

3. Enter the degree of longitude.

Use the corresponding buttons shown on the keyboard in order to enter the units:



(degrees),



(minutes),



(seconds).

The (E W) button alongside the entry box indicates whether it is an eastern or western degree of longitude. The active setting is highlighted in colour (green).

- ▶ Tap on the button if you want to change the current setting.

The **DETAILED INFORMATION ABOUT THE DESTINATION** window opens.

Indicated on the [Activate MyRoutes](#) button is whether several route suggestions are to be calculated (**Yes**) or not (**No**).

- ▶ Tap on [Activate MyRoutes](#) in order to change the setting.

4. Tap on [Start Navigation](#) in order to navigate to the stipulated address.

- or -

Tap on [Parking](#) in order to search for and navigate to a car park near your destination.



Note: If the destination with the coordinates you entered does not lie on the road system covered by the map, navigation will be performed as far as the nearest road point using the mode defined by the selected route profile. From this point on, the navigation system will automatically switch to **Offroad** mode. (Refer to "Navigation in Offroad mode" on page 67)

7.2.5 Points of interest

Points of Interest, called POI for short, are useful addresses that are catalogued according to particular criteria.

POIs include ports, airports, restaurants, hotels, petrol stations, public buildings, doctor's surgeries, hospitals, shopping centres, etc.

Points of interest can be displayed on the map by means of a symbol. In the **NAVIGATION** window tap on [Options](#) > [Settings](#) > [Map Display](#) > [Categories Shown](#) in order to select the categories you want to appear on the map.



Note: If you have created your own POIs, they will be available under the **MyPOIs** category. For more details about creating your own POIs refer to chapter "MyPOIs: My POIs" on page 73.

POI nearby

POIs nearby are POIs located within a certain radius of your current location. This means you can always find the nearest petrol station for example, no matter where you are.

Note: GPS reception must be good enough for determining your

position. Check the  (GPS Ready) symbol to see whether GPS reception is good enough.



If GPS reception is not good enough, the system will look for POIs near the last known position. If there is no last known position, the **POI Nearby** function will not be available.

For more details refer to the chapter "Initialising the GPS receiver" on page 31.



Note: The direct access function offers 3 categories of nearby POIs which can be searched for quickly and without additional entry.

For more details refer to the chapter "Direct access to POI" on page 40.

1. In the **NAVIGATION** window tap on [New Destination](#) > [Search for POI](#) > [Nearby](#).
The **POI NEARBY** window opens.
2. Select a category from which you would like to find a POI. Categories in which no destinations are available nearby cannot be selected.
If sub-categories exist for the category you have selected, the [Sub Category](#) list opens.
3. Select the sub-category from which you would like to select a POI. The [Destination](#) list opens. It contains the nearest POIs in the specified category, sorted by distance.

4. If the list is very long:

- ▶ Tap on  (Close List).

The keyboard appears.

- ▶ Enter a number of letters from the destination.

- ▶ Tap on  (Open List).

The list now contains only those destinations which begin with the letters entered.

5. Tap on the name of the destination.

The **DETAILED INFORMATION ABOUT THE DESTINATION** window opens.

Indicated on the Activate MyRoutes button is whether several route suggestions are to be calculated (Yes) or not (No).

- ▶ Tap on Activate MyRoutes in order to change the setting.

6. Tap on Start Navigation.

- or -

Tap on Parking in order to search for and navigate to a car park near your destination.

The map opens in **Preview** mode. The destination is indicated on the map.



For detailed information on how to start navigation, please refer to chapter "Route preview" on page 45. Please read on there.

POI of nationwide significance

POIs of nationwide significance are airports, sights, national monuments, large ports etc. This way you can find well-known places of interest even if you don't know the name of their location.

1. In the **NAVIGATION** window tap on New Destination > Search for POI > Nationwide.

The **POI NATIONWIDE** window opens.

2. Select a category from which you would like to find a POI.

The Destination list opens. It contains the POI from the selected category, sorted alphabetically.

3. If the list is very long:

- ▶ Tap on  (Close List).

The keyboard appears.

- ▶ Enter a number of letters from the destination.

- ▶ Tap on  (Open List).

The list now contains only those destinations which begin with or contain the letters entered.



4. Tap on the name of the destination.
The **DETAILED INFORMATION ABOUT THE DESTINATION** window opens. Indicated on the Activate MyRoutes button is whether several route suggestions are to be calculated (Yes) or not (No).
 - ▶ Tap on Activate MyRoutes in order to change the setting.
5. Tap on Start Navigation.
- or -
Tap on Parking in order to search for and navigate to a car park near your destination.
The map opens in **Preview** mode. The destination is indicated on the map.



For detailed information on how to start navigation, please refer to chapter "Route preview" on page 45. Please read on there.

POI in a particular location

POIs in a particular location can be useful when navigating in an unfamiliar town.

1. In the **NAVIGATION** window tap on New Destination > Search for POI > in a City.
The **POI IN A CITY** window opens.
2. Enter the name or the postal code of the destination town.
3. Select a category from which you would like to find a POI. Categories in which no destinations are available in the selected town cannot be entered.
If sub-categories exist for the category you have selected, the Sub Category list opens.
4. Select the sub-category from which you would like to select a POI.
The Destination list opens. It contains POI from the specified category, sorted alphabetically.
5. If the list is very long:
 - ▶ Tap on  (Close List).
The keyboard appears.
 - ▶ Enter a number of letters from the destination.
 - ▶ Tap on  (Open List).
The list now contains only those destinations which begin with or contain the letters entered.

6. Tap on the name of the destination.

The **DETAILED INFORMATION ABOUT THE DESTINATION** window opens.

Indicated on the [Activate MyRoutes](#) button is whether several route suggestions are to be calculated (**Yes**) or not (**No**).

- ▶ Tap on [Activate MyRoutes](#) in order to change the setting.

Sometimes the destination cannot be found exactly because, for example, several restaurants with the same name exist in the town in question.

In this case a window opens with all the destinations matching your entry plus additional information.

- ▶ Tap on the destination to which you want to navigate.

7. Tap on [Start Navigation](#).

- or -

Tap on [Parking](#) in order to search for and navigate to a car park near your destination.

The map opens in **Preview** mode. The destination is indicated on the map.



For detailed information on how to start navigation, please refer to chapter "Route preview" on page 45. Please read on there.

7.2.6 Direct access to POI

The direct access area contains 3 categories of POI. Destinations in your vicinity that correspond to one of these categories can be viewed here quickly and without further entry.

- ▶ In the **NAVIGATION** window tap on [Options](#) > [Settings](#) > [General](#) in order to select which categories or sub-categories are to be available for direct access.

Note: GPS reception must be good enough for determining your

position. Check the  (GPS Ready) symbol to see whether GPS reception is good enough.



If GPS reception is not good enough, the system will look for POIs near the last known position. If there is no last known position, the **POI Nearby** function will not be available.

For more details refer to the chapter "Initialising the GPS receiver" on page 31.

1. In the **NAVIGATION** window tap on [New Destination](#).

The **NEW DESTINATION** menu opens.

In the [Direct Access](#) area you are shown the symbols of those POI categories that are available by direct access.

2. Tap on the category from which you would like to select a POI.

A list opens. It contains the nearest POIs in the specified category, sorted by distance.

3. Tap on the name of the destination in order to start navigation to it. The map opens in **Preview** mode. The destination is indicated on the map.



For detailed information on how to start navigation, please refer to chapter "Route preview" on page 45. Please read on there.

7.2.7 Information about the destination



For many destinations that you specify, there will be further information available, stored in the navigation system's database.

There is, for example, a telephone number available for many restaurants. You can then call the restaurant to reserve a table, for example.

One of the destination entry windows described above is open.

- ▶ Tap on Options > Info.

The **DESTINATION INFO** window opens. It contains all the information about the specified destination that is stored in the navigation system's database.

- ▶ Tap on Close in order to close the **DESTINATION INFO** window again.
- ▶ Tap on  (Show on Map) in order to see the destination on the map.
- ▶ Tap on  (Save Destination) in order to save the destination in the **FAVOURITES** list.

7.2.8 Favourites

Destinations to which you want to travel often can be saved in the **FAVOURITES** list.

In the **FAVOURITES** list you can save up to 500 destinations.



Information on how to save a destination can be found in chapter "Saving destinations" on page 47.

1. In the **NAVIGATION** window, tap on My Destinations > Favourites.
2. Tap on the destination to which you want to navigate. The **DETAILED INFORMATION ABOUT THE DESTINATION** window opens. Indicated on the Activate MyRoutes button is whether several route suggestions are to be calculated (Yes) or not (No).
 - ▶ Tap on Activate MyRoutes in order to change the setting.
3. Tap on Start Navigation.

- or -

Tap on Parking in order to search for and navigate to a car park near your destination.

The map opens in **Preview** mode. The destination is indicated on the map.



For detailed information on how to start navigation, please refer to chapter "Route preview" on page 45. Please read on there.



Note: Favourites are indicated on the map by a small flag with their name.

7.2.9 Last Destinations

The last 12 destinations to which you have navigated are saved by the navigation system in the **LAST DESTINATIONS** list.

1. In the **NAVIGATION** window, tap on My Destinations > Last Destinations.
2. Tap on the destination to which you want to navigate.
The **DETAILED INFORMATION ABOUT THE DESTINATION** window opens. Indicated on the Activate MyRoutes button is whether several route suggestions are to be calculated (**Yes**) or not (**No**).
 - ▶ Tap on Activate MyRoutes in order to change the setting.
3. Tap on Start Navigation.

- or -

Tap on Parking in order to search for and navigate to a car park near your destination.

The map opens in **Preview** mode. The destination is indicated on the map.



For detailed information on how to start navigation, please refer to chapter "Route preview" on page 45. Please read on there.

7.2.10 Imported Addresses: Outlook / Internet

You can use the **NAVIGON Sync** software to export to your navigation system the contact addresses which you have saved in Microsoft Outlook on your computer.

From many route planners on the Internet it is also possible to copy the entered destination address directly onto your navigation system. This function is clearly indicated on those websites which offer it.



Note: You can download **NAVIGON Sync** free of charge from our website www.navigon.com/manuals.

Contacts which have been saved with several addresses will appear once with each address in the **IMPORTED ADDRESSES** list.

1. In the **NAVIGATION** window tap on My Destinations > Imported Addresses > Outlook / Internet.
2. Tap on the address to which you want to navigate.
The **DETAILED INFORMATION ABOUT THE DESTINATION** window opens. Indicated on the Activate MyRoutes button is whether several route suggestions are to be calculated (**Yes**) or not (**No**).
 - ▶ Tap on Activate MyRoutes in order to change the setting.
3. Tap on Start Navigation.
- or -
Tap on Parking in order to search for and navigate to a car park near your destination.
The map opens in **Preview** mode. The destination is indicated on the map.



For detailed information on how to start navigation, please refer to chapter "Route preview" on page 45. Please read on there.

7.2.11 Imported Addresses from the phone book

The phone book of a mobile phone with which you are connected can be imported into the navigation device. Addresses from the phone book are then found in the **IMPORTED ADDRESSES FROM THE PHONE BOOK** list.

1. In the **NAVIGATION** window tap on My Destinations > Imported Addresses > From the phone book.
2. Select the contact you want from the phone book.
3. Tap on the address to which you want to navigate.
The **DETAILED INFORMATION ABOUT THE DESTINATION** window opens. Indicated on the Activate MyRoutes button is whether several route suggestions are to be calculated (**Yes**) or not (**No**).
 - ▶ Tap on Activate MyRoutes in order to change the setting.
4. Tap on Start Navigation.
- or -
Tap on Parking in order to search for a car park near your destination.
The map opens in **Preview** mode. The destination is indicated on the map.



For detailed information on how to start navigation, please refer to chapter "Route preview" on page 45. Please read on there.

7.2.12 Navigating home

You can save one address as Home Address. You can navigate to your home address at any time by pressing a single button.



More information about entering your home address can be found in the chapter "Defining the home address" on page 47.

- ▶ In the **NAVIGATION** window tap on Take Me Home.

If you have not yet entered your home address, a dialog box will notify you of this.

Navigation starts. The route profile used for the previous navigation will be applied.

7.2.13 Selecting destinations on the map

You may select a destination directly on the map. This is a quick way to select towns, streets and POI.

1. In the **NAVIGATION** window tap on Show Map.

- or -

If the voice commands function is available on your navigation device and for your language:

- ▶ In the **NAVIGATION** window, tap on Options > Show Map.

2. Tap on  (Destination search).

The map opens in **Destination search** mode.

3. Tap on the point to which you want to navigate.



Note: For details of how to change the map view so that your destination is easily seen refer to the chapter "Map in Destination search mode" on page 68.

The destination that you have selected appears under the cross hairs.

The geographical coordinates of the destination and the corresponding address are shown in the bottom third of the screen.

4. Tap on  (OK).

The **DESTINATION ON MAP** window opens. The detailed address data of the selected destination is displayed in the upper left-hand corner.

5. Tap on Take Me There.

The map opens in **Preview** mode. The destination is indicated on the map.



For detailed information on how to start navigation, please refer to chapter "Route preview" on page 45. Please read on there.

7.2.14 Route preview

The map is open in **Preview** mode.

The navigation destination is depicted by a small flag.



For detailed information refer to the chapter "Map in Preview mode" on page 58.

Route Profile

The route is calculated on the basis of a route profile. The current route profile is indicated at the top right edge of the map.

Route profiles take account of the characteristics and special aspects of the different modes of transport. For example a route profile for bicycles will exclude motorways from the route calculation but will include roads which other vehicles are not allowed to use. And a bicycle profile will calculate different arrival times than a motorcycle profile.



Note: If you select a pedestrian profile, a type of navigation specially developed for pedestrians will be started. (Refer to "Navigation in Pedestrian mode" on page 65)

- ▶ Tap on the [Route Profile](#) button if you want to select a different route profile.



For details of how to create and select route profiles refer to chapter "Route profiles" on page 70.

Turn-by-Turn List

- ▶ If you want to see detailed directions for the route, tap on [Options](#) > [Turn-by-Turn List](#).



For details of the functions in the **TURN-BY-TURN LIST** window refer to chapter "Turn-by-Turn List" on page 86.

MyRoutes

When the **MyRoutes** function is activated, the navigation system calculates up to three routes on the basis of the currently selected route profile and shows them on the map in different colours (green, red, blue) and with a number. For each route there is a button with the same number and a symbol in the same colour.

When calculating the time of arrival or the trip time, the navigation system takes account of additional factors such as day of the week, time of day and particularly your previous driving profile.

The route which corresponds best to the selected route profile is marked with "MyRoute".



Note: Even when the **MyRoutes** function is activated, sometimes only one additional route or no additional routes at all can be calculated for a particular route. No further suggestion is then shown on the button in question.

Start Navigation

- ▶ Tap on the button of the route which you want to use for the navigation.

If you select a route for which traffic obstructions have been announced, the **PREVIEW TMC** window may open before navigation starts. (Refer to "Preview TMC" on page 88)

- ▶ Select whether you want to use the original route (Current Route) or a detour (Alternative route).

No GPS reception

If GPS signal reception is not good enough, the following message will appear: "Waiting for GPS-Signal..."

You have the following options:

- ▶ Wait. As soon as GPS reception is good enough for determining your position, the route will be recalculated and navigation will begin.
- ▶ Tap on Cancel. The window in which you entered your destination will open again. Your destination is saved in the **LAST DESTINATIONS** list.
- ▶ Tap on Demo. The route will be calculated using the centre of the destination location as starting point. Navigation will then be simulated on this route.

Tap on  (Back) in order to terminate the demonstration.



Note: If you selected the destination on the map, then the Demo button is not available.

7.3 Managing destinations

Every destination you enter and destinations from the **LAST DESTINATIONS** and **IMPORTED ADDRESSES** lists can be saved in the **FAVOURITES** list. This makes sense if you frequently navigate to this particular destination.



Note: Favourites are indicated on the map by a small flag with their name.

7.3.1 Saving destinations

1. Enter a destination. (Refer to "Entering a destination address " on page 34 or "Points of interest" on page 37). **Do not tap on the Start Navigation button!**
2. Tap on Options > Save Destination.
- or -
1. Select a destination from the **LAST DESTINATIONS** list or from the **IMPORTED ADDRESSES** list. (Refer to "Last Destinations" on page 42 or "Imported Addresses: Outlook / Internet" on page 42). **Do not tap on the Start Navigation button!**
2. Tap on Options > Save as Favourite.
3. Enter a name for the destination.
4. Tap on Save.

7.3.2 Deleting a destination from the Favourites list

1. In the **NAVIGATION** window, tap on My Destinations > Favourites.
The **FAVOURITES** list opens.
2. Select the destination you want to delete.
The **DETAILED INFORMATION ABOUT THE DESTINATION** window opens.
3. Tap on Options > Delete Destination.

7.3.3 Defining the home address

You can always start navigation to your home address very quickly by tapping in the **NAVIGATION** window on Take Me Home.

You can define exactly one destination as your home address. You can enter the address manually or select a destination from the **FAVOURITES** list.

Your home address is saved in the **FAVOURITES** list where it is marked by a house symbol.



Note: The home address is also indicated on the map by a house symbol.



Entering the home address

1. In the **NAVIGATION** window tap on Take Me Home.
A window with the following message opens:
"Would you like to enter the address now?"



If you have already saved favourites, the message will be as follows:

"Do you want to enter the address, or do you want to select it from the Favourites?"

The currently valid value is highlighted (green).

- ▶ If Enter an Address is NOT highlighted, tap on  (Toggle).
2. Tap on OK.
The **ADDRESS** window opens.
3. Enter your home address. (Refer also to Entering a destination address on page 34)
4. Tap on  (Home Address) to save the specified address as the home address.

Selecting the home address from your favourites

1. In the **NAVIGATION** window tap on Take Me Home.
A window with the following message opens:
"Do you want to enter the address, or do you want to select it from the Favourites?"
If you have not yet saved any favourites, the message will be as follows:
"Would you like to enter the address now?"
In this case you must enter the home address manually. (Refer to "Entering the home address" on page 47)
- ▶ If Favourites is NOT highlighted, tap on  (Toggle).
2. Tap on OK.
The **FAVOURITES** list opens.
3. Select the destination which you want to define as your new home address. (Refer also to Favourites on page 41)
The **DETAILED INFORMATION ABOUT THE DESTINATION** window opens.
4. Tap on  (Home Address) to save the specified address as the home address.

7.3.4 Changing the home address

You can define a different address as the home address at any time.
Proceed as follows:

1. Delete your home address from the **FAVOURITES** list. (Refer to "Deleting a destination from the Favourites list" on page 47)

2. Enter the new home address. (Refer to "Defining the home address" on page 47)

7.4 Tracks and multi-leg routes

It is possible to plan routes without GPS reception, for example in the comfort of your home. Planned routes can be saved for later use. This allows you to plan as many routes as you like, for example for your holidays.

1. In the **NAVIGATION** window tap on Options.
The options list opens.
2. Tap on the Routes and Tracks option.
The **ROUTES AND TRACKS** window opens.

7.4.1 Entering the starting point

The starting point of a route is the point at which you want to begin your trip. This is not necessarily the current location. If you are planning a route for your holidays at home, you could, for example, enter your hotel as the starting point.

The starting point is only important if you want to see a planned route on the map but currently have no GPS reception, or if you are not currently at the planned starting point. This is why your selected starting point has the flow number "0".

As soon as you start navigation, your current location will be used as the starting point for the route calculation.

The first leg of the route is therefore the journey to the route point with flow number "1".

1. Tap on the Specify Starting Point box.
The **STARTING POINT** menu opens.

If you want to enter your current location as the starting point:

2. Tap on the Current Position menu item.

If you want to enter a different starting point:

2. Tap on the corresponding button.
3. Enter the starting point. (Refer to the corresponding section of the chapter "Specifying a destination" on page 32.)

4. Tap on  (Set Starting Point).

The selected starting point will now be shown next to the 0 (Starting Point) button.

Changing the starting point

- ▶ Tap on the starting point (button 0).

The **STARTING POINT** menu opens. You can now enter a different starting point. Proceed as described above.

7.4.2 Entering route points

The route points of a route are the destinations that you want to navigate to.

The flow number for each route point is indicated on a button in front of it.

1. Tap on the Add Route Point box.
The **ROUTE POINT** menu opens.
2. Tap on the button for how you want to enter the destination.
3. Enter the route point. (Refer to the corresponding section of the chapter "Specifying a destination" on page 32.)

4. Tap on  (Add).

The selected route point is now shown next to its flow number.

Repeat these steps for each destination that you want to add to your route.

7.4.3 Editing route points

Route points can be deleted from a route. The order of the route points can be changed as you wish.



Note: The starting point (flow number "0") can be neither moved nor deleted. However you can make another route point into the starting point provided the Current Position setting was not selected for the starting point.

- ▶ Tap on the route point that you want to edit.

The context menu contains the following buttons:



Route Point Up: Moves the selected route point further to the front. (Example: route point 2 becomes route point 1)



Route Point Down: Moves the selected route point further to the back. (Example: route point 2 becomes route point 3)



Delete: Deletes the selected route point. A dialog window prompts you to confirm deletion.

- ▶ Tap on the number to the left of the symbols if you want to close the context menu again.

7.4.4 Managing routes

You can save each planned route under a particular name.



Note: Only the start point and route points will be saved, not the calculated route. When you load a saved route, it must be recalculated before navigation can start.

You can load, rename or delete stored routes.

Saving routes

The **ROUTES AND TRACKS** window is open. You have entered the starting point and at least one route point.

1. Tap on Options > Save Route.
2. Enter a name for the route.



3. Tap on  (Save).

The destination is now saved to the **SAVED ROUTES AND TRACKS** list. The dialog window closes.

7.4.5 Loading routes or tracks

1. Tap on Options > Saved Routes and Tracks.

The **SAVED ROUTES AND TRACKS** list opens. It shows all the saved routes and tracks in alphabetical order.

A symbol in front of the name indicates whether it is a route () or a track ().

If you want to load a route:

2. Tap on the route that you want to load.
3. Tap on  (Load Route).

The **ROUTES AND TRACKS** window opens. The starting point and the route points of the loaded route have been entered. When navigation starts, the starting point is replaced by the current position. You will now be guided to the first route point.

If you want to load a track:

2. Tap on the track that you want to load.
3. Tap on Load Track.

The **ROUTES AND TRACKS** window opens. The current location is entered as the starting point. The loaded track is entered as route point 1. Navigation then leads first to the starting point of the track.



For details about navigating along recorded tracks refer to chapter "Navigation in Track mode" on page 67.

7.4.6 Calculating and displaying routes

It is possible to calculate and display a planned route on the map even without GPS reception in order to get an impression of the journey.

The **ROUTES AND TRACKS** window is open. The starting point and at least one route point have been entered.

- ▶ Tap on Show Route.

The map opens in **Preview** mode.

The starting point and the route points are marked by flags. The distance and the estimated trip time is given for each leg of the route.

7.4.7 Simulating routes

It is also possible simply to simulate navigation on a planned route.



Note: GPS reception is not necessary for simulation.

If you have planned a multi-leg route, only the first leg will be simulated.

You have calculated and displayed a route.

1. Tap on Options > Simulation.

- ▶ If you have planned a route with only one route point and the **MyRoutes** function is activated, you will be prompted to select a route for the simulation.

The route will be recalculated for simulation purposes.

2. Tap on the button of the route on which you want to simulate the navigation.



For more details about the **MyRoutes** function refer to the chapter "MyRoutes" on page 53.

Stopping simulation

You can stop simulation at any time.

- ▶ Tap on  (Back).

The **ROUTES AND TRACKS** window opens.

7.4.8 Route preview

You have calculated and displayed a route. The map is open in **Preview** mode.

Route Profile

Route profiles take account of the characteristics and special aspects of the different modes of transport. For example a route profile for bicycles will exclude motorways from the route calculation but will include roads which other vehicles are not allowed to use. And a bicycle profile will calculate different arrival times than a motorcycle profile.



Note: If you select a pedestrian profile, a type of navigation specially developed for pedestrians will be started. (Refer to "Navigation in Pedestrian mode" on page 65)

- ▶ Tap on the Route Profile button if you want to select a different route profile.



For details of how to create and select route profiles refer to chapter "Route profiles" on page 70.



Note: When you load routes which originate from a different provider than NAVIGON, it may be impossible for you to change the route profile of this route.

Turn-by-Turn List

If you want to see detailed directions for the route, tap on Options > Turn-by-Turn List.



For details of the functions in the **TURN-BY-TURN LIST** window refer to chapter "Turn-by-Turn List" on page 86.

MyRoutes

When the **MyRoutes** function is activated, the navigation system calculates up to three routes on the basis of the currently selected route profile and shows them on the map in different colours (green, red, blue) and with a number. For each route there is a button with the same number and a symbol in the same colour.

When calculating the time of arrival or the trip time, the navigation system takes account of additional factors such as day of the week, time of day and particularly your previous driving profile.

The route which corresponds best to the selected route profile is marked with "MyRoute".



Note: The **MyRoutes** function can be used only for routes with only one route point. For routes with two or more route points only one route is calculated and displayed, regardless of whether you have activated the function or not.



Note: Even when the **MyRoutes** function is activated, sometimes only one additional route or no additional routes at all can be calculated for a particular route. No further suggestion is then shown on the button in question.

Start Navigation

- ▶ Tap on the button of the route which you want to use for the navigation.

If you select a route for which traffic obstructions have been announced, the **PREVIEW TMC** window may open before navigation starts. (Refer to "Preview TMC" on page 88)

- ▶ Select whether you want to use the original route (Current Route) or a detour (Alternative route).

No GPS reception

If GPS signal reception is not good enough, the following message will appear: "Waiting for GPS-Signal..."

You have the following options:

- ▶ Wait. As soon as GPS reception is good enough for determining your position, the route will be recalculated and navigation will begin.
- ▶ Tap on Cancel. The map opens in **Preview** mode.

8 Options

Some windows offer options that lead to more functions.

- ▶ Tap on Options.
- ▶ Tap on the option you would like to use.
- ▶ If you would like to quit the options list without selecting an option, tap on the Options button again.

2D/3D: Changes between 2D and 3D mode. The symbol indicates the current mode.

Add to Route: Opens the route planning. The address specified will be added as a route point. (Refer to "Tracks and multi-leg routes" on page 49)

Block: Opens a window in which you can block a section of the route lying ahead in order to calculate a route which avoids this section, e.g. if you have heard on the radio of a traffic jam relating to this section. (Refer to "Block" on page 85)

Day/Night: Changes between "Day" and "Night" screen modes. The symbol indicates the current mode.

Delete All: Deletes all destinations in the list (**LAST DESTINATIONS** list or **FAVOURITES** list, depending on where you opened the options). The list is then empty. A dialog window prompts you to confirm deletion.

Delete Destination: Deletes the selected destination from the list (**LAST DESTINATIONS** or **FAVOURITES**, depending on where you opened the options). A dialog window prompts you to confirm deletion.

Direct Help: Opens a window in which you can find in quick and uncomplicated manner the addresses and phone numbers of offices in your direct vicinity that can be useful in emergencies. (Refer to "Direct Help" on page 84)

Factory Settings: Resets all settings to the as-delivered state. Routes and saved destinations are deleted. The software is re-started and behaves as if started for the first time after being purchased. (Refer to "Switching the navigation device on and off" on page 15)

GPS Status: Opens the **GPS STATUS** window. Here you can see details regarding GPS reception. You can also save the data of your current location. (Refer to "GPS Status, saving the current location" on page 85)

Home Address: Saves the selected destination as your home address. You can then always start navigation to this destination very quickly by tapping in the **NAVIGATION** window on **Take Me Home**.

Interim Destination: Sets the selected point as interim destination. The navigation system will first guide you to this interim destination. Afterwards you can continue navigation to your original destination.

Manual: Opens the manual on the navigation device. (Refer to "Manual" on page 20)

MyReport: Opens the **MYREPORT** window. Here you can notify NAVIGON about any changes to traffic monitoring systems and routing.

MyRoutes: Opens the map in **Preview** mode. You are provided with up to three different suggestions as to how you can continue your journey. Select one of the routes offered.

New Route: Deletes the starting point and all route points from the **ROUTES AND TRACKS** window so that you can plan a new route. If necessary, save the previously planned route!

Parking: Starts the search for car parks near the destination. Once you have decided in favour of a car park, you can navigate there directly.

POI on Your Route: Opens a list with POIs lying on your route. A destination shown here can be selected as an interim destination and can be navigated to. (Refer to "MyBest POI: POI on Your Route" on page 79)

Product Information: Here you are shown the version numbers and copyright details of the hardware and software.

Rename: Opens a window in which you can change the name for the selected destination or route.

Route Profile: Opens the **ROUTE PROFILE** window. Here you can view the options for route planning and, if necessary, change them.

Routes and Tracks: Opens the **ROUTES AND TRACKS** window. Here you can plan routes, manage planned routes and start navigation on a planned route. (Refer to "Tracks and multi-leg routes" on page 49)

Save as Favourite: Saves the selected destination to the **FAVOURITES** list. (Refer to "Saving destinations" on page 47)

Save Destination: Saves the selected address in the **FAVOURITES** list. (Refer to "Saving destinations" on page 47)

Save Position: Opens the **SAVE DESTINATION AS** window. Here you can save your current position under a certain name in the **FAVOURITES** list.

Save Route: Opens a window in which you can save the planned route under a specific name. (Refer to "Saving routes" on page 51)

Saved Routes and Tracks: Opens a window in which you can load a saved route or a track.

Settings: Opens the **SETTINGS** window. Here you can configure the navigation system. (Refer to "Configuring the Navigation System" on page 127)

Show Map: Opens the map in **Standard** mode. (Refer to "Map in Standard mode" on page 57)

Show on Map: Shows the selected address on the map.

Sightseeing Tours: Opens the **SIGHTSEEING TOURS** window. There you can select a sightseeing tour and start the navigation on a tour. (Refer to "Sightseeing Tours" on page 83)

Simulation: Simulates a navigation on the route indicated. This simulation can be performed without GPS reception. On multi-leg routes, only the first leg is simulated.

Skip current destination: Tap on this button to omit the next route point. This button is active only when at least 2 route points still lie ahead of you. (Refer to "Tracks and multi-leg routes" on page 49)

Start Recording, Stop Recording: Starts or ends the recording of a track. (Refer to "Tracks" on page 75)

Traffic: Opens the **TRAFFIC INFORMATION** window in which pending reports are listed. (Refer to "TMC (Traffic Information)" on page 88)

Turn-by-Turn List: Shows detailed directions for the route, including all points at which you must turn. (Refer to "Turn-by-Turn List" on page 86)

9 Working with the map

9.1 Selecting the navigation map

Each country has its own navigation map. Seamless navigation over several maps on one continent is possible however if a continuous route can be calculated with the maps saved on the device.

Even if maps of countries in other continents are available on the navigation device, it can only ever work with the maps of a single continent.

Tap in the **NAVIGATION** window on Options > Settings > Map Display in order to see which maps are currently in use. Here you can also select a different continent if the navigation device contains any maps of countries on other continents.

9.2 Map in Standard mode

The map is always in **Standard** mode when you are not navigating, have not calculated a route and are not searching for a destination on the map.

Under the following circumstances the map switches automatically to **Standard** mode:

- ▶ You begin a trip while the **NAVIGATION** window is open. The switch takes place after only a short while.

- ▶ You reach the destination of a navigation in **Vehicle** mode.
To open the map:
- ▶ In the **NAVIGATION** window tap on Show Map.



Note: If GPS reception is not good enough to establish your location, the map will be opened in **Destination search** mode.



The following features are typical for this view:

- ▶ Indicated in the middle of the lower third is your current position (red arrow). The map view follows your movements so that your position is always visible on the screen.
- ▶ The scale of the map changes according to your speed.

Map options in Standard mode

- ▶ Tap on Options.
A window with several buttons opens.

The most important functions for navigation can be reached via buttons with symbols.

Other functions are found by tapping on one of the buttons Destination, Route, Services or General.



A description of all available options can be found in the chapter "Options" on page 54.

9.3 Map in Preview mode

You have entered a destination and tapped on Start Navigation.

- or -

You have planned or loaded a route and tapped on Show Route.

The map opens in **Preview mode**.

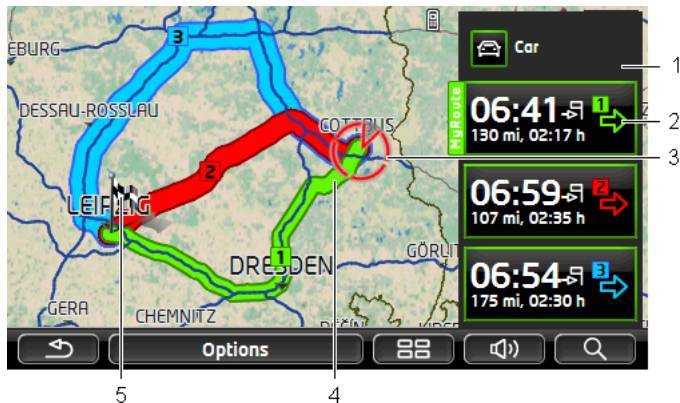

- 1 The current route profile is indicated on the  (Route Profile) button. The symbol illustrates the mode of transport on which the profile is based. (Refer to "Route profiles" on page 70)
 - ▶ Tap on the symbol to select a different route profile.
- 2 For each route (green, red, blue) there is a button with the same number and a symbol in the same colour. Indicated on each button are the estimated time of arrival, the total distance and the estimated duration of the particular route.

If traffic messages exist for a route, the number of messages is indicated in a small traffic sign on the button. The reported obstructions are also indicated on the route.



The route which corresponds best to the selected route profile is marked with "MyRoute".

If the **MyRoutes** function is not activated, only one route is presented. As soon as you tap on a button, navigation along the route in question will start.
- 3 The current position is indicated (red arrow).

If you display a planned or loaded route and the specified starting point is not your current location, then it is possible that your current position will not be shown on the preview.
- 4 When the **MyRoutes** function is activated, up to three numbered routes are indicated on the map in different colours (green, red, blue).

In the following cases only one route is shown:

 - ▶ The **MyRoutes** function is deactivated.
 - ▶ You have planned a route with more than one route point.
 - ▶ A route profile with the Pedestrian speed profile is active.

- 5
 - ▶ The route includes a track.
 - The destination is marked with a little flag.
 - If you display a planned or loaded route, the starting point and each route point will be marked with a little flag.
 - In the case of a multi-leg route, the distance and the estimated driving time for each leg are shown.
 - ▶ Tap on the  (**Route Profile**) button (refer to the figure, point 1) in order to select a different route profile.
 - ▶ To start the navigation, tap on the button for the route (see figure, point 2) you want to use for the navigation.
If you display a planned or loaded route, the route may be recalculated. The starting point for the calculation will now be your current location. You will first be guided to the first route point entered.
 - ▶ Tap on **Options** > **Turn-by-Turn List** to view detailed directions for the route. (Refer to "Turn-by-Turn List" on page 86)
 - ▶ Tap on  (**Destination search**) in order to view the map in **Destination search** mode. (Refer to "Map in Destination search mode" on page 68)

9.4 Map in Navigation mode

How you are guided to your destination depends on various factors (the route profile selected, your current location, the type of route planning, traffic information along the route, etc.). Your navigation system automatically selects the optimum method.

9.4.1 Navigation in Vehicle mode

After the route was shown in **Preview** mode, navigation was started.

The map opens in **Navigation mode**.



- 1 If any information is available about the sign which you should follow, it will be shown at the top edge of the screen.
 - ▶ Tap on the display to hide the sign.
- 2 The **POI on Your Route** bar will open (refer to "POI on Your Route" on page 79). This button is not visible when a sign is being shown (see point 1).



For a description of the **POI on Your Route** function refer to chapter "POI on Your Route" on page 79.

- 3 Possible speed limits may be shown here.
- 4 When two manoeuvres need to be executed in quick succession, the small arrow box indicates the second manoeuvre to be executed.
- 5 Your current position is indicated on the map (red arrow). The section of the map displayed changes continually so that your current position is always in view on the map.
- 6 The large arrow box shows a diagram of the next junction which you should turn on to. The distance remaining to this junction is indicated underneath.

As you get closer to the junction you will see a bar in addition to the distance:

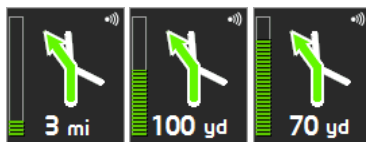

The fuller the bar, the closer you are to the junction.

If you don't have to change direction for a long time, you will see only a straight arrow. The distance you must continue straight on is indicated underneath the arrow.

▶ Tap on the large arrow box to hear current route instructions.

7 The **Traffic Information** box opens if a reported traffic obstruction affects your route.

If a distance is indicated in the **Traffic Information** box, no detour route was calculated yet for the traffic obstruction in question.

▶ Tap on the **Traffic Information** box in order to open the **PREVIEW TMC** window. It shows a map view with the route section affected by the message and a possible detour.

If no distance is indicated, all the obstructions which are reported for your route and would lead to a loss of time will be avoided.

▶ Tap on the **Traffic Information** box in order to open the **TRAFFIC INFORMATION** window. (Refer to "Displaying traffic information" on page 90)



Note: The calculation of detour routes to avoid reported traffic obstructions can be performed automatically. (Refer to "TMC Settings" on page 91)

8 When you get close to your destination, the Parking button will appear.

If you tap on the Parking box you will be given two options:

- ▶ You can select a car park from where you can then continue on foot.
- ▶ When you have parked your vehicle, you can save the current position and continue the navigation on foot.



For a description of the Parking function refer to chapter "Parking near the destination" on page 77.

9 When you get close to a **NAVIGON Sightseeing** sight, the NAVIGON Sightseeing button will appear instead of the height above sea level and the speed (point 10). The distance indicated on the button tells you how far away the sight is (beeline).

If you tap on the [NAVIGON Sightseeing](#) button, the **DESTINATION INFO** window will open (refer to "Displaying information about a NAVIGON Sightseeing sight" on page 82).



For a description of the [NAVIGON Sightseeing](#) function refer to chapter "NAVIGON Sightseeing" on page 81.

- 10 The height above sea level and the current speed are shown here.
- 11 The route is highlighted in green.
- 12 In the **Total** box you can see the distance remaining to the destination, the estimated duration of the trip and the estimated time of arrival.
 - ▶ Tap on the arrival time if you want to see the estimated driving time instead.
 - ▶ Tap once again on the info box if you want to see the estimated time of arrival.
- 13 If you are navigating a multi-leg route, you will see the remaining distance to the next interim destination and the estimated time of arrival in the **Next** box.
 - ▶ Tap on the arrival time if you want to see the estimated driving time instead.
 - ▶ Tap once again on the info box if you want to see the estimated time of arrival.
- 14 The name of the route section that you need to drive onto next is shown in the upper road box.
- 15 The name of the section you are currently driving on is shown in the lower road box.
- 16 Ahead of many junctions the information from points 10 and 12 is hidden. Instead you are shown which lanes lead to your destination.
 - ▶ Tap on the box in order to hide the lane information.



Note: The displays of many of the above mentioned areas can be configured in [Options](#) > [Settings](#) > [Navigation](#). Some displays will only function if the required information is available on the map.



Note: If you tap on the large arrow box, the current route instruction will be repeated.



Note: If you leave the road system covered by the map, the navigation will switch to **Offroad** mode. (Refer to "Navigation in Offroad mode" on page 67)

- ▶ Tap on [Options](#) > [Route](#) > [Turn-by-Turn List](#) in order to view a turn-by-turn list. (Refer to "Turn-by-Turn List" on page 86)

- ▶ Tap on  (**Destination search**) in order to view the map in **Destination search** mode. (Refer to "Map in Destination search mode" on page 68)

Volume

The volume of the spoken driving instructions can be adjusted during navigation.

When the device is mounted in the vehicle:

- ▶ You can regulate the volume on the radio when a navigation instruction is being announced.

Tap on the large arrow box (see point 6 in the figure at the beginning of this chapter). A current instruction will then be announced.

When the device is not mounted in the vehicle:

1. Tap on  (**Volume**).

The volume bar opens. It contains three buttons for adjusting the volume.

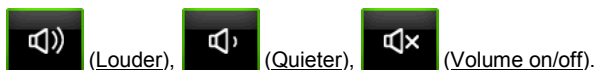

2. Tap on  (**Volume**) again or wait a few seconds.
The volume bar closes.

Reality View

The map switches to **Reality View** mode when you approach one of the following points while driving on the motorway:

- ▶ a motorway junction
- ▶ a three-leg motorway junction
- ▶ the exit you must take to leave the motorway



The **Reality View** mode shows with greater clarity the signposting and lanes you must follow.

This display does not change until you have passed the spot indicated. The map will then change back to **Navigation** mode.

- ▶ If you want to change to **Navigation** mode before then, just tap on any point on the map.



Note: The **Reality View** mode is not available for all motorway junctions and three-leg motorway junctions. Availability depends on the map material used.

9.4.2 Navigation in Pedestrian mode

This mode is active if you have selected a pedestrian route profile for the navigation. These profiles can be identified by the  (**Pedestrian**) symbol.

After the route was shown in **Preview** mode, navigation was started.

You receive a route proposal which is calculated on the basis of the digitalised road system. You are also shown in which direction your destination lies. If you leave the proposed route, for example in order to take a more pleasant route through a park, you will still see at all times the direction in which your destination lies.

Please note:

- ▶ You will receive no navigation instructions. Instead you will receive a message when you are getting close to the destination.
- ▶ The map view follows your movements so that your position is always visible on the screen.
- ▶ If you leave the calculated route, the route will not be recalculated automatically.

- ▶ If you are navigating on a route and more route points are still to follow, navigation to the next route point will be started immediately after the message.
- ▶ Traffic messages are not taken into account.



Note: In pedestrian mode you must take care to hold the device without covering it at the top. The GPS receiver is located there and its reception could be impaired..

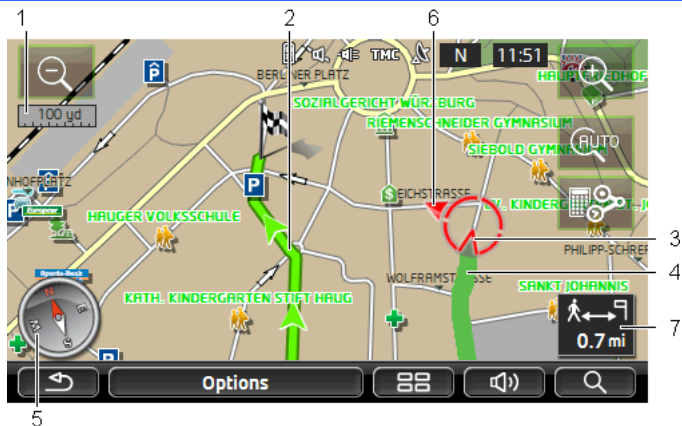

- 1 The scale of the map section shown is indicated here. The length of the ruler corresponds to the distance indicated.
- 2 The route which was calculated using the digitalised road system is marked in green.
- 3 The current position is indicated (red arrow). You can see in which direction you are moving.
- 4 The part of the route which you have already covered is marked in green.
- 5 The compass indicates where north is.
- 6 The direction in which your destination lies is indicated (red triangle).
- 7 In this box you are shown the distance remaining to the destination (beeline).

Operating the map



Zoom Out: The map section shown becomes larger, but you will see fewer details.



Zoom In: The map section becomes smaller, but you will see more details.



Centre the position: During pedestrian navigation you can shift the visible map section in order to view the surrounding area on the map. This may mean that your current position can no longer be seen on the visible section of the map.

- ▶ Tap on the **Centre the position** button if your current position can no longer be seen on the visible section of the map.

Your current position will be shown again on the map.



Recalculate route: Recalculates the route. Use this function if you have wandered far from the calculated route and would like a new route proposal.

9.4.3 Navigation in Track mode

This mode becomes active if you have planned a route with a track for the navigation. (Refer to "Tracks and multi-leg routes" on page 49)

After the route was shown in **Preview** mode, navigation was started.

First the navigation guides you from your current location to the beginning of the loaded track. This navigation corresponds to the navigation of the selected route profile. (Refer to "Navigation in Vehicle mode" on page 60 and "Navigation in Pedestrian mode" on page 65)

As soon as the first recorded point of the track is reached, the navigation switches to **Track** mode.

Navigation in **Track** mode works like navigation in **Pedestrian** mode. (Refer to "Navigation in Pedestrian mode" on page 65)

There are only a few differences:

- ▶ The **Recalculate route** function is not available.
- ▶ If more route points follow after the track, the navigation will switch back to the originally selected mode.

9.4.4 Navigation in Offroad mode



Note: This mode does not become active if you have selected a pedestrian route profile for the navigation. These profiles can be

identified by the  (**Pedestrian**) symbol.

Nor does it become active if you are navigating along a track. (Refer to "Navigation in Track mode" on page 67)

If you enter a destination which lies off the digitalised road system, the navigation will guide you first in **Vehicle** mode to the point of the digitalised road system that lies nearest to the destination. From here the navigation then continues in **Offroad** mode.

If the current position at the beginning of navigation lies off the digitalised road system, the navigation will guide you first in **Offroad** mode to the nearest point of the digitalised road system. From here the navigation then continues in **Vehicle** mode.

Navigation in **Offroad** mode works like navigation in **Pedestrian** mode. (Refer to "Navigation in Pedestrian mode" on page 65)

There are only a few differences:

- ▶ The part of the route already covered is not shown.
- ▶ The Recalculate route function is not available.

9.4.5 Map options in Navigation mode

- ▶ Tap on Options.

A window with several buttons opens.

The most important functions for navigation can be reached via buttons with symbols.

Other functions are found by tapping on one of the buttons Destination, Route, Services or General.



A description of all available options can be found in the chapter "Options" on page 54.

9.4.6 Quitting navigation

You quit the navigation in the same way in all modes:

- ▶ Tap on  (**Back**) in order to quit navigation. A dialog box will prompt you to confirm.

9.5 Map in Destination search mode

The map is always in **Destination search** mode, when a pair of cross hairs are to be seen. Indicated in the address box are the coordinates and, where applicable, the name of the street under the cross hairs.

When you are driving, the map does not change. It is always orientated with north at the top.



Zoom Out: The map section shown becomes larger, but you will see fewer details.



Zoom In: The map section becomes smaller, but you will see more details.



Zoom Mode: When this button is active you can mark out a section of the map with your finger.

Mark out the section from upper left to bottom right to zoom in until the section fills the screen.

Mark out the map section from bottom right to top left to zoom out.



Pan Mode: When this button is active you can change the section of map shown with your finger. Simply drag the map in the desired direction.



Entire Route: Zooms the map so that the entire route is visible.



Current Position: Selects the section of map displayed so that the current location is at the centre.

9.5.1 Operating in Destination search mode

1. Tap on the point to which you want to navigate.
The destination that you have selected appears under the cross hairs.
The geographical coordinates of the destination and the corresponding address are shown in the bottom third of the screen.

2. Tap on  (OK).

Buttons with various functions will be displayed.

Take Me There: Starts navigation to the selected point. If you are currently navigating, this route navigation will be cancelled.

MyReport: Opens the **MYREPORT** window. Here you can notify NAVIGON about any changes to traffic monitoring systems and routing.

Interim Destination: Sets the selected point as interim destination. The navigation system will first guide you to this interim destination. Afterwards you can continue navigation to your original destination. This function is only active during navigation.

Add to Route: Adds the selected point to the route planning as the last point. Navigation will then continue to this point after you have reached the original destination or the other route points.

Save: Opens the **SAVE DESTINATION AS** window. You can enter a name under which the selected point will be saved in the **FAVOURITES** list. (Refer to "Saving destinations" on page 47)

Search Nearby: Opens the **POI NEARBY** window. Here you can search for destinations near the selected point. (Refer to "POI nearby" on page 37)

- ▶ Tap on  (Back) in order to quit **Destination search** mode. You will be returned to the window from which you started this mode.

10 Useful functions

10.1 Route profiles

Route profiles define the characteristics and special aspects of the different modes of transport which are to be taken into account when calculating routes. For example a route profile for bicycles will exclude motorways from the route calculation but will include roads which other vehicles are not allowed to use. And different arrival times will be calculated for a bicycle than for a motorcycle for example.

10.1.1 Route profile settings

A route profile is made up of several settings:

- ▶ **Speed Profile:** Defines the mode of transport (e.g. Bicycle, Pedestrian, Car, ...).
- ▶ **Type of Route:** Defines the type of route which is to be calculated (e.g. Short Route, Fast Route, ...).

- ▶ Consider Traffic Information: Defines whether traffic messages are to be considered when calculating the route.
- ▶ Motorways, Ferries, Restricted Areas: Defines whether these types of road are allowed to be used.
- ▶ Use of Toll Roads: Defines whether toll roads are allowed to be used when calculating the route.
 - ▶ Tap on the  (Edit) button.
The **USE OF TOLL ROADS** window opens.
 - ▶ Adapt the individual settings to your requirements (Yes, No, Ask before). (Refer also to "Configuring the Navigation System" on page 127)
If you activate the Ask before setting, every time your route can take a toll road you will be prompted to make the corresponding setting(s).

For each setting there is a  (Help) button. When you tap on it you will see an exact definition of the setting in question.

The number of possible settings depends on the selected speed profile. For example, for the Pedestrian speed profile there are no Motorways and Use of Toll Roads settings.

10.1.2 NAVIGON basic profiles

A basic profile is already defined for each speed profile.



Bicycle



Pedestrian



Lorry



Motorbike



Car

The speed profile of a basic profile cannot be changed. You can adapt the other settings to your requirements.

Basic profiles cannot be renamed or deleted.



To have a choice of different profiles for example for several cars, you can create your own route profiles.

10.1.3 Creating a new route profile

You can create your own route profiles. This makes sense for example if you own two cars and only one has a prepaid toll disc for Austrian motorways.

1. Tap on Options > Settings.
If the map is open in **Standard** mode, tap on Options > General > Settings.
2. Tap on the  (Current Route Profile) button. This button can also show a different symbol.
3. Tap on the name of the route profile which you want to take as basis for the new profile.
4. Tap on Options > Copy.
5. Enter a name for the route profile.
6. Tap on Save.
7. Adapt the route profile to your requirements.
8. Tap on OK.
The new route profile is shown in the **ROUTE PROFILES** list.



10.1.4 Selecting a route profile

1. Tap on Options > Settings >  (Current Route Profile).
If the map is open in **Standard** mode, tap on Options > Route > Current Route Profile.
2. Tap on the name of the route profile which you want to use.
3. Tap on  (Back).

10.1.5 Managing route profiles

User-defined route profiles can be edited, renamed and deleted.

Editing a route profile

1. Tap on Options > Settings.
If the map is open in **Standard** mode, tap on Options > General > Settings.
2. Tap on the  (Current Route Profile) button. This button can also show a different symbol.
3. Tap on the  (Edit) button alongside the route profile that you want to edit.
4. Make the required settings.
5. Tap on OK.

The Use of Toll Roads setting is comprised of several individual settings. For example for each country with toll motorways you can select whether you want to use these roads for the navigation.

1. Tap on the  (Edit) button alongside the Use of Toll Roads setting.
The **USE OF TOLL ROADS** window opens.
2. Adapt the individual settings to your requirements (Yes, No, Ask before).
If you activate the Ask before setting, each time the route preview wants to calculate a route with a toll road you will be asked whether you want to use the type of toll roads in question. You can then lay down this setting for future journeys as well.

Renaming a route profile

1. Tap on Options > Settings.
If the map is open in **Standard** mode, tap on Options > General > Settings.
2. Tap on the  (Current Route Profile) button. This button can also show a different symbol.
3. Tap on the name of the route profile which you want to rename.
4. Tap on Options > Rename.
5. Enter the new name for the route profile.
6. Tap on Save.



Note: Basic profiles cannot be renamed.

Deleting a route profile

1. Tap on Options > Settings.
If the map is open in **Standard** mode, tap on Options > General > Settings.
2. Tap on the  (Current Route Profile) button. This button can also show a different symbol.
3. Tap on the name of the route profile which you want to delete.
4. Tap on Options > Delete.
5. A dialog window prompts you to confirm deletion.
6. Tap on Yes.



Note: Basic profiles cannot be deleted.

10.2 MyPOIs: My POIs

You can create files with your own POIs. These files have to be made available to your navigation system in a specific folder.

If you want to choose from your own POIs, you will find them under the **MyPOIs** category of POIs. Each file with your own POIs is listed as a sub-category. Each sub-category can have a personally created symbol for representing your destinations on the map.

The navigation device can import a maximum of 10,000 POIs. These destinations are allowed to be shared among a maximum of 40 sub-categories.

10.2.1 Creating your own destinations

1. Open an empty document in an editor which can save the files in UTF8 code (e.g. MS Notepad, Microsoft Word).



Note: The following description is based on the use of MS Notepad as editor. If a different editor is used, the saving of the file and its UTF-8 coding (point 4-9) may differ from this description.

2. For each destination create a data record (one line) with the following form:
 - ▶ Longitude. Begin the entry with a minus sign if you want to enter a western degree of longitude. The longitude must be entered as a decimal number with a dot as the decimal sign.
 - ▶ Comma (as list separator)
 - ▶ Latitude. Begin the entry with a minus sign if you want to enter a southern degree of latitude. The latitude must be entered as a decimal number with a dot as the decimal sign.
 - ▶ Comma (as list separator)
 - ▶ Name of the destination. Any name is possible, but no commas are allowed. If the use of a comma is indispensable, precede it with a backslash ('\').
 - ▶ Comma (as list separator)
 - ▶ PHONENUMBER=
 - ▶ A phone number. This entry can remain empty.
 - ▶ Tilde ('~')
 - ▶ Additional information. This entry can remain empty.
 - ▶ Enter (in order to begin a new data record)

The address does not have to be included in the data record. It is shown automatically when you select this POI for navigation.

Example:

9.94302,49.79906,NAVIGON AG,PHONENUMBER=+49 931~Best Navigation Devices

3. Repeat step 2 for each destination you want to save in this file.
4. Click on File > Save.

5. Select a folder in which you want to save the data.
6. In the File type box select the All Files option.
7. In the file name box enter a name of your choice followed by '.csv', e.g. 'XYZ.csv'. Please note that the file name will appear in the navigation system as a sub-category! This means that if you save a file under the name 'XYZ.csv', the destinations of this file will appear in the sub-category **XYZ**.
8. In the Encoding box select the UTF-8 option.
9. Tap on Save.

10.2.2 Symbols for your own POIs

For each sub-category of your own POIs you can create a symbol which is used to represent the destinations of this sub-category on the map.

These symbols must be graphic files with the following characteristics:

- ▶ File format **bmp** (Bitmap) or **png** (Portable Network Graphic)
- ▶ Size max. 40x25 pixels

The graphic files must be saved in the same folder as the files with the POIs.

The file name must be the same as the name of the category.

Example:

Destinations of the **XYZ** sub-category are saved in the 'XYZ.csv' file. They are represented on the map by the 'XYZ.bmp' symbol.

10.2.3 POI-Import: Importing your own POIs onto the navigation device

The files you have created with your own POIs and the related symbols must still be transferred to the navigation device. This is very easy to do with the **NAVIGON Fresh** software which can be downloaded free of charge from our website www.navigon.com/fresh.

10.3 Tracks

You can record any section of a route you take, even if it lies off the digitalised road system.

You can record for example a bicycle tour and follow the same route again some time later.

Tracks are saved in KML data format. KML is a widely used data format. You can also play back your tracks for example in Google Earth on your PC.

Recording a track

You can record a track when the map is open in **Navigation** mode or in **Standard** mode.

1. Tap on [Options](#) > [Services](#) > [Start Recording](#).
The **START RECORDING** window opens.
 2. Enter a name for the planned recording.
-



Note: Only Latin characters are available for naming tracks.

3. Tap on [Start Recording](#).
Starting from your current position, the navigation device will record the entire route you now take.
The  (**Record Track**) symbol appears at the top edge of the screen throughout the recording.
The recorded route is saved in the **SAVED ROUTES AND TRACKS** list in KML data format. It can be loaded again from there at any time.

Stopping the recording

1. Tap on [Options](#) > [Services](#) > [Stop Recording](#).
The recording is stopped. The recorded route is saved in the **SAVED ROUTES AND TRACKS** list in KML data format. It can be loaded again from there at any time.
-



Note: Switching off the navigation device will only interrupt the track recording. If you want to stop the recording, you must proceed as described above.

Using a track for navigation

You can load saved tracks as part of planning a route. (Refer to "Loading routes or tracks" on page 51)



Note: All tracks that have been saved in KML data format are suitable for route planning. Use **NAVIGON Fresh** in order to load tracks from other suppliers onto your navigation system.



Note: When you are navigating along a recorded track, any incoming TMC messages will not be checked to see if they concern the track in question.

10.4 Parking near the destination

When you get close to your destination, the  (Parking) button will appear on the screen. This button also remains visible after you have reached your destination as long as you stay close to the destination and the map is not closed.

The following scenarios are imaginable:

Continuing on foot

You see a car park, park your vehicle and want to continue to the destination on foot.

1. Tap on the  (Parking) button.
2. Tap on Pedestrian mode.

The following message appears: "Your current position has been saved. You will find it in the 'Favourites' list as 'My Vehicle'. This enables you to easily find the way back to your vehicle."

3. Tap on OK.

The position of your vehicle is marked on the map by a flag with a star.

The navigation continues to guide you to the destination in **Pedestrian mode**.

Searching for a car park

You want to be guided to a car park near the destination. From there you want to walk to the destination.

1. Tap on the  (Parking) button.
2. Tap on Parking Close to Destination.

A list opens. You are shown possible car parks in order of distance from your destination.

3. Tap on the car park where you want to park your vehicle.

You are shown more information about this car park.

4. Tap on Add.
5. The navigation now guides to the selected car park in the mode corresponding to the selected route profile. When you arrive there, the following message appears: "Your current position has been saved. You will find it in the 'Favourites' list as 'My Vehicle'. This enables you to easily find the way back to your vehicle."
6. Tap on OK.

The position of your vehicle is marked on the map by a flag with a star.

The navigation continues to guide you to the destination in **Pedestrian** mode.

Back to the destination

You have reached your destination. Navigation has ended. For some reason, however, you carry on driving, perhaps because you were unable to find a place to stop. Now you want to be guided back to the destination.

1. Tap on the  (Parking) button.
2. Tap on Last Destination.

The navigation now guides you back to the original destination in the mode corresponding to the selected route profile.

NAVIGON Clever Parking: Current information about parking options

Some parking options are marked by a small asterisk (e.g. ). There is more information available for these parking options, e.g. opening times or the number of parking spaces for women or the number of parking spaces for the handicapped.

This information is becoming available for more and more parking options. Regular updates of this information can easily be obtained via the **NAVIGON Fresh** software. **NAVIGON Fresh** can be downloaded free of charge from the website www.navigon.com/fresh.



Note: The **NAVIGON Clever Parking** function is not available as standard. You can easily purchase it however via the **NAVIGON Fresh** software. **NAVIGON Fresh** can be downloaded free of charge from the website www.navigon.com/fresh.

10.5 Nearby

During the navigation, or after having opened the map using the Show Map button, you can have POIs, Favourites and traffic information of the current map view shown in a clearly arranged list.



Note: This function is not available if the map was opened in one of the modes **Destination search**, **Preview** or **Reality View**.

1. Tap on the map on a symbol which represents a POI, a favourite or a traffic message.

The **NEARBY** list opens. It contains all the POIs, favourites or traffic messages to be found in a small radius around the position on which you have tapped.

2. Tap on an entry in the list in order to receive detailed information about it.

You have the following options:

- ▶ Tap on Interim Destination in order to set the selected point as an interim destination. The navigation system will first guide you to this interim destination. Afterwards you can continue navigation to your original destination. The Interim Destination button is available in navigation mode only.
- ▶ Tap on Start Navigation in order to navigate to the selected point.
- ▶ Tap on Cancel in order to close the list again.

10.6 MyBest POI: POI on Your Route



Note: This function is available only during navigation in **Vehicle mode** (refer to "Navigation in Vehicle mode" on page 60).

You can stipulate 3 categories of POI for the **POI on Your Route** function. POIs which lie along your route and match one of these categories can be quickly displayed and selected as an interim destination during the navigation.

10.6.1 Displaying POIs along the route

1. Tap on the (POI on Your Route) button which appears at the top left of the map (refer to point 2 in "Navigation in Vehicle mode" on page 60).

The **POI on Your Route** bar opens.



It shows symbols of the 3 stipulated categories of POI. The distance to the nearest POI in each category is indicated. The marking along the route also indicates whether the POI lies on the right () or left () in driving direction.

Note: The **POI on Your Route** bar closes after a few seconds.



If you want the bar to remain open, tap on the (Fix) button. The

button changes to (Fixed).

2. Tap on one of the categories in order to show a list with more POIs in this category.

The **POI ON YOUR ROUTE** list opens.

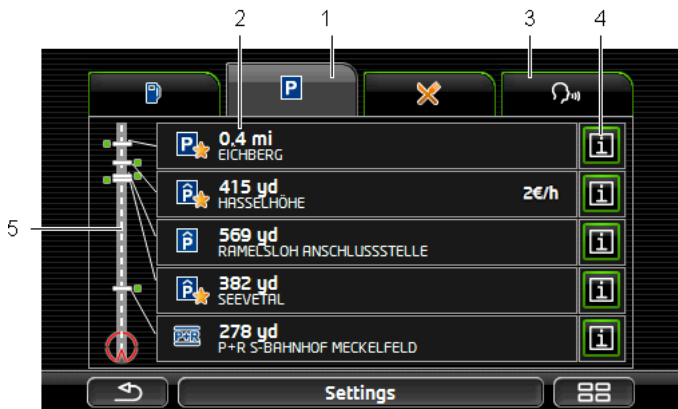

- 1 Symbols of those categories in which POIs are available are shown at the top edge of the screen. The symbol of the currently selected category is highlighted.
 - ▶ Tap on the symbol of the category whose POIs you want to have displayed.
- 2 The list contains the next 5 POIs, sorted by distance in descending order, which lie along your route and are in the stipulated category. The nearest POI is therefore the lowest entry in the list.
- 3 Voice Command: Opens the **VOICE COMMAND** window in which you can initiate the search for POIs by voice commands (refer also to "Voice Command" on page 28).



Note: If the voice commands function is not available for the language of the user interface, the Voice Command button will be deactivated.

- 4 Additional information about each POI in the list can be displayed.
 - ▶ Tap on the **i** (Info) button on the right alongside the corresponding POI (refer also to "Information about the destination" on page 41).
- 5 The route and your current position are shown schematically on the left edge of the screen. The markings along the route indicate the distance of the listed destinations from your position. The markings indicate whether the respective destination is on the right (—) or on the left (—) in driving direction.

10.6.2 Navigating to one of the destinations

- ▶ Tap in the list on the destination to which you want to navigate.

The selected destination will be inserted as an interim destination. The system recalculates the route. Navigation to the original destination will be continued after reaching the interim destination.

10.6.3 Selecting categories

You can stipulate which 3 categories or sub-categories are to be available for the POIs along the route.

1. Tap in the **POI ON YOUR ROUTE** list on [Settings](#).
The **SETTINGS: POI ON YOUR ROUTE** window opens.
2. Tap on the  ([List](#)) button alongside the category you want.
The list of POI categories will open.

If any sub-categories exist for a category, the  ([List](#)) button will be shown again alongside it. Tap on this button to show the sub-categories.

3. Select a category.
4. Tap on [OK](#).
The **SETTINGS: POI ON YOUR ROUTE** window opens.
5. Tap on [OK](#).
6. The **POI ON YOUR ROUTE** list opens. If there are POIs of the newly selected category along the route, they will already appear in the list.
7. Tap on  ([Back](#)) in order to close the list.
The map opens.

10.7 NAVIGON Sightseeing

NAVIGON Sightseeing sights are a special category of POI. You can be pointed to these sights when you get close to them.



Note: Pointers are possible only during navigation or when the map is opened in **Standard** mode.

Activating pointers to NAVIGON Sightseeing sights

You can select whether or how you want to be pointed to **NAVIGON Sightseeing** sights.

1. In the **NAVIGATION** window tap on [Options](#) > [Settings](#) > [Navigation](#) > [Info about 'NAVIGON Sightseeing' Destinations](#).
2. Select one of the following settings:
 - ▶ **No:** You will not be pointed to **NAVIGON Sightseeing** sights.

- ▶ Only on the Screen: When you get close to a **NAVIGON**

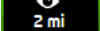
Sightseeing sight, the  (NAVIGON Sightseeing) button will appear on the map and can be used to open the **DESTINATION INFO** window.

- ▶ Audio Info for Important Destinations: For nationally known sights, a description will be read out as soon as the



(NAVIGON Sightseeing) button appears.

- ▶ Audio Info for All Destinations: For all sights in the category, a description will be read out as soon as the



(NAVIGON Sightseeing) button appears.



Note: Only a limited number of **NAVIGON Sightseeing** sights are included in the delivery package. An update with many additional sights in 18 European countries and particularly in-depth information about each **NAVIGON Sightseeing** sight can be easily purchased via the **NAVIGON Fresh** software. **NAVIGON Fresh** can be downloaded free of charge from the website www.navigon.com/fresh.



Note: Descriptions cannot be read out in every language. In this case the two settings Audio Info for Important Destinations and Audio Info for All Destinations are not available.



Note: During navigation in **Pedestrian** mode you will receive a pointer only when your destination is a **NAVIGON Sightseeing** destination and you are getting close to your destination.

Displaying information about a NAVIGON Sightseeing sight

- ▶ You have chosen to be informed about **NAVIGON Sightseeing** sights (refer to "Activating pointers to NAVIGON Sightseeing sights" on page 81).
- ▶ The map is open in **Navigation** or **Standard** mode.

When you get close to a **NAVIGON Sightseeing** sight, the





(NAVIGON Sightseeing) button will appear on the map. The distance indicated on the button tells you how far away the destination is (beeline). Depending on your settings, a description of the destination will be read out in addition.

- ▶ Tap on the  (NAVIGON Sightseeing) button.

The **DESTINATION INFO** window opens. In addition to a description it contains information such as the address, phone number or opening hours.

You have the following options:

- ▶ Tap on  (Audio Info) in order to start or stop the description being read out.
- ▶ Tap on  (Show on Map) in order to show the sight on the map.
- ▶ Tap on  (Save Destination) in order to save the sight in the **FAVOURITES** list.
- ▶ Tap on the picture of the sight to show it in full screen mode.
Tap on the picture again in order to close full screen mode.
- ▶ During navigation: Tap on Interim Destination on order to insert the sight as an interim destination.
- ▶ If there is no navigation in progress: Tap on Start Navigation in order to start the navigation to this sight.
- ▶ Tap on Close in order to close the **DESTINATION INFO** window again and return to the map view.

10.8 Sightseeing Tours

Sightseeing Tours are predefined routes with destinations of scenic, cultural or touristic interest which are sorted according to various categories.



Note: The navigation software contains only a limited number of sightseeing tours. An update with more than 100 sightseeing tours can be purchased via **NAVIGON Fresh**. You can download the **NAVIGON Fresh** software free of charge from the website www.navigon.com/fresh.

1. In the **NAVIGATION** window, tap on Options > Sightseeing Tours.
The **SIGHTSEEING TOURS** window opens.
2. Enter the country in which you want to search for sightseeing tours (refer to "Specifying a destination" on page 32).
3. Select a category from which you would like to find a route.
The **NAME** list opens. It contains routes from the specified category, sorted alphabetically.
4. Tap on the name of the route.
The **DETAILS OF THE ROUTE** window opens.
It shows the name of the route, the length of the route, the estimated driving time and a short description of the route.
 - ▶ Tap on Info to receive a detailed description of the route.
 - ▶ Tap on Close to reopen the **DETAILS OF THE ROUTE** window.

On the Begin at... button you are told at which route point the route starts:

- ▶ First: You are guided from your current position to the advised starting point of the sightseeing tour. Navigation on the selected tour then begins.
- ▶ Nearest: You are guided from your current position to the most favourable starting point for the selected tour. Navigation on the selected tour then begins.

The most favourable starting point is

- ▶ for a round trip: the nearest point on the route.
 - ▶ for any other trip: the nearest end point (start or destination) of the route.
5. Tap on Begin at... in order to select the alternative setting.
 6. Tap on Plan route.

The **ROUTES AND TRACKS** window opens. (Refer also to Tracks and multi-leg routes on page 49)

Here you can obtain an overview of the various legs of the selected tour and of the order the legs will follow.



Note: The list of route points in the **ROUTES AND TRACKS** window is for orientation purposes only. It is impossible in this list to change the order of the route points, delete route points or add new route points.

-
- ▶ Tap on Show Route.
The map opens in **Preview** mode and you can start the navigation on the route.



Detailed information about starting the navigation and about the map in **Preview** mode can be found in the chapter "Map in Preview mode" on page 58.

10.9 Direct Help

If you arrive at the scene of an accident or have an accident yourself, it may be necessary to call for emergency aid and to give the answering office your current location.

- ▶ In the **NAVIGATION** window, tap on Options > Direct Help.

If you are currently in a navigation:

- ▶ Tap on Options > Services > Direct Help.

The **DIRECT HELP** window opens.



If GPS reception is good enough, the address and the geographic coordinates of your current location will be indicated.

- ▶ Tap on  (Show on Map) if you want to view your current location on the map.

In the bottom half of the window you will find the buttons for 4 categories: Petrol Station, Police Station, Hospital, Pharmacy.

- ▶ Tap on the corresponding button.
The nearest help point in the selected category will be indicated. You are shown the name, address, phone number (if known) and distance of the help point from your current location.

You have the following options:

- ▶ Tap on the Map button in order to see your location and the help point on the map. This gives you an overview of the route to the help point.
- ▶ Tap on Start Navigation. You will then be guided directly to the displayed help point.
- ▶ You can use the  (Up) and  (Down) buttons to select other help points in the selected category.
The help points are sorted by distance from your current position.
- ▶ Use the  (Back) button to return to the **DIRECT HELP** window.



Note: Only those help points are displayed which are situated no further than than 30 mi from your position.

10.10 GPS Status, saving the current location

In the **GPS STATUS** window you will find an overview of the data the navigation system calculates from the GPS signals it receives.

The GPS status can be accessed from the options button in many windows.

- ▶ Tap on Options > GPS Status.

The current location can be saved in the **FAVOURITES** list.

1. Tap on Save Position.
The **SAVE DESTINATION AS** dialog box opens.
2. Enter a name for the destination.
3. Tap on Save.

10.11 Block

You can block a leg of the route at any time during a navigation, i.e. to re-calculate the route in order to avoid the leg, e.g. if you have heard on the radio of a traffic jam affecting this section.



Note: The block is valid only for the current navigation. It no longer exists on a new navigation.

You are currently in a navigation. The map is open in **Navigation** mode.

1. Tap on Options.
Buttons with various functions will be displayed.
 2. Tap on Block.
The **BLOCK** menu opens. It contains buttons with different distance values.
 3. Select the distance you want to block.
-



Note: If you are currently driving on a motorway, the alternative route will begin at the next exit. Indicated on the buttons is the junction up to which the block extends.

The system recalculates the route. The blocked route section will be avoided. It is marked on the map in red.

Unblocking a route section

- ▶ Tap on Options > Unblock.
The block will be lifted. The system recalculates the route. The unblocked route section can now be integrated into the calculation.

10.12 Turn-by-Turn List

You can display detailed directions of the calculated route before starting navigation or at any time during navigation. This list displays all of the driving instructions in table form.

The map is open in **Preview** mode:

- ▶ Tap on Options > Turn-by-Turn List.

The map is open in **Navigation** mode or in **Reality View** mode:

- ▶ Tap on Options > Route > Turn-by-Turn List.

The **TURN-BY-TURN LIST** window opens.

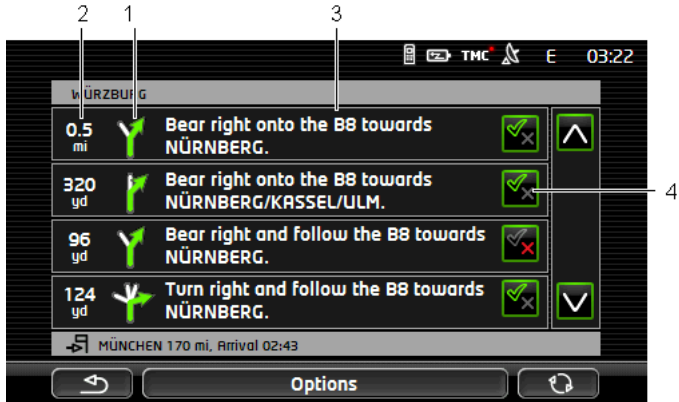

- 1 Schematic depiction of the next junction where you must make a turn.
- 2 Distance to this junction.
- 3 Route instruction and if available the name of the street into which you must turn.
- 4 Indicates whether you want to drive on the route section in question or not.

(Allow): The section in question is allowed on the route.

(Forbid): The section in question is not allowed on the route.

Blocking route sections

1. Tap on the route sections that you do not want to travel on so that the (Forbid) symbol appears next to them.
2. Tap on (Modify Route).
The navigation system calculates an alternative route avoiding the route sections selected. The new driving instructions are displayed in the **TURN-BY-TURN LIST** window.
3. Tap on (Back) in order to close the **TURN-BY-TURN LIST** window again.

Removing blocks and using original routes

Section blocks can be removed at any time.

- ▶ In the **TURN-BY-TURN LIST** window, tap on Options > Calculate Original Route.

10.13 TMC (Traffic Information)

The integrated TMC receiver enables the navigation system to make use of current traffic messaging. If necessary it can change your route dynamically, for example in order to avoid a traffic jam.

Note: TMC is available free of charge in many European countries. PremiumTMC, promising a faster and more up-to-date service, is offered (exclusively or in addition) in some countries at a charge.



The PremiumTMC services from TrafficMaster (UK) and ViaMichelin (F) are included in the delivery package.

You can easily subscribe to additional PremiumTMC services via the **NAVIGON Fresh** software. **NAVIGON Fresh** can be downloaded free of charge from the website www.navigon.com/fresh.

10.13.1 Preview TMC

If a new traffic message concerning your route arises while navigation is in progress, the Traffic Information button will appear at the right edge of the screen.

Recalculate Route: Automatically

If you have selected Automatically for the Recalculate Route setting, the button will not show a distance. The traffic obstruction will be avoided automatically if this can justifiably shorten the trip. If not, the traffic information will be ignored.

Recalculate Route: On Request

If you have selected On Request, then the distance to the reported traffic obstruction will be indicated on the button. The button will turn red if the distance is less than 50 km.

- ▶ Tap on the  (Traffic Information) button.

The **PREVIEW TMC** window opens. It shows a map view with the route section affected by the message. If the reported obstruction is likely to involve a considerable loss of time, a possible detour will also be shown.



Zoom Out: The map section shown becomes larger, but you will see fewer details.



Zoom In: The map section becomes smaller, but you will see more details.



Original map section: The original map section is shown again.

- ▶ Tap on the button of the route you want to follow.

- or -

- ▶ Tap on the Details button.

The **TRAFFIC INFORMATION** window opens. (Refer to "Displaying traffic information" on page 90)



Note: If you tap on a traffic symbol (in the display: ) in the map view of the **PREVIEW TMC**, a window with detailed information about this message will open. (Refer to "Showing a single message in detail" on page 91)

Recalculate Route: On Request

If you have selected On Request, the button may also appear in green. In this case there is no longer a traffic obstruction requiring a detour.

- ▶ Tap on the  (**Traffic Information**) button.

The **PREVIEW TMC** window opens (see above). You can now have yourself guided back to the original route or continue on the detour.

10.13.2 Displaying traffic information

Current traffic information is available via the options button in many windows.

- ▶ In the **NAVIGATION** window, tap on Options > Traffic.

The **TRAFFIC INFORMATION** window opens.

You can use the  (Up) and  (Down) buttons to scroll in the list of messages.

- ▶ Tap on  (Back) in order to close the **TRAFFIC INFORMATION** window again.

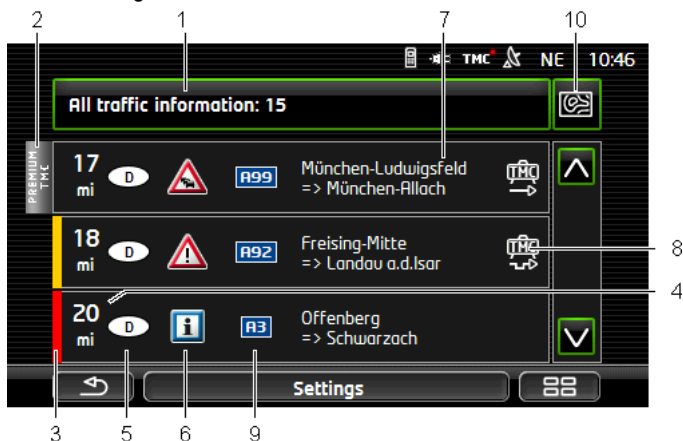

- 1 The Traffic Information button shows the type of traffic messaging listed and how many messages of this type are in the list.

- ▶ Tap on Traffic Information in order to select the messages you want displayed.

- 2 This mark indicates that the message in question comes from a PremiumTMC provider.

- 3 Here you can see how serious the obstruction is:

Red: The affected section of the route is fully blocked by the obstruction or involves a considerable loss of time (more than 30 minutes) to pass through. This can be the case for example when several lanes are blocked due to an accident.

Yellow: The section is not fully blocked by the obstruction but there is a threat of delays (10-30 minutes). This can be the case for example with slow-moving traffic.

No colour: The obstruction is not classified as serious. This can be the case for example when slow-moving traffic is reported on a very short section, when SOS telephones are not working or when parking areas are blocked off.

4 Here you can see how far you are from this obstruction. If the obstruction does not lie on your route or if a detour route was already calculated for this obstruction, then the distance as the crow flies will be shown.



5 Here you can see in which state the obstruction lies.



Note: Most radio stations report only traffic obstructions in their own state.

6 Here the reported obstruction is displayed as a traffic sign.

7 Here you can see on which section of the road the obstruction lies.

8 The navigation system can either Detour  or Ignore  congestion on the route. The button indicates the respective status. Tap on the button to select the alternative setting.

9 Here the affected road is indicated.

10  (Show on Map): This button is only available if at least one of the indicated messages concerns your route. Tap on this button in order to open the **PREVIEW TMC** window. (Refer to "Preview TMC" on page 88)

10.13.3 Showing a single message in detail

- ▶ Tap on a message to display this information in detail.



The navigation system announces the traffic message in question if the detail view is open. Reading out text messages is not possible in all languages however.

- ▶ Tap on the  (Show on Map) button in order to view the section concerned on the map.

10.13.4 TMC Settings

- ▶ In the **TRAFFIC INFORMATION** window tap on Settings.

In the **TMC SETTINGS** window you can set the TMC traffic station and configure whether the reception of a traffic message concerning your route should affect your route planning and if so how.

Tuning Mode

Tap on Tuning Mode and select a method for selecting the TMC radio station.

- ▶ Automatic: You can use the arrow keys in the station area to select another station. The system will search for another station if reception becomes poor.
- ▶ Hold station: You can use the arrow keys in the station area to select another station. The system will search for the same station on a different frequency if the signal becomes poor.
- ▶ Hold frequency: You can use the arrow keys in the station area to select another frequency. The system will not search for another station if reception becomes poor.

Recalculate Route

Tap on Recalculate Route and select how new traffic messages concerning your route are to be used.

- ▶ Automatically: An alternative route will be calculated automatically. The system will inform you on the recalculation.
- ▶ On Request: An announcement from the navigation device tells you that a traffic message concerns your route. On the screen the Traffic Information box indicates the distance to the reported traffic obstruction.

Tap on the Traffic Information box. You can then decide whether an alternative route is to be calculated or not.

10.14 Logbook

You can use your navigation device to record a logbook. The logbook is recorded in the "Logbook.xls" file. You can open the file with Microsoft Excel. Each recorded trip is added at the bottom of the table as a new entry.

The first time a trip is recorded, the "Logbook.xls" file will be created in the "NAVIGON\Logbook" folder. If you delete, move or rename this file, a new file will be created when you next record a trip.

Recording trips

You can have all trips recorded automatically.

1. In the **NAVIGATION** window tap on Options > Settings > Navigation.
2. Set Logbook to Yes.
3. Tap on OK.

Every trip from now on will be recorded until you reset Logbook to No. It is possible, however, to exclude individual trips from the recording.



The navigation system also records trips when you are not navigating. Of course this requires the navigation system to be switched on and receiving GPS signals.

Before a trip

If your trips are recorded in the logbook, a window for entering the trip's key data is opened before the trip begins. You can also decide, however, not to record the trip in question.

- ▶ If you don't want to record the trip in question, tap on  (Cancel).
 - or -
- 1. In the Reason for the Trip box tap on one of the possible reasons for the trip.
- 2. Enter a name for this entry, e.g. "Trip to customer X", in the Logbook Entry box.
- 3. Tap on Mileage.
- 4. Enter the mileage of your vehicle.
- 5. Tap on Start.
Navigation starts.

11 Car Info

When the cradle is correctly fitted in the vehicle and the navigation device is inserted, you can use many innovative functions to monitor vehicle data and assess your driving style.

You can use these functions when the following requirements are met:

- ▶ The cradle of the navigation device is correctly fitted in the vehicle (refer to "Mounting the navigation device" on page 13).
- ▶ The navigation device is correctly inserted in the cradle (refer to "Fitting the cradle ☺" on page 13).
- ▶ The vehicle ignition is on.

11.1 Low fuel warning

The low fuel warning is active when the map is opened in **Standard** mode or in **Navigation** mode. It appears as soon as the reserve fuel tank indicator appears on the vehicle's instrument panel.

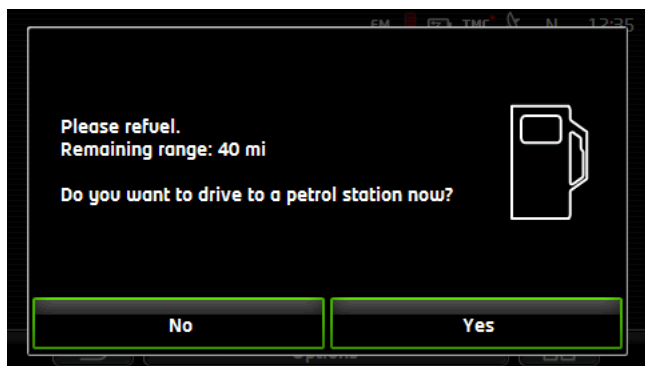

The indicated remaining range depends on the current consumption.

- ▶ Tap on No if you do not want to buy more fuel until later.

While navigation is in progress (map in Navigation mode)

1. Tap on Yes if you want to drive to a petrol station now.
The **POI ON YOUR ROUTE** list opens. It shows the nearest petrol stations along your route.
2. Tap on the name of the petrol station you want to drive to.
The petrol station will be inserted as an interim destination. Navigation to this station will start. Navigation to the original destination will be continued after you have bought more petrol.

No navigation in progress (map in Standard mode)

1. Tap on Yes if you want to drive to a petrol station now.
The **POI NEARBY** window opens. It shows petrol stations in your vicinity.
2. Tap on the name of the petrol station you want to drive to.
Navigation to the petrol station starts.

11.2 Optical parking system (OPS), Reversing assistance



Note: Reversing assistance is available only when the corresponding reversing sensors are fitted to the vehicle.



Note: Information about reversing assistance can also be found in the user manual issued for your vehicle, section "OPS" or "Optical parking system".

Reversing assistance gives you assurance when driving backwards, particularly when parking. It indicates the distance and the position of obstacles behind the vehicle.

Parking assistance is activated as soon as you engage the reverse gear. The space behind the vehicle is divided into three zones.

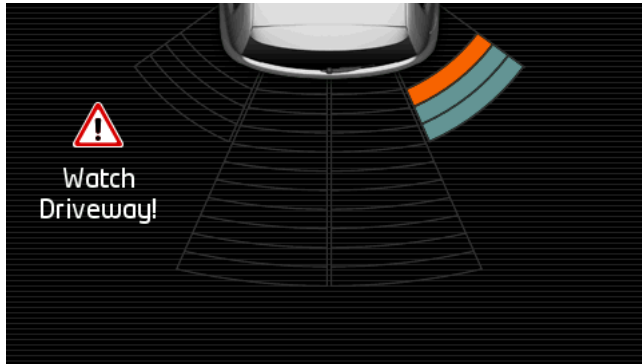

When you approach an obstacle while reversing, the distance to each of the reversing sensors is indicated visually by bars. As soon as you get very close to the obstacle, the bars turn red.

At the same time an audible warning is given as soon as the first coloured bar appears. The audible warning comprises a sequence of high-pitch tones. The closer the obstacle, the faster the sequence of tones. When the first red bar appears, you will hear a continuous tone.

- ▶ Tap on the screen to hide the reversing assistance.



Caution! It is possible that the distance from very narrow, pointed or very low obstacles will not be correctly indicated. Similarly it is possible that high obstacles such as branches will not be detected. Use of the reversing assistance does not release the driver from his duty to exercise all due care.



Note: The optical and acoustic reversing assistance is interrupted when a mobile phone is connected to the navigation device and a call is received.

11.3 Door monitoring



Note: Door monitoring is available only when the vehicle has central locking.

The door monitoring function always warns you when a door in your vehicle is open.

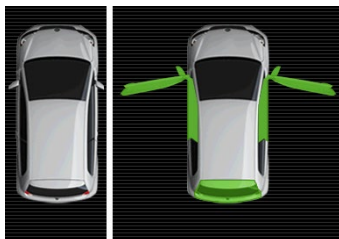

When a door is open, it is pictured as open and highlighted in colour.

- ▶ Tap on the screen to hide the door monitoring.



Caution! Door monitoring does not release the driver from his duty to exercise all due care.



Note: The door monitoring function is interrupted or suppressed

- ▶ when a mobile phone is connected to the navigation device and a call is received,
- ▶ when reversing assistance is active.

11.4 Trip Computer

The trip computer presents your vehicle's travel and consumption data.

11.4.1 Opening the trip computer

1. If necessary, tap on  (Main menu) to open the **START** window.
2. In the **START** window, tap on Car Info > Trip Computer.

The **TRIP COMPUTER** window opens.

The trip computer presents the following data:

- ▶ Average speed
- ▶ Distance driven
- ▶ Remaining range
- ▶ Average consumption
- ▶ Driving time
- ▶ Current consumption

On the button at the bottom edge of the screen you can see whether the indicated data are for the current trip (**Since Start**) or for the period since the data were last reset (**Long term**).

11.4.2 Selecting the period

In the **TRIP COMPUTER** window tap on the **Period** button (it is labelled with Since Start or with Long term).

Select the period for which you want the data to be presented.

- ▶ Since Start: This period will always begin again when the ignition has been off for 2 hours or more.
- ▶ Long term: This period will always begin again when you press and hold the reset button of the day odometer on the vehicle's instrument panel for at least 5 seconds.

11.5 Status

The navigation device can show two round instruments. You can configure which instruments are shown.

11.5.1 Opening the Status window

1. If necessary, tap on  (Main menu) to open the **START** window.
2. In the **START** window, tap on Car Info > Status.
The **STATUS** window opens.

11.5.2 Configuring the Status window

The navigation device can show the following instruments:

- ▶ RPM Gauge
- ▶ Coolant Temperature
- ▶ Outside Temperature



Note: It is possible that your vehicle does not support all the instruments which can be shown by the navigation device. In this case the choice will be limited.

1. In the **STATUS** window tap on Car Info > Gauge 1 to configure the left round instrument.
- or -
 - ▶ In the **STATUS** window tap on Car Info > Gauge 2 to configure the right round instrument.
- or -
 - ▶ In the **STATUS** window tap on the round instrument which you want to reconfigure.
The **GAUGE 1** or **GAUGE 2** list opens. It contains all the instruments which can be shown. The instrument currently presented is marked.
2. Tap on the instrument which you want to be shown.

3. Tap on OK.

12 Media

The integrated multimedia application can be used

- ▶ To control the car radio
- ▶ To control the CD player in the car radio
- ▶ To play back audio files from a memory card in the navigation device
- ▶ To play back audio files from a device connected via Bluetooth (phone, smartphone or Bluetooth-capable MP3 player)
- ▶ To play back audio files from a device which is connected to the AUX input of the car radio
- ▶ To view graphic files from a memory card in the navigation device

12.1 Controlling the car radio

You can use the navigation device to control basic functions of the car radio.

1. If necessary, tap on  (Main menu) to open the **START** window.
2. In the **START** window, tap on Media > Radio.
The **RADIO** window opens.

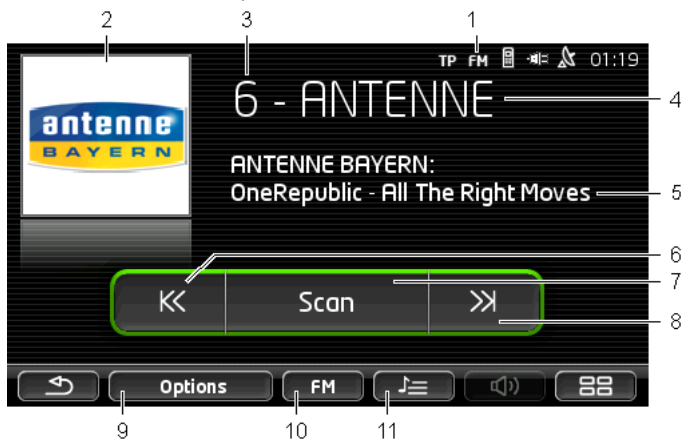

- 1 Indication of the currently selected frequency band (see also point 10)
- 2 Logo of the radio station. The logo is shown only when it is available.



Note: More and more logos are becoming available. You can easily update the logos in your navigation device via the **NAVIGON Fresh** software. **NAVIGON Fresh** can be downloaded free of charge from the website www.navigon.com/fresh.



- 3 Memory number. When the radio station is saved in the radio, the number of the memory location is indicated here.
- 4 Name of the radio station. If the station does not transmit its name, the station's frequency will be indicated here.
- 5 Radio text. If the station transmits radio text, the text will be shown here.
- 6 Tuning Down. Searches for the next lower frequency at which the radio station can be received. Refer to also "Selecting a radio station" on page 100)
- 7 Scan. Searches the entire frequency band for radio stations. Each station found is played for several seconds before the next is searched for.
- 8 Tuning Up. Searches for the next higher frequency at which a radio station can be received. (Refer also to "Selecting a radio station" on page 100)
- 9 Options. Here you can adjust the sound settings. Also, you can decide whether traffic announcements are to be phased in or not.
- 10 Radio Spectrum. Here you can set the frequency band. The current frequency band (AM or FM) is indicated on the button.
- 11 Preset List. Here you can save the current radio station or select a different saved station.

12.1.1 Selecting the frequency band

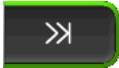

The Radio Spectrum button indicates the current frequency band (AM or FM).

1. Tap in the **RADIO** window on the Radio Spectrum button.
The list of available frequency bands is opened.
2. Tap on the frequency band from which you want to receive radio stations.

12.1.2 Setting a certain frequency

- ▶ In the **RADIO** window tap on  (Up) or  (Down) until the **FREQUENCY** window opens.

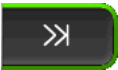
The frequency can be changed in steps of 0.1MHz (FM) or 9kHz (AM).

- ▶ Tap briefly on  (Up) or  (Down) to change the frequency by one step.
- ▶ Tap longer on the buttons to change the frequency by several steps.
- ▶ Tap on  (Back) in order to return to the **RADIO** window.

12.1.3 Selecting a radio station

Instead of setting a specific frequency you can search manually for radio stations.

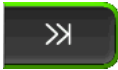
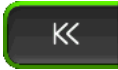

Note: In the car radio you can set whether the radio station search function is to search for all stations or whether only the stations in the memory list are to be searched through. For details refer to the manual issued for the radio.

- ▶ In the **RADIO** window tap on  (Tuning Up) to search for the next higher frequency at which a radio station can be received.
- ▶ In the **RADIO** window tap on  (Tuning Down) to search for the next lower frequency at which a radio station can be received.

When the phasing in of traffic messages is activated (TP), only those radio stations which transmit traffic information are found.

12.1.4 Scan: Scanning the frequency band

The navigation device offers the possibility of scanning the current frequency band automatically. Each radio station found is played for several seconds before the next is searched for.

1. In the **RADIO** window tap on Scan.
The search begins. As long as searching is in progress, the Scan button is highlighted in colour (black). Also, the word **Scan** is visible at the top edge of the screen.
2. Tap again on Scan when you find a radio station you like.
The search is ended.

12.1.5 Preset List



For each frequency band there are 12 memory locations at which you can save your favourite radio stations.

Saving a radio station

Set the radio station you want to save. You can set the station either on the navigation device or on the radio.

1. In the **RADIO** window tap on  (Preset List).
The memory list for the current frequency band is opened.
2. Tap on the memory location where you want to save the radio station until you hear a confirmation tone.
The radio station is now saved.
3. Tap on Close.
The **RADIO** window opens again. The number of the memory location is now shown in front of the name of the radio station.

Selecting a saved radio station

1. In the **RADIO** window tap on  (Preset List).
The memory list for the current frequency band is opened.
2. Tap on the memory location of the radio station which you want to listen to.
Alongside the name of the radio station appears the  (**Current Station**) symbol and the station can be heard.
3. Tap on Close.
The **RADIO** window opens again. The name of the radio station and the number of the memory location are indicated.

12.2 Media Player

You can use the navigation device as a media player.

1. If necessary, tap on  (Main menu) to open the **START** window.
2. In the **START** window, tap on Media > Media Player.
The **MEDIA PLAYER** window opens.

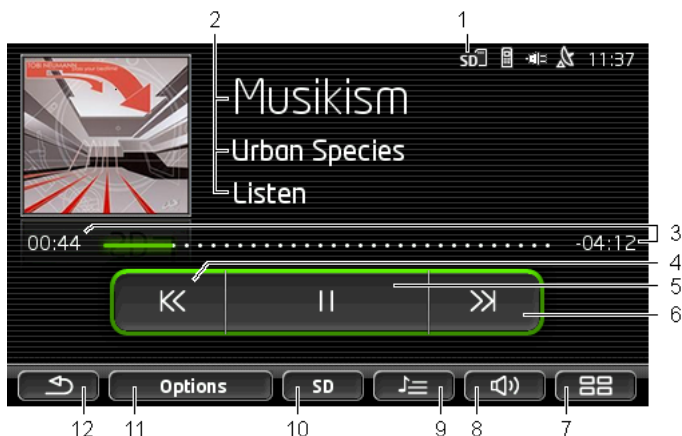

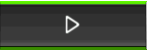
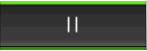
- 1 Currently selected source. See also point 10.
- 2 Media data (ID3 tag). Here you are shown (from top to bottom) the name of the music item currently being played, the name of the artist and album, and the album cover (top left), provided these data have been saved in an ID3 tag. If no data are available, the file name is indicated along with the name of the folder in which the file is saved.
- 3 Progress indicator. Indicates the complete length of the audio file. The already played time of the current file is indicated on the left side of the progress indicator. It is represented by the coloured part of the indicator.
The still remaining time of the current file is indicated on the right side of the progress indicator. It is represented by the dotted part of the indicator.
 - ▶ Tap on the remaining time to show the total time of the current file.
 - ▶ Tap on the time of the total time to show the remaining time of the current file again.
- 4 Back
 - ▶ Press briefly: Play back the previous file
 - ▶ Press and hold: Fast rewind
- 5 Start / stop play back
 - ▶  Start play back
 - ▶  Stop play back
- 6 Forward
 - ▶ Press briefly: Play back the next file

- ▶ Press and hold: Fast forward
- 7 Opens the **START** window.
- 8 Opens the volume bar (available only when the system is not connected to the radio).
- 9 Opens the **FILE MANAGER** window. Here you can choose the media files which you want to play back. You can also set the order of play back and the repeat mode and you can start the scan function (Scan).
- 10 Media Source. The current source is indicated on the button and at the top right edge of the screen (see point 1). Possible sources: SD card, CD, BT-Audio, AUX.
- 11 Options, Sound and TP settings (only when the system is connected to the radio), see "Options for the radio and media player" on page 106.
- 12 Back to the previously opened window.

12.2.1 Supported audio files

You can control the play back of audio CDs which have been inserted in the CD player of the navigation device. Also, you can play back audio files in the following formats:

MP3, WMA, OGG Vorbis, AAC, FLAC

12.2.2 Selecting a media source

The current source is indicated on the Media Source button (AUX, BT, CD or SD).

1. Tap in the **MEDIA PLAYER** window on the Media Source button.

The media source list opens.

 - ▶ AUX: An external device which is connected by cable to the AUX input of the car radio. For details refer to the manual issued for your car radio.
 - ▶ BT-Audio: A device (mobile phone, smartphone or Bluetooth-capable MP3 player) which is connected by Bluetooth to the navigation device. The device must support the Bluetooth protocol A2DP. When two such devices are connected to the navigation device, both are listed here.
 - ▶ CD: A CD which is inserted in the car radio. For details refer to the manual issued for your car radio.
 - ▶ SD card: An SD card which is inserted in the navigation device.

The current source is marked by a coloured dot (green).
Tap on the source which has the files you want to listen to.



For details of how to connect a Bluetooth-capable device to the navigation system refer to the chapter "Bluetooth Connection" on page 113.



Note: Not all Bluetooth-capable devices are 100% compatible. Depending on the device, some functions may not be supported at all or only with limitations.



Note: When the navigation device is not mounted in the vehicle, AUX and CD are not listed.

When the **AUX** input is deactivated in the car radio settings, AUX is not listed. For details refer to the manual issued for your radio.



Note: When playing back files with BT-Audio, dropouts may occur if the distance between the navigation device and the connected device (mobile phone, smartphone or Bluetooth-capable MP3 player) is too big or if there are objects between the devices.



Note: A change of memory card is detected only when the device has been switched on. If the memory card is not detected, insert it again when the device is on and running.

12.2.3 Selecting files for playing back

- ▶ In the **MEDIA PLAYER** window tap on  (File Manager).
The **FILE MANAGER** window opens.

At the top of the list is the name of the folder whose contents are now being shown. It is followed underneath in alphabetical order first by the sub-folders, then by the files in the current folder. They are identified as follows:



Folder : Sub-folders of the current folder are shown.



- ▶ Tap on a sub-folder in order to open it.
-



Note: If the sub-folder has no playable audio files and no sub-folders, it cannot be opened.



File: Only files which can be played back by the media player are shown. (Refer to "Supported audio files" on page 103)

- ▶ Tap on  (Up one level) in order to open the next higher folder.
- ▶ Tap on the name of a media file in order to select it for playing back. Alongside the name of the file appears the  (**Current File**) symbol and this file can be heard. The file will remain selected even if you open another folder.

Tap on  (Close) in order to return to the **MEDIA PLAYER** window.

12.2.4 Selecting the play-back mode

The files of the current folder can be played back in various ways.

1. In the **MEDIA PLAYER** window tap on  (File Manager).

The **FILE MANAGER** window opens.

Visible at the bottom edge of the window are buttons for the play-back modes.

The current play-back mode is highlighted in colour (black).

 (Standard): The items of the current folder will be played in the indicated order.

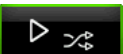
 (Mix): The items of the current folder and its sub-folders will be played in random order.

 (Repeat): The items of the current folder and its sub-folders will be played in the order indicated. When all the items have been played, play back starts again from the beginning.

 (Scan): The items of the current folder and its sub-folders will be played briefly one after the other. Tap again on Scan if you want to listen to the current item in full.





Note: It is possible that the selected media source will not support all the play-back modes offered by the navigation device. In this case the selection will be limited.

2. Tap on the button of the play-back mode you want.
3. Tap on  (Close) in order to return to the **MEDIA PLAYER** window.

12.2.5 Controlling the play back

Three buttons are available for controlling the play back:

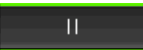
- ▶  (Back)
 - ▶ Press briefly: Play back the previous file
 - ▶ Press and hold: Fast rewind
- ▶  (Play): Starts the play back of the current file or continues it.
- ▶  (Pause): Interrupts the play back of the current file.

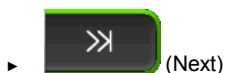

- ▶ Press briefly: Play back the next file
- ▶ Press and hold: Fast forward

12.3 Options for the radio and media player

In the options for audio applications you can regulate the sound and select whether you want traffic messages to be phased in.



Note: The options are available only when the navigation device is mounted in the vehicle.

12.3.1 Traffic Information (TP)

The car radio can phase out the playing back of music or navigation instructions and have traffic messages announced instead when traffic information is available.

When traffic messages are being phased in, the **TP** symbol is visible at the top edge of the screen.

1. Tap on the **RADIO** button or in the **MEDIA PLAYER** window on Options.

The list of available options. Alongside the **TP** entry you can see whether the phasing in of traffic messages is activated or not.

2. Tap on the **TP** entry to select the alternative setting.

When **TP** is activated and traffic information is being transmitted, a message window will appear.

- ▶ Tap on Cancel if you do not want to listen to the traffic information.

12.3.2 Sound

You can regulate the treble, bass and balance values on the navigation device.

- ▶ In the **RADIO** window or in the **MEDIA PLAYER** window tap on Options > Sound.

The **SOUND** window opens.

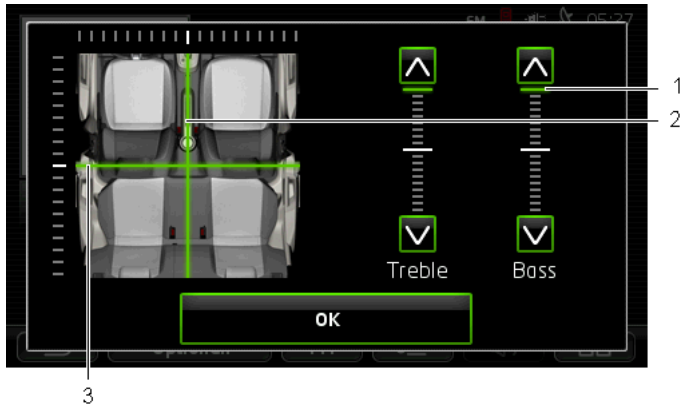

- 1 The values for treble and bass are indicated in colour on vertical scales (green).
- 2 The balance is presented in colour on a schematic view of the vehicle's interior (green).
- 3 If rear speakers are installed, the fader for the front-rear balance is also shown.

How to regulate the sound:

1. Shift the colour markings until you are satisfied with the sound.
2. Tap on OK.

12.3.3 Volume

The volume of the radio and the media player can be regulated independently.

When the device is mounted in the vehicle:

- ▶ You can regulate the volume on the radio when the **MEDIA PLAYER** window or the **RADIO** window is open and no navigation instruction is in the process of being announced.

When the device is not mounted in the vehicle:

1. Tap on  (Volume).

The volume bar opens. It contains three buttons for adjusting the volume.

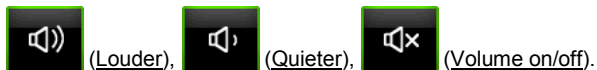

2. Tap on  (Volume) again or wait a few seconds.

The volume bar closes.

12.4 Pictures

The navigation device can show image files which are saved on a memory card which is inserted in the device.

12.4.1 Suitable files

The picture viewer can show files in the following formats: BMP, GIF, JPEG, JPG, PNG, TIF, TIFF.

Pictures for the picture viewer must not have more than 2048 x 1536 pixels.

They are also subject to file size limitations:

File format	Max. size
JPG, JPEG, BMP	4 MB
All others	1 MB

12.4.2 Opening the picture viewer

1. If necessary, tap on  (Main menu) to open the **START** window.
2. In the **START** window, tap on Media > Pictures.

12.4.3 Selecting an image file

- ▶ In the **PICTURES** window tap on Browse.

The **CURRENT FOLDER** window opens. The name of the current folder is indicated at the top. Underneath is a list of files and sub-folders. These are marked as follows:



Picture File: Only those files are indicated which are supported by the picture viewer. Refer to "Suitable files" on page 108)

After a short time a miniature view of the picture will appear instead of the  symbol.





Folder : Sub-folders of the current folder are shown.

- ▶ Tap on a sub-folder in order to open it.





Note: If the sub-folder contains no suitable image files or sub-folders, it cannot be opened.

- ▶ Tap on  (Up one level) in order to open the next higher folder.
- ▶ Tap on an image file in order to show it.

- ▶ Tap on  (Close) to close the **CURRENT FOLDER** window without selecting a file.

12.4.4 Operating the picture viewer

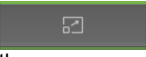
In the **PICTURES** window are three buttons for controlling the display:

- ▶  (Back): Shows the previous picture
- ▶  (Full Screen): Switches to **Full Screen** mode. Tap there on any point of the picture to close this mode again.
- ▶  (Next): Shows the next picture

12.4.5 Selecting the play-back mode

The viewing order of the pictures can be influenced.

1. In the **PICTURES** window tap on Browse.

The **FILE MANAGER** window opens.

Visible at the bottom edge of the window are buttons for the play-back modes.

 (Standard): All the pictures on the memory card will be shown in succession. Once all the pictures in a folder have been shown, the system moves to the next folder.

 (Mix): All the pictures on the memory card are shown in random order.

2. Tap on one of the two buttons to set the corresponding mode.
3. Tap on  (Close) in order to return to the **PICTURES** window.

12.5 Options for the picture viewer

In the options for the picture viewer you can start a slideshow or select the background picture for the screensaver.

12.5.1 Slideshow (Slide Show)

You can have the pictures on the memory card presented as a slideshow. No controls are then visible on the screen.



Note: When the navigation device is mounted in the vehicle, it is not possible to show a slideshow during a journey.

Slideshow

- ▶ In the **PICTURES** window, tap on Options > Slide Show.
The slideshow begins. The pictures on the memory card are shown one after the other. Once all the pictures of a folder have been shown, the pictures of the next folder will be shown.
- ▶ Tap on any point of the screen to end the slideshow.

Slideshow mix

- ▶ In the **PICTURES** window, tap on Options > Slide Show Mix.
The slideshow begins. The pictures on the memory card are shown in random order.
- ▶ Tap on any point of the screen to end the slideshow.

12.5.2 Background for the screensaver



Note: This function is not available as standard. However, you can install it very easily via the **NAVIGON Fresh** software. **NAVIGON Fresh** can be downloaded free of charge from the website www.navigon.com/fresh.

You can use any picture on the memory card as background for the screensaver.



For more details about the screensaver refer to chapter "Screensaver" on page 16.

Selecting a picture for the screensaver

1. Call up the picture which you want to use as background for the screensaver. Refer to "Selecting an image file" on page 108)
2. In the **PICTURES** window, tap on Options > Select picture for standby.
The picture will now be used as background for the screensaver.

Resetting the screensaver

- ▶ In the **PICTURES** window, tap on Options > Reset picture for standby.
The screensaver uses the standard graphic again.

13 Handsfree Module

The navigation device has a hands-free module which supports Bluetooth connections to Bluetooth-capable mobile phones, MP3 players and headsets. It can be connected simultaneously to up to two mobile phones or MP3 players or to a headset.

If you have set up a connection to a mobile phone, you can use the navigation device as a hands-free module for it.

If you have set up a connection to a Bluetooth headset, you will hear the voice instructions from the navigation software via the headset. This is useful for example when travelling on a motorcycle. All other functions described in this chapter are not available when connected to a headset.



Note: Not all Bluetooth-capable devices are 100% compatible. Depending on the device, some functions may not be supported at all or only with limitations. It may happen that a device (mobile phone, smartphone or Bluetooth-capable MP3 player) cannot be connected when a certain other device is already connected.

Opening the hands-free module

1. If necessary, tap on  (Main menu) to open the **START** window.
2. In the **START** window tap on Phone.

The **HANDSFREE MODULE** window opens.

When you start the hands-free module for the first time, a window will open in which you can start a search for Bluetooth-capable devices.

- ▶ Tap on Yes if you want to start the search now and set up a connection to a headset or a mobile phone. As soon as the navigation device has found your Bluetooth device you can initiate the pairing. (Refer to "Pairing with a device" on page 114)
- ▶ Tap on No if you want to initiate the connection later. (Refer to chapter "Searching for and pairing Bluetooth devices" on page 113)

Elements of the hands-free module

All functions can be reached from the **HANDSFREE MODULE** window.



1 Status display of the hands-free module. This status display can also be seen in the navigation software. (Refer to "Bluetooth / Phone" on page 24)

2 The **Phone 1** and **Phone 2** buttons are used to select the active phone. (Refer to "Activating a mobile phone" on page 116)

The button of the currently active phone has a "pressed" look (here: **Phone 1**). The name of the active phone appears alongside the buttons. The symbols on the buttons can have various colours:

- ▶ Green if a mobile phone is connected as "Phone 1" or as "Phone 2".
- ▶ White if no mobile phone is connected.

If the hands-free module is connected to a headset, the



(**Headset**) button will appear.

3 Speed Call buttons. See "Preset" on page 125.

4 Back to the previously opened window.

5 Opens the **TRUSTED DEVICES** window. Here you can enter which devices are connected to the hands-free module. (Refer to "Connecting to a device" on page 115)

6 If you press this button, you will be returned to the **START** window.

The following labelled buttons are also visible:

Keyboard: Opens the keypad on which you can dial phone numbers. (Refer to "Dialling a telephone number" on page 121)

Phone Book: Opens the phone book of the active telephone. (Refer to "Calling a contact from the phone book" on page 121 and "Navigating to a contact from the phone book" on page 124)

Recent Calls: Opens the recent calls of the active telephone. (Refer to "Calling most recently dialled, received or missed numbers" on page 122)

Voice Command: Opens the **VOICE COMMAND** window in which you can initiate a call by voice commands. (Refer to "Making a call with the voice commands function" on page 120)



Note: If there is no connection to a mobile phone or if the voice commands function is not available for the language of the user interface, the Settings button will be shown instead of the Voice Command button.

13.1 Bluetooth Connection

To be able to use the hands-free module of the navigation device, it must be connected to at least one Bluetooth device.

Note: Both the navigation device and the mobile phone must be configured accordingly in order for a Bluetooth connection to be set up between the two devices. Headsets are suitably configured at the factory.



For details of how to configure the navigation device refer to the chapter "Settings" on page 125.

For details of how to configure the mobile phone or headset refer to the related manual issued by the manufacturer.

13.1.1 Searching for and pairing Bluetooth devices

Pairing is the term used for setting up a coded connection between two Bluetooth devices. This requires each of the two devices to send the same password to respectively the other device. The password and the connection data are saved on both devices, which means that pairing is necessary once only when the connection is set up for the first time. Paired devices are saved in the **TRUSTED DEVICES** list.

The navigation device can connect automatically to the last connected device as soon as it is within range.

The hands-free module of the navigation device can save and manage the connection data of up to 4 paired mobile phones or Bluetooth-capable MP3 players and one headset. From each paired mobile phone it is possible to import the phone book and recent calls and to save this information with the connection data.



Note: In this case the phone book and recent calls are only available when the phone in question is connected. For details of how to import the phone book and recent calls refer to the chapters "Import Phone Book" on page 117 and "Import recent calls" on page 118.

Searching for devices

1. Make sure that the Bluetooth function is activated on both the mobile phone and the navigation device. If you want to set up a connection to a headset, the headset must be switched on. Additional information can be found in the manual issued for the headset.
2. In the **HANDSFREE MODULE** window tap on  (**Trusted Devices**). The **TRUSTED DEVICES** window opens.
3. Tap on **Options** > **Search for Devices**.
The navigation device starts the search for Bluetooth devices and lists all the devices it recognises in the **DISCOVERED DEVICES** window. The symbol to the left of the device name indicates whether the device is a mobile phone or a headset.

Pairing with a device

4. Tap in the **DISCOVERED DEVICES** window on the name of the device you want to connect to.
 - ▶ If pairings already exist with 4 mobile phones or with a headset, you will now be prompted to delete a device from the **TRUSTED DEVICES** list. (Refer to "Deleting a device" on page 117)
5. The navigation device prompts you to enter a password.
 - ▶ If you are setting up a connection to a mobile phone, enter a password (1-16 digits) in the **Key** box and tap on **OK**. Then enter the same password on the mobile phone.
 - ▶ If you are setting up a connection to a headset, enter the headset password. This password and additional information about pairing can be found in the manual issued for the headset.
The pairing is performed and a connection is set up between the two devices. The connected device is indicated in the **TRUSTED DEVICES** list. (Green symbol)

13.1.2 Pairing from the mobile phone



Note: Please consult the mobile phone's manual if you are uncertain about how to carry out the following steps on the mobile phone.

1. Make sure that the Bluetooth function is activated on both the mobile phone and the navigation device. To perform the pairing from the mobile phone, the functions **Discoverable by Others** and **Others May Connect** must also be activated on the navigation device. (Refer to "Configuring the hands-free function" on page 125)
2. Using your mobile phone, search for other Bluetooth devices.
The navigation device is detected as **Car Phone**.

3. Initiate a connection to the detected **Car Phone** device.
The mobile phone prompts you to enter a password.
4. Enter a password (1-16 digits).
The navigation device prompts you to enter a password.
5. Enter the same password in the Key box as on the mobile phone and tap on OK.
The pairing is performed and a connection is set up between the two devices. The connected device is indicated in the **TRUSTED DEVICES** list.
 - ▶ If the new device is a headset, the symbol will appear to the right of its name in green colour. The connection to any mobile phones will be disconnected if applicable.
 - ▶ If the new device is a mobile phone, one of the two symbols will appear to the right of its name in green colour depending on whether it is connected as Phone 1 or as Phone 2.

13.1.3 Connecting to a device

In this case "connection" refers to any subsequent connections between Bluetooth devices which have already been paired. No further password entry is necessary when connecting.

1. Make sure that Bluetooth is activated on your navigation device.
 - ▶ If you want to connect to a mobile phone, make sure that Bluetooth is activated on the mobile phone and that the Discoverable by Others and Others May Connect settings are activated.







Note: The exact designation of these settings may vary from manufacturer to manufacturer. For details please refer to the manual issued for your mobile phone.

- ▶ If you want to connect to a headset, make sure that the headset is switched on.

Connecting manually

If a Bluetooth connection to a device is active, you must disconnect this connection first before you can connect to a different device. The existing connection is disconnected automatically as soon as the connection to a different device is initiated.

2. In the **HANDSFREE MODULE** window tap on  (Trusted Devices).
The **TRUSTED DEVICES** window opens. Currently connected devices are marked with a green symbol to the right of their name. Devices which are not connected have white symbols.
3. Please ensure that the Bluetooth connection is working properly.

- ▶ Tap on the  (**Connect**) symbol in order to initiate a connection to the corresponding headset. All active connections to other devices will then be disconnected.
- ▶ Tap on the  (**Connect**) symbol in order to connect the corresponding mobile phone as "Phone 1". The connection to a headset or to a device which is already connected as "Phone 1" will be disconnected.
- ▶ Tap on the  (**Connect**) symbol in order to connect the corresponding mobile phone as "Phone 2". The connection to a headset or to a device which is already connected as "Phone 2" will be disconnected.

The corresponding symbol will turn green. The navigation device connects to the selected device.

4. Tap on  (**Back**) in order to return to the **HANDSFREE MODULE** window.

If the telephone to which you want to connect the hands-free module is not in the list, you can start a search for Bluetooth devices. (Refer to "Searching for and pairing Bluetooth devices" on page 113)

Connecting automatically



Note: For automatic connection to be possible, the navigation device must be saved in the Bluetooth settings on your mobile phone as "authorised" or "authorised device" (the exact wording can vary from manufacturer to manufacturer). For details please refer to the manual issued for your mobile phone.

If the device you want to connect to was either of the two last connected devices and the Reconnect Automatically setting is activated, the connection will be set up automatically as soon as the device is within range.



13.1.4 Activating a mobile phone

If the hands-free module is connected to two mobile phones, you can select in the **HANDSFREE MODULE** window which is to be the active telephone.

If you want to call someone, the call will be made via the active phone. Incoming calls and text messages on the inactive telephone will be announced however and can be taken.

Recent calls and the phone book of the inactive telephone are not available.

You can activate only one connected telephone.



- ▶ Tap on the  (Phone 1) or  (Phone 2) button to activate the corresponding mobile phone.

The button of the active phone has a "pressed" look. The name of the active phone is shown to the right of the buttons.

If no mobile phone is connected yet as "Phone 1" or as "Phone 2", the symbol on the corresponding button will appear in white. If you tap on the symbol, the **TRUSTED DEVICES** window will open. There you can connect a mobile phone to the hands-free module. (Refer to "Connecting to a device" on page 115)

13.1.5 Deleting a device

You can delete the connection data of paired devices. The device is then no longer shown in the **TRUSTED DEVICES** list. If you imported the phone book or recent calls from this device, these data will be deleted from the navigation device.

1. In the **HANDSFREE MODULE** window tap on  (Trusted Devices).
The **TRUSTED DEVICES** window opens.
2. Tap on Options > Delete Device.
The **DELETE DEVICE** window opens.
3. Tap on the  (Delete Device) button to the right of the device you want to delete.
You will be requested to confirm deletion.
4. Tap on Delete.
The device is deleted from the **TRUSTED DEVICES** list.

13.1.6 Import Phone Book

For each paired mobile phone in the **TRUSTED DEVICES** list it is also possible to import its phone book and save it together with the connection data. Access to the phone book of a mobile phone is then only possible when the navigation device is connected to the mobile phone from which the phone book was imported. As soon as you connect to a different phone or disconnect the connection, the phone book will no longer be available on the hands-free module.

1. In the **HANDSFREE MODULE** window activate the mobile phone whose phone book you want to import. (Refer to "Activating a mobile phone" on page 116)
2. Tap in the **HANDSFREE MODULE** window on the Phone Book button.
The phone book import is started. Depending on the size of the phone book this can take some time. When the import is completed, the phone book is opened.



Note: The number of phone book entries that can be imported from the mobile phone is limited to 1000.



Note: It can take some time to import a phone book depending on its size. During the import you can move the Bluetooth application into the background in order e.g. to show the map during navigation. Tap in the window opened during the import on the To background button in order to move the navigation application into the foreground.

Editing and updating a phone book

The phone book cannot be edited in the hands-free module. If you want to change or delete an entry in the phone book, you must make the changes on your mobile phone and then update the phone book on the hands-free module. The phone book is re-imported for the update.

1. In the **HANDSFREE MODULE** window activate the mobile phone whose phone book you want to update. (Refer to "Activating a mobile phone" on page 116)
 2. Tap in the **HANDSFREE MODULE** window on the Phone Book button. The phone book of the active phone is opened.
 3. Tap on Options > Refresh.
The phone book import is started.
-



Note: Deleting the complete phone book is possible only by deleting the mobile phone from the **TRUSTED DEVICES** list (refer to "Deleting a device" on page 117). In this case the connection data, phone book and recent calls will all be deleted, which means that you will have to repeat the pairing routine in order to set up a connection with the device again.



For more details about the phone book refer to the chapter "Calling a contact from the phone book" on page 121.

13.1.7 Import recent calls

For each paired mobile phone in the **TRUSTED DEVICES** list it is also possible to import its recent calls and save them together with the connection data. Access to the recent calls of a mobile phone is then only possible when the navigation device is connected to the mobile phone from which the phone book was imported. As soon as you connect to a different phone or disconnect the connection, the recent calls will no longer be available on the hands-free module.



Note: The number of recent calls that can be imported from the mobile phone is limited to 20.

1. In the **HANDSFREE MODULE** window activate the mobile phone whose recent calls you want to import. (Refer to "Activating a mobile phone" on page 116)
2. Tap in the **HANDSFREE MODULE** window on the Recent Calls button.
The recent calls import is started. When the import is completed, the recent calls are shown.

13.2 Taking a call

When you receive a call, a ring tone will sound and the **INCOMING CALL** window will open. The header line shows which connected phone is receiving the call.

The name and the number of the caller will be displayed if this information is available. (If the caller's number is displayed but does not exist in the phone book, **Unknown number** will be displayed instead of the name. If the number is suppressed, **Anonymous** will be displayed.)

- ▶ Tap on Accept if you want to take the call.
The **CALL IN PROGRESS** window opens.
- ▶ Tap on Reject if you do not want to take the call.



Note: Navigation instructions are muted during a call.

13.3 Receiving a text message

The hands-free module can show incoming text messages (SMS).



Note: The showing of incoming text messages (SMS) on the hands-free module is not supported by every mobile phone.

When you receive a text message, a signal tone will sound and the **INCOMING TEXT MESSAGE** window will open. The header line shows which connected telephone received the text message.

The name and the number of the sender will be displayed if this information is available. (If the sender's number is displayed but does not exist in the phone book, **Unknown number** will be displayed instead of the name. If the number is suppressed, **Anonymous** will be displayed.)

- ▶ Tap on Read if you want to read the text message now.
The **TEXT** window opens. You can then read the text message.



Note: The navigation system will also read out the text to you when the window is opened. Reading out text messages is not possible in all languages however.

- ▶ Tap on Cancel if you want to read the message later.



Note: You can also choose not to have incoming text messages announced immediately. (Refer to "Settings" on page 125)

You can however open the list of received text messages at any time to check whether you have received any new text messages. (Refer to "Opening the mailbox" on page 124)

13.4 Making a call

With the hands-free module you can make a call in various ways:

13.4.1 Making a call with the voice commands function

It is particularly convenient to make a call with the voice commands function.

1. In the **HANDSFREE MODULE** window activate the mobile phone which you want to use to make the call. (Refer to "Activating a mobile phone" on page 116)

2. In the **HANDSFREE MODULE** window tap on Voice Command.

- or -

In the **NAVIGATION** window, in the map and if applicable in the **HANDSFREE MODULE** window move your hand briefly near to the screen of the navigation device. As soon as you take your hand away from the screen again you will hear a single prompt tone.

- ▶ Then say "Call".

The **VOICE COMMAND** window opens.

Specifying a phone number

3. Say "Telephone Number".

Say the number that you want to call.



Note: You have to say each number separately but you can say the numbers in blocks. For example, say "nine-four-three-three" for the number block 9433.

4. Wait for the numbers you said to appear.

Repeat steps 3 to 4 until the complete phone number is shown on the display. Say "Correction" if the last number you said was not understood correctly.

5. Say "Call".

The phone number will be dialled.

Calling a contact from the phone book

3. Say "Phone Book".

4. Say the name of the contact you want to call.

If several entries are recognised as matching this name, a list with these entries will appear.

- ▶ Say the number in front of the contact that you want to call.
If several phone numbers are saved for this contact, a list with these numbers will appear.
- ▶ Say the number in front of the phone number that you want to call.
The connection will be established.



Note: The **Voice Command** function is not available for every language. If it is not available, the **HANDSFREE MODULE** window will not show the Voice Command button but the Settings buttons.

13.4.2 Dialling a telephone number

1. In the **HANDSFREE MODULE** window activate the mobile phone which you want to use to make the call. (Refer to "Activating a mobile phone" on page 116)
2. Tap in the **HANDSFREE MODULE** window on the Keyboard button.
The **TELEPHONE NUMBER** window opens.
3. Enter the desired telephone number.
4. Tap on the Call button.

13.4.3 Dialling a Speed Call number

A total of 4 speed call buttons are available. These buttons can be configured separately for each paired mobile phone.

1. In the **HANDSFREE MODULE** window activate the mobile phone which you want to use to make the call. (Refer to "Activating a mobile phone" on page 116)
2. Tap in the **HANDSFREE MODULE** window on the corresponding Speed Call button.



Note: If the selected speed call button has not been configured yet, it will be labelled with just three dots (...). If you tap on the symbol, the **MODIFY PRESET** window will open. (Refer to "Preset" on page 125)

13.4.4 Calling a contact from the phone book

You can select numbers from the phone book of the active telephone.

1. In the **HANDSFREE MODULE** window activate the mobile phone which you want to use to make the call. (Refer to "Activating a mobile phone" on page 116)
2. In the **HANDSFREE MODULE** window tap on Phone Book.

- ▶ If the phone book of the active phone was not yet imported, the import will be started now. (Refer to "Import Phone Book" on page 117)
3. Select from the phone book the contact you want to call.
The **SELECTED PHONE BOOK ENTRY** window opens. It shows all the phone numbers and addresses which have been saved for the selected contact.
4. Tap on the  (**Call**) button alongside the phone number you want to dial.

13.4.5 Calling most recently dialed, received or missed numbers

The **RECENT CALLS** list contains outgoing, received and unanswered calls on the active telephone.



Note: Incoming and unanswered calls can be dialed only if the caller's number was transmitted.

1. In the **HANDSFREE MODULE** window tap on Recent Calls.
 - ▶ If the recent calls on the active phone were not yet imported, the import will be started now; refer to "Import recent calls" on page 118.

The **RECENT CALLS** list opens. The entries are sorted chronologically; the symbols to the right of the entry indicate the type of call:



(Missed calls)



(Incoming calls)



(Outgoing calls)

2. Tap on the entry you want.



Note: The **RECENT CALLS** list is available to the hands-free module only for as long as the hands-free module is connected to the mobile phone. It is updated automatically each time it is opened.

13.4.6 Transferring a call from your mobile telephone

The navigation device takes calls automatically from the mobile phone as soon as a Bluetooth connection is established between the two devices.

13.5 During a call

You are calling using the hands-free module. The **CALL IN PROGRESS** window is open.

13.5.1 Moving the navigation application to the foreground

You can move the navigation application to the foreground at any time. In this way you can have the map with the navigation instructions in the foreground during a call when the navigation device is in the process of navigating.

- ▶ Tap on  (Start) > Navigation.

While a call is in progress, the  (Call in Progress) symbol is visible in the top right corner of the display. The number indicates which of the connected phones is being used to make the call (here: "Phone 1").

- ▶ Tap on  (Start) > Phone to open the **CALL IN PROGRESS** window again.

13.5.2 Entering numbers

You can enter numbers during a call. This may be the case, for example, if a further connection via a telephone system is necessary.

1. Tap on Keyboard.
2. Enter the desired numbers.
3. Tap on  (Back) in order to open the **CALL IN PROGRESS** window.

13.5.3 Muting the microphone

During the call, you can mute the microphone so that you can talk to someone without the interlocutor hearing.

- ▶ In the **CALL IN PROGRESS** window, tap on  (Muting) to switch off the microphone.

The person on the other end of the line can no longer hear you. The modified symbol on the button indicates this.

- ▶ Tap on  (Muting) to switch the microphone on again.

13.5.4 Transferring a call to the mobile phone

- ▶ In the **CALL IN PROGRESS** window, tap on Options > Use Mobile Phone.

You can now continue the call from your mobile phone.

13.5.5 Ending the call

- ▶ Tap in the **CALL IN PROGRESS** window on the Hang up button in order to end the call.

13.6 Useful functions

13.6.1 Navigating to a contact from the phone book

You can also use the address of a contact in the phone book of the active telephone as a destination for the navigation system.

1. In the **HANDSFREE MODULE** window tap on Phone Book.
2. Select from the phone book the contact you want to navigate to. The **SELECTED PHONE BOOK ENTRY** window opens. It shows up to two addresses and up to four phone numbers which have been saved for the selected contact.
3. Tap on Start Navigation.
If more than one address is available for the selected contact, all the addresses will be shown.

- ▶ Tap on the address to which you want to navigate.



You can also select addresses from the phone book in the navigation software to act as destinations. For more details refer to the chapter "Imported Addresses from the phone book" on page 43.

13.6.2 Opening the mailbox

You can read text messages from the mailbox of the active telephone.



Note: The number of SMS that can be imported from the mobile phone is limited to 15.

1. In the **HANDSFREE MODULE** window, tap on Options > Text Inbox. The **TEXT INBOX** list opens. The entries are sorted in chronological order. The symbol to the right of each entry indicates whether the text message has been opened at least once:



(Unopened text message)



(Opened text message)

2. Tap on the entry you want.



Note: The **TEXT INBOX** list is available to the hands-free module only for as long as the hands-free module is connected to the mobile phone. It is updated automatically each time it is opened.

13.7 Configuring the hands-free function

The hands-free module contains a number of settings that can be individually configured.

13.7.1 Preset

The hands-free module of the navigation device contains four Speed Call buttons that can be individually configured.

1. In the **HANDSFREE MODULE** window, tap on Options > Modify Preset.
The **PRESET** window opens.
2. Tap on the  (Edit) button to the right of the Speed Call you want to define.
The **MODIFY PRESET** window opens.

Entering a new Speed Call number or editing an existing Speed Call number

3. Tap on the  (Edit) button.
4. Enter the name and the number for the selected Speed Call button or edit the existing name and number.
5. Tap on OK.

Adopting a number from the phone book of the mobile phone

3. Tap on the  (From the phone book) button. This button is deactivated when there is no connection to a mobile phone.
4. Select the contact which you want to adopt for the Speed Call.
The **SELECT PHONE NUMBER** window opens. It shows all the phone numbers saved for the selected contact.
5. Tap on the phone number you want to use for the Speed Call.

Deleting a Speed Call number

3. Tap on the  (Delete) button.
4. Confirm that you want to delete the Speed Call number.
The **PRESET** window opens again. No phone numbers and no name exist any longer for the selected Speed Call button.

13.7.2 Settings

In the **SETTINGS** window you can configure the settings for the phone functions of the hands-free module.

- ▶ In the **HANDSFREE MODULE** window, tap on Options > Settings.
The **SETTINGS** window opens.

Volume of the Phone Call: The volume of the phone call can be controlled independently of the volume of the navigation application.



Note: During a phone call the volume of the call can be regulated on the radio.

Volume of the Ring Tone: The volume of the ring tone can be controlled independently of the volume of the navigation application.

Info about New Texts: Select whether you want incoming text messages to be announced (Yes or No).

Bluetooth Function: Select whether you want to activate the Bluetooth function (Yes or No). The hands-free module cannot connect to a mobile phone or headset if the Bluetooth function is deactivated.

Others May Connect: Select whether other devices should be able to initiate a connection (Yes or No).

Discoverable by Others: Select whether other Bluetooth-capable devices (in particular mobile phones) should be able to detect the navigation device (Yes or No).

Reconnect Automatically: Select whether the connection to the last connected phone is to be restored automatically (Yes or No) as soon it comes within range again.

Sort phone book by: Select the column to be used for sorting the phone book (First Names or Last Names). This setting applies only to the phone book display in the navigation device.

Autoplay: Select whether you want audio files of a connected Bluetooth-capable device to be played back via the media player of the navigation system when the play-back function on the connected device is started (Yes or No).



For information about configuring the settings in this window refer to "Configuring the Navigation System" on page 127.



Note: In order for the last connection to be restored without further questioning, the navigation device must be saved in your mobile phone as "authorised" or "authorised device" (the exact wording can vary from manufacturer to manufacturer).



Note: The Discoverable by Others and Others May Connect settings are effective only when the Bluetooth function is activated.

A Bluetooth connection can be initiated from the mobile phone only when Yes is selected for both settings.

14 Configuring the Navigation System

The **SETTINGS** window is the starting point for customising the navigation system to match your personal preferences.

Settings can be accessed via the options in the **NAVIGATION** window and via the options in many windows of the navigation application.

- ▶ Tap on Options > Settings.



The **SETTINGS** window of the navigation application has several buttons: Current Route Profile., Navigation, Map Display and General.

- ▶ Tap on a button to open the corresponding settings window.





For details of how to select and configure a route profile refer to the chapter "Route profiles" on page 70.

The settings of the individual windows are split over various screens.

You can toggle between them with the  (To the Left) and  (To the Right) buttons.

Some settings can have only one of two values. These settings can be recognised by the  (Toggle) button. All possible values are visible. The currently valid value is highlighted (green).

- ▶ Tap on  (Toggle) in order to switch between the possible values.

Some settings can adopt many different values. These settings can be recognised by the  (List) button. The current value is visible.

1. Tap on  (List).
A list with all possible values opens. The currently valid value is marked.
2. Tap on the value you want. It is now marked.
3. Tap on OK.
The list will close. The new value is indicated.

For each setting there is a  (Help) button. When you tap on it you will see an exact definition of the setting in question.

You can close the settings windows in two ways:

- ▶ Tap on OK.
Any changes you have made will be adopted.
- ▶ Tap on Cancel.
Any changes you have made will not be adopted.

15 Appendix

15.1 Technical data of the navigation device

Dimensions		137 x 83 x 15,3 mm
Weight		190 g
Operating conditions	Operating temperature	-10°C to 70°C (14°F to 158°F)
	Storage temperature	-30°C to 80°C (-22°F to 176°F)
	Humidity	0% to 90%, non-precipitating
CPU		STM Cartesio 2064 (520MHz)
Operating system		Microsoft Windows CE
Display		5" LCD colour display with resistive touch-panel, 300 cd/m ² , 300:1 480 x 272 pixel (WQVGA)
Memory	RAM	128 MB
	Flash	4 GB
GPS		Yes (STM STA5630, ST-AGPS) Built-in antenna
TMC		Yes
Device keys		1 (<i>On/Off</i>)
I/O	Keyboard	Software keyboard
	Loudspeaker	Yes
	Memory card	microSD
	USB	1 x USB 2.0
	Bluetooth	Integrated With echo suppression
Power supply		Via the car cradle
Rechargeable battery	Type	LilonPo / Lilon, 1400 mAh
Charging	Electronic	Integrated

15.2 NAVIGON Licensing Policy

§ 1 Scope of Regulations

This Agreement regulates the relations between the user and NAVIGON AG, Schottmuellerstrasse 20 A, 20251 Hamburg, developer and proprietor of the exclusive utilisation rights to the NAVIGON software ("Software") as specified in the order. The subject matter of this Agreement is copyright interests.

§ 2 Extent of Use

- (1) NAVIGON grants the user the non-exclusive right, unlimited by time and location, to utilise the Software at a utilisation volume as specified in the order. The licensing includes the right to install and use the Software in accordance with the documentation and pursuant to these regulations.
- (2) NAVIGON expressly informs the user that complete utilisation of the Software is not possible until after proper registration.
- (3) The user must ensure that the above mentioned restricted utilisation rights are complied with.
- (4) Any kind of use which goes beyond the framework as stipulated in the Agreement requires the written consent of NAVIGON. In the event that such utilisation should be exploited without NAVIGON's consent, NAVIGON shall charge the amount accruing for this extended utilisation in accordance with the valid price list at the time. NAVIGON shall reserve the right to assert further reaching claims for compensation of damages. The user shall have the right to prove lower damages.
- (5) All the above mentioned utilisation rights shall only be transferred to the user after full and final payment of the license fee.

§ 3 Copyright and Protection Rights

- (1) The user acknowledges the copyrights of NAVIGON and therewith its exclusive utilisation and exploitation rights to the Software. Exclusive utilisation and exploitation rights also exist with regard to extended development of the Software or amendments thereto, which NAVIGON has created for the user compliant with the order.

- (2) Any kind of non explicitly authorised copying of the Software in its entirety or partially, any kind of non expressly authorised passing on of the Software and development of similar Software or segments of such Software or utilisation of the contractual Software as a master template shall in particular be deemed to be judicially and contractually prohibited.
- (3) The user acknowledges the imprint, trademark, trade name and patent rights of NAVIGON to the Software and the relevant appending documentation. The user is forbidden to remove, change or in any other way camouflage the copyright notices and identifications pertaining to existing protection rights.

§ 4 Passing on the Software

- (1) The user is permitted to sell or give away the Software and the user manual or any other accompanying materials on a permanent basis to third parties, under the proviso that the acquiring third party agrees that the contractual terms and conditions at hand shall henceforth also be imposed on it.
- (2) In the event of passing on the Software, the user shall hand over to the new user all copies of the program, including possible back-up copies made, or destroy the copies not handed over. As a result of passing on the Software, the former user's utilisation rights to the program shall extinguish.
- (3) The user is permitted to sell or give away the Software and the user manual or any other accompanying materials to third parties on a temporary basis, if this is not done within the framework of leasing or renting out for gainful purposes, under the proviso that the acquiring third party agrees that the contractual terms and conditions at hand shall henceforth also be imposed on it. For the period of assignment of the Software to third parties, the assigning user shall have no right to any kind of utilization of the program. For the period of assignment of the Software to third parties, the assigning user shall have no right to any kind of utilisation of the program. Renting out or granting a lease for gainful purposes shall be prohibited.
- (4) The user may not assign the Software to third parties if there should be any justified suspicion that such third party could violate the contractual terms and conditions, especially by making unlawful copies.

§ 5 Reproduction Rights and Access Security

- (1) The user may reproduce the Software if the respective copying should be necessary for operation. Necessary reproduction shall be deemed to be the installation of the program from the original data carrier to the bulk memory of the hardware used as well as loading of the program into random access memory.
- (2) Furthermore, the user is permitted to make copies for back-up purposes. However, fundamentally, only one single back-up copy may be made for safekeeping. The back-up copy has to be identified as such.
- (3) If regular copying of the complete database, including computer programs, is indispensable for reasons of data security or to ensure speedy reactivation of the computer system after a total crash, then the user is allowed to make back-up copies in the number specifically required. The data carriers used in this case must be marked accordingly. The back-up copies may only be used for purely archive-related purposes.
- (4) Further reproductions, which also include release of the program code on a printer as well as photocopying of the manual, may not be made by the user. Any additional manuals required by employees have to be obtained from NAVIGON.

§ 6 Multiple Deployment and Network Integration

- (1) The user may use the Software on any hardware available to it. However, in the event that the user should replace the hardware, it is obliged to delete the Software from the hardware utilised up till then. Any isochronous storage, keeping in stock or operation on more than only one hardware unit is not permissible.
- (2) The deployment of the entrusted Software within a network or any other multiple workstation computer system is not permissible if thereby the possibility of simultaneous multiple usage should be facilitated. Should the user select to use the Software within network operations or any other multiple workstation computer system, the user is obliged to abstain from simultaneous multiple use by integration of access protection devices or to compensate NAVIGON by payment of special network license fees to an amount calculated on the basis of the number of users linked up with the computer system. The user shall be informed immediately by NAVIGON with regard to network license fees to be raised in each individual case as soon as the user has informed NAVIGON in writing of the intended network integration and the number of integrated users. The implementation into such kind of network or multiple workstation computer system shall only be permissible after full and final payment of the network licensing fees.

§ 7 Third Party Software

The Software contains third party software products which have been integrated into the contractual Software or supplied together with the contractual Software. NAVIGON fundamentally only awards such rights which are necessary for general use of the programs as components of the contractual Software and which NAVIGON is authorised to grant. No modification rights or further processing rights are incorporated therein.

§ 8 Decompiling and Amendment of Programs

The user is forbidden to retranslate the entrusted program code into other code configurations (decompiling) as well as any other kind of inverted development of the diverse manufacturing phases of the Software (reverse engineering) or to carry out program amendments of any kind unless such actions should serve purposes of eliminating serious defects, especially such defects which can not be avoided by organisational or any other reasonable measure of remedy. Copyright markings, serial numbers as well as other characteristics serving purposes of identification of the program may not be eliminated or changed. Any removal of copy protection or similar protective routine measures is prohibited without the knowledge and co-operation of NAVIGON.

§ 9 Final Clauses

- (1) In the event that any provision contained in this License Policy should be determined to be invalid or become invalid, the effectiveness of the other regulations shall not be affected thereby. The said invalid provision shall be replaced by a valid provision within the context of the remaining contractual interpretation, which comes as close as possible to the intended economical purpose of such invalid provision.
- (2) Amendments and supplements to these regulations have to be in the written form and have to be expressly identified as such. Verbal ancillary agreements shall be deemed to be ineffective. This requirement of written form may only be renounced by written agreement.
- (3) If legally permissible, the Parties agree that the laws of the Federal Republic of Germany shall apply to all legal relations arising from these contractual relations, under exclusion of UN Purchase Law.

- (4) If the user should be a businessman within the meaning of the Commercial Code, legal entity under public law or special assets under public law, all disputes which may arise in connection with the accomplishment of these contractual regulations shall fall under the jurisdiction of Hamburg.

15.3 Declaration of Conformity

NAVIGON AG declares herewith that the devices described in the manual are in conformance with the basic requirements and other relevant provisions of EU Directive 1999/5/EC and the R&TTE Directive.

The declaration of conformity can be viewed on the Internet at www.navigon.com/ce-erklaerung.

16 Troubleshooting

In this chapter you will find solutions to problems which may arise during use of the navigation system.

This list does not claim to be complete. Answers to many other questions can be found on the NAVIGON website. (Refer to "Questions about the product" on page 9)

I have connected a charger to the navigation device. A connection to a computer is shown on the screen.

- or -

I have connected the navigation device to a computer but it is not detected as a removable disc.

The USB connector of the charger is not fully inserted in the case.

- or -

The USB connector is not connected correctly.

1. Unplug the connector.

The navigation device will carry out a new start. Wait for the navigation software to be reloaded.

2. Insert the USB connector from the charger into the corresponding socket of the navigation device swiftly as far as it will go. (Refer to "Description of the navigation device" on page 10)

My navigation device makes no response any longer, the screen is frozen.

Perform a reset.

- ▶ Use a thin object to press the Reset key. (Refer to "Description of the navigation device" on page 10)

The software will be restarted. Your settings and your saved destinations and routes will be retained.

It seems to me that the battery of my navigation device becomes flat relatively quickly when the device is not connected to an external power supply.



Some settings can be configured so that energy consumption is minimised.

1. In the **NAVIGATION** window tap on Options > Settings > General.
2. Set the values for Brightness Day and Brightness Night as low as possible.
3. Tap on OK.
4. Tap on  (Back).

The **NAVIGATION** window is now open again.

I have inserted a memory card but it is not detected. I am unable to play the music or view the pictures on the memory card.

Try the following:

1. Make sure that the memory card is correctly inserted in the device.
2. Press the  (On/Off) key and keep it pressed until the device switches off (approx. 5 seconds).
3. Wait several seconds.
4. Press the  (On/Off) key and keep it pressed until the device switches on.

If the card is not detected again, it may be defective.



Note: Use only accessories that are recommended by NAVIGON expressly for your navigation system. NAVIGON AG accepts no liability for errors or damages resulting from the use of other accessories.

For suitable accessories go to www.navigon.com or your authorised dealer.

17 Index

A

Activate 116

B

Block 85, 87

Bluetooth

 Activate 116

 Connect 115

 Pairing 113

Bluetooth see Handsfree Module

Bluetooth Connection 113

C

Call

 Dial Number 121

 Phone Book 121

 Preset 121

 Recent Calls 122

 Voice Command 120

Call in Progress

 Enter numerals 123

 Hang up 124

 Muting 123

 Show Map 123

 Use handsfree 122

 Use Mobile Phone 123

Compass 22

Configuration 127

Connect 115

Conventions followed in this manual 8

Coolant Temperature 97

Current Position

 Save 85

D

Data entry 27

Destination

 Direct Access 40

 Enter Coordinates 35

 Favourites 41

 From Map 44

 From the phone book 124

 Home Address 44, 47

 Imported Addresses

 From the phone book 43, 124

 Outlook / Internet 42

 Last Destinations 42

 My Destinations 32

 New Destination 32

 POI 37

 Direct Access 40

 in a City 39

 Nationwide 38

 Nearby 37

 Save 47

 Start Navigation 45

 Take Me Home 44, 47

 Turn-by-Turn List 45

 Voice Command 33

Direct Help 84

Door monitoring 95

E

Energy 14, 23, 134

Enter Coordinates 35

Entering data 27

F

Favourites 41, 46

G

Gauges

 Coolant Temperature 97

 Outside Temperature 97

 RPM Gauge 97

GPS

 Faulty reception 30

 Initialise 31

 Signals 15

 Symbols 22

GPS Status 85

H

Handsfree Module	
Activate	116
Bluetooth Connection	113
Call	120
Call in Progress	123
Connect	115
Delete Device	117
Dial Number	121
Enter numerals	123
Hang up	124
Import Phone Book	117
Import recent calls	118
Incoming Call	119
Incoming text message	119
Muting	123
Open	111
Pairing	113
Phone Book	121
Preset	121, 125
Recent Calls	122
Settings	125
Show Map	123
Symbols	24
Text Inbox	124
Use handsfree	122
Use Mobile Phone	123
Voice Command	120
Home Address	
Edit	48
Home Address	44, 47
Hotline	9

I

Imported Addresses	
From the phone book	43
Outlook / Internet	42

K

Keyboard	26
----------------	----

L

Last Destinations	42, 46
Logbook	25, 92
Low fuel warning	93

M

Manual	
Conventions	8
Symbols	8
Manual	20
Map	
Destination search	68
Offroad	67
Pedestrian	65
Preview	58
Reality View	64
Standard	57
Track	67
Vehicle	60
Media	
Media Player	101
Media Source	103
Sound	106
TP	106
Traffic Information	106
Radio	98
Sound	106
TP	106
Traffic Information	106
Media	25
Media Player	
Media Source	103
Sound	106
TP	106
Traffic Information	106
Media Player	101
Memory card	14, 134
Menu	28
Muting	25
My Destinations	32
My POIs	73
MyPOIs	73
MyRoutes	45, 53

N

Navigation	
Block	85, 87
MyRoutes	45, 53
No GPS	46, 54
Route Profile	45, 53
Start	45, 53
Start Navigation	46, 54
Turn-by-Turn List	45, 53
Unblock	86
Navigation Application	
Start	31
Navigation system	
Description	10
Energy	14
Installation	12
Memory card	14
No TMC	14
Scope of Delivery	9
Start	15
Technical data	128
NAVIGON Sightseeing	81
Nearby	78
New Destination	32

O

OPS	94
Optical parking system	94
Options	20, 28, 54
Outside Temperature	97

P

Pairing	113
Parking	
Last Destination	78
Parking Close to Destination	77
Pedestrian mode	77
Parking assistant	94
Password Lock	20
Phone	see Handsfree Module
Phone Book	
Import Phone Book	117
Refresh	118

Phone Book	121
Picture Viewer	108
Pictures	108
POI	
Direct Access	40
in a City	39
Nationwide	38
NAVIGON Sightseeing	81
Nearby	37
POI on Your Route	79
Preset	125
Preview TMC	88

R

Radio	
Sound	106
TP	106
Traffic Information	106
Radio	25, 98
Reality View	64
Recalculate Route	92
Recent Calls	
Import recent calls	118
Recent Calls	122
Reversing assistance	94
Route Planning	49
Route points	
Add	50
Delete	50
Order	50
Starting Point	50
Route Profile	45, 53, 70
Routes	
Load	51
Manage	51
Route points	50
Route Profile	53
Save	51
Show	52
Simulation	52
Start Navigation	53
Starting Point	49
Turn-by-Turn List	53
Routes and Tracks	
Load	51
Planning	49

Routes and Tracks	49
RPM Gauge.....	97

S

Safety information.....	10
Scope of Delivery	9
Service	9
Settings	
Configuration.....	127
Handsfree Module.....	125
Volume.....	64
Settings Handsfree Module	
Bluetooth Connection.....	113
Delete Device.....	117
Preset	125
Sightseeing Tours.....	83
Simulation	
Exit.....	52
Start.....	52
Software keyboard.....	26
Support.....	9
Symbols	
Handsfree Module.....	24
Logbook.....	25
Media.....	25
Muting.....	25
Radio.....	25
TMC.....	23
TP.....	24
Traffic Information	23, 24
Symbols used in this manual	8

T

Take Me Home.....	44, 47
Technical data.....	128
Text Inbox	124
TMC	
Preview TMC	88
Recalculate Route.....	92
Show.....	90

Symbols.....	23
Tuning Mode.....	92
TMC Settings	
Recalculate Route	92
TMC.....	91
Traffic Information.....	91
Tuning Mode.....	92
TP	
Radio.....	106
Symbols.....	24
Track	
Load.....	51
Record Track.....	22, 76
Trade marks.....	9
Traffic Information	
Preview TMC.....	88
Radio.....	106
Recalculate Route	92
Show.....	90
Symbols.....	23, 24
Tuning Mode.....	92
Trip Computer	96
Troubleshooting	133
Tuning Mode.....	92
Turn-by-Turn List	
Block.....	87
Show	45, 53, 86

U

Unblock.....	86
Use Voice Command	28

V

Voice Command.....	28, 33, 120
Volume.....	64

W

Warranty	8
----------------	---