



Instruction Bulletin
52012-008-01
March 1997
Price \$10.00

ALTIVAR® 18

**Adjustable Speed Drive Controllers
for Asynchronous Motors**

User's Manual

Obsolete

DANGER

HAZARDOUS VOLTAGE.

- Read and understand this bulletin in its entirety before installing or operating ALTIVAR 18 drive controllers. Installation, adjustment, repair, and maintenance of these drive controllers must be performed by qualified personnel.
- Disconnect all power before servicing drive controller. WAIT ONE MINUTE until DC bus capacitors discharge, then measure DC bus capacitor voltage (see pages 39 and 40) to verify DC voltage is less than 45 V. The DC bus LED is not an accurate indication of the absence of DC bus voltage.
- DO NOT short across DC bus capacitors or touch unshielded components or terminal strip screw connections with voltage present.
- Install all covers before applying power or starting and stopping the drive controller.
- User is responsible for conforming to all applicable code requirements with respect to grounding all equipment. For drive controller grounding points, refer to Figure 5 on page 11.
- Many parts in this drive controller, including printed wiring boards, operate at line voltage. DO NOT TOUCH. Use only electrically insulated tools.

Before servicing drive controller:

- Disconnect all power.
- Place a "DO NOT TURN ON" label on drive controller disconnect.
- Lock disconnect in open position.

Failure to follow these instructions will result in death or serious injury.

ALTIVAR is a registered trademark of Square D.

© 1997 Schneider S.A. All rights reserved. This document may not be copied in whole or in part, or transferred to any other media, without the written permission of Schneider S.A.

Electrical equipment should be serviced only by qualified electrical maintenance personnel. No responsibility is assumed by Schneider S.A. for any consequences arising out of the use of this material.

TABLE OF CONTENTS

RECEIVING AND PRELIMINARY INSPECTION	1
STORING AND SHIPPING	1
TECHNICAL CHARACTERISTICS	2
SPECIFICATIONS	4
DIMENSIONS	5
ATV18 FAN FLOW RATES	5
INSTALLATION PRECAUTIONS	6
MOUNTING IN TYPE 12 (IP54) METAL ENCLOSURE	7
Calculating Enclosure Size	7
Ventilation	8
ELECTROMAGNETIC COMPATIBILITY (EMC)	9
Installation precautions for meeting EN55011 Class A	9
General rules	9
Installation Plan	9
WIRING	11
General Wiring Practices	12
Branch Circuit Connections	12
Output Wiring Precautions	13
Grounding	14
Power Terminals	15
Equipment Ground Terminal	16
Control Terminals	17
USING THE LOGIC INPUTS	18
USING THE ANALOG INPUTS	20
FUNCTION COMPATIBILITY	21
WIRING DIAGRAM	22
FAULT RELAY	22
RECOMMENDED FUSES	23
THERMAL OVERLOAD PROTECTION	24
AVAILABLE TORQUE	25
FACTORY SETTINGS	26
USING THE DISPLAY KEYPAD	27
PARAMETER SUMMARY	28

DRIVE CONTROLLER SET UP	30
Level 1 Parameters	30
Level 2 Parameters	33
MAINTENANCE	38
PRECAUTIONS	38
Procedure 1: Bus Voltage Measurement	39
Drive Controllers ATV18•••M2 and ATV18U18N4 to D12N4	39
Drive Controllers ATV18D16N4 and ATV18D23N4	40
Procedure 2: Checking Supply Voltage	41
Procedure 3: Checking the Peripheral Equipment	41
Fault Storage	42
FAULT CODES	42

RECEIVING AND PRELIMINARY INSPECTION

Before installing the ALTIVAR® 18 (ATV18) drive controller, read this manual and follow all precautions:

- Before removing the drive controller from its packing material, verify it is not damaged from shipping. Any damage to the packing carton usually indicates improper handling. If any damage is found, notify the carrier and your Square D representative.
- After removing the drive controller from its packaging, visually inspect the exterior for shipping damage. If any shipping damage is found, notify the carrier and your sales representative.
- Verify that the drive controller nameplate and label conform to the packing slip and corresponding purchase order.

CAUTION

EQUIPMENT DAMAGE HAZARD

Do not operate or install any drive controller that appears damaged.

Failure to follow this instruction can result in injury or equipment damage.

STORING AND SHIPPING

If the drive controller is not being immediately installed, store it in a clean, dry area where the ambient temperature is between -25 and +65 °C (-13 to +149 °F). If the drive controller must be shipped to another location, use the original shipping material and carton to protect the drive controller.

TECHNICAL CHARACTERISTICS

Table 1: Technical Characteristics: 200 V -15% to 240 V +10%,
 50/60Hz ± 5%, Single-Phase Input, Three-Phase Output

Drive Controller Catalog Number	Input Line Current ^[1]		Motor Power		Rated Output Current (In)	Transient Output Current ^[2]	Total Dissipated Power @ Rated Load	Short Circuit Rating
	Single Phase		kW	hp				
	200 V	240 V						
A	A			A	A	W	A rms sym.	
ATV18U09M2	4.4	3.9	0.37	0.5	2.1	3.2	23	1,000
ATV18U18M2	7.6	6.8	0.75	1	3.6	5.4	39	1,000
ATV18U29M2	13.9	12.4	1.5	2	6.8	10.2	60	1,000
ATV18U41M2	19.4	17.4	2.2	3	9.6	14.4	78	1,000

[1] Values correspond to the amount absorbed by drive controllers supplied by mains with fault capacity equal to short-circuit rating indicated in table and under nominal conditions of load and speed of the associated motor, without additional inductance.

[2] For 60 seconds.

Table 2: Technical Characteristics: 200 -15% to 230 V +10%,
 50/60 Hz ± 5%, Three-Phase input, Three-Phase Output

Drive Controller Catalog Number	Input Line Current ^[1]		Motor Power		Rated Output Current (In)	Transient Output Current ^[2]	Total Dissipated Power @ Rated Load	Short Circuit Rating
	Three Phase		kW	hp				
	200 V	230 V						
A	A			A	A	W	A rms sym.	
ATV18U54M2	16.2	14.9	3	-	12.3	18.5	104	5,000
ATV18U72M2	20.4	18.8	4	5	16.4 ^[3]	24.6	141	5,000
ATV18U90M2	28.7	26.5	5.5	7.5	22 ^[3]	33	200	22,000
ATV18D12M2	38.4	35.3	7.5	10	28 ^[3]	42	264	22,000

[1] Values correspond to the amount absorbed by drive controllers supplied by mains with fault capacity equal to short-circuit rating indicated in table and under nominal conditions of load and speed of the associated motor, without additional inductance.

[2] For 60 seconds.

[3] Rated output currents shown are for switching frequencies of 2.2 to 4 kHz. If switching frequency is > 4 kHz and ≤ 8 kHz, derate output current by 5%. If switching frequency is > 8 kHz, derate output current by 10%. See page 37 for adjustment of switching frequency.

Table 3: Technical Characteristics: 380/220 V ^[1] -15% to 460/270 V ^[1] +10%, 50/60 Hz ± 5%, Three-Phase Input, Three-Phase Output

Drive Controller Catalog Number	Input Line Current ^[2] Three Phase		Motor Power		Rated Output Current (In) ^[4] A	Transient Output Current ^[3] A	Total Dissipated Power @ Rated Load W	Short Circuit Rating A rms sym.
	380 V A	460 V A	kW	hp				
ATV18U18N4	2.9	2.7	0.75	1	2.1	3.2	24	5,000
ATV18U29N4	5.1	4.8	1.5	2	3.7	5.6	34	5,000
ATV18U41N4	6.8	6.3	2.2	3	5.3	8	49	5,000
ATV18U54N4	9.8	8.4	3	-	7.1	10.7	69	5,000
ATV18U72N4	12.5	10.9	4	5	9.2	13.8	94	5,000
ATV18U90N4	16.9	15.3	5.5	7.5	11.8	17.7	135	22,000
ATV18D12N4	21.5	19.4	7.5	10	16	24	175	22,000
ATV18D16N4	31.8	28.7	11	15	22	33	261	22,000
ATV18D23N4	42.9	38.6	15	20	29.3	44	342	22,000

^[1] Suitable for use on neutral grounded systems only.

^[2] Values correspond to the amount absorbed by drive controllers supplied by mains with fault capacity equal to short-circuit rating indicated in table and under nominal conditions of load and speed of the associated motor, without additional inductance.

^[3] For 60 seconds.

^[4] Rated output currents shown are for switching frequencies of 2.2 to 4 kHz. If switching frequency is > 4 kHz and ≤ 8 kHz, derate output current by 5%. If switching frequency is > 8 kHz, derate output current by 10%. See page 37 for adjustment of switching frequency.

SPECIFICATIONS

Table 4: Specifications

Environment	
Degree of Protection	NEMA Open ^[1] IP31 without removal of grey tape from the top of the drive controller IP20 with removal of grey tape from the top of the drive controller
Resistance to vibrations	0.6 g from 10 to 50 Hz 2 g from 50 to 150 Hz
Pollution degree	Pollution degree 2 according to NEMA ICS-1 and IEC 664. Protect the drive controller against dust, corrosive gas, and falling liquid.
Maximum relative humidity	93% maximum, non-condensing and without dripping (provide heating system if there is condensation)
Maximum ambient temperature	Storage: -13 to +149 °F (-25 to +65 °C) Operation: +14 to +104 °F (-10 to +40 °C) without grey tape removed +14 to +122 °F (-10 to +50 °C) with grey tape removed
Altitude	Up to 3,300 ft (1,000 m) without derating; derate by 3% for each additional 3,300 ft (1,000 m)
Electrical Characteristics	
Input voltage	ATV18***M2, 1-phase: 200 V -15% to 240 V +10% ATV18***M2, 3-phase: 200 V -15% to 230 V +10% ATV18***N4: 380 V -15% to 460 V +10%
Input frequency	50/60 Hz ±5%
Input phases	ATV18U09M2 to U41M2: 1 ATV18U54M2 to D12M2: 3 ATV18***N4: 3
Output voltage	Maximum voltage equal to input voltage
Output frequency	0.5 to 320 Hz
Output phases	3
Max. transient current	150% of nominal drive controller current for 60 seconds
Braking torque	30% of nominal motor torque without dynamic braking (typical value). Up to 150% with optional dynamic braking resistor
Frequency resolution	Display: 0.1 Hz Analog inputs: 0.1 Hz for 100 Hz maximum
Switching frequency	Adjustable from 2.2 to 12 kHz
Drive controller protection	Galvanic isolation between power and control (power supplies, inputs, outputs) Protection against short circuits: <ul style="list-style-type: none"> • in available internal sources • between output phases • between output phases and ground for 7.5 to 20 hp drive controllers Thermal protection against overheating and overcurrents Undervoltage and overvoltage faults Overbraking fault
Motor protection	Protection integrated in the drive controller by I ² t calculation

^[1] Drive controller electrical creepages are designed for use in a pollution Degree 2 environment per NEMA ICS-1 and IEC 664.

DIMENSIONS

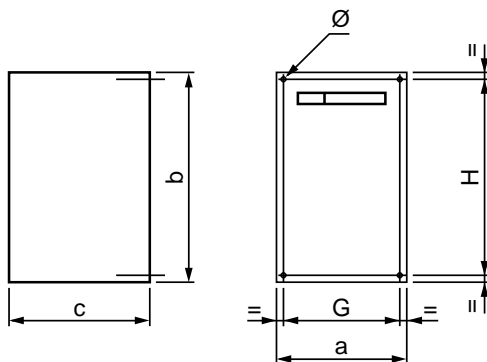

Figure 1: Altivar 18 Dimensions

Table 5: Dimensions

Catalog No.	a	b	c	Mounting		Ø	Weight
				G	H		
ATV18U09M2 ATV18U18M2	4.41 (112)	7.17 (182)	4.76 (121)	3.94 (100)	6.7 (170)	0.20 (5)	3.3 (1.5) 3.3 (1.5)
ATV18U29M2 ATV18U18N4 ATV18U29N4	5.87 (149)	7.24 (184)	6.18 (157)	5.39 (137)	6.77 (172)	0.20 (5)	4.6 (2.1) 4.4 (2.0) 4.6 (2.1)
ATV18U41M2 ATV18U54M2 ATV18U72M2 ATV18U41N4 ATV18U54N4 ATV18U72N4	7.28 (185)	8.46 (215)	6.22 (158)	6.73 (171)	7.95 (202)	0.24 (6)	6.2 (2.8) 7.3 (3.3) 7.3 (3.3) 6.8 (3.1) 7.3 (3.3) 7.3 (3.3)
ATV18U90M2 ATV18D12M2 ATV18U90N4 ATV18D12N4	8.27 (210)	11.81 (300)	6.69 (170)	7.48 (190)	11.02 (280)	0.28 (7)	17.2 (7.8) 17.2 (7.8) 17.6 (8.0) 17.6 (8.0)
ATV18D16N4 ATV18D23N4	9.65 (245)	15.35 (390)	7.48 (190)	8.86 (225)	14.57 (370)	0.40 (10)	26.4 (12.0) 26.4 (12.0)

Dimensions are in inches (millimeters). Weights are in pounds (kilograms).

ATV18 FAN FLOW RATES

Table 6: ATV18 Fan Flow Rates

Drive Controller	Fan Flow Rate	
ATV18 U09M2, U18M2, U18N4	Non-ventilated	
ATV18 U29M2, U29N4	8.8 CFM	0.25 m ³ /minute
ATV18 U41M2, U54M2, U72M2, U41N4, U54N4, U72N4	26.5 CFM	0.75 m ³ /minute
ATV18 U90M2, D12M2, U90N4, D12N4, D16N4, D23N4	45.9 CFM	1.3 m ³ /minute

INSTALLATION PRECAUTIONS

- The ATV18 drive controller is a NEMA Open device and must be installed in a suitable environment. The environment around the drive controller must not exceed pollution degree 2 requirements as defined in NEMA ICS-1 or IEC 664.
- When shipped the ATV18 has a protection rating of IP31 and can be operated in an ambient of up to 40 °C. When installing the drive controller in an enclosure with an ambient of up to 50 °C, remove the grey tape from the top of the drive controller. With the grey tape removed, the drive controller has a protection rating of IP20.
- Figure 2 shows the minimum clearances required around the drive controller for unobstructed airflow; above and below: ≥ 4 in (100 mm), sides: ≥ 2 in (50 mm). These clearances should not be used as minimum enclosure size for proper thermal dissipation.
- Mount the drive controller vertically. Avoid placing near any heat sources.
- Verify that the voltage and frequency characteristics of the input line match the drive controller nameplate rating.
- Installation of a disconnect switch between the input line and drive controller is recommended. Follow national and local codes.
- Overcurrent protection is required. Install line power fuses recommended in Table 10 on page 23 and Table 11 on page 23.
- Turn off all power before installing the drive controller. Place a “DO NOT TURN ON” label on the drive controller disconnect. Before proceeding with installation, lock the disconnect in the open position.

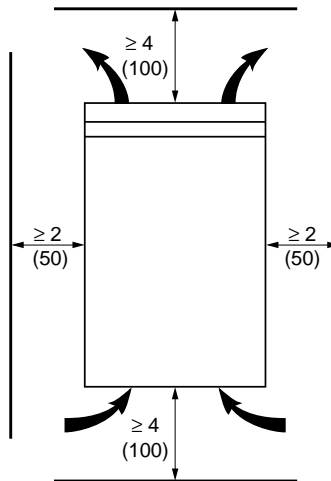

Dimensions are in inches (millimeters).

Figure 2: Minimum Clearances and Ventilation Flow

MOUNTING IN TYPE 12 (IP54) METAL ENCLOSURE

Calculating Enclosure Size

Below is the equation for calculating R_{th} ($^{\circ}\text{C}/\text{W}$), the maximum allowable thermal resistance of the enclosure:

$$R_{th} = \frac{T_i - T_o}{P}$$

T_i = Max. internal ambient temp. ($^{\circ}\text{C}$) around drive controller
 T_o = Max. external ambient temp. ($^{\circ}\text{C}$) around enclosure
 P = Total power dissipated in enclosure (W)

For the power dissipated by the drive controllers at rated load, see Tables 1 and 2 on page 2 and Table 3 on page 3.

Useful heat exchange surface area, S (in^2), of a wall-mounted enclosure generally consists of the sides, top, and front. The minimum surface area required for a drive controller enclosure is calculated as follows:

$$S = \frac{K}{R_{th}}$$

R_{th} = Thermal resistance of the enclosure (calculated previously)
 K = Thermal resistance per square inch of the enclosure
 K = 186 with enclosure fan
 K = 233 without enclosure fan

Consider the following points when sizing the enclosure:

- Use only metallic enclosures, since they have good thermal conduction.
- This procedure does not consider radiant or convected heat load from external sources. Do not install enclosures where external heat sources (such as direct sunlight) can add to enclosure heat load.
- If additional devices are present inside the enclosure, consider the heat load of the devices in the calculation.
- The actual useful area for convection cooling of the enclosure will vary depending upon the method of mounting. The method of mounting must allow for free air movement over all surfaces considered for convection cooling.

The following sample illustrates calculation of the enclosure size for an ATV18U72N4 (5 hp) drive controller mounted in a Type 12 enclosure.

- Maximum external temperature: $T_o = 25^{\circ}\text{C}$
- Power dissipated inside enclosure: $P = 94\text{ W}$
- Maximum internal temperature: $T_i = 40^{\circ}\text{C}$
- Thermal resistance per square inch of enclosure: $K = 186$

- Calculate maximum allowable thermal resistance, Rth:

$$R_{th} = \frac{40\text{ }^{\circ}\text{C} - 25\text{ }^{\circ}\text{C}}{94\text{ W}} = 0.16\text{ }^{\circ}\text{C/W}$$

- Calculate minimum useful heat exchange surface area, S:

$$S = \frac{186}{0.16} = 1162.5\text{ in}^2$$

Useful heat exchange surface area (S) of the proposed wall-mounted enclosure:

- Height: 24 in (610 mm)
- Width: 20 in (508 mm)
- Depth: 12 in (305 mm)

$$S = \begin{array}{ccc} \text{front area} & \text{top area} & \text{side area} \\ \downarrow & \downarrow & \downarrow \\ (24 \times 20) & + (20 \times 12) & + 2(24 \times 12) = 1296\text{ in}^2 \end{array}$$

If the selected enclosure does not provide the required surface area or does not meet application needs, consider the following:

- Use a larger enclosure.
- Add a passive heat exchanger to the enclosure.
- Add an air conditioning unit to the enclosure.

Ventilation

When mounting the drive controller inside a Type 12 or IP54 enclosure, follow these ventilation precautions:

- Observe minimum clearance distances shown in Figure 2 on page 6.
- Follow the installation precautions on page 6.
- A stirring fan with filter may be necessary to circulate the air inside the enclosure and prevent hot spots in the drive controller and to distribute the heat uniformly to surfaces used for convection cooling.
- If there is a possibility of condensation, keep the control supply switched on during periods when the motor is not running or install thermostatically controlled strip heaters.

ELECTROMAGNETIC COMPATIBILITY (EMC)

NOTE: This section focuses on applications requiring compliance to the European Community EMC directive. The Altivar 18 is considered to be a component. It is neither a machine nor a piece of equipment ready for use in accordance with the European Community directives (machinery directive or electromagnetic compatibility directive). It is the user's responsibility to ensure that the machine meets these standards.

Installation precautions for meeting EN55011 Class A

General rules

Ensure that the grounds of the drive controller, the motor, and the cable shields are at equal potential.

Use shielded cables with the shields tied to ground at both ends of the motor cable and the control cables. The ground connection to the shield must make contact with the complete circumference of the shield. As long as there is no discontinuity, this shielding can be achieved by using metallic conduit . Bonding at conduit fittings is required.

Installation Plan

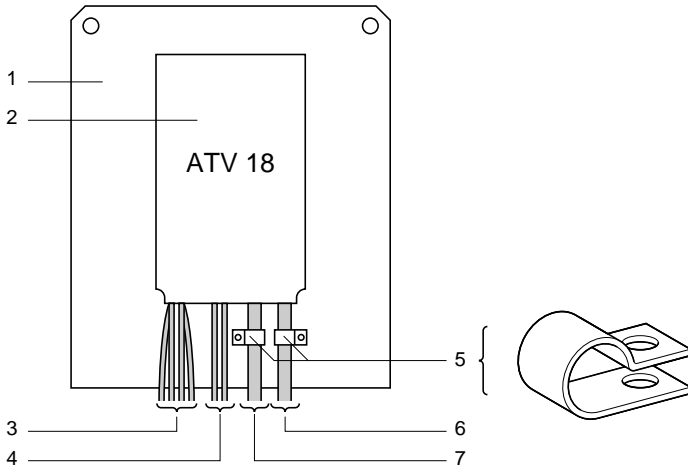

Figure 3: Installation Diagram

Description of parts in Figure 3:

1. A sheet metal plate, which is not painted, and has an anti-corrosion conductive treatment (ground plane). Painted sheet metal can be used on the condition that a good electrical contact is made between the support and fixation surfaces and 2 and 5.

Description of parts in Figure 3 (continued):

2. The ATV18 is mounted directly to the metal plate. Ensure that all four corner mounting points have good electrical contact with the metal plate.
3. Non-shielded input wire or cable, connected to the input inductors, if used. Maintain separation between input wiring and motor wiring as described in “General Wiring Practices” on page 12.
4. Non-shielded wire for the output of the fault relay contacts. Maintain separation between fault relay wiring and motor wiring as described in “General Wiring Practices” on page 12.
5. Fastening and grounding of the shields of cables 6 and 7 must be made as close to the drive controller as possible.
 - Strip the shields
 - Use straps with appropriate dimensions on the stripped portions of the shield for fastening to the sheet metal.
 - Clamps should be stainless steel.

The shields must be well clamped to the sheet metal in order to have good contact.

6. Shielded cable for connection to motor, with shield tied to ground at both ends. At the drive controller, the shield is connected to the E or G/E terminal on the far right of the power terminal strip. This shield must not be interrupted. If intermediate terminal blocks are used, they must be in EMC-shielded metallic boxes. The cable shield must have an ampacity greater than or equal to that of the ground conductor.
7. Shielded cable for connection to control/command. For applications requiring several conductors, a small wire size must be used (20 AWG or 0.5 mm²). The shield must be tied to ground at both ends. At the drive controller, the shield is connected to the E or G/E terminal on the far right of the power terminal strip. This shield must not be interrupted. If intermediate terminal blocks are used, they must be in EMC-shielded metallic boxes. Maintain separation between control/command wiring and motor wiring.

NOTE: Connection at equal potential of the grounds between the drive controller, motor, and cable shields does not preclude the connection of equipment ground conductors as required by national and local codes.

WIRING

To access the terminal blocks remove the two screws and remove the cover. When accessing the terminals, first perform the Bus Voltage Measurement Procedure on page 39. Figure 4 shows the location of the cover screws.

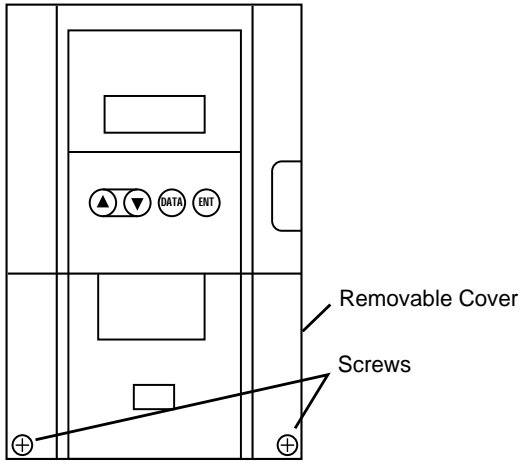

Figure 4: Accessing Terminal Strips

Figure 5 shows the location of the drive controller wiring terminals.

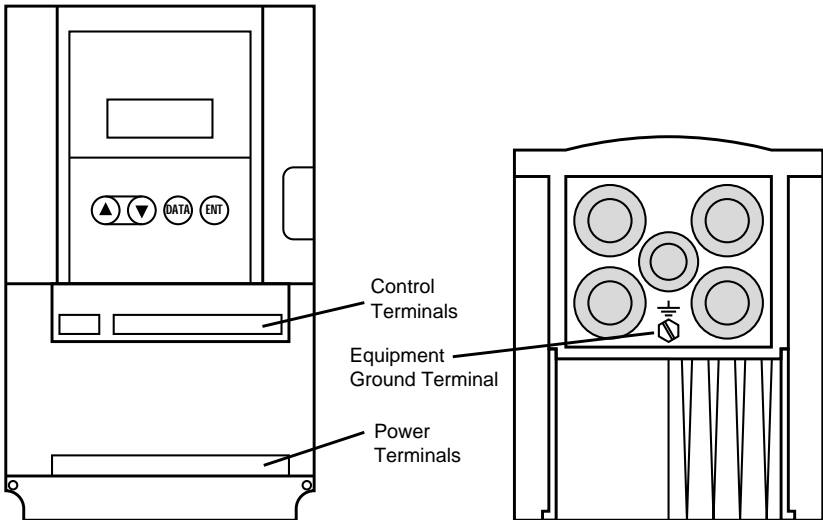

Figure 5: Wiring Terminals

General Wiring Practices

Good wiring practice requires the separation of control circuit wiring from all power (line) wiring. Power wiring to the motor must have the maximum possible separation from all other power wiring, whether from the same drive controller or other drive controllers; **do not run in the same conduit**. This separation reduces the possibility of coupling electrical transients from power circuits into control circuits or from motor power wiring into other power circuits.

CAUTION

EQUIPMENT DAMAGE HAZARD

Follow wiring practices described in this document in addition to those already required by the National Electrical Code and local electrical codes.

Failure to follow these instructions can result in injury or equipment damage.

Follow the practices below when wiring ALTIVAR 18 drive controllers:

- Use metallic conduit for all drive controller wiring. Do not run control and power wiring in the same conduit.
- Separate metallic conduits carrying power wiring or low-level control wiring by at least 3 in (7.62 cm).
- Separate non-metallic conduits or cable trays used to carry power wiring from metallic conduit carrying low-level control wiring by at least 12 in (30.5 cm).
- Whenever power and control wiring cross, the metallic conduits and non-metallic conduits or trays must cross at right angles.

Branch Circuit Connections

All branch circuit components and equipment (such as transformers, feeder cables, disconnect devices, and protective devices) must be rated for the maximum input current of the ALTIVAR 18 drive controller, not the motor full load current. The drive controller input current is stamped on the nameplate.

WARNING

OVERCURRENT PROTECTIVE DEVICES MUST BE PROPERLY COORDINATED

- To achieve published fault withstand current ratings, install the specified fuses listed on drive controller nameplate and in Table 10 and Table 11 on page 23.
- Do not connect drive controller to power feeder whose short circuit capacity exceeds drive controller withstand fault rating listed on drive controller nameplate.

Failure to follow these instructions can result in death, serious injury, or equipment damage.

Output Wiring Precautions

WARNING

DRIVE CONTROLLER DAMAGE

Drive controller will be damaged if input line voltage is applied to output terminals (U, V, W). Check power connections before energizing drive controller.

Failure to follow these instructions can result in death, serious injury, or equipment damage.

The drive controller is sensitive to the amount of capacitance (either phase-to-phase or phase-to-ground) present on the output power conductors. If excessive capacitance is present, the drive controller may trip on overcurrent.

Follow the guidelines below when selecting output cable:

- Cable type: the cable selected must have a low capacitance phase-to-phase and to ground. Do not use mineral-impregnated cable because it has a very high capacitance. Immersion of cables in water increases capacitance.
- Cable length: the longer the cable, the greater the capacitance. Cable lengths greater than 100 ft (30.5 m) may cause problems.
- Proximity to other output cables: because of the high frequency switching and increased capacitance, the drive controller may fault under some conditions.
- Do not use lightning arrestors on output of drive controller.

Wiring needs minimum inductance to protect the drive controller output from short circuits. Provide at least 19.7 in (50 cm) of cable at drive controller output (U, V, W).

CAUTION

DRIVE CONTROLLER SWITCH FAILURE

For proper drive controller electronic short circuit protection, certain values of inductance may be required in the output power wiring. Inductance can be supplied by the power wiring or auxiliary inductors.

Failure to follow these instructions can result in equipment damage.

Grounding

For safe, dependable operation, ground the drive controller according to National Electrical Code and all local codes. To ground the drive controller:

- Connect a copper wire from the equipment ground terminal to the power system ground conductor. Wire size is determined by the drive controller size and by national and local codes.
- Verify that resistance to ground is one ohm or less. Improper grounding causes intermittent and unreliable operation.

⚠ DANGER

HAZARDOUS VOLTAGE

- Ground equipment using connection provided as shown in Table 7 on page 15. Drive controller panel must be properly grounded before applying power.
- Do not use metallic conduits as a ground conductor.

Failure to follow these instructions will result in death or serious injury.

Ground multiple drive controllers as shown in Figure 6. Do not loop or series the ground cables.

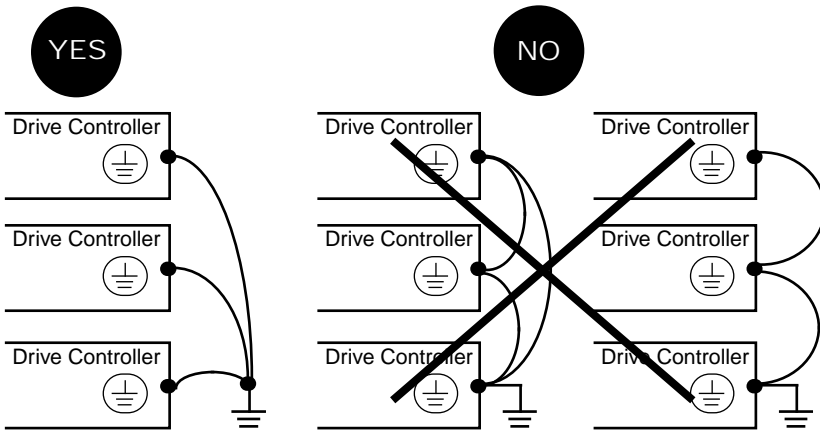





Figure 6: Grounding Multiple Drive Controllers

Power Terminals

Table 7: Power Terminal Strip Characteristics

Terminal	Function	ATV18
L1 L2	Input power	All models
L3		Three-phase units only
 E or G/E	Equipment ground connection	All models
PO	Not used. Do not disconnect link between PO and PA.	All models
PA PB	Connection for dynamic braking resistance	All models
PC	Not used	D16N4U and D23N4 only
U V W	Output connections to motor	All models
 E or G/E	Shield or equipment ground connection	All models
	Equipment ground connection	Located on heatsink on ATV18U09M2 and U18M2. Located on metal cable entry plate on other models.

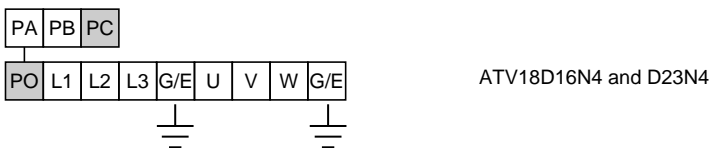
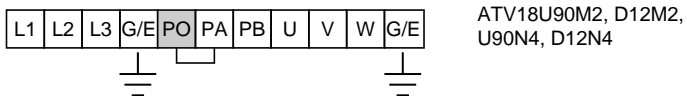
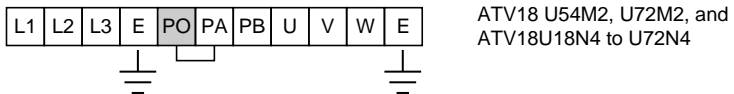
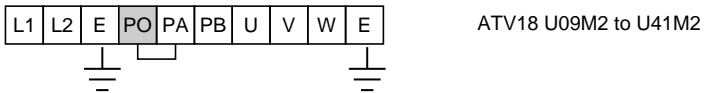

Figure 7: Location of Power Terminals

Table 8: Power Terminal Wire Size and Torque

ATV18	Maximum Wire Size ^[1] AWG (mm ²)	Torque lb-in (N•m)
U09M2, U18M2	14 (2.5)	9 (1.0)
U29M2, U41M2, U54M2, U72M2, U18N4, U29N4, U41N4, U54N4, U72N4	10 (4)	11 (1.2)
U90M2, D12M2, U90N4, D12N4	8 (10)	21 (2.4)
D16N4, D23N4	6 (10)	35 (4)

^[1] 75 °C copper.

Equipment Ground Terminal

Equipment ground terminals are located on the power terminal strip as shown in Table 7 on page 15. In addition, an M5 equipment ground screw terminal is located on the heatsink of the ATV18U09M2 and U18M2 and on the metal cable entry plate on all other units. Maximum wire size for this screw terminal is 8 AWG (10 mm²). Tightening torque is 21 lb-in (2.4 N•m) for drive controllers ATV18U09M2 and U18M2. Tightening torque is 31 lb-in (3.45 N•m) for all other units.

Control Terminals

Maximum wire size for all control terminals is 16 AWG (1.5 mm²). Tightening torque is 4.4 lb-in (0.5 N•m). The control terminals are galvanically isolated from the power section.

Table 9: Control Terminal Strip Characteristics

Terminal Reference ATV18*****	Function	Characteristics
SA SB SC	Fault relay N.O./N.C. contact Closed when drive controller energized, with no fault	Minimum: 10 mA, 24 VDC Maximum: inductive load of 0.3 A, 250 VAC 1.5 A, 30 VDC
+10	Internal supply for reference potentiometer	10 VDC, +15%, -0% 10 mA maximum Manual speed potentiometer value: 1 kΩ to 10 kΩ
AI1	Analog input 1: Speed reference voltage input	0 to +10 VDC, Impedance = 30 kΩ
AI2 or AIC ^[1]	Analog input 2: Voltage reference or Current analog input: current reference	0 to +10 VDC, Impedance = 30.55 kΩ or 0-20 mA, 4-20 mA, Impedance = 400 Ω
COM	Common for logic inputs, analog input and logic output	0 V
LI1 LI2 LI3 LI4	Logic input 1 Logic input 2 Logic input 3 Logic input 4	24 VDC; State 0: V<5 V; State 1: V>11 V; Vmax = 30 V
+24	Internal supply for logic inputs and outputs	24 VDC, 100 mA maximum
LO+	Supply for logic output, to be connected to +24 or to external 24 V supply	Maximum 30 VDC
LO	Open collector PLC-compatible logic output	+24 VDC, maximum 20 mA with internal supply or 200 mA with external supply

^[1] AI2 or AIC can be summed with AI1. Both inputs are reassignable. Do not use them at the same time.

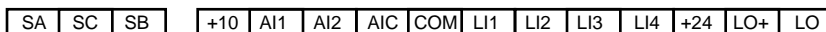
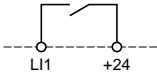

Figure 8: Location of Control Terminals

USING THE LOGIC INPUTS

The logic inputs may be operated from either the internal supply or an external supply. The possible assignments of LI1 to LI4 are shown below.

LI1: Forward. Cannot be reassigned.



When the contact is closed, the reference frequency will be applied to the motor in the forward direction.

LI2, LI3, LI4 can be assigned to the following functions:

- Reverse: $F \ 5 \ L$

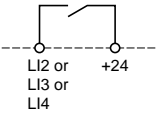

When the contact is closed, the reference frequency will be applied to the motor in the reverse direction. If LI1 and LI2 are closed at the same time, forward direction has priority. Otherwise, the direction selected first has priority.

- 2 Preset Speeds: $P \ 5 \ 2$

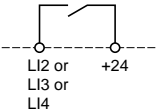

When the contact is open, the reference = LSP + analog reference. When the contact is closed, the reference = HSP.

- 4 Preset Speeds: $P \ 5 \ 4$

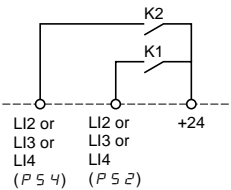

If K1 and K2 are open, reference is LSP + analog reference.
If K1 is closed and K2 is open, reference is SP3 (Speed 3).
If K1 is open and K2 is closed, reference is SP4 (Speed 4).
If K1 and K2 are closed, reference is HSP.

- Jog: $J \ 0 \ 0$

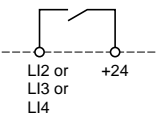

If the contact is closed, and then the direction contact is closed, the ramp time is 0.1 s regardless of the settings of ACC and dEC. If the drive is already running and the contact assigned to JOG is closed, the ramp times will be equal to ACC and dEC. The minimum time between two jog operations is 0.5 s.

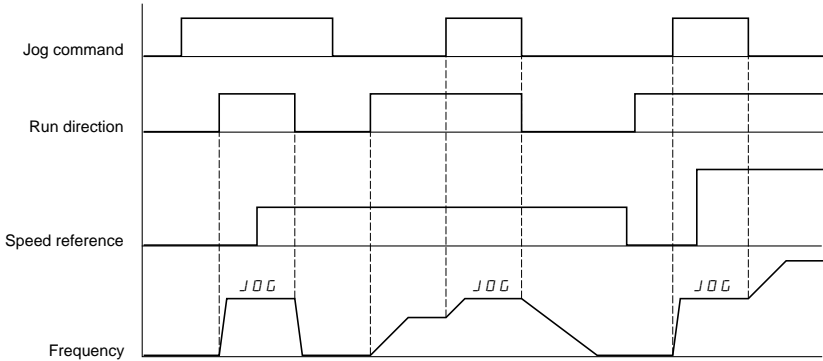
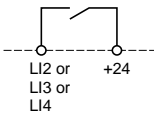

Figure 9: Jog Timing Diagram

NOTE: Whenever the drive controller is running in Jog, automatic dc injection braking upon stop is inhibited. However, DC injection braking by logic input has priority over Jog run.

- **Fast Stop: F S E**



Fast stop is commanded when the contact between the logic input assigned to this function and +24 is opened.

The ramp time is the $d E C$ time divided by 4, but limited to the minimum acceptable time for braking without causing an overbraking fault. The ramp is automatically adapted if the braking capacity is exceeded.

NOTE: When in fast stop, automatic dc injection braking and dc injection by logic input are inhibited.

- **DC Injection Braking: d C I**

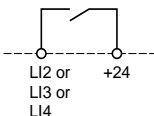

DC injection braking is commanded when the contact between the logic input assigned to this function and +24 is closed.

The current injected is equal to the drive controller nominal current for 5 seconds. After 5 seconds, the current is limited to a maximum value of 0.5 times the motor thermal current ($I E H$).

NOTE: Automatic dc injection braking remains active even if a logic input is assigned to d C I. Fast stop has priority over dc injection braking.

USING THE ANALOG INPUTS

AI1 is a 0 to +10 V analog input which is used for speed reference. In addition, one of two other analog inputs may be used, either:

- AI2: 0 to +10 V or +2 to +10 V voltage input

or

- AIC: 0 to 20 mA (factory setting) or 4 to 20 mA current input.

Analog input can be assigned to reference summing with AI1 or PI feedback.

- Reference summing with AI1: $S R I$

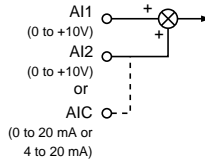

Figure 10: Reference Summing

- PI Feedback: $P I F$

This assignment automatically configures AI1 as PI setpoint input. AI2 or AIC is the PI feedback input.

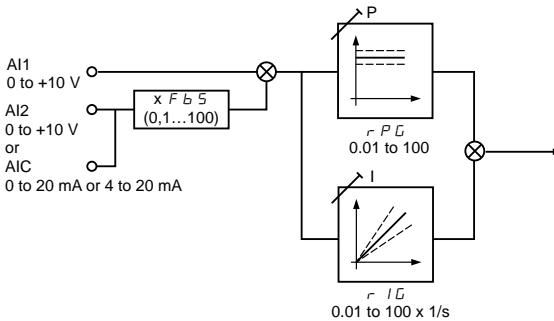

Figure 11: PI Feedback

To set up the PI regulator, with system in open loop configuration (sensor not connected), adjust High Speed setting (HSP) so that maximum flow or pressure is obtained. Then connect sensor.

The values of proportional gain ($r P G$) and integral gain ($r I G$) are factory set to give adequate performance for most applications. Factory setting for both parameters is 1.00, meaning that the output is modified by 1.00 times the input error for the proportional component and 1.00 times the input error for one second for the integral component. If improved dynamic performance is required, these parameters can be adjusted over the range of 1.00 to 100, or if the system is unstable, from 0.01 to 0.99.

Page 32 further explains the adjustment parameters $r P G$ (Proportional Gain), $r I G$ (Integral Gain) and $F b S$ (Feedback Scaling).

NOTE: The PI Feedback function is not compatible with Preset Speeds or Jog.

FUNCTION COMPATIBILITY

The number of inputs/outputs required by a function, the number of inputs/outputs on the drive controller available for reassignment, and the compatibility of the selected functions (see Figure 12) limit the number of functions which can be assigned. There are 3 assignable logic inputs on the drive controller. The following functions require one input: reverse, DC injection braking, fast stop, jog, and 2 preset speeds. The use of 4 preset speeds requires two inputs.

	Automatic DC injection braking	Summing input	PI feedback	Forward direction	Reverse direction	DC injection braking by logic input	Fast stop	Jog	Preset speeds
Automatic DC injection braking							↑	↑	
Summing input			●						
PI feedback		●						●	●
Forward direction					← ↑		↑		
Reverse direction				← ↑			↑		
DC injection braking by logic input							↑	←	←
Fast stop	←			←	←	←		←	←
Jog	←		●			↑	↑		
Preset speeds			●			↑	↑		

Function priority

●	Non-compatible functions	←	The function indicated by the arrow has priority over the other one.
□	Compatible functions	↑	
■	No significance	← ↑	The first operated has priority.

Figure 12: Function Compatibility Chart

WIRING DIAGRAM

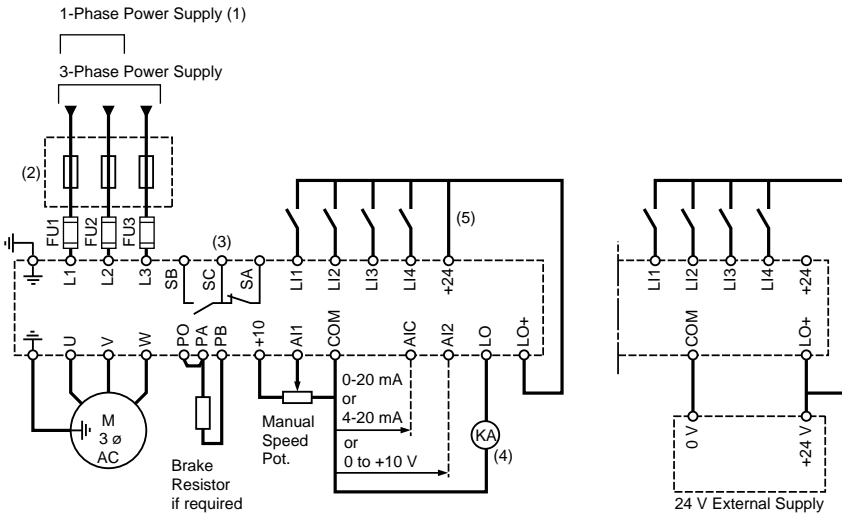

- (1) ATV18U09M2 to U41M2 only.
- (2) Line inductor if required (1-phase or 3-phase).
- (3) Fault relay contacts for remote signalling of the drive controller state. Contact state shown with drive controller deenergized or faulted.
- (4) Relay must draw ≤ 20 mA to be used on internal supply. For relay up to 200 mA, use external supply.
- (5) This jumper needed only if logic output is used. When using a +24 V external supply, connect the 0 V to the COM terminal, and connect LO+ to the external +24 V instead of the +24 V terminal on the drive controller.

Figure 13: ALTIVAR 18 Drive Controller Wiring Diagram

FAULT RELAY

The fault relay is energized whenever there is power to the drive controller and there is no fault. It is a Normally Open-Normally Closed contact.

Drive controller reset after a fault is accomplished either by cycling power, allowing the red LED (see Figure 15 on page 27) to go dark; or automatically after certain faults if automatic restart is selected. For further explanation of automatic restart, refer to page 37.

RECOMMENDED FUSES

Table 10: Recommended Fuses for 230 V Drive Controllers

Motor		Drive Controller	Fuses	
kW	HP	ATV18.....	Class CC	Class J
0.37	0.5	U09M2	600 V, 6 A	600 V, 6 A
0.75	1	U18M2	600 V, 10 A	600 V, 10 A
1.5	2	U29M2	600 V, 20 A	600 V, 20 A
2.2	3	U41M2	600 V, 25 A	600 V, 25 A
3	--	U54M2	600 V, 25 A	600 V, 25 A
4	5	U72M2	--	600 V, 30 A
5.5	7.5	U90M2	--	600 V, 40 A
7.5	10	D12M2	--	600 V, 40 A

Table 11: Recommended Fuses for 460 V Drive Controllers

Motor		Drive Controller	Fuses	
kW	HP	ATV18	Class CC	Class J
0.75	1	U18N4	600 V, 5 A	600 V, 5 A
1.5	2	U29N4	600 V, 12 A	600 V, 12 A
2.2	3	U41N4	600 V, 10 A	600 V, 10 A
3	--	U54N4	600 V, 15 A	600 V, 15 A
4	5	U72N4	600 V, 20 A	600 V, 20 A
5.5	7.5	U90N4	600 V, 25 A	600 V, 25 A
7.5	10	D12N4	--	600 V, 40 A
11	15	D16N4	--	600 V, 40 A
15	20	D23N4	--	600 V, 60 A

Equip all inductive circuits near the drive (relays, contactors, solenoid valves) with noise suppressors or connect them to a separate circuit .

When commanding the power by line contactor, avoid frequently opening and closing the line contactor which could cause premature failure of the filtering capacitors and precharge resistor. Use inputs LI1 to LI4 to command the drive. Limit operations of the line contactor to less than once per minute.

THERMAL OVERLOAD PROTECTION

- Thermal overload protection of the drive controller is accomplished by a thermal sensor on the heatsink of the drive controller and a calculation of the I^2t .
- In addition, the ALTIVAR 18 drive controller provides indirect motor thermal protection by continuously calculating the I^2t of the motor based on the setting of the ItH parameter.

These methods allow thermal protection of the motor and drive controller for normal conditions of ambient temperature.

Typical trip values are:

- motor current = 185% of nominal drive controller current for 2 seconds
- motor current = 150% of nominal drive controller current for 60 seconds

If the motor current \leq 110% of the nominal drive controller current, the drive controller will not trip.

Derating for switching frequencies $>$ 4 kHz are automatically taken into account and the allowable I^2t is reduced.

The thermal state of the drive controller is automatically reset when power is removed.

CAUTION

LOSS OF MOTOR OVERLOAD PROTECTION

- Setting the ItH parameter to maximum will disable internal motor overload protection function.
- In this case, external motor overload protection must be provided.

When using external overload relays connected to the drive controller output, the overload relay must be capable of operation over the expected range of drive controller output frequencies (including direct current).

When DC injection braking is used:

- The overload relay must be suitable for operation with direct current flowing in the motor.
- Do not use overload relays equipped with current transformers for sensing the motor current.

Failure to follow these instructions can result in equipment damage.

⚠ CAUTION

MOTOR OVERHEATING

This drive controller does not provide direct thermal protection for the motor. Use of a thermal sensor in the motor may be required for protection at all speeds and loading conditions. Consult motor manufacturer for thermal capability of motor when operated over desired speed range.

Failure to follow this instruction can result in injury or equipment damage.

AVAILABLE TORQUE

Continuous duty:

- For self-ventilated motors, motor cooling depends on the speed.
- Continuous duty results in derating for speeds less than 50% of the nameplate motor speed.

Operation in overspeed:

- In overspeed operation, the voltage no longer increases with the frequency, resulting in reduced induction in the motor which translates into loss of torque. Consult the motor manufacturer to ensure that the motor can operate in overspeed.
- For a special motor, the nominal frequency and the maximum frequency can be adjusted between 40 and 320 Hz.

⚠ CAUTION

MACHINERY OVERSPEED

Some motors and/or loads may not be suited for operation above nameplate motor speed and frequency. Consult motor manufacturer before operating motor above rated speed.

Failure to follow this instruction can result in injury or equipment damage.

Figure 14 on page 26 shows the typical torque characteristics of the ALTIVAR 18 drive controller.

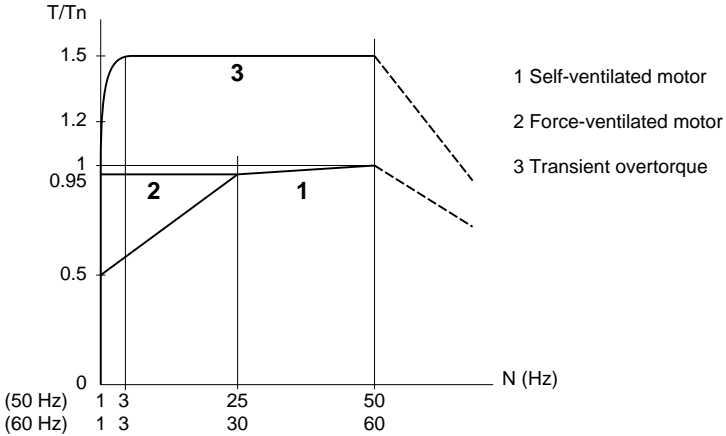

Figure 14: Typical ALTIVAR 18 Drive Controller Torque Characteristics

FACTORY SETTINGS

The ALTIVAR 18 is preset for constant torque applications. Table 12 lists factory settings.

Table 12: Factory Settings

Function	Setting
Display	Drive ready (when stopped) Reference frequency (when running)
Base frequency	50 Hz
Motor voltage	230 V or 400 V, depending on the model
Acceleration and deceleration ramps	3 s
Low speed	0 Hz
High speed	50 Hz
Frequency loop gain	Standard
Motor thermal current	Nominal drive controller current
DC braking current at stop	0.7 times nominal drive controller current for 0.5 s
Operation	Constant torque with sensorless vector control
Logic inputs	2 run directions (LI1, LI2) 4 preset speeds (LI3, LI4): 0 Hz, 5 Hz, 25 Hz, 50 Hz
Analog inputs	AI1: 0 to +10 V reference AI2 (0 to +10V) or AIC (0 to 20 mA) summed with AI1
Logic output	LO: Speed reference attained
Deceleration ramp adaptation	Automatic in the case of overvoltage when braking
Switching frequency	4 kHz

To modify these adjustments, use the keypad to change the parameter settings. The following section explains the keypad and parameters. For operation at 60 Hz, the bFr and HSP parameters must be adjusted.

USING THE DISPLAY KEYPAD

Figure 15 shows the locations and functions of the display keypad keys.

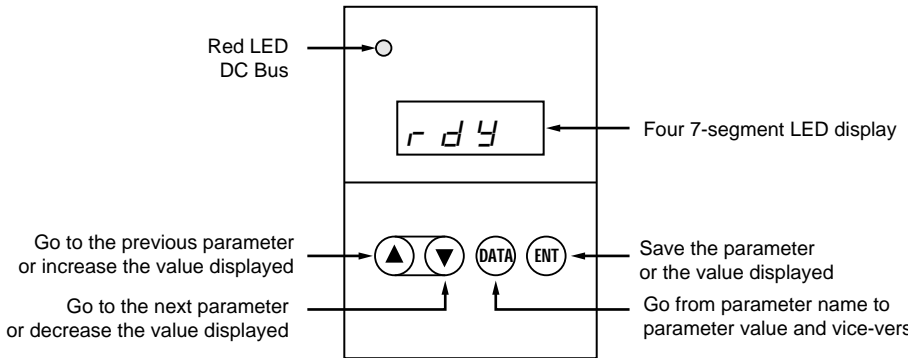

Figure 15: Functions of Keys and Display

Normal display when there is no fault:

- *l n i t* : Initialization sequence
- *r d 4* : Drive controller ready
- *4 3. 0* : Display of the reference frequency
- *d c b* : Braking by DC injection in progress
- *r t r 4* : Automatic restart in progress

Figures 16, 17, and 18 illustrate operation of the keypad push buttons.

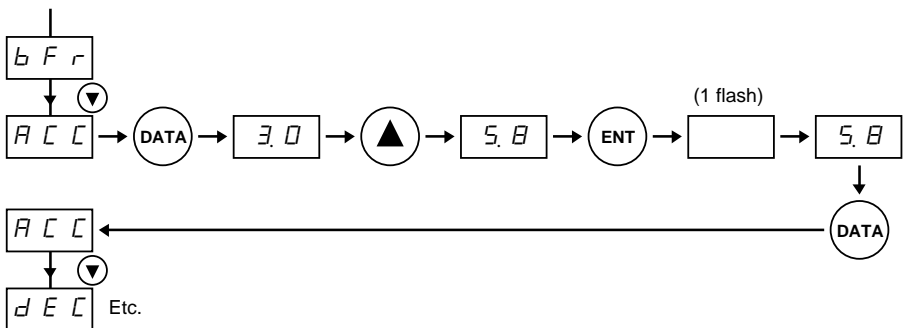

Figure 16: Example 1: Adjustment of Ramp Time

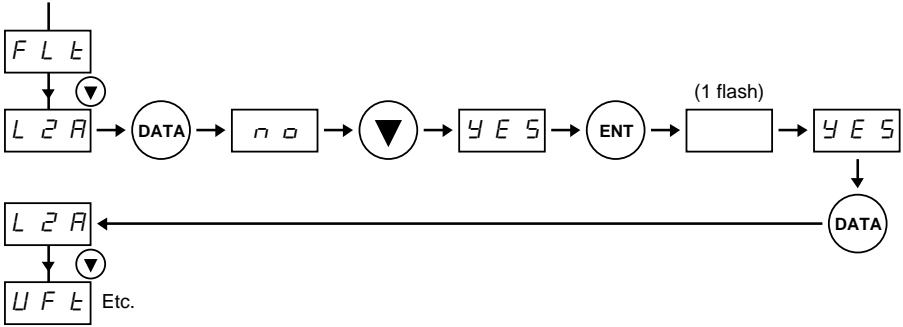

Figure 17: Example 2: Access to Level 2 Parameters

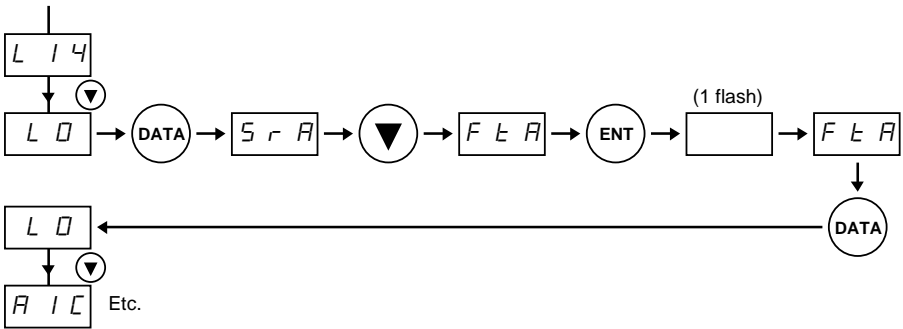

Figure 18: Example 3: Configuration of a Logic Output

PARAMETER SUMMARY

Figure 19 lists the parameters. There are two levels of access:

- Level 1: adjustments (basic configuration)
- Level 2: extensions in functionality

There are three types of parameters:

- Display: values displayed by the drive controller
- Adjustment: can be modified when the motor is running or stopped
- Configuration: only modifiable when the motor is stopped. Can be displayed when the motor is running.

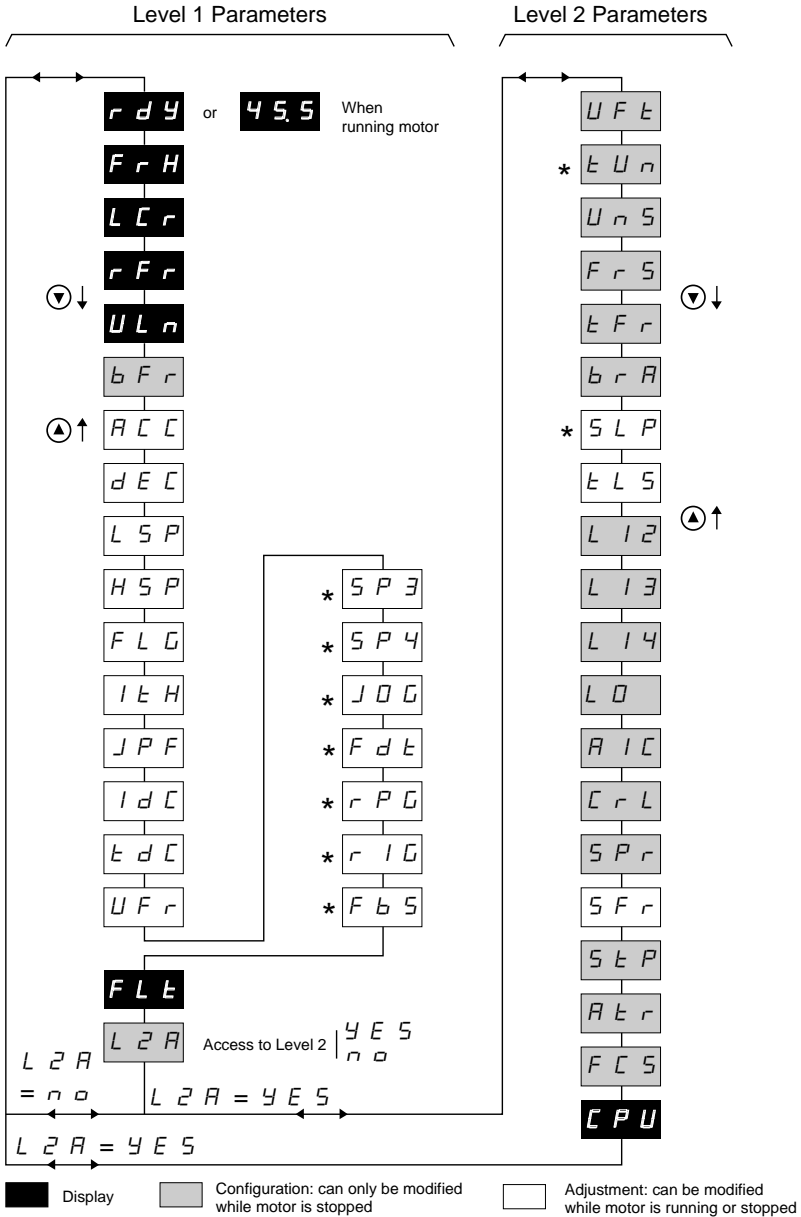

Figure 19: Parameter Summary

DRIVE CONTROLLER SET UP

Level 1 Parameters

Table 13 shows the Level 1 parameters. The maximum value is always obtained by pressing and holding the ▲ key. The minimum value is always obtained by pressing and holding the ▼ key.

Table 13: Level 1 Parameters

Code	Function	Factory Setting	Max. Value	Min. Value	Units	Min. Increment	Type	
rdY	Drive ready						Display	
FrH LCr rFr ULn	Frequency reference Motor current Rotation frequency Maintains voltage	FrH			Hz A Hz V	0.1 0.1 0.1 1	Display Display Display Display	
Choice of parameter displayed while running [1]								
bFr	Base frequency. Select the same frequency as the mains frequency		50	50	60	Hz		Config.
If the value of bFr is changed, the drive controller will display <i>err</i> as it automatically adjusts the nominal motor voltage (UnS) and nominal frequency (FrS) to the following values: ATV18...M2: bFr = 50: 230 V/50 Hz bFr = 60: 230 V/60 Hz ATV18...M4: bFr = 50: 400 V/50 Hz bFr = 60: 460 V/60 Hz The settings of UnS and FrS can be modified in the level 2 parameters.								
ACC dEC	Linear acceleration ramp Linear deceleration ramp	3.0 3.0	3600 3600	0.1 0.1	s s	0.1 (from 0.1 to 999.9) or 1 (from 1000 to 3600)	Adjust. Adjust.	
These ramps are defined for the base frequency. For example, for a 10 s ramp: if bFr = 50 Hz, 0 to 25 Hz takes 5 s if bFr = 60 Hz, 0 to 30 Hz takes 5 s								
LSP HSP	Low speed High speed: ensure that the adjustment matches the motor and the application	0.0 50.0	=HSP =tFr [2]	0.0 =LSP	Hz Hz	0.1 0.1	Adjust. Adjust.	
FLG	Frequency loop gain	33	100	0		1	Adjust.	
Dependent on the inertia and resistive torque of the driven mechanical equipment: -machines with high resistive torque or high inertia: progressively reduce FLG from 33 to 0. -machines with fast cycles, low resistive torque and low inertia: gradually increase the gain from 33 to 100. An excess of gain can cause unstable operation.								

[1] LCr, rFr and ULn cannot be saved by pressing ENT, but can be displayed momentarily, until the motor is stopped, or the next parameter is displayed.

[2] tFr is a level 2 parameter, adjustable from 40 to 320 Hz, preset at 60 Hz. For HSP > 60 Hz, first modify tFr by going to the level 2 parameters.

Table 13: Level 1 Parameters (Continued)

Code	Function	Factory Setting	Max. Value	Min. Value	Units	Min. Increment	Type
lth	Motor thermal protection ^[3]	In ^[4]	1.15 In ^[4]	0.5 In ^[4]	A	0.1	Adjust.

Adjust lth to the motor nameplate current. The thermal state of the motor thermal protection is automatically reset when power is removed. To suppress motor thermal protection, increase the value of lth to the maximum and provide external thermal protection.

⚠ CAUTION

LOSS OF MOTOR OVERLOAD PROTECTION

- Setting the lth parameter to maximum will disable internal motor overload protection function.
- In this case, external motor overload protection must be provided.

When using external overload relays connected to the drive controller output, the overload relay must be capable of operation over the expected range of drive controller output frequencies (including direct current).

When DC injection braking is used:

- The overload relay must be suitable for operation with direct current flowing in the motor.
- Do not use overload relays equipped with current transformers for sensing the motor current.

Failure to follow these instructions can result in equipment damage.

⚠ CAUTION

MOTOR OVERHEATING

This drive controller does not provide direct thermal protection for the motor. Use of a thermal sensor in the motor may be required for protection at all speeds and loading conditions. Consult motor manufacturer for thermal capability of motor when operated over desired speed range.

Failure to follow this instruction can result in injury or equipment damage.

JPF	Jump frequency with a bandwidth of 2 Hz. Suppression of a critical speed which causes mechanical resonance. Factory setting of 0 indicates that the function is not used.	0.0	HSP	0.0	Hz	0.1	Adjust.
-----	---	-----	-----	-----	----	-----	---------

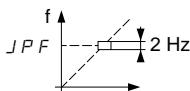

^[3] For motors in parallel fed by the same drive controller, a separate thermal relay should be added for each motor.

^[4] In = drive controller rated output current. See Table 1 and Table 2 on page 2 and Table 3 on page 3.

Table 13: Level 1 Parameters (Continued)

Code	Function	Factory Setting	Max. Value	Min. Value	Units	Min. Increment	Type
ldc	Automatic DC injection current level	0.7 In ^[4]	In ^[4]	0.25 ItH	A	0.1	Adjust.
tdc	Automatic DC injection current time	0.5	25.5	0.0	s	0.1	Adjust.
Adjustment to 0 suppresses automatic DC injection. Adjustment to 25.5 causes permanent injection of DC upon stop. ^[5]							
⚠ WARNING							
NO HOLDING TORQUE							
<ul style="list-style-type: none"> • DC injection braking does not provide holding torque at zero speed. • DC injection braking does not function during loss of power or drive controller fault. • When required, use separate brake for holding torque. 							
Failure to follow these instructions can result in death, serious injury, or equipment damage.							
UFr	Allows optimization of torque at low speed	20	100	0		1	Adjust.
SP3 ^[6]	3rd preset speed	5.0	HSP	LSP	Hz	0.1	Adjust.
SP4 ^[6]	4th preset speed	25.0	HSP	LSP	Hz	0.1	Adjust.
JOG ^[6]	Jog speed	10	10	0	Hz	0.1	Adjust.
Fdt ^[6]	Frequency level associated with "frequency level attained" when LO is assigned to this function. This level allows a hysteresis of 0.2 Hz.	0	HSP	LSP	Hz	0.1	Adjust.
rPG ^[6]	Proportional gain for the PI feedback function	1	100.0	0.01		0.01	Adjust
rIG ^[6]	Integral gain for the PI feedback function	1	100.0	0.01	1/s	0.01	Adjust.
FbS ^[6]	Feedback scaling factor for the PI feedback function, associated with the analog input AIC or AI2.	1	100.0	0.1		0.1	Adjust.
FLt	By pressing the DATA key when this parameter is displayed, the last fault can be displayed. When there has been no fault, the display is nErr.						Display
L2A	Level 2 access	no	YES	no			Config.
no: no → next display will be rdY if down arrow pressed yes: YES → next display will be the first level 2 parameter if down arrow pressed							

^[4] In = drive controller rated output current. See Table 1 and Table 2 on page 2 and Table 3 on page 3:

^[5] Note that during braking, configuration parameters cannot be modified. Adjust tdc to 25.5 s if continuous DC injection is necessary.

^[6] These parameters only appear if the associated functions have been selected.

Level 2 Parameters

Level 2 parameters are accessed by setting the L2A parameter to yes. Table 14 lists the Level 2 parameters and their functions. The maximum value is always obtained by pressing and holding the ▲ key. The minimum value is always obtained by pressing and holding the ▼ key.

WARNING

UNINTENDED EQUIPMENT ACTION

- Application of voltages to the logic inputs while a Level 2 parameter is being adjusted may result in power being applied to the motor.
- While changing a Level 2 parameter, ensure that no voltage is applied to the logic inputs.



Failure to follow these instructions can result in death, serious injury, or equipment damage.

Table 14: Level 2 Parameters

Code	Function	Factory Setting	Max Value	Min Value	Units	Min Increment	Type
UFt	Selection of the type of volts/ frequency ratio L: constant torque for special motors or motors connected in parallel P: variable torque n: sensorless flux vector control for constant torque applications nLd: energy savings, for variable torque applications	n	L	nLd			Config.
tUn	Auto-tune. Only active when UFt is set for n or nLd. no: no auto-tune (factory parameters for standard IEC motors) donE: auto-tune has already been performed (auto-tune parameters already in use) YES: setting to YES and pressing ENT starts auto-tune When auto-tune is completed, rdY is displayed. Returning to tUn displays donE. If tnF (tuning fault) appears, the motor is not adapted to the drive controller. Use L or P mode.	no	YES	no			Config.
UnS	Nominal motor voltage. Set to the nameplate value. Maximum, minimum and factory preset values depend on the model and the setting of the bFr parameter (level 1). ATV18...M2 ATV18...N4 with bFr = 50 ATV18...N4 with bFr = 60						Config.
		230 400 460	240 460 460	200 380 380	V V V	1 1 1	
FRs	Nominal motor frequency Set to the nameplate value if it is different from that set by bFr.	bFr	320.0	40.0	Hz	0.1	Config.
tFr	Maximum output frequency	60.0	320.0	40.0	Hz	0.1	Config.
⚠ CAUTION							
MACHINERY OVERSPEED							
Some motors and/or loads may not be suited for operation above nameplate motor speed and frequency. Consult motor manufacturer before operating motor above rated speed.							
Failure to follow this instruction can result in injury or equipment damage.							
brA	Automatic deceleration ramp adaptation to avoid an overbraking (ObF) fault. YES: function active no: function not active This function may be incompatible with the use of dynamic braking.	YES	no	YES			Config.
SLP	Slip compensation This parameter only appears if UFt is set for n.	^[1]	5.0	0.0	Hz	0.1	Adjust.
tLS	Low speed run time. Time at which the motor runs at LSP if reference goes to 0 and direction command (FW or RV) is still present. If tLS = 0, the drive controller will run at the LSP setting as long as FW or RV is present. The drive controller restarts when the reference becomes greater than 0, or if the direction input (FW or RV) is cycled.	0.0	25.5	0.0	s	0.1	Adjust.

^[1] The factory setting depends on the drive controller rating.

Table 14: Level 2 Parameters (Continued)

Code	Function	Factory Setting	Max Value	Min Value	Units	Min Increment	Type
LI2	Reassignment of the LI2 logic input Note: Before assigning, make sure that there is no voltage to the logic input.						
	 WARNING						
	<p>UNINTENDED EQUIPMENT ACTION</p> <ul style="list-style-type: none"> Assigning a logic input when it is in state 1 (high, with voltage present) can cause the motor to start. Before assigning, verify that there is no voltage to the logic input. <p>Failure to follow these instructions can result in death, serious injury, or equipment damage.</p>						
	If the function is already assigned to another input, it will appear as a choice, but will not be saved upon pressing ENT. If PS2 and PS4 are both assigned, the input assigned to PS4 must be changed before the input assigned to PS2 can be changed.						
	If AIC is assigned for summing with AI1 (SAI) [2], and one of the logic inputs is assigned to PS2 [2], the choices for LI2 are: OFF: not assigned rrS: reverse dCl: continuous dc injection braking drive In for 5s, then at 0.5 lth	rrS	OFF	PS4			Config.
	 WARNING						
	<p>NO HOLDING TORQUE</p> <ul style="list-style-type: none"> DC injection braking does not provide holding torque at zero speed. DC injection braking does not function during loss of power or drive controller fault. When required, use separate brake for holding torque. <p>Failure to follow these instructions can result in death, serious injury, or equipment damage.</p>						
	<p>FS: Fast stop. This function is active when the LI is at state 0 (off) JOG: Jog [3] PS2: 2 preset speeds [3] (however, display will not flash when ENT is pressed because another input was already assigned to PS2) PS4: 4 preset speeds [3]</p>						
	If AIC is assigned for summing with AI1 (SAI), and no other LI is assigned to PS2, the choices for LI2 are: OFF: not assigned rrS: reverse dCl: continuous dc injection braking at drive In for 5s, then at 0.5 lth						
	FS: Fast stop. This function is active when the LI is at state 0 (off) JOG: Jog [3] PS2: 2 preset speeds [3]	rrS	OFF	PS2			Config.
	When AIC is assigned to PI feedback, the choices for LI2 are: OFF: not assigned rrS: reverse dCl: continuous dc injection braking at drive controller In for 5s, then at 0.5 lth FSt: Fast stop. This function is active when the LI is at state 0 (off).	rrS	OFF	FSt			Config.

[2] Factory setting.

[3] These function cause parameters to appear in Level 1 (JOG, SP2, SP4) which must be adjusted.

Table 14: Level 2 Parameters (Continued)

Code	Function	Factory Setting	Max Value	Min Value	Units	Min Increment	Type
LI3	Reassignment of the LI3 logic input. Same as LI2. To reassign LI3 from PS2 if LI4 is set to PS4, LI4 must be reassigned first.	PS2	•	•			
LI4	Reassignment of the LI4 logic input. Same as LI2.	PS4	•	•			
LO	Assignment of logic output. There are 2 choices: SrA: Speed reference attained, with a hysteresis of ± 2.5 Hz	SrA	SrA	FtA			Config.
AIC	Assignment of the analog input AIC/AI2.						
	If the logic inputs are not assigned to PS2, PS4 or JOG, the choices are: SAI: Reference summing with AI1 PIF: PI feedback. This configuration automatically assigns AI1 as PI setpoint input and causes rPG, rIG, and FbS to appear in the Level 1 parameters. Note: PIF is only possible if the logic inputs have previously been assigned as follows in this order: 1) LI4 = OFF or FSt 2) LI3 = OFF or dCI 3) LI2 = OFF or rrS	SAI	SAI	PIF			Config.
	If a logic input is assigned to PS2, PS4 or JOG, the choice is: SAI: Reference summing with AI1	SAI	SAI	SAI			Config.
CrL	Configuration of the AIC/AI2 input current range: 0.0 = AIC:0 to 20 mA, AI2: 0 to +10 V 4.0 = AIC:4 to 20 mA, AI2: 2 to +10 V	0.0	0.0	4.0	mA		Config.
SPr	Automatic catch on the fly with speed research. After a brief input line undervoltage, the motor restarts following a ramp without starting at zero. The maximum time for speed research is 3.2 s. The speed reference and the run direction input must be maintained when power is restored. no: Function not active YES: Function active	no	no	YES			Config.

 **WARNING**

UNINTENDED EQUIPMENT ACTION

- Automatic catch on the fly can only be used for machines or installations that present no danger in the event of automatic restarting, either for personnel or equipment.
- Equipment operation must conform with national and local safety regulations.

Failure to follow these instructions can result in death, serious injury, or equipment damage.

Table 14: Level 2 Parameters (Continued)

Code	Function	Factory Setting	Max Value	Min Value	Units	Min Increment	Type
SFr	Switching frequency, adjustable in order to reduce audible motor noise generated by the motor. Above 4 kHz, the drive controller output current must be derated as follows: ATV18U09M2U, U18M2U, U29M2U, U41M2U, U54M2U: no derating necessary All other models: ≤ 8 kHz: 5% derating > 8 kHz: 10% derating	4.0	12.0	2.2	kHz	0.1	Adjust.
StP	Controlled stop upon loss of input power. no: motor coasts to stop at loss of input power YES: deceleration follows a self-adjusting ramp which is a function of the regenerated energy	no	YES	no			Config.
Atr	Automatic restart after a fault if the cause of the fault has disappeared and the other operating conditions allow it. The drive controller will attempt to restart after 1s, then 5s, then 10s, and then 1 minute for the remaining attempts. If the fault is still present after 5 minutes, the fault relay de-energizes and the drive controller must be reset by cycling power. Automatic restart can be attempted after the following faults: OHF, OLF, USF, ObF, OSF. The drive controller fault relay remains energized if the function is active. The speed reference and the rotation direction must be maintained. no: Function not active YES: function active	no	YES	no			Config.
 WARNING							
<p>UNINTENDED EQUIPMENT ACTION</p> <ul style="list-style-type: none"> Automatic restart can only be used for machines or installations that present no danger in the event of automatic restarting, either for personnel or equipment. Equipment operation must conform with national and local safety regulations. <p>Failure to follow these instructions can result in death, serious injury, or equipment damage.</p>							
FCS	Return to factory settings no: do not return to factory settings YES: Return to factory settings, display will then be rdY	no	no	YES			Config.
CPU	Firmware version	•	•	•			Display

MAINTENANCE

Read the following safety statements before proceeding with any maintenance or troubleshooting procedures.

The following steps should be done at regular intervals:

- Check the condition and tightness of the connections.
- Make sure ventilation is effective and temperature around the drive controller remains at an acceptable level. The average lifetime of the fans is 3 to 5 years depending on the conditions of use.
- Remove dust and debris from the drive controller, if necessary.

PRECAUTIONS

Table 15 on page 42 lists the fault codes for the faults which can be automatically reset, the probable causes of the faults and associated corrective action. Table 16 on page 43 lists the fault codes for the faults which are not automatically resettable (thus requiring reset by cycling power) along with the probable causes of the faults and associated corrective action. When taking corrective action, follow the procedures outlined on pages 39-41.

 DANGER	
HAZARDOUS VOLTAGE	
Read and understand these procedures before servicing ALTIVAR 18 drive controllers. Installation, adjustment, and maintenance of these drive controllers must be performed by qualified personnel.	
Failure to follow these instructions will cause shock or burn, resulting in death or serious injury.	

The following procedures are intended for use by qualified electrical maintenance personnel and should not be viewed as sufficient instruction for those who are not otherwise qualified to operate, service, or maintain the equipment discussed.

Procedure 1: Bus Voltage Measurement

DANGER

HAZARDOUS VOLTAGE

- Read and understand Bus Voltage Measurement Procedure before performing procedure. Measurement of bus capacitor voltage must be performed by qualified personnel.
- DO NOT short across capacitors or touch unshielded components or terminal strip screw connections with voltage present.
- Many parts in this drive controller, including printed wiring boards, operate at line voltage. DO NOT TOUCH. Use only electrically insulated tools.

Failure to follow these precautions will cause shock or burn, resulting in death or serious injury.

Drive Controllers ATV18•••M2 and ATV18U18N4 to D12N4

The voltage is measured between the equipment ground and each terminal on the power terminal strip. The equipment ground is located on the heatsink for drive controllers ATV18U09M2 and U18M2, and on the metal conduit entry plate for the other products. The power terminal strip is located on the power board, as shown in Figure 20 on page 40. A second measurement is made between the PA terminal, located on the power terminal strip and the other terminals on the power terminal strip. To measure the bus capacitor voltage:

1. Disconnect all power from drive controller.
2. Wait 1 minute to allow the DC bus to discharge.
3. Remove all covers.
4. Set the voltmeter to the 1000 VDC scale. Measure the voltage between the equipment ground terminal and each terminal on the power terminal strip and verify the DC voltage is less than 45 V for each measurement.
5. With the voltmeter at the 1000 VDC scale, measure between the PA terminal and all of the other terminals on the power terminal strip. Verify the DC voltage is less than 45 V for each measurement.
6. If the bus capacitors are not fully discharged, contact your local Square D representative – **do not operate the drive controller.**
7. Replace all covers.

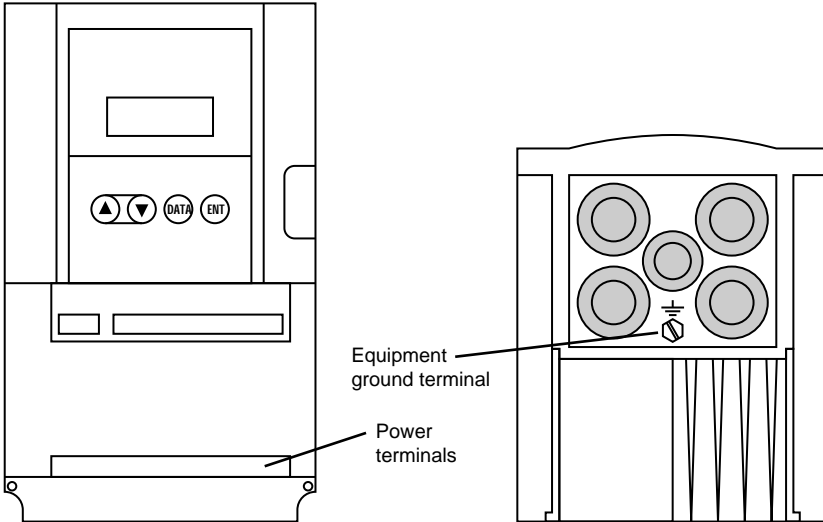

Figure 20: Measuring Bus Capacitor Voltage

Drive Controllers ATV18D16N4 and ATV18D23N4

For these drive controllers, the voltage is measured between the PA and PC terminals located on the power board, as shown in Figure 20. To measure the bus capacitor voltage:

1. Disconnect all power from drive controller.
2. Wait 1 minute to allow the DC bus to discharge.
3. Remove all covers.
4. Set the voltmeter to the 1000 VDC scale. Measure the bus capacitor voltage between the PA and PC terminals to verify that DC voltage is less than 45 V. **Do not short across capacitor terminals with voltage present!**
5. If the bus capacitors are not fully discharged, contact your local Square D representative – **do not operate the drive controller**.
6. Replace all covers.

Procedure 2: Checking Supply Voltage

To measure the input line voltage:

1. Perform Bus Voltage Measurement procedure (see page 39).
2. Attach meter leads to L1 & L2. Set voltmeter to the 600 VAC scale.
3. Reapply power and check for correct line voltage, per drive controller nameplate rating.
4. Remove power and repeat procedure for L2 & L3, and L1 & L3 if wired for three phase.
5. When all phases have been measured, remove power. Remove leads and reinstall covers.

Procedure 3: Checking the Peripheral Equipment

The following equipment may need to be checked. Follow the manufacturers' procedures when checking this equipment.

1. A protective device such as fuses or circuit breaker may have tripped.
2. A switching device such as a contactor may not be closing at the correct time.
3. Conductors may require repair or replacement.
4. Connection cables to the motor or high resistance connections to ground may need to be checked. Follow NEMA standard procedure WC-53.
5. Motor insulation may need to be checked. Follow NEMA standard procedure MG-1. Do not apply high voltage to U, V, or W. Do not connect the high potential dielectric test equipment or insulation resistance tester to the drive controller since the test voltages used may damage the drive controller. Always disconnect the drive controller from the conductors or motor while performing such tests.

CAUTION

EQUIPMENT DAMAGE HAZARD

- Do not perform high potential dielectric tests on circuits while the circuits are connected to the drive controller.
- Any circuit requiring high potential dielectric tests must be disconnected from the drive controller prior to performing the test.

Failure to follow these precautions can result in equipment damage.

Fault Storage

The first fault detected is saved and displayed on the keypad screen if power is maintained. The drive trips and the fault relay opens.

To reset the fault:

- Remove power from the drive controller.
- Before switching power back on, identify and correct the cause of the fault.
- Restore power. This will reset the fault if it has been corrected.

In certain cases, if automatic restart has been enabled, the drive can be automatically restarted after the cause of the fault has disappeared. Refer to the Level 2 parameters.

FAULT CODES

Table 15: Resettable Faults with Automatic Restart

Fault	Probable Causes	Corrective Actions
OHF Drive Overload	<ul style="list-style-type: none"> • Drive controller I^2t too high or • Drive controller temperature too high 	<ul style="list-style-type: none"> • Ensure the motor load is not greater than intended for the drive controller. Check settings of motor voltage (UnS) and motor frequency (FrS). Verify drive controller ventilation is sufficient and the environment is controlled. • Wait for the drive controller to cool down before restarting.
OLF Motor Overload	<ul style="list-style-type: none"> • Thermal trip due to prolonged motor overload • Motor I^2t too high 	<ul style="list-style-type: none"> • Check the motor thermal protection adjustment (Ith). • Ensure the motor load is not greater than intended for the drive controller. • Wait for the motor to cool down before restarting.
OSF Overvoltage in steady state or acceleration	<ul style="list-style-type: none"> • Input voltage too high or • Noisy mains 	<ul style="list-style-type: none"> • Verify the input voltage (Procedure 2 on page 41). • Consider the installation of line inductors.
USF Undervoltage	<ul style="list-style-type: none"> • Input voltage too low or • Failed precharge resistance 	<ul style="list-style-type: none"> • Verify the input voltage (Procedure 2 on page 41) and the voltage parameter (UnS). • Reset. • Replace the drive controller.
ObF Overvoltage in deceleration	Overbraking due to excessive braking or overhauling load	<ul style="list-style-type: none"> • Increase the deceleration time. • Activate the brA function if compatible with application. • Add dynamic braking resistor if necessary.

Table 16: Non-Automatically Resettable Faults

Fault	Probable Causes	Corrective Actions
OCF Overcurrent	<ul style="list-style-type: none"> • Output of the drive short-circuited or grounded, or • Overcurrent in the braking resistance 	<ul style="list-style-type: none"> • Switch drive off. Disconnect drive controller from motor at U,V,W. • Check cables connected to motor and motor insulation (Procedure 3 on page 41). • Check the dynamic braking resistance. With the drive disconnected, verify the wiring, the isolation of the resistance, and its ohmic value (Procedure 3 on page 41).
dbF Dynamic braking overload	Overload of dynamic braking circuit	<ul style="list-style-type: none"> • Verify the ohmic value of the resistance. • Ensure that the drive controller horsepower size meets the application.
InF Internal fault	Internal fault	<ul style="list-style-type: none"> • Verify that electromagnetic interference does not effect drive controller operation. • Replace the drive controller.
tnF Auto-tuning fault	<ul style="list-style-type: none"> • Special motor • Motor horsepower size different from drive controller 	Use L or P law.
EEF	Memory failure	Replace the drive controller.

A

ACC 18, 30
AIC 17, 20, 35–36
analog input 20, 26, 36
automatic reset 24
automatic restart 22, 27, 37, 42
auto-tuning fault 43

B

base frequency 26, 30
bFr 26, 30
brA 34
braking
 dc injection 19, 21, 26–27, 31, 35
 dynamic 15, 34, 42–43
braking torque 4
branch circuit connections 12

C

cable output 13
cable shields 9–10, 15
can 38
capacitance
 maximum 13
clearances
 minimum 6
COM 17
condensation 8
constant torque 33
control
 terminals 17
control command wiring 10
CPU 37

current
 dc injection 32
 full load 12
 input 12
 motor 24, 30
 motor thermal 26
 nominal 26
 overcurrent 12, 43

D

dbF 43
dc injection 21, 27, 31–32, 35
dcl 35
dEC 18, 30
dimensions 5
drive
 ready 30
drive overload 42
dynamic braking 15, 34, 42–43

E

EEF 43
enclosures
 NEMA Type 12 (IP54) 8
 sizing 6–8
 ventilation 8

F

fan flow rates 5
fast stop 19, 21, 35
fault
 auto-tuning 43
 codes 38, 42
 internal 43
 overbreaking 34

 storage 42
 fault relay 17, 22
 fault relay wiring 10
 fault reset 22, 37–38, 42
 faults
 overcurrent 12
FbS 32
FCS 37
Fdt 32
FL 32
FLG 30
frequency
 base 26, 30
 input 4
 jump 31
 maximum 25, 33
 nominal 25, 30
 output 4
 reference 27, 30
 rotation 30
 switching 4, 26

FrH 30
FrS 33
FSt 35
FtA 36
full load current 12
fuses 23

G

grounding 14–16, 39

H

heatsink 15–16, 24, 39
holding torque 32, 35
HSP 18, 26, 30–32

I

Idc 32
In 32
InF 43
input
 analog 20, 26, 36
 current 12
 frequency 4
 logic 17–18, 26, 33, 35–36
 phases 4
 power 15
 single-phase 2
 three-phase 2–3, 15
 voltage 4, 17, 41–42
input wiring 10
inspection 1
internal fault 43
Ith 31–32, 35

J

jog 18, 21, 32, 35
JPF 31
jump frequency 31

L

L2A 32
LCr 30
LI1 17–18
LI2 17–18, 35–36
LI3 17–18, 36
LI4 17–18, 36
logic input 17–18, 26, 33,
35–36
logic output 17, 26, 28, 36
LSP 18, 30, 32, 34

M

maximum capacitance 13
maximum frequency 25, 33
memory failure 43
motor current 24, 30
motor overload 42
motor thermal current 26
motor voltage 30, 33
motor wiring 10
mounting 10
 NEMA Type 12 (IP54) 8
multiple drives 14

N

nominal current 26
nominal frequency 25, 30

O

ObF 42
OCF 43
OFF 35
OHF 42
OLF 42
OSF 42
output
 cable 13
 logic 17, 26, 28, 36
 three-phase 2–3
 wiring 13
output frequency 4
output phases 4
output voltage 4
overcurrent 6, 12, 43
overheating
 motor 25, 31

overload
 drive 42
 motor 42
overspeed 25
overvoltage 42

P

parameter summary 29
phases
 input 4
 output 4
PI feedback 20–21, 32
PI regulator 20
PIF 36
power
 input 15
 terminals 15–16, 39
power wiring 12
preset speeds 18, 21, 35
protection 1, 4, 6, 12, 38
 thermal 24, 31, 42
PS2 35–36
PS4 35–36

R

rdY 30, 37
reference frequency 27
reset 31
 automatic 24
 fault 22, 37–38, 42
restart 34, 36
 automatic 22, 27, 37, 42
rFr 30
rIG 32
rotation frequency 30
rPG 32

S

SA 17

SAI 36

SB 17

SC 17

SFr 37

shipping 1

slip compensation 34

SLP 34

SP3 32

SP4 32

SrA 36

storing 1

StP 37

switching frequency 26

T

tdc 32

temperature 4, 6–7, 24

terminal blocks 11

terminal wiring 11

terminals

control 17

power 15–16, 39

tFr 33

thermal protection 24, 31, 42

thermal resistance 7–8

tightening torque 16–17

tLS 34

tnF 43

torque

available 25

braking 4

constant 26, 33

holding 32, 35

tightening 16–17

typical 25

variable 33

tUn 33

U

UFr 32

UFt 33

ULn 30

undervoltage 36, 42

UnS 33

USF 42

V

variable torque 33

ventilation 8, 38

ventilation flow 6, 8

voltage

bus capacitor 39–41

input 4, 17, 41–42

motor 26, 30, 33

output 4

W

wiring

control/command 10

diagram 22

fault relay 10

general practices 12

input 10

motor 10

output 13

power 12

terminal 11



GROUPE SCHNEIDER

■ Merlin Gerin ■ Square D ■ Telemecanique

52012-008-01 March 1997 Printed in USA

© 1997 Schneider S.A. All Rights Reserved