

TFT-LCD TV





W152T

USER MANUAL

READ CAREFULLY
BEFORE OPERATION



IMPORTANT SAFETY INSTRUCTIONS

	CAUTION RISK OF ELECTRIC SHOCK. DO NOT OPEN.		TO PREVENT ELECTRICAL SHOCK. DO NOT REMOVE THIS COVER. NO USER-SERVICEABLE PARTS INSIDE. REFER SERVICING TO QUALIFIED SERVICE PERSONNEL.
	This symbol indicates " dangerous voltage " inside the product that presents a risk of electric shock or personal injury.		This symbol indicates important instructions accompanying the product.

Please read this manual carefully before using this product.

- Before connecting the AC power cord to the DC adapter outlet ,make sure the voltage designation ofthe LCD TV corresponds to the local electrical supply . If you are unsure of your power supply , ask your local power company .
- Never insert anything metallic into the cabinet openings of the liquid crystal display (LCD)TV/monitor;otherwise it may create the danger of electric shock.
- To avoid electric shock, Never touch the inside of the LCD TV/monitor and adapter. Only a qualified technician should open the case of the LCD TV/ monitor/adapter.
- Never use your LCD TV/monitor/adapter if the power cord has been damaged. Do not allow anything to rest on the power cord, and keep the cord away from place where people can trip over it .
- Be sure to hold the plug, not the cord, when disconnecting the adapter from an electric socket.
- Openings in the LCD TV/monitor/adapter cabinet are provided for ventilation. To prevent overheating, these openings should not be blocked or covered. Also, avoid using the LCD TV/monitor on a bed ,sofa ,rug, or other soft surface. Doing so may block the ventilation openings in the bottom of the cabinet. If you put the LCD TV/monitor in a bookcase or some other enclosed space, be sure to provide adequate ventilation.

IMPORTANT SAFETY INSTRUCTIONS

- Do not expose the LCD TV/monitor to extreme temperature conditions or to extreme humidity conditions.
- The apparatus shall not be exposed to dripping or splashing and that no objects filled with liquids, such as vases, shall be placed on the apparatus.
- Do not place the LCD TV/monitor on an unstable cart, stand, tripod, bracket, table, or floor where it can fall. It is damaged if dropped, hit or scratched. Do not clean the front with keton-type materials (e.g. Acetone), ethyl alcohol, toluene, ethyl acid, methyl, or chloride—these may damage the panel.
- Locate your DC adapter near an easily accessible AC outlet.
- If your LCD TV/monitor does not operate normally in particular, if there are any unusual sounds or smells coming from it, unplug it immediately and contact an authorized dealer or service center.
- High temperature can cause problems. Don't use your LCD TV/monitor in direct sunlight, and keep it away from heaters, stoves, fireplaces, and other sources of heat.
- Unplug the DC adapter when it is going to be left unused for an extended period of time.
- To reduce the risk of fire or electric shock, and annoying interference, use the recommended accessories only.
- If the LCD TV/monitor is broken, do not try to repair it yourself. Contact qualified service personnel.
- Unplug your DC adapter from the AC outlet before any service.
- Be sure the service technician uses authorized replacement parts or their equivalents. Unauthorized parts may cause fire, electrical shock, or other hazards.
- Following any service or repair, be sure the service technician performs safety checks to certify that your TFT-LCD TV/monitor is in safe operating order.
- The apparatus with CLASS I construction shall be connected to a MAINS socket outlet with a protective earthing connection.

CONTENT

INSTALLATION	
Normal installation	1
PANEL BUTTON FUNCTIONS	
Front panel	2
Right panel	3
Left panel	2
Rear panel	3
EXTERNAL EQUIPMENT	
Connecting figure	4
REMOTE CONTROLLER	
Remote buttons	5
Battery installation	7
LET'S START	
Change source operation	8
TV MENU SETUP	
Picture	9
TV setting	11
Nicam/bilingual receiving	14
Sound	10
System setting	13
TELETEXT FUNCTION	
Teletext display	15
Mix mode	15
Index	15
Display mode	16
Page selection	15
Lock	15
Zoom in teletext	16
Colorized buttons	16
AV, S-VIDEO , SCART AND YPbPr SETUP	
Video setting menu	17
VGA SETUP	
Picture	18
Monitor setting	20
Sound	19
Function	21
TIME SETTINGS	
Time setting	22
DVB OPERATION	
General setting	24
Auto search	26
Channel setting	28
Adanced setting	25
Manual search	27
EPG	29
TROUBLE SHOOTING	
Display troubleshooting	30
Sound and TV troubleshooting	30
SPECIFICATIONS	
Specifications	31
DISPLAY MODE	
Display mode	32

INSTALLATION

NORMAL INSTALLATION

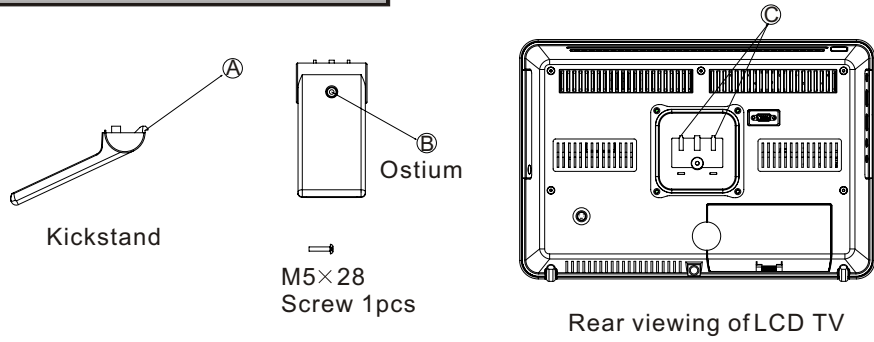

- 1, Hook the tache (labeled A) of the kickstand on to the slot (labeled C)
- 2, Tighten the screws (M5×28) through the ostium (labeled B).
- 3, Figure ❶ shows the finished installation.

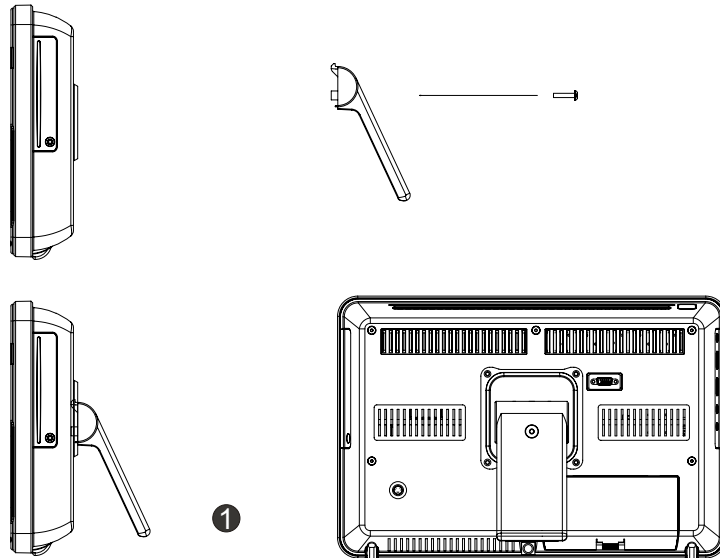

PANEL BUTTON FUNCTIONS

FRONT PANEL

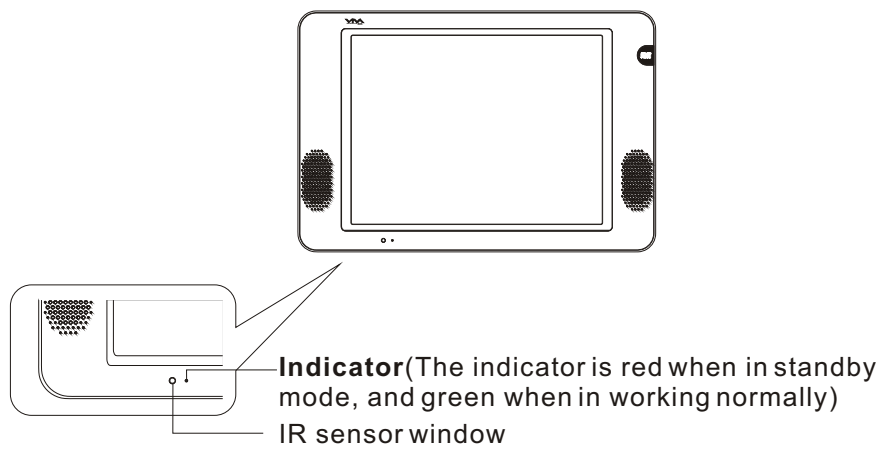

LEFT PANEL

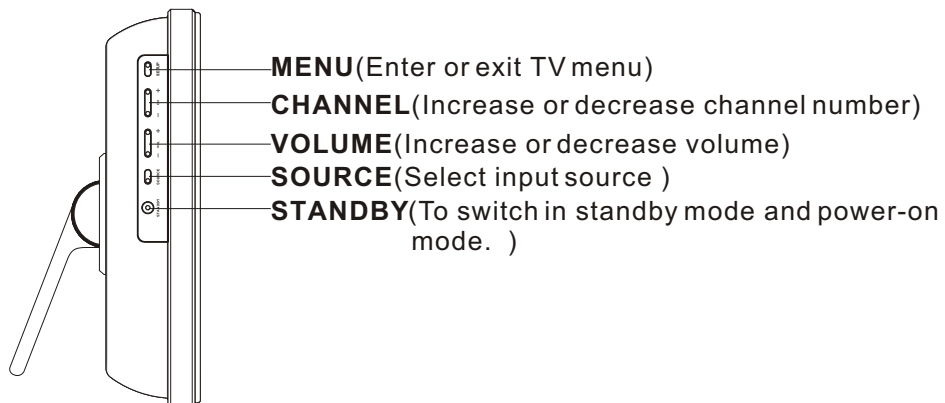

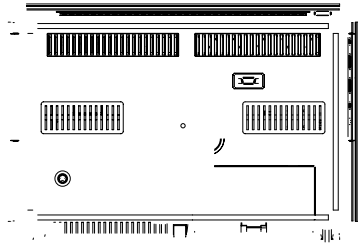

EXTERNAL EQUIPMENT

CONNECTING DIAGRAM

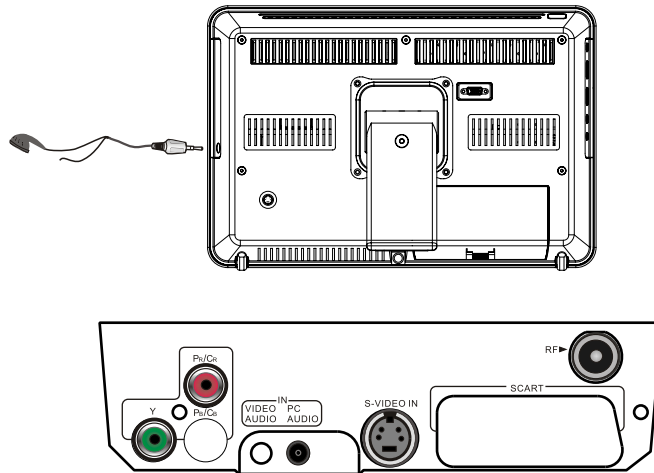

NOTE

You should insert all interconnecting cables BEFORE plugging in the power cord.

REMOTE CONTROLLER

REMOTE BUTTONS

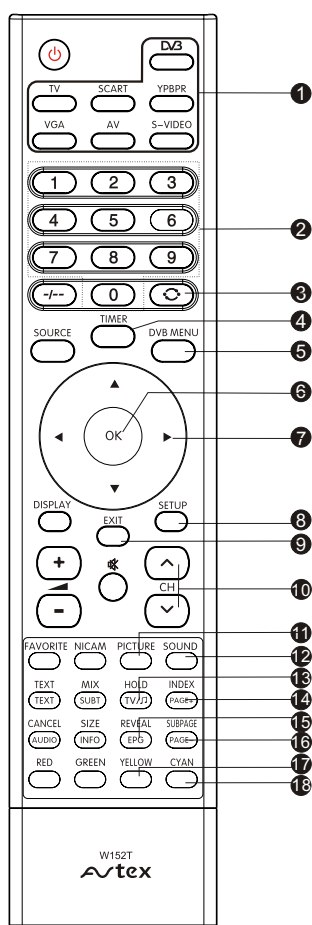

18 **CYAN**
CYAN button.

17 **YELLOW**
YELLOW button.

- 1** **Source selection**
Signal source select rapidly: DVB, TV, SCART, YPBPR, VGA, AV, S-VIDEO.
- 2** **Number buttons**
To select program number.
- 3** **RETURN**
To exchange channel between the previous program and the current program, valid in TV and DVB mode.
- 4** **TIMER**
To display the calendar and settings for timer of power on/off.
- 5** **DVB MENU**
To enter or return to the previous DVB menu and screen.
- 6** **OK button**
To confirm the selections.
- 7** **Left/Right cursor(menu adjustment)**
To move leftward/ rightward or adjust the selected item in the menu, or adjust sound volume.
- 8** **SETUP**
TV function setup.
- 9** **EXIT**
To exit the DVB menu.
- 10** **CHANNEL +/-**
To increase or decrease program number valid in TV mode.
- 11** **PICTURE**
To select different picture mode: User, Standard, Dynamic, Soft. (only valid in TV, AV, SCART, S-VIDEO, YPBPR mode)
- 12** **SOUND**
To select different sound field modes: User, Music, Film, News, Standard.
- 13** **HOLD/TV/□**
To stop teletext on current page/Switch between TV and radio modes, valid in DVB mode.
- 14** **INDEX/PAGE+**
To display main content page when playing the teletext /Change to the program in next page.
- 15** **REVEAL/EPG**
Display the hidden teletext information /To display the program guide(valid in DVB mode).
- 16** **SUBPAGE/PAGE-**
To display the subpage of the teletext/Change to the program in previous page.

REMOTE CONTROLLER

- 19 **STANDBY**
To switch between standby mode and power-on mode.
- 20 **Two-digit number button**
To switch between one or two-digit program number.
- 21 **SOURCE**
To select input source: TV, DVB, SCART, YPBPR, VGA, AV and S-VIDEO .
- 22 **UP/DOWN cursor**
To select upward/downward in the menu or change the channel.
- 23 **DISPLAY**
To display source information.
- 24 **MUTE**
Sound mute switch.
- 25 **Volume +/-**
To increase or decrease sound volume.
- 26 **NICAM**
Switch in NICAM, A2 and mono channel (It is effective in TV signal input with NICAM or A2 function) .
- 27 **FAVORITE**
Display your favorite channel list, valid in DVB mode.
- 28 **TEXT/TEXT**
To enable or disable the function of teletext.
- 29 **MIX/SUBT**
To display TV and teletext in the same time/
Selects the subtitle language .
- 30 **CANCEL/AUDIO**
To cancel teletext/To change the audio language and sound track, valid in DVB mode .
- 31 **SIZE/INFO**
To magnify teletext page/To display the information about channel and program, valid in DVB mode.
- 32 **RED**
RED button.
- 33 **GREEN**
Green button.

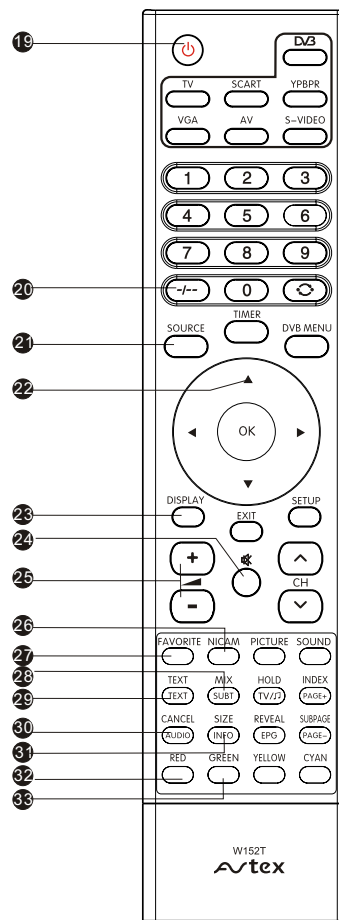

REMOTE CONTROLLER

BATTERY INSTALLATION

Remove the battery cover. Insert two SUM-4(AAA) batteries matching the -/+ polarities of the battery to the -/+ marks inside the battery compartment, as follows:

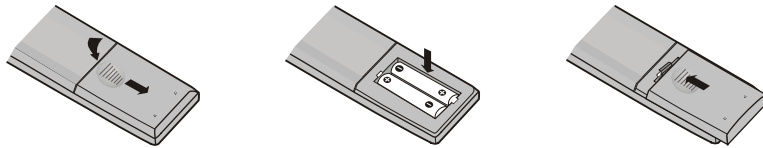

BATTERY LIFE

- Generally speaking, the battery may be used for one year, but the battery life is also related to the usage times and remote controller operation.
- If the remote controller is still invalid when very near to the remote sensor window, please replace the battery.
- Please use SUM-4(AAA) battery.

NOTES

- Never use rechargeable battery.
- Never charge, short-circuit, disassemble and heat the battery, or throw it into fire.
- Pay attention not to fall or knock the remote controller, which will cause damage or function failure to it.
- Do not use new and old battery together.
- When not using the remote controller for a long time, please take out battery to avoid liquid leakage. Before replacing new battery, please clean the electrolyte in the remote controller.
- If electrolyte splashes into body, please clean it with water.

CAUTION:

Please put battery in the place children cannot touch. If swallow by accident, please contact with the local doctor immediately.

LET'S START

After this unit is well fixed on the desk or on the wall, and the cords are well connected for input or output, what you should do next is:

First, connect the adapter to the LCD TV, then the unit will go into standby mode, and you can see the indicator goes into red.

Second, press [STANDBY] key on the left side of the LCD TV or [STANDBY] button on the remote control to make the unit switch into working mode, and you will see the indicator turn green. Now you can enjoy all exciting features of the whole new product.

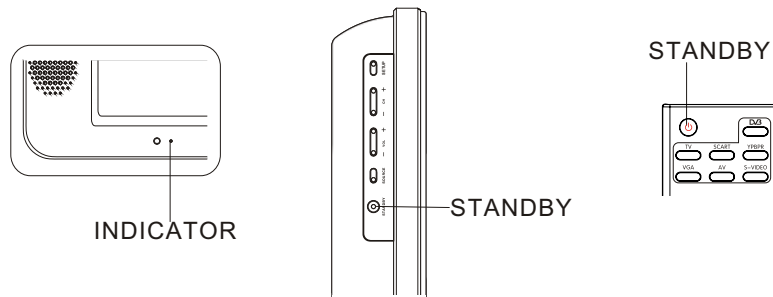

CHANGE SOURCE OPERATION

You can change input source by using Source Menu. Press [SOURCE] button or [SOURCE] key to show the menu as follows:

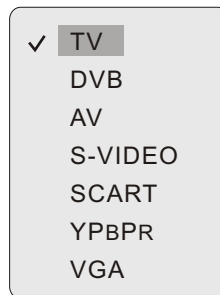

The current source item is highlighted. Through press [▲/▼] button on the remote control or [CH+/CH-] key on the left side of LCD TV to select your desire, Press [◀/▶] button, [VOL+/VOL-] key or [OK] button to confirm your choice.

TV MENU SETUP

This product can store up to 100-channel programs (0~99). You can select your favorite channel through [CH+/-] or number buttons, and you can scan and store all of the channels through manual or automatic mode.

In TV mode, press [SETUP] button into the main menu and the main menu will show as follows:

- Through pressing [▲/▼] button on the remote control, you can select main menu sections (main menu sections consist of " PICTURE ", " SOUND ", " TV SETTING ", " SYSTEM SETTING "). Press [▶] or [OK] button to enter this menu section.
- Press [▲/▼] button on the remote control to select the item, and then press [◀/▶] button to adjust parameter value. Press [SETUP] button to return to main menu sections.

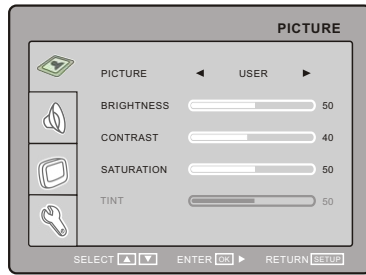

PICTURE

Select " " and menu will show as follows:

Press [▲/▼] button to select items and [◀/▶] button to adjust.

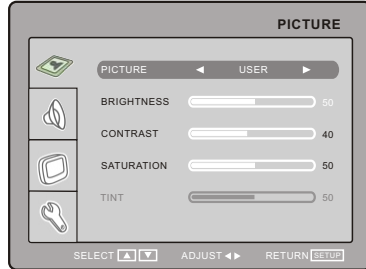

Item	Description
PICTURE	Can be change between : "USER ", "STANDARD ", "DYNAMIC " and "SOFT".
BRIGHTNESS	To adjust brightness.
CONTRAST	To adjust contrast.
SATURATION	To adjust color saturation.
TINT	To adjust picture tint, only valid in N 3.58/N 4.43/PAL60 and display mode with V-scanning frequency equal 59.94 (please refer to P33).

TV MENU SETUP

SOUND

Select "🔊" and menu will show as follows:

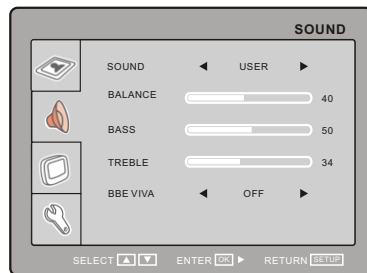

- Press [▲/▼] button to select item and press [◀/▶] button to adjust . The following is sound item description.

Item	Description
SOUND	Can be change between "USER", "MUSIC", "STANDARD", "FILM" and "NEWS" .
BALANCE	To adjust balance of left and right channels.
BASS	To adjust bass.
TREBLE	To adjust treble.
BBE VIVA	To adjust BBE mode (with bass and treble invalid)

TV MENU SETUP

TV SETTING

Select "  " and tuning menu will show as follows:



- Press [▲/▼] button to select item and press [◀/▶] button to adjust or activate.

Item	Description
CHANNEL	To change the channel number.
CHANNEL EDIT	To enter a submenu to set channel skip and channel swap. Please refer the next page.
FINE TUNE	To adjust the channel frequency accurately to make the sound and picture effect better.
MANUAL SEARCH	To scan programs by manual.
AUTO SEARCH	To scan programs and store all of them automatically.

NOTE

During the searching, you can press [SETUP] button to stop.

TV MENU SETUP



Item	Description
CHANNEL	To select current channel here.
SKIP	To select "Yes " or "No ", you can select "Yes " to make current channel unaccessible while using [CH+/-] button to browse channels.
SWAP	Select or enter the channel number directly to swap with current channel.
OK	Highlight this option and press the [OK] button to confirm the swap function.

TV MENU SETUP

SYSTEM SETTING

You can setup some system configuration here.

Press [▲/▼] to select "🔧" item and press [▶] or [OK] button to enter the following section:

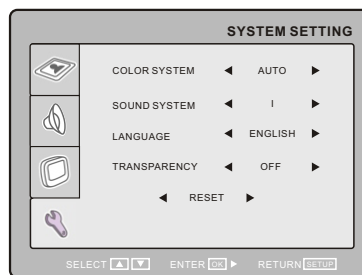

- Press [▲/▼] button to select item and press [◀/▶] button to adjust or activate.

Item	Description
COLOR SYSTEM	Can be changed between: "Auto", "PAL" and "SECAM".
SOUND SYSTEM	Can be changed between: "BG", "DK", "I" and "L" .
LANGUAGE	Select OSD language.
TRANSPARENCY	To change transparency of OSD.
RESET	To reset all value to default.

NOTES

- Which "COLOR SYSTEM" mode and "SOUND SYSTEM" mode to use is related to your local TV broadcasting system.
- SECAM system is only used by some European countries and districts, such as France.
- If the local system is SECAM L, the color system must be selected as "SECAM" and sound system must be selected as "L".

TV MENU SETUP

NICAM/BILINGUAL RECEIVING

If you can receive Nicam/bilingual signal, you can operate as follows to enjoy that.

- You can select Nicam stereo, mono channel or bilingual through NICAM button on the remote control. If stereo signal is too weak, this unit will switch into mono channel automatically.
- When selecting mono channel, "MONO" will show on screen; when selecting bilingual, "DUAL1" will show on screen; when selecting bilingual II, "DUAL 2" will show on screen and when selecting stereo, "STEREO" will show on screen.

NOTE

Nicam/bilingual function is only effective in TV mode while program coming with Nicam/bilingual.

TELETEXT FUNCTION

Most TV stations provide cost-free teletext information, including the latest news, weather information, TV program list and stock information, etc. You just input the needed teletext page according to the teletext content.

TELETEXT DISPLAY

- ◆ Select the channel with teletext signal;
- ◆ Press [TEXT] button;
- ◆ Select the corresponding page according to the colorized buttons on the remote control;
- ◆ Press [TEXT] again and TV screen will display.

PAGE SELECTION

- ◆ You can input 3 digital numbers to enter the page you want to watch through number buttons. If the inputted number is invalid, you need to input correct 3 digital numbers again after you finished inputting this 3 digital numbers.
- ◆ You can select to turn pages forward or backward through [CH+/-] button.

MIX MODE

This function may let you enjoy TV and teletext information at the same time.

- ◆ When a certain teletext page displays, press [MIX] button, TV and teletext information will display on screen at the same time.
- ◆ Press [MIX] button again and only teletext image displays.
- ◆ In mix mode, the disturbance lines on teletext characters are easy to appear, so you are not recommended to select this mode.

NOTE

Press [CANCEL] button to exit teletext.

LOCK

You can press [HOLD] button to lock teletext page. Press this button again to cancel locking.

INDEX

Pressing [INDEX] button to display content page.
Enter a certain teletext page through inputting number buttons.

TELETEXT FUNCTION

ZOOM IN TELETEXT

- ◆ When teletext page shows, you may double zoom in to display this teletext page;
- ◆ Press [SIZE] button to zoom in the upper half part of teletext page;
- ◆ Press [SIZE] button again to enter the under half part of teletext page;
- ◆ Press this button for the third time to return to original display mode.

DISPLAY MODE

Press [REVEAL] button to display the hidden teletext information. Press this button again to cancel teletext information displaying.

SUBPAGE

User could press [SUBPAGE] button to select to the subpage of teletext.

COLORIZED BUTTONS (RED, YELLOW, GREEN, CYAN)

Select the corresponding teletext page through colorized buttons.

AV, S-VIDEO, SCART AND YPBPR SETUP

VIDEO SETTING MENU

When in AV/S-VIDEO/SCART input mode, there are 6 color system modes for selection: "Auto", "PAL", "N 3.58", "N 4.43", "PAL60" and "SECAM". Select the right system for your video program. If you do not know which mode your video playback devices and video media is using, you should select the auto mode or you should check and confirm this with your supplier.

The menu setup of AV/S-VIDEO/SCART modes is much the same as that of TV mode, except the " "section is invalid and a little difference in color and sound modes. In order to make this manual pithy and concise, it is not repeated here. You can find it in preceding pages.

And the menu setup of YPBPR is the same as that of VGA menu, except ' "section. Please refer to posterior pages. The " "section YPBPR used is the same as that of TV mode. Please refer to P9 for it.

NOTE

If no signal input in TV, AV, S-VIDEO, SCART, YPBPR, the screen will show like the following figure.

This unit will go into standby mode automatically with no signal input for more than 5 minutes.

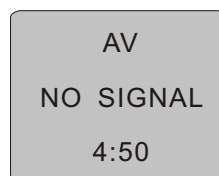

- If the input channel is SCART, this unit will automatically recognise RGB or CVBS signal of SCART; when normal RGB signal appears, this unit will automatically switch into RGB display mode. For this unit is combined by multiple functions, when inserting into SCART socket, it will not automatically switch into SCART mode. You have to select SCART channel through [SOURCE] menu, that is a little different with that of others TV set.

VGA SETUP

With the VGA mode supported up to 1024*768@75Hz, and speakers built in, you can use this unit as a multimedia PC monitor. When this unit works in VGA mode, the following setup can be done.

Press [SETUP] button to enter main section. Press [▲/▼] button to select sections and then press [▶] button or [OK] button to enter. If all is done, please press [SETUP] button twice to exit and your setup data will be saved automatically.

PICTURE

Press [▲/▼] button to select "🖥️", and press [▶/OK] button to enter.

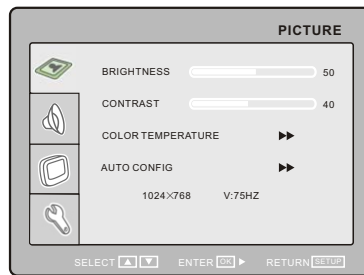

Press [◀/▶] button to adjust value of item.

Item	Description
BRIGHTNESS	To adjust brightness of picture .
CONTRAST	To adjust contrast of picture .
COLOR TEMPERATURE	Enter sub menu to adjust color temperature of picture. Press [◀/▶/OK] button to enter.
AUTO CONFIG	Auto config horizontal/vertical position, phase and frequency. Press [◀/▶/OK] button to activate.
STATUS	You can see some information about the input video here.

VGA SETUP

Here shows the color temperature submenu.

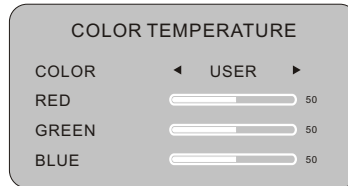

Press [▲/▼] button to select item and press [◀/▶] button to change and adjust value of item.

Item	Description
COLOR	Select color temperature mode : "User", "C6500", "C8700", "C9300".
RED	Adjust red value of color temperature
GREEN	Adjust green value of color temperature
BLUE	Adjust blue value of color temperature

SOUND

Press [▲/▼] button to select "🔊" and press [▶/OK] button to enter.

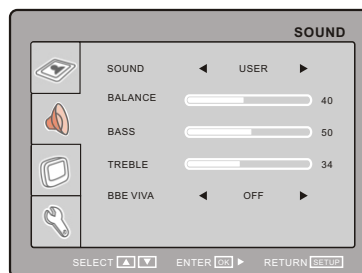

The operation of sound section here is the same as that in TV mode. Please refer to P10.

VGA SETUP

MONITOR SETTING

Press [▲/▼] button to select " " and press [▶] or [OK] button to enter.

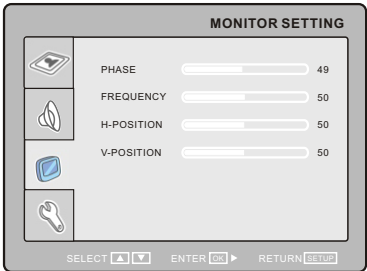

Press [▲/▼] button to select item and press [◀/▶] button to adjust value of item.

Item	Description
PHASE	To adjust phase.
FREQUENCY	To adjust frequency
H-POSITION	To adjust screen horizontal position
V-POSITION	To adjust screen vertical position

NOTE

If you use this unit as a PC-monitor, and when your PC goes into standby mode, the screen will show as dexter. This unit will go into sleep mode with no signal inputted in 2 minutes. In this mode, the indicator will remain green, and the screen is turned off. You can wake it up by waking up your PC or pressing [SETUP] or [SOURCE] button in the remote control.



VGA SETUP

FUNCTION

Press [▲/▼] button to select "🔧", and press [▶] or [OK] button to enter.

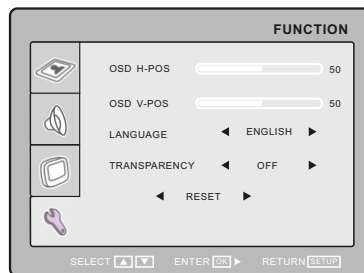

Press [◀/▶] button to adjust value of item.

Item	Description
OSD H-POS	To adjust the horizontal position of OSD
OSD V-POS	To adjust the vertical position of OSD
LANGUAGE	Select OSD language [English]
TRANSPARENCY	To adjust transparency of OSD. it can be change from OFF to LEVEL6, 7 levels in total.
RESET	Reset all value that related to picture and sound to default .

TIMER SETTINGS

TIMER SETTING

At any display mode you press [TIMER] button, calendar will show on the screen:



Item	Description
SET TIME	Press [▶ /OK] button to go to the set time sub menu.
SET TIMER ON	Press [▶ /OK] button to go to the set timer on sub menu.
SET TIMER OFF	Press [▶ /OK] button to go to the set timer off sub menu.

Use [▲/▼] button to choose which value to change and use [◀/▶] button to change it. When new value is set, press [TIMER] or [OK] button to exit and the value will be saved immediately.

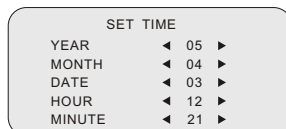

With "TIMER ON" function, you can waken on this unit at a certain time from standby mode. You can go into "SET TIMER ON" sub menu by pressing [◀/▶/OK] button when cursor pointing at "SET TIMER ON". There are 3 items in this sub section.

You can set two timers for power on. That means you can power on your LCD TV two times a day automatically.

You can set the hour and minute for auto power on here.

- HOUR 1 and MINUTE 1 set for the TIMER 1 for auto power on, ACTIVATE 1 can be set for activate setting for TIMER 1.
- You can choose ON/OFF and ONCE on ACTIVATE 1.

When ON is selected, timer 1 will always enable auto powering on .

When you select OFF ,timer function will be disable .If you select "ONCE", timer 1 will enable auto powering on and, after it powers on automatically for the first time, the setting will go to "OFF" automatically.

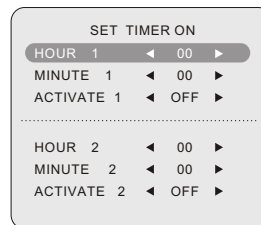

TIMER SETTINGS

HOUR 2 and MINUTE 2 set for the TIMER 2 for auto power on ,ACTIVATE 2 can be set for activate setting for TIMER 2.

- You can choose ON/OFF and ONCE on ACTIVATE 2.
- When ON is selected, timer 2 will always enable auto powering on . When you select OFF ,timer function will be disable .If you select "ONCE", timer 2 will enable auto powering on and, after it powers on automatically for the first time, the setting will go to "OFF" automatically.

With "TIMER OFF" function, this unit can power off by itself at a certain time from working mode.

You can go into "SET TIMER OFF" sub menu by pressing [◀/▶/OK] buttons when cursor pointing at "SET TIMER OFF" .There are 3 items in it .

- You can set the hour and minute for auto powering on here
- And you can set the "TIMER OFF " function activate option here. You can choose "ON/OFF" and "ONCE" here.

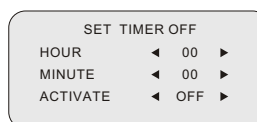

When "ON" is selected, timer will always enable auto powering off . When users select "OFF ", timer will disable powering off .

If you select "ONCE", timer will enable auto powering off and, after it powers off automatically for the first time, the setting will go to "OFF" automatically.

NOTE

- When you have set the "TIMER OFF" activated, a message will show when it is 1 minute left for powering off like: " STANDBY : 59S" . If you press [TIMER] button during this status, you can cancel the power off this time. When the number is decreased to 0, this unit will go to standby mode automatically .
- When you set the ACTIVATE ON or ONCE, and the calendar's time comes to the timer's value, power on and power off event will occur; For example: If you set the POWER ON TIMER to 9:00, ACTIVATE ON, then when time in calendar goes to 9:00, this unit will power on from standby mode automatically.

DVB OPERATION

Power on and switch signal source to DVB mode and the unit begins to work.

Press the [DVB MENU] button, the Main Menu will be displayed, in which you can set your preferences, Search for channels, edit the channels list or your favourite list, viewing Programme Guide Information, etc.

It is easy to see that the Main Menu is composed of six parts: General Setting, Advanced Setting, Auto Search, Manual Search, Channel Setting, EPG.

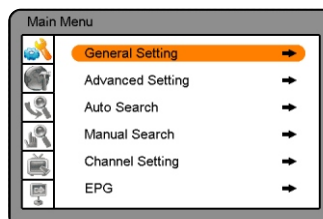

Note: Select different item using the [▲/▼] button, and press [OK] button to enter it.

GENERAL SETTING

You can set censorship, Language, and all other items suitable for your environment.

Note: Press [OK] button to enter the following menu. Press the [DVB MENU] button to return to the previous menu or to exit the menu screen.

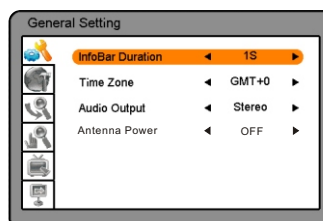

InfoBar Duration

When you switch channels, the infobar will be automatically displayed, but it will hide after a few seconds. You can set the duration during which the infobar is to be displayed.

- 1s the infobar will automatically hide after 1 second
- 3s the infobar will automatically hide after 3 second
- 5s the infobar will automatically hide after 5 second
- 7s the infobar will automatically hide after 7 second
- 9s the infobar will automatically hide after 9 second

Note: If you press the [INFO] button to display the infobar, it will not automatically hide. You should press the [INFO] button again to hide it.

Time zone

To choose your time zone, it is set depending on your country. The current time is set automatically whenever GMT Offset changes.

Note: It may have been setup in **Installation Wizard** step 1 When you powered on the receiver for the first time after purchasing.

Audio Output

You can set the Audio output, select one option from **Stereo / Left/Right/Mono**.

Antenna Power

Choose **ON**, if you have an active ANTENNA but without an external DC supply. In this case, the ANTENNA will be powered by the receiver.

DVB OPERATION

Choose **OFF** to shut off the Antenna power ,if you have a passive or a self powered active ANTENNA .

Warning: You should never shortcut the antenna jack, it may cause injury or damage some unit.
The receiver is only able to supply **DC 5V/50mA(MAX)**, never connect heavy load to the receiver, it may cause damage.

ADVANCED SETTING

You can set parental control for each programme . You can also change your password.

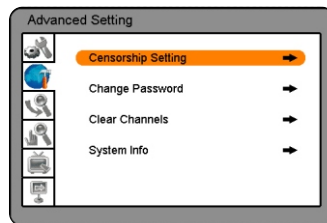

Note: When a prompting message is displayed to request your password, enter the password using the **Number(0-9)** button, then press [OK] button to enter.

Censorship setting

Censorship Classification allows you to block programmes according to the age level you have set.

View All All programmes can be watched because there is no age limitation.

- 7** Programmes are blocked for children under the age of 7.
- 10** Programmes are blocked for children under the age of 10.
- 14** Programmes are blocked for children under the age of 14.
- 16** Programmes are blocked for children under the age of 16.
- 18** Programmes are blocked for children under the age of 18.

Note: You have to enter Password to watch the programme which is blocked by the age level.

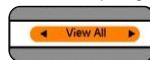

Change Password

Press the [▶] or [OK] button to change password.

New Password

Enter **New Password** using the **NUMBER(0-9)** button.



Enter Again

Enter the **New Password** again to confirm the **Verify Password**.

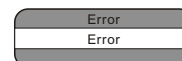
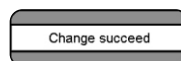

DVB OPERATION

Note: The Default Password is "000000". If you have forgotten your Password, please contact your local product distributor.

Clear Channels

If you just want to delete the Channel List, select the **Clear Channels** item.

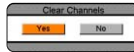

1. Select the **Clear Channels** item using the [►] or press [OK] button.
2. A prompting message will be displayed to request your confirm, select **YES** and press the [OK] button to confirm.
3. Select **NO** or press the [DVB MENU] button to return if you want to abort.

System Info

You can select to view all system information.

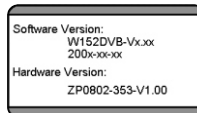

AUTO SEARCH

If your receiver is connected to the aerial and television, you can automatically search channels without entering any other information.

Select the **Auto Search** item using the [►] or press [OK] button to start searching. The searching result will be displayed in the **Search Result** window.

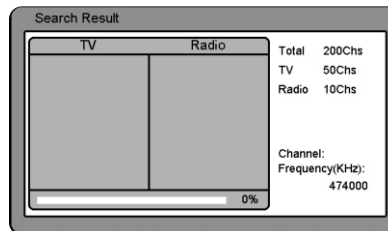

Wait while the receiver searches for the channels, this may take a few minutes.

Note: If you press the [DVB MENU] button during searching, the operation is stopped and the channels found until then will be saved.

If search operation is successfully completed, and the channel does not exist, try to reset the search operation again if necessary.

Warning: Once you press [OK] button to start auto search operation, all the saved channels will be cleared.

DVB OPERATION

MANUAL SEARCH

You can search channels manually by searching parameters.

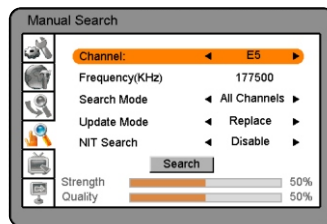

Note: Select different item using the [▲/▼] button, Press the [◀/▶] button to do your setting.

Press the [DVB MENU] button to save the changes and return to the previous menu.

Channel

Select your desired frequency channel to search using the [◀/▶] button. When entering frequency channel value, the appropriate frequency value is entered.

Frequency

Enter the your desired frequency to search directly by using the number(0~9) button.

Search Mode

Switch the Search Mode between **All Channels** and **Free Channels**.

All Channels When search operation is successfully completed, all the channels found will be saved.

Free Channels When search operation is successfully completed, only the free channels will be saved.

Update Mode

Switch the Search Mode between **Replace** and **Append**.

Replace Before start searching new channels, all the saved channels will be cleared first.

Append The saved channels will not be deleted .

NIT Search

If specified frequency channel information and other channel information are provided together the channel which belongs to other frequency channel, is also searched.

Select either **Enable** or **Disable** the NIT Search.

DVB OPERATION

After finishing all the setting above, select the **Search** item to start searching.
The searching result will be displayed in the **Search Result** window.

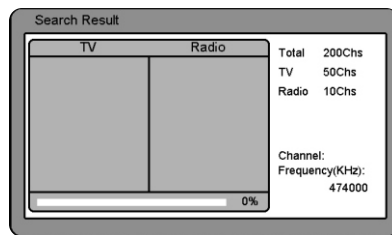

Note: If you press the [DVB MENU] button during searching, the operation is stopped and the channels found until then will be saved.

If search operation is successfully completed, and the channel does not exist, try to reset the search operation again if necessary.

CHANNEL SETTING

This chapter describes how to edit channels.

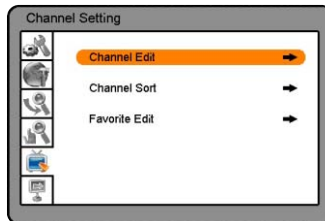

Note: Press [▶] or [OK] button to enter the following menu. Press the [DVB MENU] button to return to the previous menu.

Channel Edit

You can edit all channels in the Channel list.



Note: Select the different edit modes (delete and move) using the the [◀/▶] button.

DVB OPERATION

Channel Sort

You can sort all TV or Radio channel lists by channel ,name or free/scrambled.

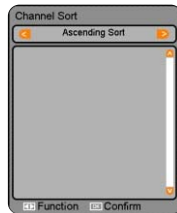

Note: Select the different sort ways using the [◀/▶] button, then press [OK] button to confirm.

Ascending Sort Channel lists are sorted by channel name from **A** to **Z**.

Descending Sort Channel lists are sorted by channel name from **Z** to **A**.

Free First Free channels will be placed on the top of the list.

Scrambled First Scrambled channels will be placed on the top of the list.

Favourite Edit

You can edit Favourite channel .



Press [OK] button select you favourite channel ,and press [OK] button to set the you selected channel as favourite channel .

EPG

The Programme Guide displays programme information about each channel, based on the date and time.

You can press [▲/▼] button to switch the channel, and press [◀/▶] button to view the current day or the next day programs and information, if there is the current day and the next day program and information.

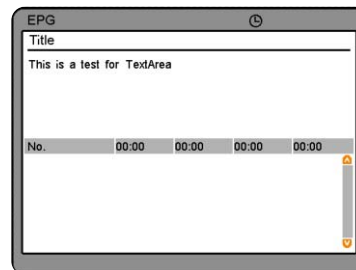

TROUBLESHOOTING

Please check for causes of problems in accordance with the following chart before contacting any maintenance personnel.

DISPLAY TROUBLESHOOTING

Symptom	Causes and Correction
Black screen, power indicator light off	◆ Check whether power cord is well connected, and whether this unit is power on
	◆ Check whether the signal cord of input device is well connected ◆ Check whether input device is power on
Image display flicker, unstable	◆ Check whether the input device signal is in this unit's specification
	◆ Check computer output mode: control panel-display-setup ◆ If the setup does not accord with this unit's specification, please change the display setup
	◆ Hor scanning frequency: 30kHz~75kHz ◆ Ver scanning frequency: 50 Hz~75Hz ◆ Max display mode: 15":1024X768@75 Hz

SOUND AND TV TROUBLESHOOTING

Symptom	Causes and Correction
Cannot power on	◆ Please make sure the well connecting of power cord
No sound	◆ Please make sure the well connecting of audio cord
	◆ Check volume
	◆ Make sure there is nothing plugged in the headphone jack
Volume too low	◆ Check volume
	◆ If volume is still too low when adjusting volume to maximum, please check whether the input device is well set
Snowy picture	◆ Input antenna damaged or not well connected
Remote control failure	◆ Check whether remote control battery used up
	◆ Whether battery installation is correct
	◆ Whether obstacles exist between remote control and the unit's receiving window
	◆ Check whether receiving window has strong light

SPECIFICATIONS

◆ LCD screen	Size Display proportion Type Pixel distance View angle	15.0" (diagonal) 304.1 mm(H)X228.0 mm(V) TFT color 0.297 mm(H)X0.297mm(V) 80(L)/80(R)/80(T)/55(B)
◆ Frequency	Hor scanning frequency Ver scanning frequency Display color	30 kHz~75 kHz 50 Hz~75 Hz 16.7M (color)
◆ Display mode	Recommended mode Max mode	1024X768@75 Hz
Panel Life	Hours	50,000
Input signal	Synchronous signal Video signal	H/V separation, TTL positive/negative; H/V composite, TTL positive/negative Green synchronous, 0.3V _p , negative 0.7 V _p @75ohm
TV/Video	Image system Audio system Video form	PAL/SECAM/NTSC(In video mode) DK/I/BG/L CVBS、S-VHS, RGB, YPbPr, VGA
Power Supply	Adapter input Adapter output	~ 100V-240V (50 /60 Hz) = 12V/4.5A
Unit/net weight (LXWXH)		438.7mmX163.1mmX295.7mm/5.5kg
Environmental factor	Working temperature Working humidity Storing temperature Storing humidity	5°C ~ 35°C 10%~80% -20°C~ 45 °C 5%~95%
Audio parameter	Audio input Frequency response	φ 3.5 jack(L,R), 0.5±0.3 Vrms TV signal: 100 Hz~12 kHz(-3dB) AV: 100 Hz~15 kHz (-3dB)
DVB	Input connector RF Loop through output connector Frequency range(VHF/UHF) Frequency range(VHF/UHF)	IEC-Type, IEC 169-2, Female IEC-Type, IEC 169-2, Male (loop throughout) 174M Hz~858MHz 7&8MHz

Hint: the items with "◆" symbol are related to LCD screen. Specifications and design are subject to change without notice.

- As for weight and size, please take actual object as standard.

DISPLAY MODE

SUPPORTED PC INPUT MODE				
Resolution	Hor scanning frequency (KHz)	Ver scanning frequency (Hz)	Pixel frequency (MHz)	Format
640×350	31.5	70.0	25.17	DOS
720×400	31.5	70.0	28.32	DOS
640×480	31.5	60.0	25.18	DOS
640×480	37.9	72.0	31.50	VESA
640×480	37.5	75.0	31.50	VESA
800×600	35.1	56.2	36.00	VESA
800×600	37.9	60.0	40.00	VESA
800×600	48.1	72.0	50.00	VESA
800×600	46.9	75.0	49.50	VESA
1024×768	48.4	60.0	65.00	VESA
1024×768	56.5	70.11	75.00	VESA
1024×768	60.0	75.0	78.75	VESA

NOTES

- This product does not support the display mode not listed above. In order to achieve the best display effect, please select the above-listed 12 display modes input signal.
- Because of the difference of display card output signal (especially non-standard signal output), the display image may appear little disturbance which can be adjusted through " AUTO CONFIG " in the "PICTURE" menu by users.
- To prolong this unit's service life, you are suggested to use power management function of computer.

DISPLAY MODE



SUPPORTED VIDEO INPUT MODE			
Format	Hor scanning frequency	Ver scanning frequency	Vert scantype
720X480	31.47	59.94	480P
720X480	15.734	59.94	480i
720X576	31.25	50	576P
720X576	15.625	50	576i

NOTE

Specifications and design are subject to change without notice.

ACCESSORIES

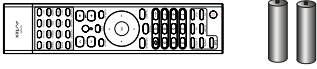
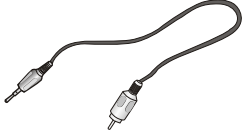
Please check the following accessories.

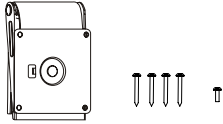
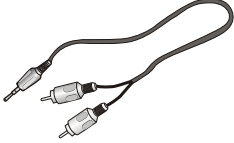
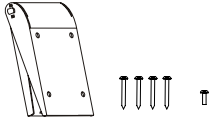
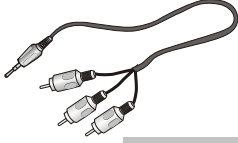
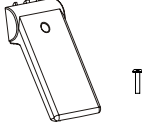
 <p>User manual</p>	 <p>Remote control and battery</p>
 <p>Coaxial digital audio cord</p>	 <p>Power adaptor</p>
 <p>Wall Mount Holder Kit AK556 (optional)</p>	 <p>Audio cord</p>
 <p>Wall Mount Holder Kit AK558 (optional)</p>	 <p>AV cord</p>
 <p>Kickstand Kit</p>	