



Dune HD Base 2.0

User Manual

Table of Contents

4 Key Features

- Player Features
- Media File Player
- Package Contents
- Copyright Notice
- Safety Measures
- Before Getting Started
- Exterior
- Installing the Internal HDD

9 Remote Control (RC)

- Entering Text with Remote Control
- Standby Mode

11 Connections

- Connecting a TV/Monitor/Projector with HDMI/DVI Input
- Connecting a TV/Monitor/Projector with Component (Y/Cb/Cr) Video Input
- Connecting a TV/Monitor/Projector with Composite Video Input
- Transmission of Digital Audio to AV Receiver via HDMI Input
- Transmission of Digital Audio to AV Receiver via Optical/Coaxial Cable
- Transmission of Analog Audio to External Stereo Amplifier (or TV Set)
- Transmission of Analog 7.1 Audio to External Amplifier (Receiver)
- Connection to LAN and Internet
- Connection of External USB Drives

16 System Setup

- Setup Menu
- Quick Setting of Video Output Mode
- Setup Menu Sections
- General
- Video
- Audio
- Network
- Information
- Miscellaneous

- Menu Style
- IPTV
- Internet Radio
- Web Browser
- Torrents
- Encodings

25 Playback

- File Browser
- Marking Files and Folders
- Copying and Moving Files and Folders
- File Playback
- Blu-ray Playback
- DVD-Video Playback
- Audio CD Playback
- Internet Radio Playback
- IPTV Playback and Recording
- HTTP Streams Playback
- Photo Viewer

36 Accessing Network Drives

- Connecting via SMB Protocol
- Connecting via NFS Protocol
- Accessing Player HDD from Network
- Connecting to the Player via FTP from a Windows PC
- Connecting to the Player via SMB from a Windows PC

39 Troubleshooting

- General
- Video Playback
- Network
- Reporting a Problem

43 Firmware Recovery Procedure

44 Player Specifications

45 Notes



Player Features

Media content playback

- Video (various formats), music (MP3 and others), and photos (JPEG and others).

Disc playback (when an external optical drive is connected)

- Audio CD, DVD-Video disc, Blu-ray disc (note: retail Blu-ray discs with AACs protection are not supported).

Streaming network content

- NFS and SMB protocols (plus limited HTTP support).

HDD mobile rack with SATA DirectLink for fast and easy HDD replacement

- HDD rack allows to store media collection on any number of hard disks without the need of expensive multi-disk NAS solutions. A standard 3.5" SATA HDD can be used, provided it has suitable heat emission. Please see http://dune-hd.com/support/hw_compat/ for recommendations on suitable HDD models.

HDMI 1.3

- Up-to-date HDMI 1.3 interface ensures outstanding quality and compatibility of digital video and audio signal.

Two USB 2.0 host ports

- Two high-speed USB 2.0 host ports ensure an easy-to-use playback of media content from external data storage devices like USB HDD, flash drives, card readers, etc. USB hubs are supported.

eSATA host port

- This high-speed port allows to plug an additional (external) HDD.

Optional extension modules

- One of the following internal modules may be installed: Wi-Fi 802.11n, Ethernet 1000 Mbps.

Media File Player

Media files playback is supported from the following media sources: internal SATA HDD, external USB or eSATA HDD, USB flash drive, USB card reader, optical discs (when a USB or eSATA optical drive is connected), network (HDD in a PC or NAS, some Internet sources).

Supported video codecs: MPEG-2, MPEG-4, DivX, Xvid, WMV 9, VC-1, H.264.

Supported video file formats: MKV, MPEG-TS, MPEG-PS, M2TS, VOB, AVI, MOV, MP4, QT, ASF, WMV, Blu-ray-ISO, BDMV, DVD-ISO, VIDEO_TS.

- ✓ For the best picture quality for viewing media files, the attached display should support 1920x1080 (1080p) or 1280x720 (720p) High Definition (HDTV) signal formats.

Package Contents



1

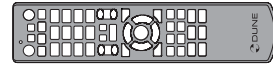

2



3

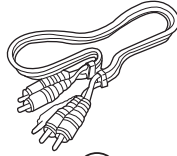

4

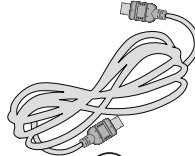

5



6

1. Dune HD Base 2.0 media player
2. Remote control (two AAA batteries are NOT included)
3. Power supply cord

4. AV cable
5. HDMI cable
6. This manual

Copyright Notice

The law prohibits copying, transmitting, displaying, broadcasting via cable network, public playback and letting on lease of copyright-protected materials without the rightholder's authorization. Some video discs are encoded with copy protection, and any picture recorded from such discs will be distorted. This product incorporates a copyright protection technology which is protected by requirements of certain U.S. patents and other intellectual property rights owned by Macrovision Corporation and other rights owners. Use of this copyright protection technology must be authorized by Macrovision Corporation and is intended for home viewing uses. Reverse engineering or disassembly is prohibited.

Safety Measures

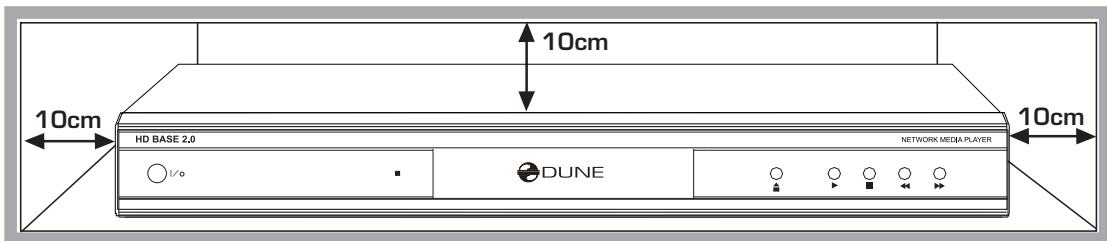

To Prevent Overheating



If you install your device in a closed space, it is necessary to provide enough clearance around it for proper cooling. The clearance at each side should be not less than 10 cm.



To avoid troubles, please read this manual carefully before using the device. Keep the manual for future reference.

1. In case of malfunctioning, please contact an authorized service center. There are no user-serviceable parts inside the device; only a qualified engineer may attempt repairing it. Opening the device case voids the warranty.
2. To avoid electric shock, do not touch the plugged-in player with wet hands and do not allow moisture within the case. If it happened, immediately unplug the device and contact an authorized service center.
3. Clean the device only with a dry soft cloth. Do not use any liquid detergents or scouring powder. In case of hard dirt, use special wipes suitable for PC cleaning. Make sure that the wipe is dry enough (otherwise fluid drops may get inside).
4. The device is intended for indoor use only. Do not expose it to direct sunlight, do not leave it near a heater or radiator.
5. Do not use the device in rooms with high humidity such as bathroom.
6. Do not plug in the player immediately after moving it from a cold place into a warm one; unpack it and leave for 1.5-2 hours in order to allow evaporation of condensate on internal parts.
7. Please make sure to switch off the player and all relevant AV equipment before connecting them.
8. Do not place any items on top of the player. The device needs some space for proper heat dissipation. Do not place any vessels with liquid close to the device.
9. Severe voltage surge in AC mains may result in improper operation of the device. In this case, please unplug the player or turn it off with the POWER button on the front panel of the player, wait for at least 15 seconds, then turn it back on. The media player will restart, and its functionality will be restored.
10. If you intend not to use the media player for a long period of time, for safety and power saving reasons please make sure to unplug it from the AC mains. Please be aware that in the standby mode the player still consumes significant power
11. After turning the player completely off using the power switch or unplugging it, please wait for at least 15 seconds before turning it on again.

Before Getting Started

When you start using the media player for the first time, please make sure that the shipping package is not damaged, has no compression or opening marks.

✓ If the package is damaged, the manufacturer shall not be held liable in respect of the integrity of the package contents.

When you connect the media player to your AV appliances for the first time, please make sure that all seals and retainer screws on the top enclosure are in place.

✓ If for some reason, the seals were broken, the manufacturer shall be entitled to refuse the free-of-charge after-sales servicing of the device (the warranty is void).

After switching on, the player performs automatic startup procedure, including boot-up of the embedded operating system. It may take about 1 minute. After that you will get to the Main screen (the file browser showing the root folder).



Please connect relevant AV appliances only if all devices are switched off. Please refer to the "Connections" section below for description of the majority of connections.

Exterior

Front view

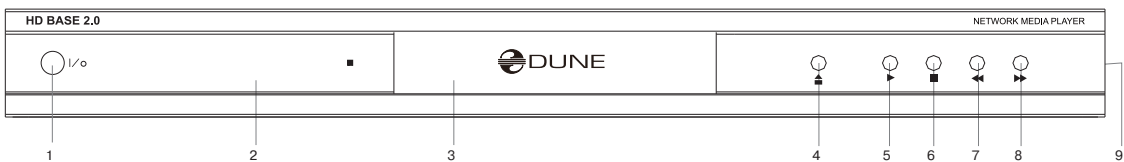

1. Power switch
2. Display
3. HDD rack

4. EJECT
5. PLAY/PAUSE
6. STOP

7. PREV
8. NEXT
9. USB 2.0 host

Rear view

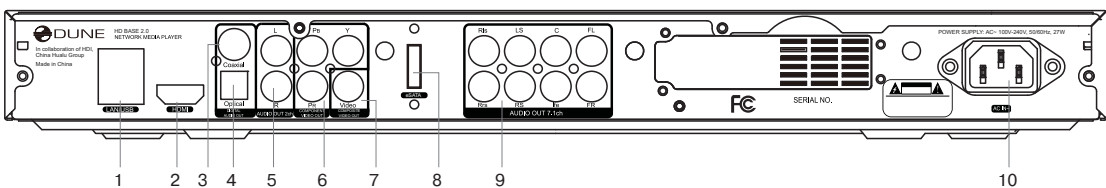

1. 100 Mbps LAN and USB 2.0 host
2. HDMI 1.3
3. Coaxial digital audio output
4. Optical digital audio output
5. Analog stereo (left/right) audio output

6. Component (Y/Pb/Pr) video output
7. Composite video output
8. eSATA host
9. Multichannel (7.1) analog audio output
10. AC power

Installing the Internal HDD

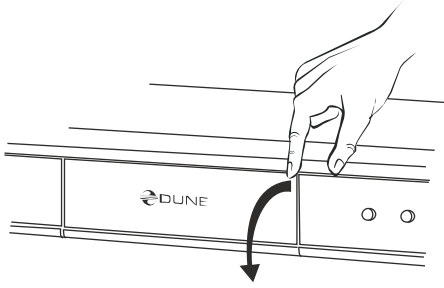

1. Push the cover at the right.

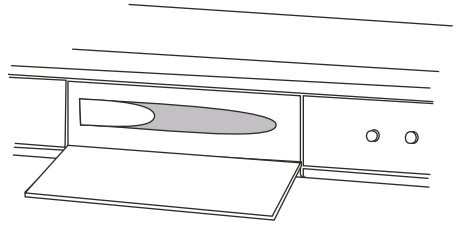

2. Open the cover.

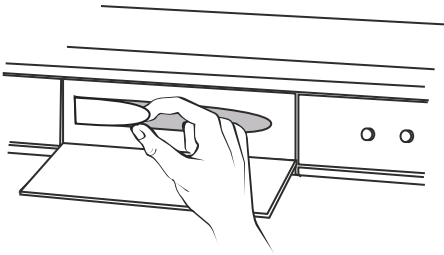

3. Pull the handle.

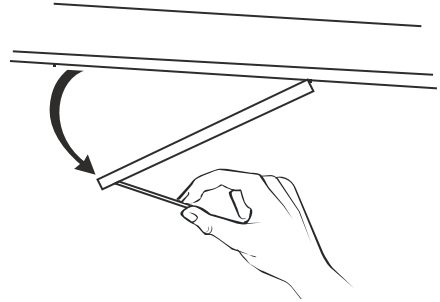

4. Open the door.

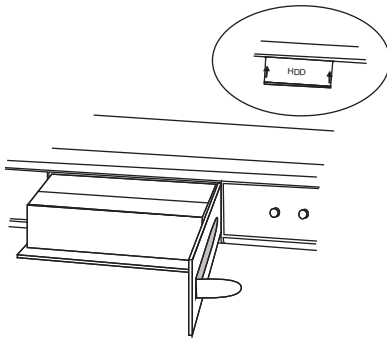

5. Insert an HDD.

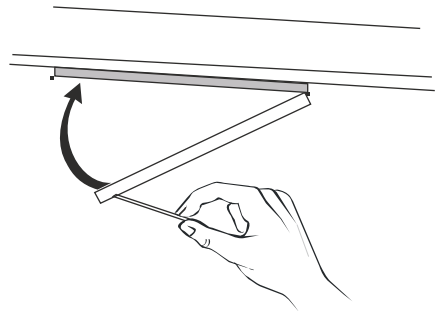

6. Close the door.



Completely power off the player (using the front panel power switch) before removing or installing the internal HDD. Switching the player to the Standby mode using the RC is not enough.



Remote Control (RC)

Chapter 2

1. **Command indicator** — flashes in response to RC button pressing.
2. **EJECT** — open/close the optical drive tray (if the external optical drive is connected). **MUTE** — turn the sound on/off. **MODE** — switch the video mode; control some other player functions. **POWER** — toggle the standby mode.
3. **A (Red), B (Green), C (Yellow), D (Blue)** — access Blu-ray disc features; control some other player functions.
4. **0–9** — enter numbers and text; control some other player functions.
5. **SEARCH** — jump to a specified playback position. **ZOOM** — change the zoom factor for the video content being played.
6. **V+ / V– (volume up / volume down)** — adjust the volume.
P+ / P– (page up / page down) — scroll up and down in various lists; control some other player functions.
7. **SETUP** — enter/leave the main Setup menu; adjust playback settings during playback.
8. **Arrows (LEFT, RIGHT, DOWN, UP), ENTER, RETURN, TOP MENU, POP UP MENU, INFO** — main buttons for controlling the player (navigate across the items on the screen, open/use the currently selected item, go back to the previous screen, go to main menu, show popup menu with actions, show information, control some other player functions).
9. **PLAY, PAUSE, STOP, SLOW, REW, FWD, PREV, NEXT** — control the playback.
10. **SUBTITLE, URL/2nd audio, ANGLE/ROTATE, REPEAT, SHUFFLE/PIP, AUDIO** — control the playback and some other player functions.

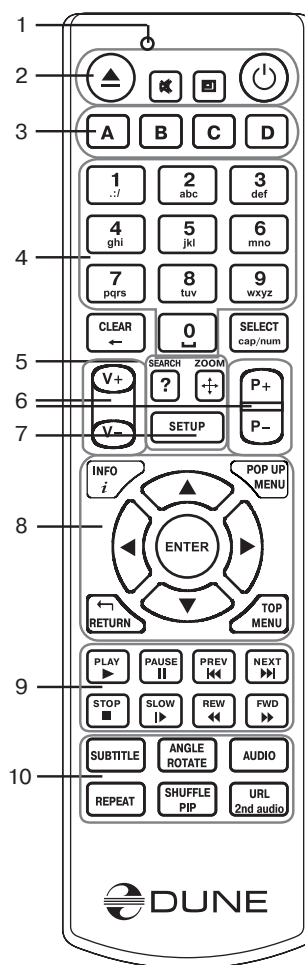

Some RC buttons may have several functions depending on the current player mode. Some RC buttons may be available only in certain player modes or only during playback of a certain content.

Notes:

- Use alkaline AAA batteries.
- Observe polarity when inserting batteries.
- Direct the remote control to the player. There must be no obstacles between the RC and the player. If the player is installed behind a tinted glass, the manufacturer may not guarantee an undisturbed functioning of RC.
- If RC functions only at short distances or stops functioning, make sure to replace the batteries.

Entering Text with Remote Control

Generally, entering text is carried out the same way as with most cell phones.

0, 1, 2, 3, 4, 5, 6, 7, 8, 9: Enter a character to the position pointed by the cursor.

First press: enter the first character from a set of characters related to this button. Each subsequent press: you may change the entered character to the next one from this set.

- 0: enter the space.
- 1: enter a special character (punctuation marks, etc).
- Up, Down, Left, Right after pressing 1 (special character entering mode): select the required character.

ENTER — confirm selection; finish text entering.

SUBTITLE — enter the period (for numeric mode); functions like button 1 (character mode).

CLEAR (<-) — delete a character to the left of cursor.

SELECT (cap|num) — switch input mode:

abc: character mode, small latin letters.



ABC: character mode, capital latin letters.

123: numeric mode, digits.

RETURN — cancel the text changes and finish text entering.

Left/Right — move the cursor one character left/right.

Up/Down — move the cursor to the start/end of a text line.

- If the cursor is already in start/end position: select another user interface element which is under/over the current text entry area (only for dialogs with several elements of user interface; text changes are confirmed automatically).

POP UP MENU — show context menu with a list of available commands. They allow you to cut, copy and paste text using the clipboard, much like it is done on a PC.

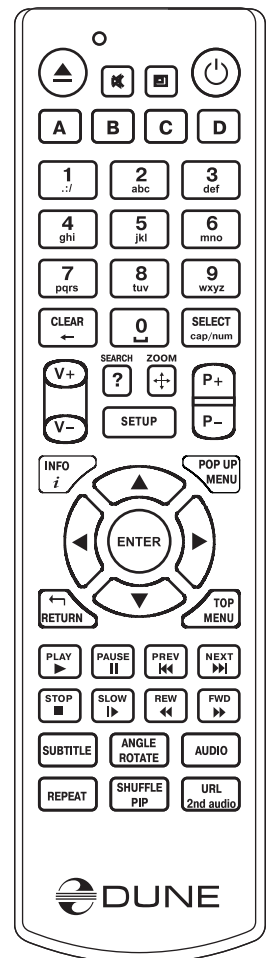

Standby Mode

Pressing the POWER remote control button switches the player to the Standby mode. In this mode the built-in HDD is turned off, as well as the video output, but the device does not switch off completely.

To activate the player from the Standby mode, press the **POWER** remote control button once again. The player will be switched on immediately (within several seconds).

*Note: you can also configure the player to power off completely when pressing the **POWER** remote control button (see Setup / Miscellaneous / Advanced / "POWER" remote button).*

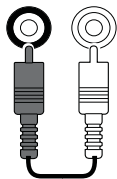

Connections

Chapter 3

This chapter describes different possibilities of connecting the media player to AV equipment.

- ✓ Depending on the model and the design of a TV/monitor/projector, after connecting it using one of the provided schemes and plugging in the power, the player initialization may take up to 10 sec. If after this time there is no picture (a "DUNE" logo) on the screen, then it is a problem with the cable connection or the TV/monitor/projector. Please check the "Troubleshooting" section in such case.

If, after the initial screen (a "DUNE" logo) disappears, there is no other picture on the screen in 10 sec and more, then it is most likely a problem of incorrect video mode set in the player. Please address the "Quick Setting of Video Output Mode" section below in such case.

Connecting a TV/Monitor/Projector with HDMI/DVI Input

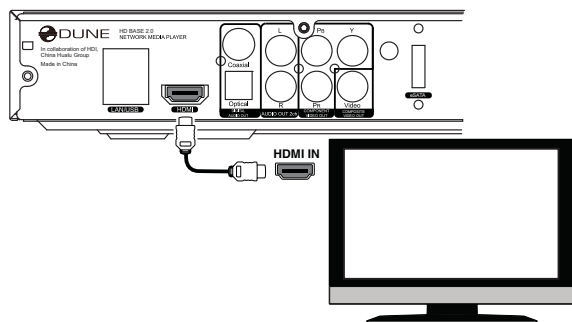

Since the player is designed first of all for playback of high definition (HD) video (up to 1080p), the best way of signal transmission from the player to a TV/monitor/projector is the HDMI interface. In this case, video and audio streams are transmitted in digital form, without loss, delivering excellent picture and sound.

- ✓ If your TV/monitor/projector has no HDMI port but is equipped with the DVI one, you can use an HDMI-DVI adapter (to be connected to HDMI-HDMI cable) or HDMI-DVI cable (no adapter needed). In this case, transmission of audio stream via HDMI is not supported, so one of the analog or digital audio outputs has to be used.

1. Make sure that the player and the TV/monitor/projector is switched off. Do not switch them on until the connection procedure is finished.
2. Connect the HDMI/DVI cable and (if needed) the HDMI-DVI adapter.
3. Using RC/buttons of the TV/monitor/projector, select the required input port and (for display mode). For further instructions please refer to the manual of your displaying equipment.
4. Power on the devices. Wait until the initial screen (a "Dune" logo) is shown.

Connecting a TV/Monitor/Projector with Component (Y/Cb/Cr) Video Input

For this connection you should use a 3RCA-3RCA video cable and (optionally) a 2RCA-2RCA audio cable for sound transmission to your TV set. Please note that video cable shall have an impedance of 75 Ohm, i.e. specially designed for transmission of analog video signal.

1. Make sure that the player and the displaying device are switched off. Do not switch them on until the connection procedure is finished.
2. Connect the component video output of the media player to the relevant TV/monitor/projector input using a 3RCA-3RCA cable.
3. Optionally connect the analog stereo audio output (AUDIO L/R) of the player to the relevant input of a TV/monitor/projector using a 2RCA-2RCA cable. Instead, you can use optical cable to transmit digital audio to your AV receiver; in this case better audio quality may be expected.
4. Using RC/buttons of TV/monitor/projector, select the required input and display mode. For further instructions please refer to the manual of your displaying equipment.
5. Power on the devices. Wait until the initial screen (a "Dune" logo) is shown.

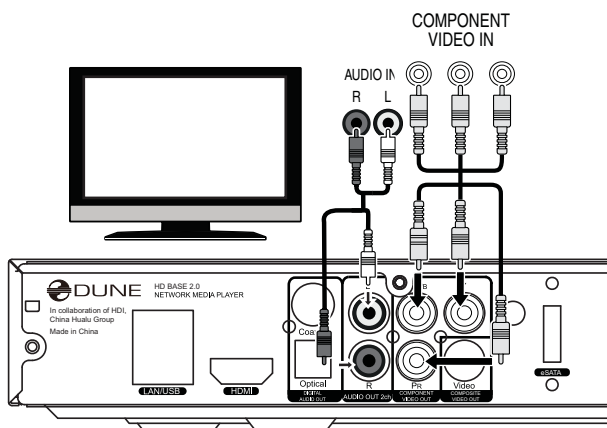

Connecting a TV/Monitor/Projector with Composite Video Input

Since this kind of connection does not provide a high-quality picture, we recommend to use it only in case your TV/monitor/projector does not have High Definition video interfaces, such as HDMI, DVI or Component (Y/Cb/Cr).

1. Make sure that the player the TV/monitor/projector are switched off. Do not switch them on until the connection procedure is finished.
2. Connect the media player to the relevant TV/monitor/projector input using an RCA-RCA cable.
3. Optionally connect the analog stereo audio output (AUDIO L/R) of the player to the relevant input of the TV/monitor/projector using a 2RCA-2RCA cable. Instead, you can use optical cable to transmit digital audio to your AV receiver; in this case better audio quality may be expected.
4. Using the RC/buttons of your TV/monitor/projector, select the required input and display mode. For further instructions please refer to the manual of your displaying equipment.

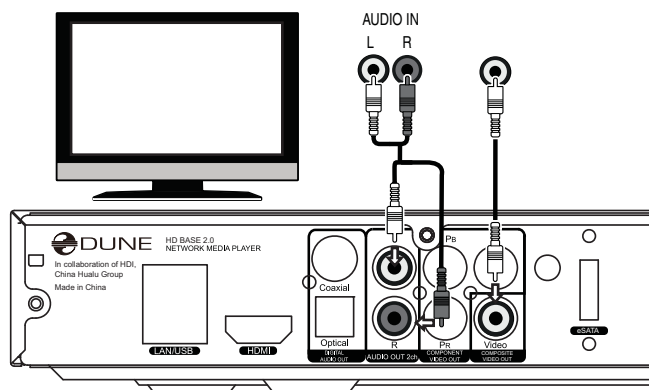

Transmission of Digital Audio to AV Receiver via HDMI Input

This media player is equipped with an up-to-date HDMI 1.3 interface, allowing transmission of digital video and audio streams via a single cable. If your AV receiver has an HDMI 1.3 input and decoders for up-to-date audio formats, you may fully enjoy an HD multichannel sound.

1. Make sure that the player and the AV receiver are switched off. Do not switch them on until the connection procedure is finished.
2. Connect the HDMI output of the media player to the HDMI input of your AV receiver using an HDMI-HDMI cable.
3. Using the RC/buttons of the AV receiver, select an appropriate mode (refer to your AV receiver manual).

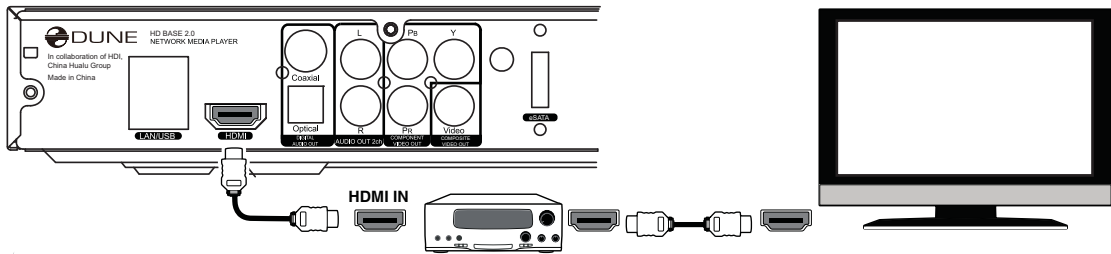

✓ We recommend you to turn down the volume of your audio equipment before connection, in order to protect your hearing from unexpectedly high volume, and to eliminate the risk of damage to your audio system.

Transmission of Digital Audio to AV Receiver via Optical/Coaxial Cable

An optical Toslink–Toslink or coaxial (75 Ohm) audio cable shall be used (not included).

1. Connect digital audio output of the player to the digital audio input of the AV receiver.
2. Select relevant input and sound mode on the AV receiver.

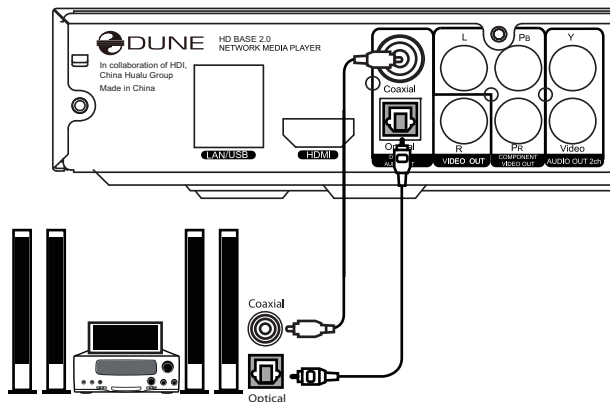

✓ We recommend you to turn down the volume of your audio equipment before connection, in order to protect your hearing from unexpectedly high volume, and to eliminate the risk of damage to your audio system.

Transmission of Analog Audio to External Stereo Amplifier (or TV Set)

An analog 2RCA-2RCA cable shall be used (not included).

1. Connect analog stereo audio output (AUDIO L/R) of your player to the audio input of your stereo amplifier.
2. Select a relevant input in your amplifier.

✓ We recommend you to turn down the volume of your audio equipment before connection, in order to protect your hearing from unexpectedly high volume, and to eliminate the risk of damage to your audio system.

✓ You may send the analog audio signal from your player to the TV set, in case you use DVI, Component video, or Composite video for video signal transmission and don't use an AV receiver for digital audio decoding. In case of connection via HDMI, video and audio signals will be transmitted using a single HDMI cable, that's why there is no need of additional analog audio connections in this case.

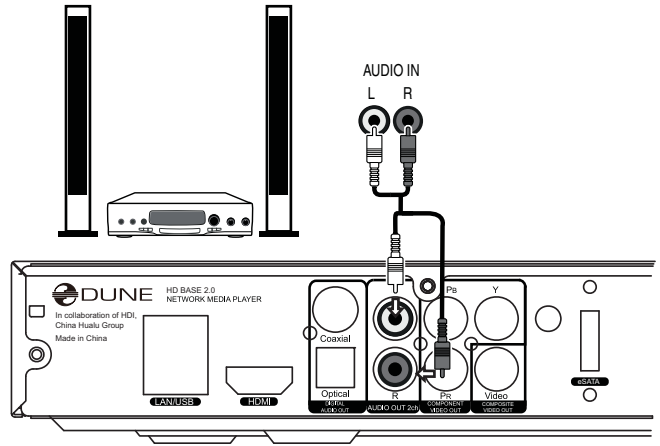

Transmission of Analog 7.1 Audio to External Amplifier (Receiver)

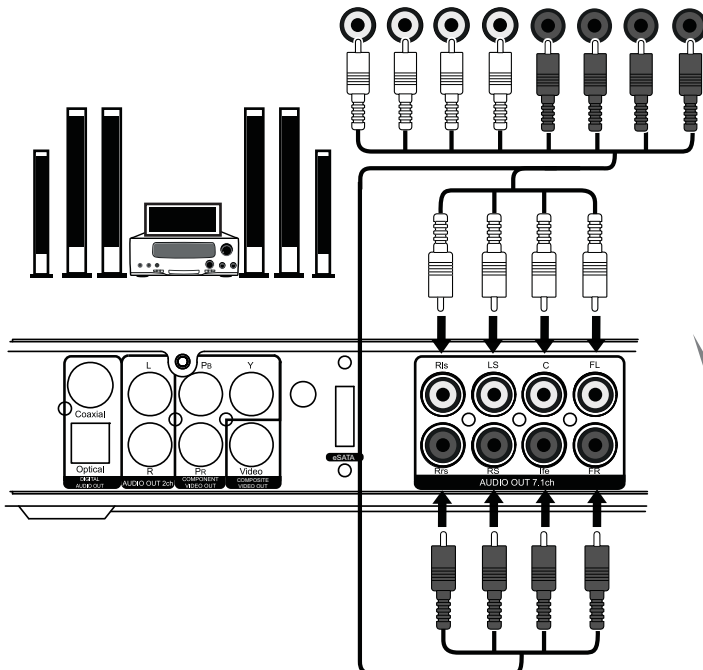

Four analog 2RCA-2RCA cables shall be used (not included). It is better to use four identical cables.

✓ We recommend you to turn down the volume of your audio equipment before connection, in order to protect your hearing from unexpectedly high volume, and to eliminate the risk of damage to your audio system.

Connection to LAN and Internet

A standard Cat.5, Cat.5e or Cat.6 Ethernet cable with RJ-45 connectors should be used (not included).

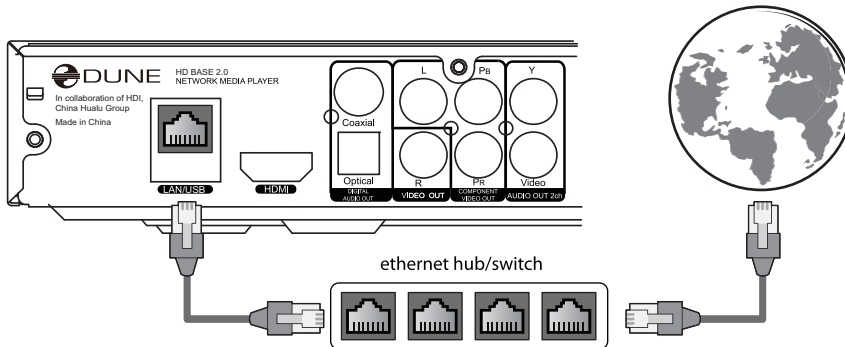

Connection of External USB Drives

Your media player is equipped with USB ports for connection of external data storage devices with USB interface. There are two standard A-type USB 2.0 host ports.

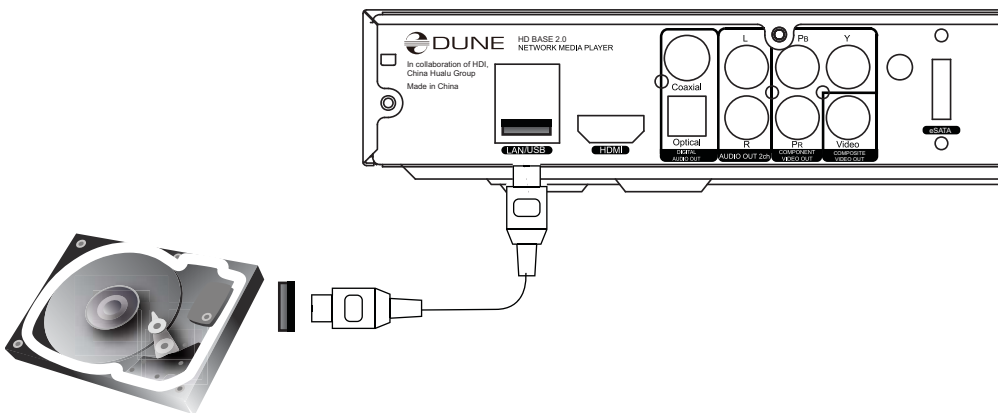

1. Connect a USB cable of external device to your media player.
2. Wait until the file browser shows a new corresponding icon in the root folder; this indicates that the connected equipment is initialized.

✓ Playback and other operations with USB drives are described in the "Playback" section below.



This chapter describes a list of settings of different functions of your media player.

Setup Menu

- The setup menu may be entered only from the file browser mode.



WARNING: During media files playback, an access to the setup menu is disabled. In order to enter the menu you need to stop the playback first.

- To enter the setup menu, press **SETUP** on your RC or enter the Setup folder in the Main screen of the player (the file browser showing the root folder).
- To exit the setup menu, press **SETUP** once again, or press the **RETURN** button.
- To browse the setup menu, use RC buttons **Up, Down, RETURN/Left, ENTER/Right**.

Quick Setting of Video Output Mode

The **MODE** button of the RC allows quick setting of video output mode without entering the setup menu. This type of video output configuration may be required in case after connecting your player to a TV/monitor/projector you see no picture on the screen.

After pressing the **MODE** button you will enter the quick video setting mode. In this mode, pressing one of the digit buttons **1, 2, 3, 4, 5** switches to one of the following video output modes respectively:

1. Composite/Component, **PAL**
2. Composite/Component, **NTSC**
3. HDMI, **480i**, 60 Hz
4. HDMI, **720p**, 60 Hz
5. HDMI, **1080i**, 60 Hz

To exit the quick video setting mode after successful settings, press **ENTER** on your RC.

- After pressing the **MODE** and a digit button please wait for up to 15 sec. before the new video mode is settled.
- The 5 listed video modes are provided only to ensure that you can quickly set up some usable video mode for any type of video connection you are using, regardless the previous settings of your player.
- After getting a picture on the screen with one of these modes, please go to Setup menu and choose the most appropriate video output and resolution.
- During a video playback, the **MODE** button is deactivated. To change parameters of video output, stop playback by pressing the **STOP** button.

In case of any problems, to make sure that the playback is stopped and you are in the file browser mode, switch the player off and then on, and wait until the player boots completely for up to 60 sec. Refer to the "Standby Mode" section.

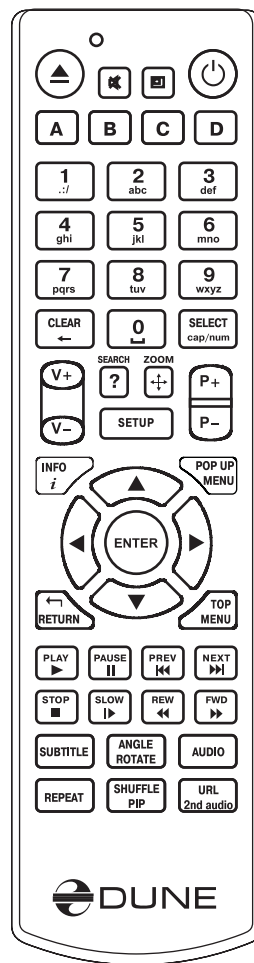

Setup Menu Sections

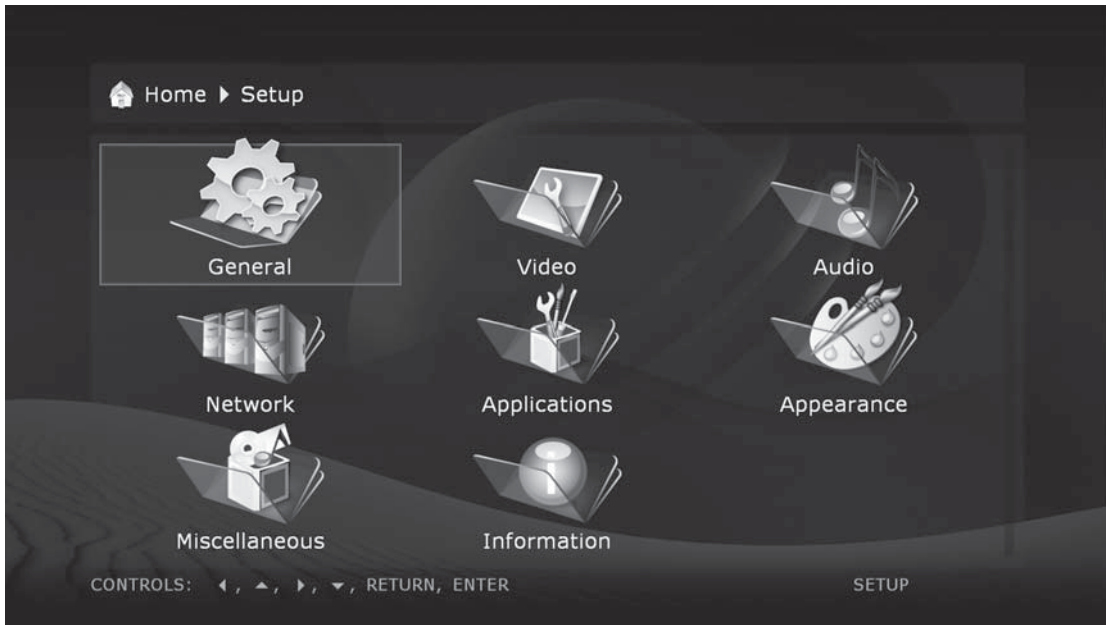

General

This section describes selection of general interface language and timeout for the screen saver activation.

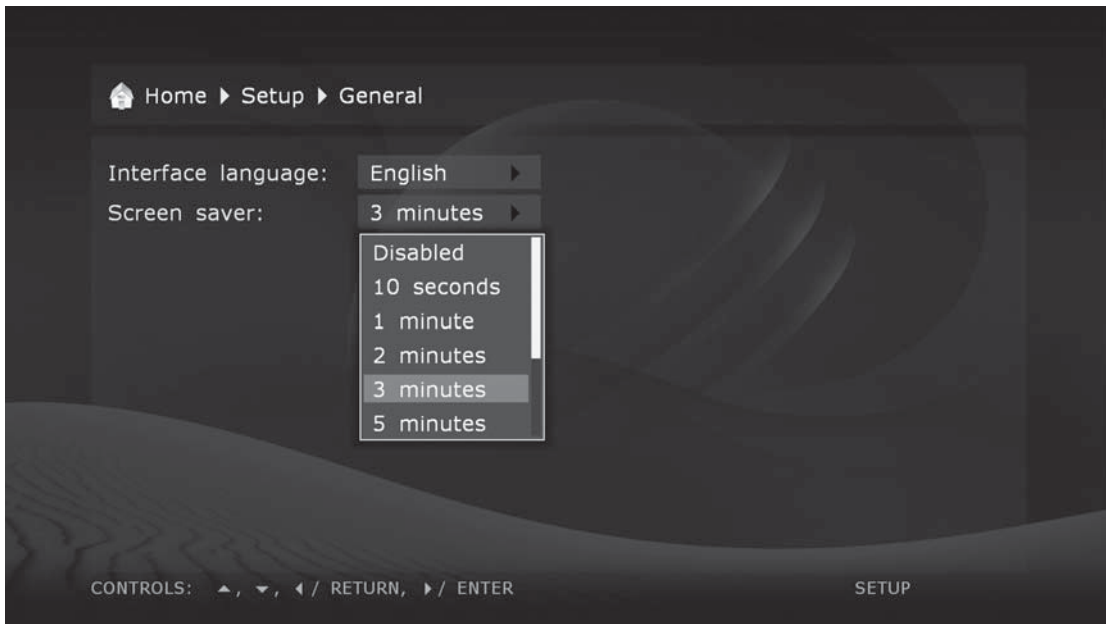

Video

In this section you will find settings of video output type (digital HDMI or analog) and adjusting of video resolution on selected output.

- The selected resolution will be used by default for all media files.
- Read carefully the manual for your TV/monitor/projector. Some video modes may not be supported by your equipment.
- In case of using the HDMI connection, depending on HDMI support in your TV/monitor/projector, intermediate HDMI equipment (if any) and the player, some video modes may not be available or may function improperly. In this case, use other video modes or other connection type.
- To have the best picture quality, it is recommended to use an HDMI connection. Refer to the "Connection to TV/Monitor/Projector via HDMI Input" section.

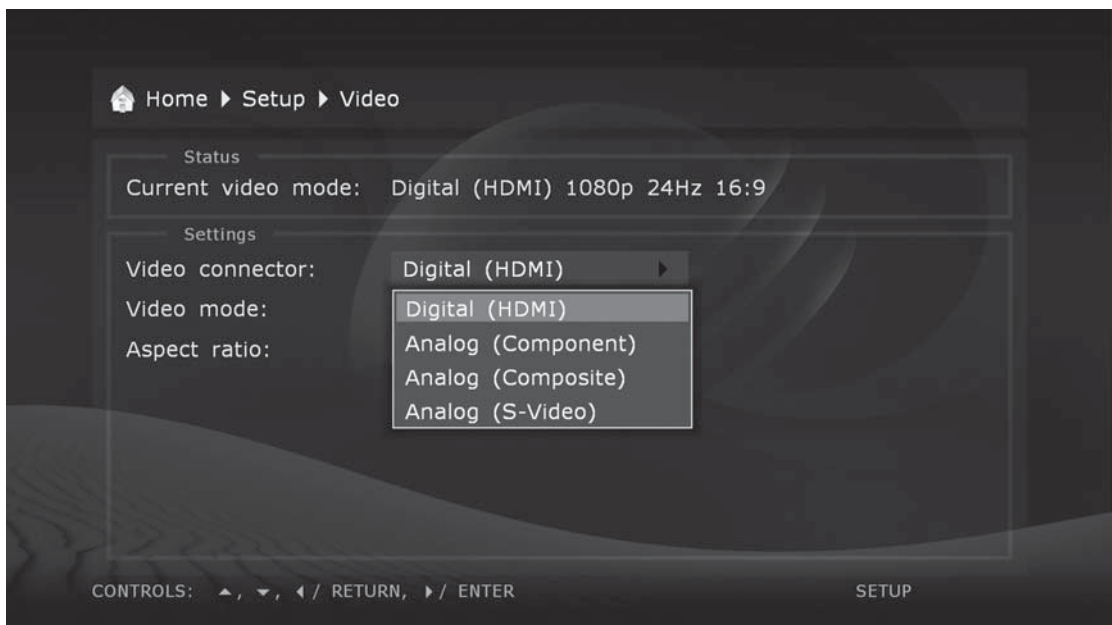
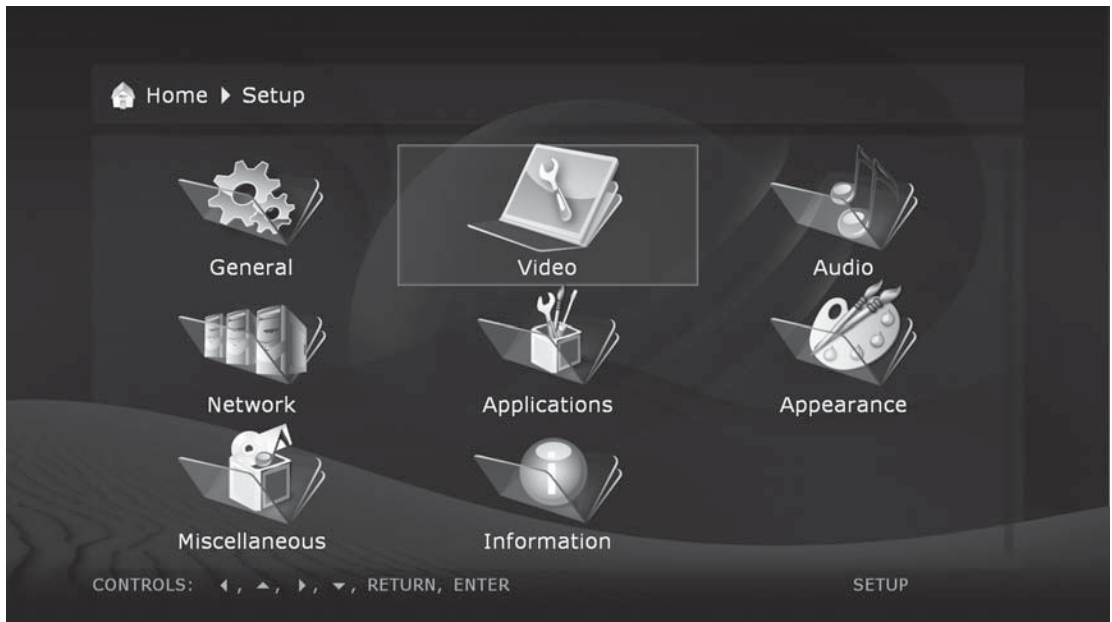

Audio

This section of the setup menu allows to set the connection type of relevant audio equipment.

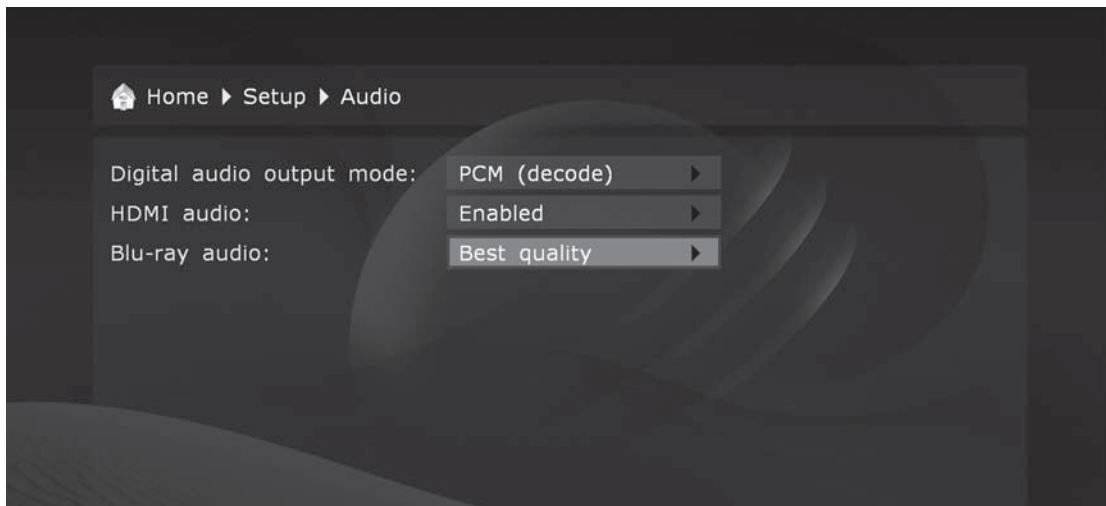
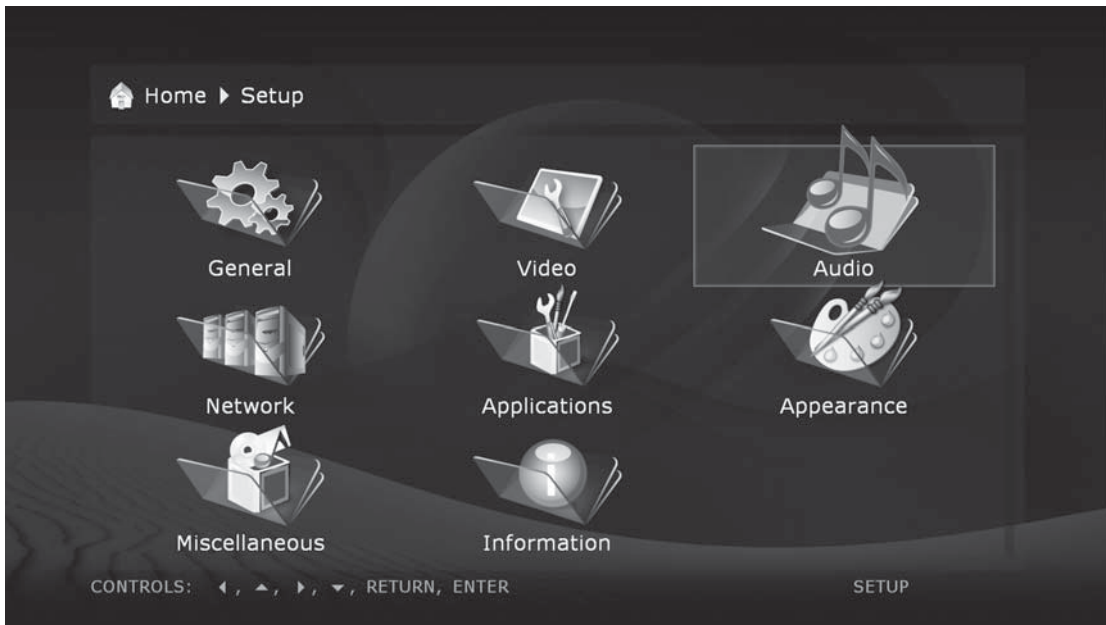

Digital audio output mode: you may switch the mode of digital optical output.

PCM (Pulse Code Modulation, forced decoding): a mode in which the original sound track, i.e. Dolby Digital or DTS, is converted (decoded) to the Pulse Code form. It is supported by decoders of virtually any up-to-date audio equipment. But this mode is only recommended in case your AV receiver does not support full decoding of multichannel sound of above formats, or the audio subsystem of a TV set connected via HDMI cable is used instead of a home theater system.

Original (Bitstream): a mode in which the original sound track, i.e. Dolby Digital or DTS, is transmitted to an external decoder in its original, encoded, form. Refer to the "Transmission of Digital Audio to AV Receiver" section.



HDMI audio: turn on and off transmission of audio signal via HDMI

Blu-ray audio

- When set to "Best quality", and the "Digital audio output mode" set to "Bitstream", the primary audio track is sent to both S/PDIF (digital audio output) and HDMI as a bitstream not depending on the presence of secondary audiotrack; secondary audio/video functions ("PiP") are disabled.
- When set to "PiP support", secondary audio/video functions are enabled, and, to support these functions, the player is allowed to use the "decode" mode instead of the "bitstream" mode on digital audio outputs (so the audio quality may suffer, e.g. stereo PCM may be sent to the S/PDIF output, and multichannel PCM may be sent to the HDMI output).

Network

This section describes main parameters of connecting the media player to a LAN or Internet.

Connection. You may select a type of connection which will be used by default. It may be Wired (twisted-pair cable connection) or Wireless (Wi-Fi connection; optional). Alternatively, the connection may be disabled at all.



Selection of networking mode:

Auto (DHCP): The media player is instructed to automatically receive an IP address and other parameters required for TCP/IP network.

Manually: All TCP/IP parameters are set by the user.

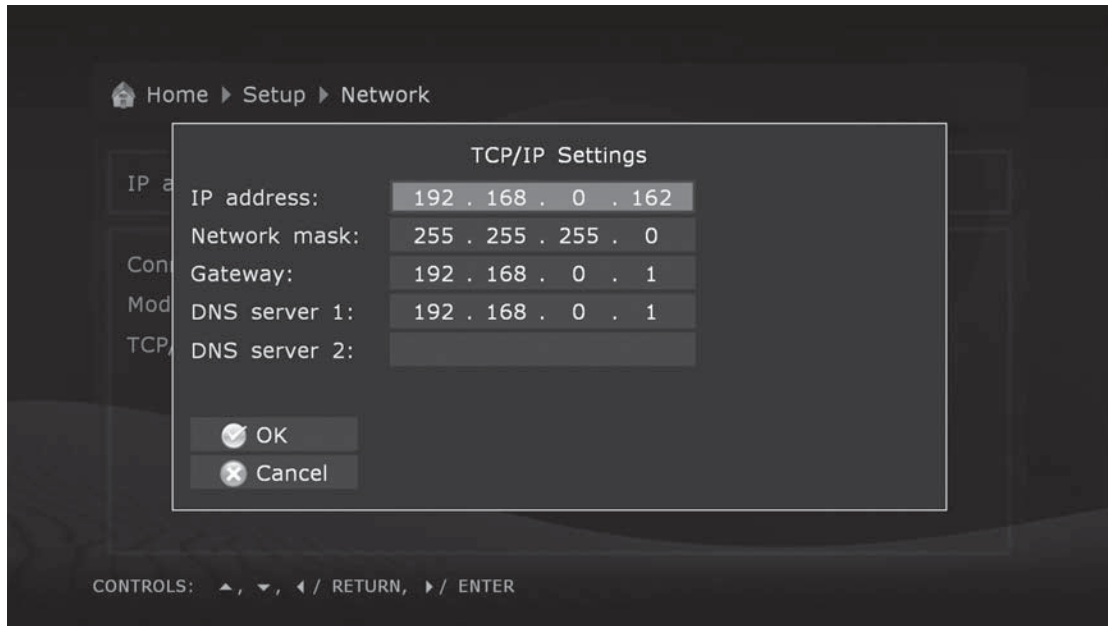

Information

This section provides system information about your device.

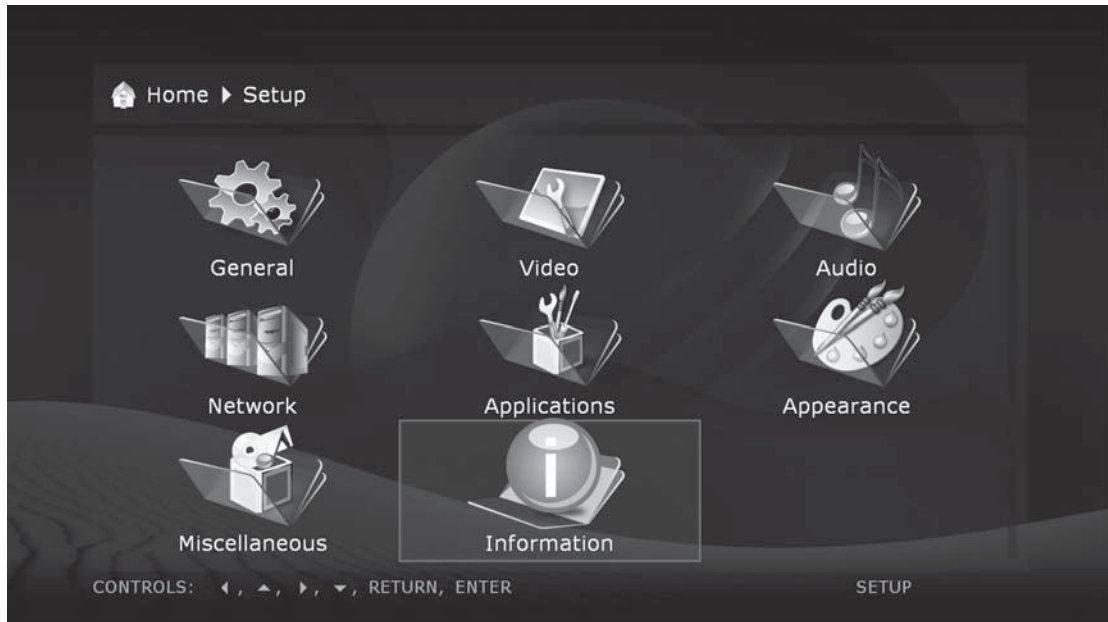

Miscellaneous

This section offers additional settings of your media player.



Menu Style

This section allows to select a visual style of the player menu.

You may use the menu style that is most suitable for you. It may be icons, or text messages.

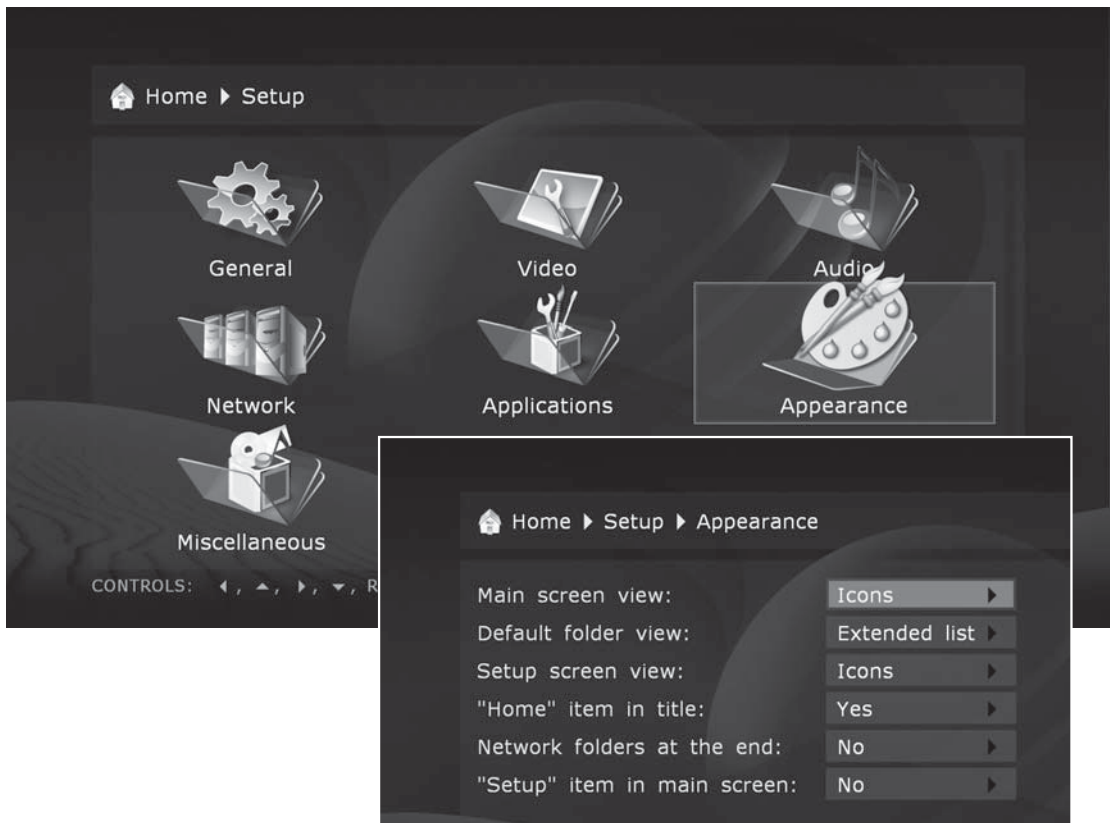

IPTV

This section describes media player setting for reception of IPTV channels.

In this Setup section, you may choose whether to show the IPTV feature on the main menu (the file browser root folder).

- For detailed instructions on using and setting up the IPTV, please refer to <http://dune-hd.com/support/iptv/>



Internet Radio

This section describes media player setting for reception of Internet radio stations.

In this Setup section, you may choose whether to show the IPTV feature on the main menu (the file browser root folder).

- For detailed instructions on using and setting up the IPTV, please refer to http://dune-hd.com/support/inet_radio/



Web Browser

This section describes media player setting for web browsing.

In this Setup section, you may choose whether to show the web browser item on the main menu (the file browser root folder).

- For detailed instructions on using and setting up the Web Browser, please refer to http://dune-hd.com/support/web_browser/

Torrents

This section describes media player setting for torrent downloading.

In this Setup section, you may configure the built-in torrent client.

- For detailed instructions on using and setting up the torrent client, please refer to http://dune-hd.com/support/torrent_client/

Encodings

This section allows to select text encoding for various player features.

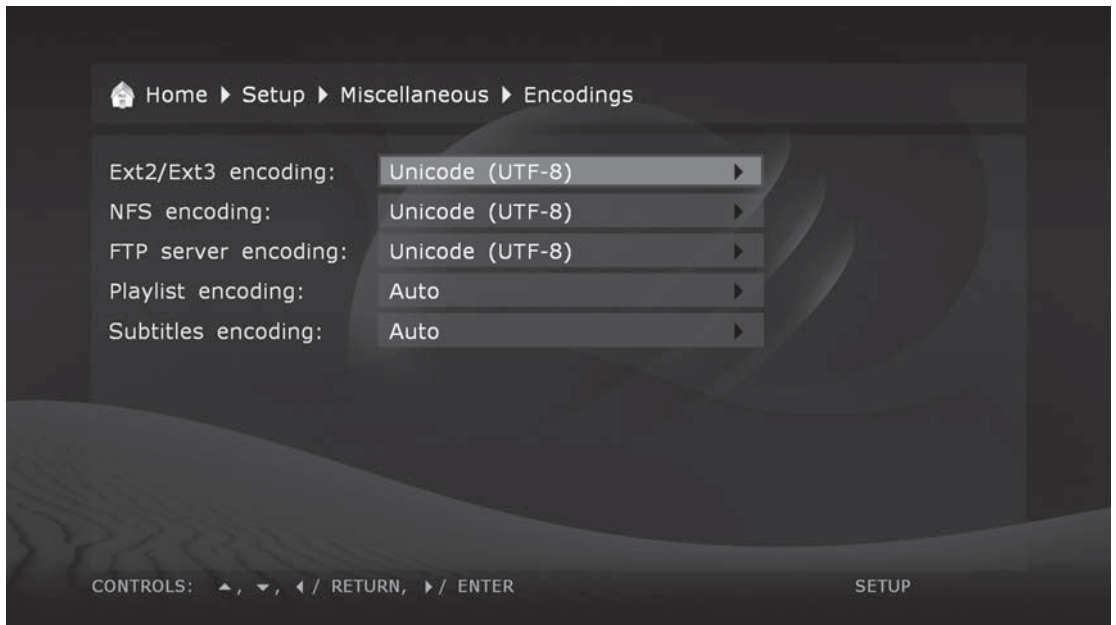



Playback

Chapter 5

File Browser

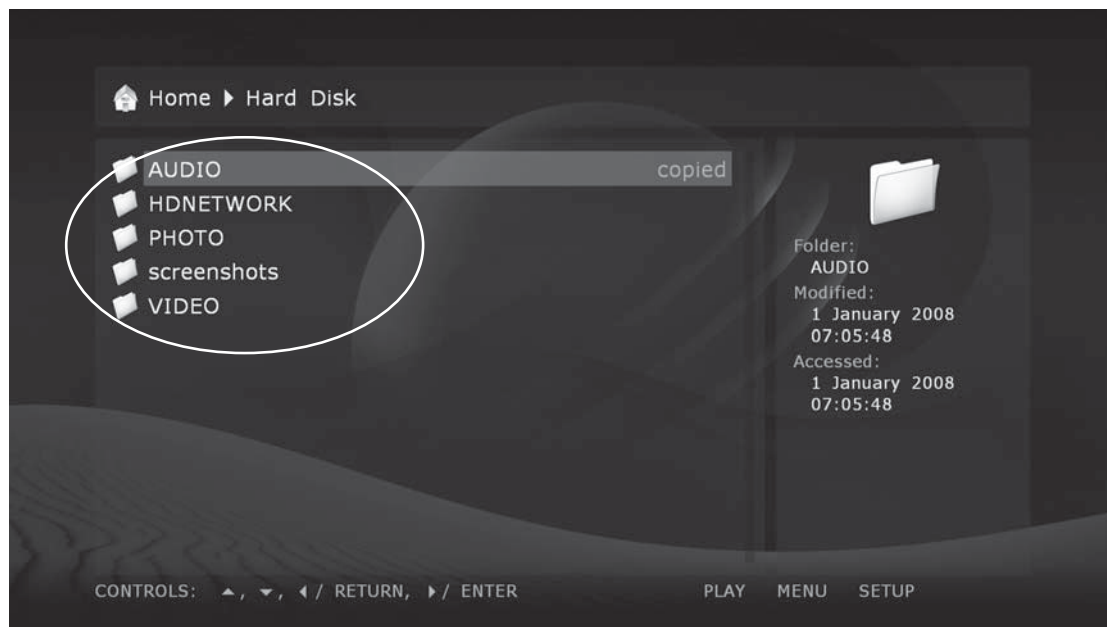

✓ The file browser allows browsing of all files and folders available. Browsing starts from the Main screen (also called the root folder), which includes subdivisions corresponding to connected drives and network resources.

Up: Select the previous file/folder from the list. Move the cursor to the area of the current path indication (in case the selection is on the first element of the list).

Down: Select the next file/folder from the list.

Left/Right: Depending on the chosen menu style, navigate the icon grid or perform the same function as the **ENTER/RETURN** buttons respectively.

P+: Select a file from the top of the page / move one page up.

P-: Select a file from the bottom of the page / move one page down.

RETURN: Return to the main (root) folder.

ENTER:

Enter the folder (when selected).

Start playback of the selected media file.

Show the selected picture.

Start playback of DVD-Video folder or Blu-ray folder.

Start firmware update (in case a firmware file is selected).

PLAY:

Start playing of all media files in the current folder (except for the files in subfolders) starting from the current file (you need to select a starting file using arrow buttons).

Start playback of DVD-Video folder or Blu-ray folder.

Start playback of all files in the selected folder, including files in subfolders, in alphabetical order.

Start playback of all marked files (in the same order as displayed).

MENU: Show context menu with a list of available additional commands for the selected file/folder and the current folder. Using the context menu allows you to execute the following commands:

- Display information on the selected file/folder (also allows to test file reading speed).
- Open a DVD-Video structure (browse disc contents instead of starting the playback).
- Mark or unmark the selected file/folder.
- Mark or unmark all files/folders in the current folder.
- Delete marked file(s)/folder(s).
- Copy marked file(s)/folder(s) (files/folders names are put to the clipboard).
- Cut marked file(s)/folder(s) (files/folders names are put to the clipboard).
- Paste previously copied/cut files/folders from the clipboard to the current folder (i.e. perform copying/moving of files/folders).
- Refresh the current folder contents.
- Create a folder.
- Create a network folder (only on Main screen).
- Change network folder definition.
- Delete network folder.

SELECT: Mark or unmark the selected file/folder, then move the selection to the next file/folder in the list.

CLEAR (<-): Delete the selected file/folder or marked files/folders (a confirmation is requested).

INFO: Display information on files/folders or the selected drive (also allows to test the file reading speed).

ANGLE/ROTATE: Refresh the contents of the current folder.

REPEAT: Return to the Main screen (the root folder) of the file browser.

SETUP: Switch to the Setup menu.

MODE: Switch to the quick setting of video output mode.

A (Red): (being pressed three times sequentially): Generate a debug dump in the current folder.

Marking Files and Folders

To execute operations with several files/folders at the same time, you may mark these files/folders. Use **SELECT** button on your RC or commands of the context menu.

- ✓ You may mark files/folders only within the current folder. In case of switching to another folder, the information on marks will be reset.

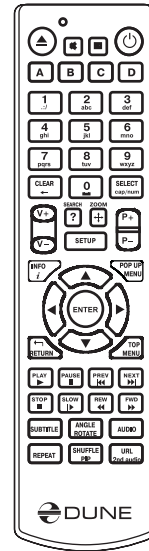
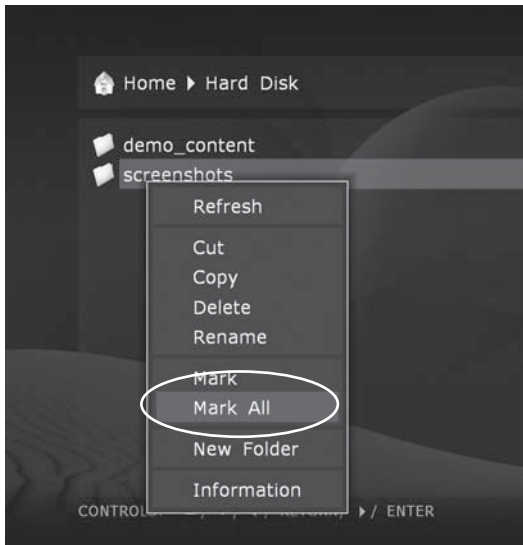

Copying and Moving Files and Folders

- Copying and moving files/folders is performed using the clipboard, much like it is done on a PC.
- To copy files/folders you need first to copy them to the clipboard, then go to the target folder and perform the Paste action.
- To move files/folders, you should first cut them to the clipboard, then go to the target folder and perform the Paste action.
- Cut, Copy and Paste actions may be executed using the context menu.
- In case of copying or moving a folder, its content will be copied/moved entirely, including all subfolders and their contents.

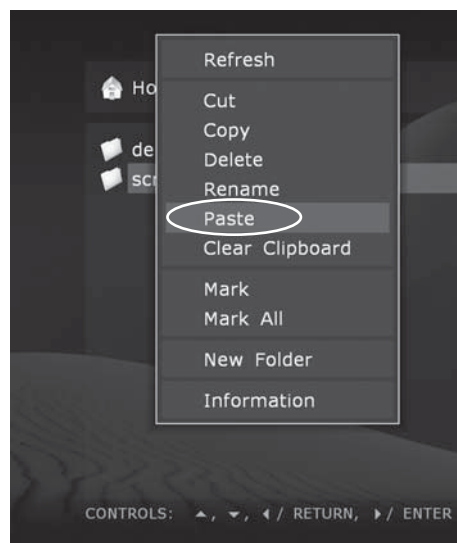
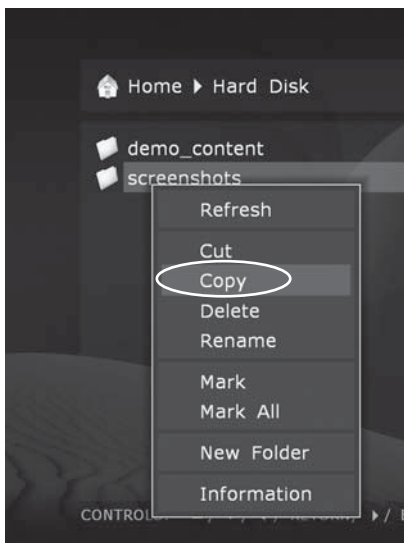

- To copy or move several files/folders at once, you should mark these files/folders.

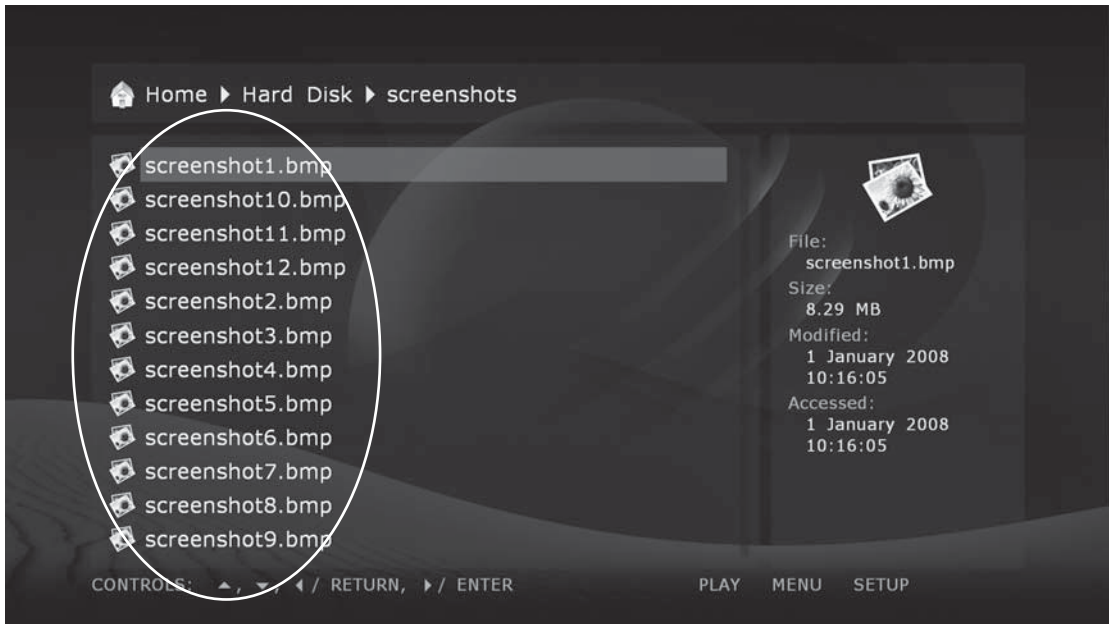

- ✓ In case of moving files/folders within a single partition of a drive, there is no physical copying of the data (only the directory information is updated on the drive), files/folders are moved to the new location instantly. In case of moving files/folders between different partitions or different drives, files/folders will be first copied to the new location, and then deleted from the old location. During copying you should not unplug the player or disconnect the drive. Otherwise the information loss may occur.

File Playback

The player supports playback of media files (video, music, photos) in various formats. You can play files from any drives attached to the player, or from network drives.

To play a media file, select the file in the file browser, and press **ENTER**.

To play all media files in the current folder starting with a certain file, select the file in the file browser, and press **PLAY**. The player will generate a playlist consisting of all media files in the current folder (not including files in subfolders), and will start playback of this playlist starting with the selected file.

To play all media files in a certain folder (including files in subfolders), select the folder, and press **PLAY**. The player will generate a playlist consisting of all media files in the folder (including files in all subfolders), and will start playback of this playlist.

To play a predefined playlist file (in M3U or PLS format), select the playlist file, and press **PLAY**. The player will load the playlist file, and will start playback of all items in the loaded playlist.

To play a given set of media files and/or folders and/or playlist files, mark all needed files and/or folders and/or playlist files using RC buttons **SELECT** and **MENU**, and press **PLAY**. The player will generate a playlist comprising all marked content (including all marked media files, all media files in the marked folders and all their subfolders, and all items from the marked playlist files), and will start playback of this playlist.

During playback of a playlist, you can easily navigate through the playlist using RC buttons **NEXT**, **PREV**, **MENU**.

When playing video or audio files, the player uses so called "file playback mode". Entering and leaving the file playback mode may take some time, and black screen may be shown.

When playing a list of photos, a special photo viewer application is used for nice photo showing with transition effects (see "Photo Viewer" section). When starting playback of a list of media files consisting of both photos and other kinds of media files (video, audio), the player will ask whether you want to show photos or play video and audio files.

In file playback mode, the following RC buttons are available:

STOP: Finish playback, return to the file browser.

PAUSE (| |): First press: switch to the pause mode.

- Subsequent presses: frame-by-frame display (switch to the next frame).
- To exit the pause mode, press **PLAY**.

Left/Right/Up/Down/P+/P-: First press: switch to playback position changing mode.

- Subsequent presses: change the playback position:
- **Left/Right:** Backward/forward by 10 sec.
- **Up/Down:** Backward/forward by 1 min.
- **P+/P-:** Backward/forward by 10 min.
- To exit the playback position changing mode, press the **ENTER** button (or wait until automatic switching to the selected position occurs after a short period of time).

0, 1, 2, 3, 4, 5, 6, 7, 8, 9: Switch playback position to **0%, 10%, 20%, 30%, 40%, 50%, 60%, 70%, 80%, 90%** (from the beginning of the file).

FWD (>>), REW (<<): Switch to the accelerated forward/backward playback, increase frame rate (switch between acceleration modes 1x, 2x, 4x, 8x, 16x, 32x).

- To return to the normal playback, press **PLAY**.

SLOW (|>): Switch to the slow-motion forward playback, decrease frame rate (switch between 1x, 1/2x, 1/4x, 1/8x, 1/16x, 1/32x).

- To return to normal playback, press **PLAY**.

INFO: Show/hide information on the current file:

File name. Container type. Format (codec type). Resolution of the video stream in the file. Maximum bitrate (statistics of the current session of file playback). Average bitrate (statistics of the current session of file playback). Current bitrate (playback statistics). Duration.

AUDIO: First press: display information on the current sound track.

- Subsequent presses: switch to the next sound track.

SUBTITLE: First press: display information on the current subtitles.

- Subsequent presses: switch to the next subtitles.
- **Up/Down:** Move subtitles up/down.

ZOOM: First press: switch to picture zooming mode, display information on current zoom setting.

- Subsequent presses: switch to subsequent picture zooming mode.
- In case the Special zooming mode is selected, the following RC buttons are enabled:
- **Left/Right:** Zoom in/out (proportional picture stretching).
- **Up/Down:** Increase/decrease vertical stretching (proportions adjusting).

- **P+/P-**: Increase/decrease the overscan area (useful to compensate for picture cropping by a TV/projector).
- To exit the picture zooming mode, press **ENTER** or wait until automatic exit will be performed after a short period of time.

SETUP: Display picture parameters setup menu (contrast, brightness, hue, saturation).

- **Up/Down:** Select previous/next parameter.
- **Left/Right:** Decrease/increase the current parameter value.
- **CLEAR:** Reset to the default value.
- To exit the picture parameter setting mode, press **ENTER** (or wait until automatic exit occurs after a short period of time).

MODE: Switch the deinterlacing mode used for playback of interlaced content. Modes available: motion adaptive (default), bob, constant blend, disabled.

A (Red): Switch to the sound synchronization adjustment mode, display information on current setting.

- **Left:** decrease adjustment value ("move" the sound backwards in time relatively to the video).
- **Right:** increase adjustment value ("move" the sound forward in time relatively to video).
- To exit the adjustment mode, press **ENTER** or wait until automatic exit occurs after a short period of time.

B (Green): First press: display information on the current status of video frame rate adjustment.

- Subsequent presses: turn on/off video frame rate adjustment. In case of activated adjustment, the video frame rate increases by a factor of 25/23.976.

PREV (|<<): Start playback of the current file from the beginning or switch to the previous file from the playlist (if the current playback position is close to the file beginning).

NEXT (>>|): Switch to the next file from the playlist.

MENU: Toggle showing of the browser of the current playlist.

- The browser displays the current playlist and the current item played.
- **Up/Down/P+/P-**: Navigate in the playlist.
- **ENTER:** Switch to the selected item in the playlist.
- **REPEAT:** Toggle the cyclic playback of the playlist.
- **SHUFFLE:** Toggle the random playback of the playlist.

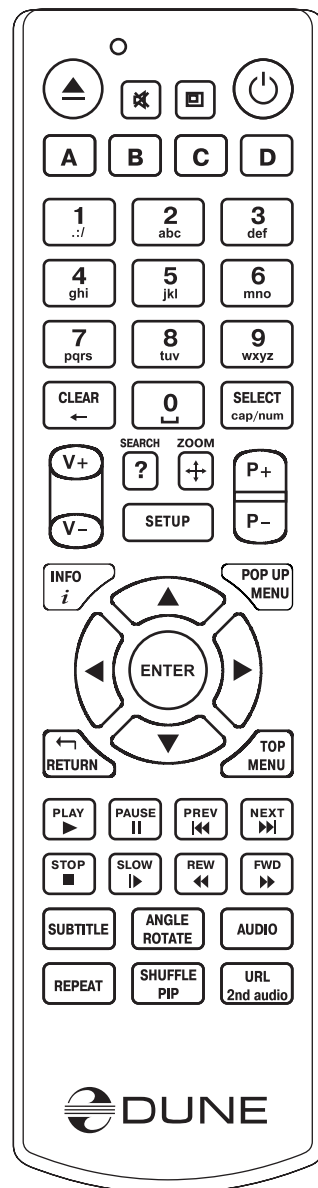

Blu-ray Playback

The player supports playback of Blu-ray discs (when a Blu-drive is connected to the player) and Blu-ray images (ISO files and BDMV folders). When you play a Blu-ray disc or image, the player uses so called "Blu-ray playback mode". In the Blu-ray playback mode, Blu-ray features such as Blu-ray menu, Blu-ray subtitles, BD-J, Bonus View, BD Live, are supported.

Note: when playing a Blu-ray disc or image, make sure that the System Storage USB flash drive is attached to the player and is recognized by the player (because it may be required for playback of the Blu-ray disc or image). Check Setup / System Information / System Storage to see whether the System Storage is attached. For more information on the System Storage, please see http://dune-hd.com/support/usb_flash_drive/.

Note: only Blu-ray discs without AAC protection are supported. Retail Blu-ray discs with AAC protection are not supported.

To play a Blu-ray disc, navigate to the Main screen of the file browser, and insert the disc into a Blu-ray drive attached to the player. The player will recognize the inserted Blu-ray disc and highlight the corresponding optical drive item on the Main screen. Select this optical drive item and press **ENTER** or **PLAY**. The player will start loading the Blu-ray disc.

To play a Blu-ray image, select the corresponding ISO file or Blu-ray folder (a folder containing "BDMV" subfolder), and press **ENTER** or **PLAY**. The player will start loading the Blu-ray image.

Depending on a particular Blu-ray disc or image, its loading may take some time (up to several minutes). While a Blu-ray disc or image is being loading, you may see a blank screen or "loading..." or a similar message on the screen. After the Blu-ray disc or image is loaded, the player will start playback of the disc (e.g. will show the disc menu).

In Blu-ray playback mode, the following RC buttons are available:

Left/Right/Up/Down/ENTER/RETURN: Navigate the disc menu.

POP UP MENU: Display an interactive menu of the disc (selection of scenes, switching between titles, additional materials, etc).

TOP MENU: Switch to the top menu of the disc.

A (Red), B (Green), C (Yellow), D (Blue): Perform functions specific to a particular Blu-ray disc.

STOP: Finish the playback, return to the Main screen of the file browser.

PAUSE: First press: switch to the pause mode.

- Subsequent presses: frame-by-frame playback (switching to the next frame).

- **PLAY:** Continue the playback.

SEARCH: Go directly to the desired time position.

PREV (|<<): Start playing back the current chapter from the beginning or switch to playback of the previous chapter.

NEXT (|>>): Move to playback of the next chapter on the disc.

FWD (>>), REW (<<): Switch to accelerated forward/backward playback mode, switching between acceleration modes: 1x, 2x, 4x, 16x.

- **PLAY:** Return to the normal playback.

SLOW (|>): Switch to the slow-motion playback. Switching between modes: 1x, 1/2x, 1/4x, 1/8x.

- **PLAY:** Return to the normal playback.

INFO: Show information on current status of the player:

- Current operation: PLAY, PAUSE, etc.
- Type of optical media used currently: BD-ROM, BD-R, etc.
- Type of sound track: Stream type DD, DD+, DTS, etc.
- Type of content and current playback time, e.g. "HDMV 00:25:53".
- Current disc title, e.g. "Title 1/11".
- Current disc chapter, e.g. "Chapter 8/27".
- Current bitrate, e.g. "Bitrate 34.43 Mbps".

AUDIO: First press: display information on current sound track.

- Subsequent presses: switch to the next sound track.

SUBTITLE: First press: display information on current subtitles.

- Subsequent presses: switch to subsequent subtitles.

ANGLE: Choose the viewing angle (if supported by the particular disc).

2nd audio: Turn the secondary audio track on/off, in case such track is present on a particular disc.

PIP: Toggles showing the picture-in-picture content, if such content is present on a particular disc.

ZOOM: First press: switch to the picture zooming mode, display information on current zoom settings.

- Subsequent presses: switch to subsequent zoom setting: 2X, 4X, 8X, 16X, ZOOM OFF.
- Left/Right/Up/Down: Navigation through the frame enlarged in **ZOOM** mode.

SETUP: Switch to the picture parameters setting mode (contrast, brightness, hue, saturation).

- Subsequent presses: select the next parameter.
- **Left/Right:** Adjust the selected parameter.

If after pressing an RC button, the INVALID KEY indication is displayed, it means that the procedure assigned to this button is currently disabled, or not supported for this disc.

DVD-Video Playback

The player supports playback of DVD-Video discs (when a DVD-drive is attached to the player) and DVD images (ISO files and VIDEO_TS folders). When you play a DVD-Video disc or image, the player uses so called "DVD playback mode". In the DVD playback mode, DVD features such as DVD menu and DVD subtitles are supported.

To play a DVD-Video disc, navigate to the Main screen of the file browser, and insert the disc into a DVD drive attached to the player. The player will recognize the inserted DVD disc and highlight the corresponding optical drive item on the Main screen. Select this optical drive item and press **ENTER** or **PLAY**. The player will start loading the DVD-Video disc.

To play a DVD-Video image, select the corresponding ISO file or DVD folder (a folder containing "VIDEO_TS" subfolder, or a folder containing "video_ts.ifo" file), and press **ENTER** or **PLAY**. The player will start loading the DVD-Video image.

Depending on a particular DVD-Video disc or image, its loading may take some time (up to several minutes). While a DVD-Video disc or image is being loading, a blank screen is shown.

After the DVD-Video disc or image is loaded, the player will start playback of the disc (e.g. will show the disc menu).

Note: when stopping the playback of a DVD-Video disc or image, the player remembers the current playback position and automatically restores it when the disc or image is loaded next time. To start playback of a DVD-Video disc or image from the very beginning (just as if it has never been played), press **CLEAR** two times after the disc is loaded.

In the DVD playback mode, the following RC buttons are available:

Left/Right/Up/Down/ENTER/RETURN (in DVD menu): Navigate the disc menu.

POP UP MENU: Display an interactive menu of the disc (selection of scenes, switching between titles, additional materials, etc).

TOP MENU: Switch to the top menu of the disc.

STOP: Finish the playback, return to the Main screen of the file browser.

PAUSE: First press: switch to the pause mode.

- Subsequent presses: frame-by-frame playback (switching to the next frame).
- **PLAY:** Continue the playback.

Left/Right/Up/Down/P+/P- (during playback): First press: switch to playback position changing mode.

- Subsequent presses: change the playback position:
- **Left/Right:** Backward/forward by 10 sec.
- **Up/Down:** Backward/forward by 1 min.
- **P+/P-:** Backward/forward by 10 min.
- To exit playback position changing mode, press **ENTER** (or wait until the automatic switching occurs after a short period of time).

0, 1, 2, 3, 4, 5, 6, 7, 8, 9: Switch to a DVD-Video chapter with the specified number. You may select a two-digit chapter number by entering both digits consecutively. If it's a one-digit number, please wait shortly after its input. All these operations should be performed during the playback. Also these buttons allow to select DVD-Video menu item.

PREV (|<<): Start playing back the current chapter from the beginning or switch to playback of the previous chapter.

NEXT (>>|): Move to playback of the next chapter on the disc.

INFO: Display/hide the information on played DVD: media (name of folder name; optical drive), type of media container, format (codec type), resolution of video stream in the file, maximum bitrate (statistics for the current file playback session), average bitrate (statistics for the current file playback session), current bitrate (playback statistics), duration.

AUDIO: First press: display information on current sound track.

- Subsequent presses: switch to the next sound track.

SUBTITLE: First press: display information on the current subtitles.

- Subsequent presses: switch between available subtitle versions.

ZOOM: First press: switch to the picture zooming mode, display the current zoom status.

- Subsequent presses: change zooming mode.

SETUP: Display picture parameters setup menu (contrast, brightness, hue, saturation).

- **Up/Down:** Select previous/next parameter.
- **Left/Right:** Decrease/increase the current parameter value.
- **CLEAR:** Reset to the default value.
- To exit the picture parameter setting mode, press **ENTER** (or wait until automatic exit occurs after a short period of time).

A (Red): Switch to the sound synchronization adjustment mode, display information on current setting.

SEARCH, then **PLAY:** Go directly to the main title.

CLEAR twice: Start playback the DVD-Video from the very beginning.

Audio CD Playback

The player supports playback of Audio CD (when an optical drive is attached to the player).

To play an Audio CD, navigate to the Main screen of the file browser, and insert the disc into an optical drive attached to the player. The player will recognize the inserted Audio CD and highlight the corresponding optical drive item on the Main screen. Select this optical drive item and press **ENTER** or **PLAY**. The player will start playback of the Audio CD.

When playing a Audio CD, the player treats each Audio CD track as a kind of an audio file, and performs playback of a playlist consisting of all Audio CD tracks, the same way as if the corresponding list of audio files was played in the file playback mode. The overall player behavior and available RC buttons are the same as in the file playback mode. See "File playback" section for more information.

Internet Radio Playback

The player supports playback of Internet Radio stations streamed using HTTP protocol in MP3 format.

For information on using Internet Radio, please refer to http://dune-hd.com/support/inet_radio/.

IPTV Playback and Recording

The player supports playback and recording of IPTV channels streamed using multicast UDP protocol (raw-UDP or RTP-over-UDP).

For information on using IPTV, please refer to <http://dune-hd.com/support/iptv/>.

HTTP Streams Playback

The player supports playback of network streams using HTTP protocol. This possibility is mostly intended for playback of Internet Radio (HTTP/MP3 streams, see "Internet Radio playback" section), but it can also be used for playback of other kinds of content streamed over HTTP protocol. Basically, all file formats supported by the player in file playback mode are supported (however, there may be specific limitations when playing content via HTTP).

To play a HTTP stream, prepare a playlist file (in M3U or PLS format) containing the corresponding HTTP URL, and just launch this playlist file in the player in the usual way. The player will start playback of the content streamed from this HTTP URL just like playback of any regular video/audio file in file playback mode. See "File playback" section for more information.

Photo Viewer

The player has a photo viewing function. Supported formats: JPG, PNG, BMP.

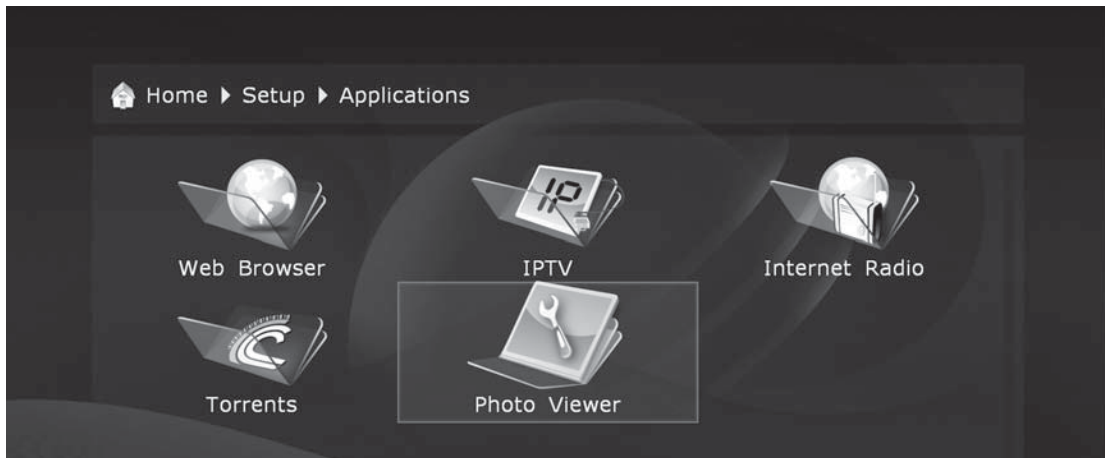

✓ In this "Setup" section it is possible to adjust the interval of picture switching (slide show) from 3 seconds to 1 day. Also it is possible to set the type of the picture transition effect.

If the "random" transition mode is selected, the effects will be used in a random order.

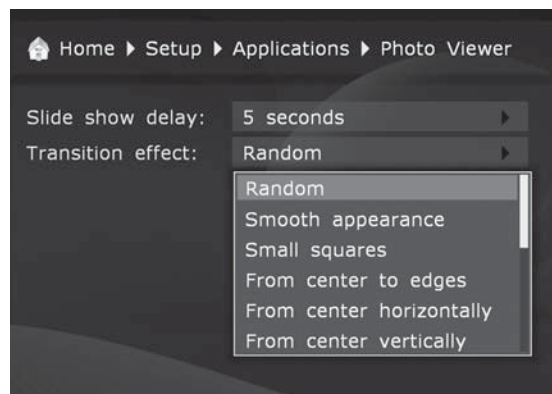
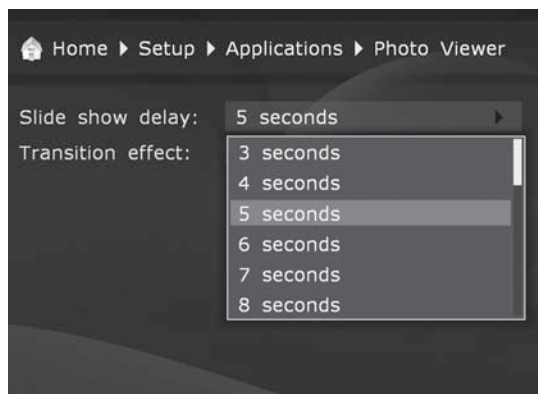

In the photo viewer mode, the following RC buttons are available:

RETURN, STOP: Stop the slide show, return to the file browser mode.

PAUSE: Pause the slide show.

- To resume the slide show, press **PLAY**.

PREV (|<<), Left: Show the previous file.

NEXT (>>|), Right: Show the next file.

POP UP MENU: Toggle showing of the browser of the current playlist.

REPEAT: Toggle the cyclic playback of the playlist.

SHUFFLE: Toggle the random playback of the playlist.

ROTATE: Rotate the picture clockwise.

1, 2, 3, 4, 5: Rotate/mirror the picture in different ways.

INFO: Show/hide information on the current file:

Format — file type. Width — picture width (pixels). Height — picture height (pixels). Bit Depth — number of colors.

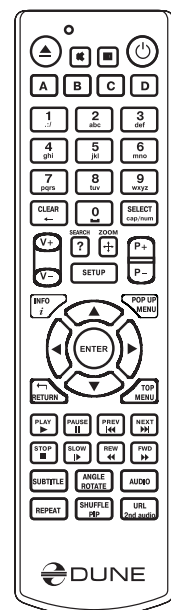



Accessing Network Drives

Chapter 6

The player allows to connect network drives via SMB and NFS protocols.

It is possible to connect any number of network drives. Each connected network drive is represented in the Main screen (root folder of the file browser) as a folder, called "network folder".



To create a new network folder (i.e. to register a new network drive):

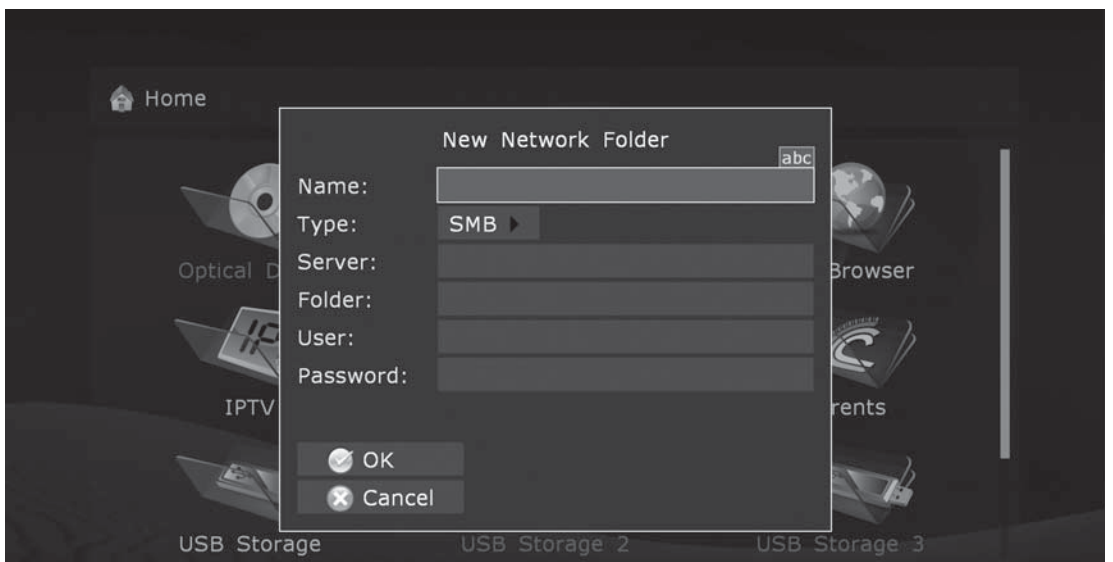

1. Enter the Main screen (root folder of the file browser).
2. ShowExecute the "New Network Folder" action in the context menu.

3. In the appearing window, assign network folder parameters.
4. Set the "name" field to any name which you like. This name will be shown as a folder name in the file browser.
5. Set the "type" field to SMB or NFS, depending on which protocol does your network drive support.
 - If you want to connect to a Windows PC and you are not familiar with the NFS protocol, the easiest way would be using SMB — in this case you won't need to install additional software on a PC; the built-in Windows software would be enough (for Windows 2000, XP and Vista).
 - If you want to connect to a NAS (Network-Attached Storage), and your NAS supports NFS, please use the NFS protocol.
 - Windows does not have a built-in software which implements the NFS protocol. If you want to use NFS for accessing files on a Windows PC, you should install and configure some NFS server, e.g. HaneWin NFS Server (refer to the manual on the developer's site).

Connecting via SMB Protocol

1. Set the "Server" field to the server IP address. E.g. "10.0.0.2".
 - When connecting to a Windows PC, the required IP address can be found in the network connection properties on a Windows PC.
 - Specifying the Windows computer name is not supported.
 - If your local network has DNS resolution, and the player has proper DNS parameters in its network configuration, you may use DNS-name of the server instead of an IP address.
2. Set the "Folder" field to the name of a shared folder (having proper access rights) on an SMB server. E.g. "VIDEO".
 - When connecting to a Windows PC, the name of the shared folder can be found in the properties of a folder on a Windows PC.
 - The name of a shared folder which is exposed to the network (so-called network name) may differ from its name on a hard drive; you should use the network name. If the SMB server requires user name and password, specify those values in respective fields (in most cases those are not required).

Connecting via NFS Protocol

1. Set the "Server" field to the IP address of an NFS server. E.g. "10.0.0.2". When connecting to a Windows PC, the required IP address can be found in the network connection properties on a Windows PC.
 - Specifying the Windows computer name is not supported.
 - If your local network has DNS resolution, and the player has proper DNS parameters in its network configuration, you may use DNS-name of the server instead of an IP address.
2. Set the "Folder" field to the full folder path on an NFS server. E.g. `"/data/video"`.
 - The folder path should begin with `"/"`. Path details are determined by the particular NFS server and its settings.
3. Press the "OK" button on the screen. The Main screen (the root folder of the file browser) will show the new network folder. Open this folder to browse the contents of the network drive.

- If an attempt to open a network folder fails with the "Cannot access network folder" message, please refer to the "Troubleshooting" section of this manual.

Accessing Player HDD from Network

You may use the player as a Network-Attached Storage (NAS), and access drives connected to the player from the LAN.

Note: For FTP access, it is enough to establish an FTP connection to the player. No user name and password is required (e.g. a so-called anonymous FTP access is used). If a particular FTP client requires specifying a user name and a password, enter the user name "ftp" and leave the password field blank.

Connecting to the Player via FTP from a Windows PC

1. Find out the IP address of the player (it may be done in the player Setup menu, System Information section).
 2. Open the Windows Explorer (i.e. use any opened folder window) and enter the following into the address bar: "ftp://player_ip_address" (e.g. "ftp://10.0.0.3").
- For FTP access, instead of the Windows Explorer it is recommended to use specialized FTP clients like FileZilla; such clients typically perform better.

Connecting to the Player via SMB from a Windows PC

For SMB access, the player offers a shared (with unrestricted access) folder with the name "internal_hard_disk", which corresponds to the internal HDD of the player. User name and password is not required.

1. Find out the IP address of the player (it may be done in the player Setup menu, System Information section).
 2. Open the Windows Explorer (i.e. use any opened folder window or press the Start button) and enter the following: "\\player_ip_address\internal_hard_disk" (e.g. "\\10.0.0.3\internal_hard_disk").
- You may alternatively connect to the player by typing "\\player_ip_address", "\\dune\internal_hard_disk", or "\\dune".
 - If you are unable to access the player from the network, please refer to the "Troubleshooting" section of this manual.



General

TROUBLE: The device does not switch on.

SOLUTION: Check if the media player is connected to AC mains.

TROUBLE: The device is properly connected to the mains, but works improperly.

SOLUTION:

It is possible that the temperature requirements were not observed, and there is condensate on internal parts. Immediately switch the device into Standby mode, and unplug it from the AC mains. Wait until the condensate evaporates, see "Safety Measures" section, and then start using the player normally.

It is possible that the device needs to be rebooted. Switch to Standby mode, and unplug it from the AC mains. Wait about 10 - 15 seconds, then turn it on.

Some features can work improperly or be disabled due to the particular media content. Make sure that expected features are present in the particular media fragment. If after all the remedies above you still think that the media player works improperly, please contact an authorized service center.

TROUBLE: The remote control does not work or works improperly.

SOLUTION: Please refer to the "Remote Control" section for proper operation of the remote control.

TROUBLE: The player turns on, but there is no picture.

SOLUTION: If during 60 sec after switching on there is still no picture on the screen, and the player power indicator is lighted, most probably the video output parameters of your player or video input of your TV/monitor/projector are incorrect. If you are sure that the equipment is properly connected (using appropriate cable connected to appropriate sockets), try to adjust video output settings using the MODE button of your RC. Refer to the Quick Setting of Video Output Mode.

TROUBLE: HDMI connection does not function or function improperly (picture disappears/jumps, etc.)

This kind of troubles results from bad compatibility of the player with some models of HDMI equipment. Symptoms may be the following:

HDMI connection is not available at all, although everything is properly connected and configured.

Periodical failure or jumping of picture during video playback or operation of the file browser.

Periodic warning on the TV/monitor/projector screen about video mode change during video playback or operation of the file browser.

Problems with sound on a TV set (during sound transmission through HDMI).

Color bars on screen.

Other artefacts.

Note: Reinitializing of HDMI video output of the player, which is performed when switching be-

tween the file browser and video playback (in the form of several second delay before playback start and return to the file browser) is an expected and normal player behavior with current firmware versions installed, it takes place with any HDMI equipment and does not prevent using the player. This feature is not related to the above problems.

SOLUTION:

First of all, make sure that the problem is related to the HDMI connection: try to use an analog connection to a TV/monitor/projector (e.g., component). If the problem persists after switching to an analog connection, it shall mean that it is not related to HDMI, but rather to your TV/monitor/projector.

- Try to switch on/off the sound transmission through HDMI (player Setup menu, Sound setting section), sometimes it has a considerable effect on the situation.
- Try different settings of video output: 480i/720p/1080i/1080p, 23.976/24/30/50/59.94/60 Hz. Your TV set may not support some video modes, or does it improperly. Change of video mode to another one compatible with your TV set may help solving the problem. You should test this by consecutive examination of video modes. It is suggested to start with the lowest picture resolutions.
- If possible, try to use another HDMI cable.
- If possible, try to change the mode of connection of the player to your HDMI equipment: e.g., instead of connection through a receiver, connect directly to a TV set.
- If possible, try to connect the player to another TV/monitor/projector or AV receiver, since the problem may be caused by another equipment, and not the player or HDMI cable.

If the problem persists, it is quite probable that the player is not compatible or is partially compatible with the particular HDMI equipment. It is probable that the future firmware releases will have modifications/updates eliminating problems with your HDMI equipment.

Video Playback

TROUBLE: Stuttering of the playback of high bitrate video files.

SOLUTION: For playback of high bitrate video files, please make sure that the player has sufficient (with some reserve) media data reading speed. The speed depends on the data storage drive. If the reading speed is insufficient, there will be playback failures. To avoid this kind of failures, it is advisable to store the file on a drive ensuring best read speed and playback the file from this device. Tip: the fastest drive is the internal hard drive of your media player.

You may test the reading speed of a specific drive as follows:

Select the file in the file browser, press the INFO button on RC and select "Read Test". The player will check the file reading speed and display the information on the maximum possible read speed for this file. For smooth playback of the file, this speed should exceed the maximum file bitrate with some reserve. In some cases, exceeding an average file bitrate with some reserve may be enough.

File bitrate may be evaluated during file playback by the player by pressing the INFO button.

Note: the information on bitrate delivered by the player is very rough and may be erroneous, that's why it is advisable to use this function only during a file playback from the drive which has a priori sufficient reading speed (e.g.: from internal EXT2/EXT3-formatted hard disk).

During file playback by the player, the information box activated with INFO button may display "Buffer underruns: ...", displaying the duration of time span in seconds during which underrun of the decoder input buffer took place. If you see this warning, it means the reading speed of the drive is insufficient.

During playback of a file from the internal EXT2/EXT3-formatted hard drive, the maximum possible data transmission speed is reached. It is suggested to copy a problematic file to the internal hard disk of the player. If during playback from the internal hard disk the problem disappears, it's most probably caused by the insufficient reading speed from the external resource used previously.

At the same time, jumps and other playback failures may result from properties of the media file. For instance, it may be encoded such a way that the player's decoder is not fully compatible with. You may check it easily: if file playback failures happen even when playing it from the internal hard disk, then the problem is caused by the file itself. It is probable that with the future firmware versions it may be played correctly, but the manufacturer cannot guarantee it.

TROUBLE: Selected file is not played back, although its format seems to be supported by the player.

SOLUTION: The problem may be due to several causes:

File error. To eliminate this factor you may try to play back the file with some software player installed on your PC. If all these players demonstrate the failure, then this file may be incorrect.

File encoding specifics. Although the player supports the majority of most popular file formats (containers and codecs), it does not mean that it will normally play back any file of these formats encoded in any way. Frequently, these files are made with violation of certain rules, and although they may be correctly played back with different software players on a PC, the Dune player may not do this (since the hardware decoder of the player and/or player software are not designed for playback of such "exotic" files).

Player software or hardware limitations or errors. These limitations or errors may be potentially eliminated in future firmware updates.

If you think that a file is not played back by the player (or is played back improperly) and wish to draw the attention of firmware developers, please see the Report a Problem subsection below. Provide as much details as possible about the problem, as well as about the file: size in bytes, type of container (e.g.: MKV, TS, AVI), type of video codec (e.g.: MPEG-2, H.264, VC-1, MPEG-4), type of audio codec for all sound tracks (e.g.: AC3, DTS), frame rate (e.g.: 23.976, 24.0, 25.0, 29.97, 30.0), bitrate (e.g.: 20 Mbit/s). If possible, provide the link for downloading this file. In case such link is available, the probability of finding the solution rises significantly. In case of audio-related problems please do not forget to specify the way of connection to the relevant audio equipment, specific model of your receiving audio equipment and settings of the player from the Audio Setup section.

Network

TROUBLE: After an attempt to enter the network folder there is a popup: "Cannot access network folder".

SOLUTION: Several reasons and solutions of this problem are possible.

Incorrect type of network folder.

- Correct it by specifying the correct path to the folder.
- If you connect to a Windows PC (2000, XP or Vista) and are not familiar with NFS, then specify SMB.

Incorrect IP address (or DNS-name) of the server.

- If you use a DNS-name, try to use the IP address of the server. Make sure that the IP address of the server is correct. You may find this information on a Windows PC, in network connection properties.

Incorrectly configured or disabled network connection between the player and the server.

- Make sure that the player and the server are properly connected to the network (check connection of network cables).
- Make sure that the player's network parameters are set correctly (Setup menu, "Network" section).
- Enter the player Setup menu, System Information section, and make sure that the IP address line displays correct IP address and that "connected" is shown to the right of the IP address.
- If you connect to a Windows PC, do the following: first, find the IP address of the player (see Setup menu, System Information section). Then, on the PC: press Start, Run and enter in the command line: "ping player_ip_address" (e.g.: "ping 10.0.0.3"). If successful transmission of packets is displayed, it means that the network connection between the player and the Windows PC is correct.

Incorrect name of network folder.

- Make sure that the correct name is entered. If you connect to a Windows PC, name of the shared folder may be found in the folder properties on the PC. Make sure that the server is correctly setup (required folder is open for access). Make sure that you may have an access to the shared folder from another PC or another network device.

Incorrect user name/password (in case of SMB connection).

- Make sure that you enter correct user name and password. Make sure that you may get access to a shared folder with the specified user name and the password from another PC or another network device.

TROUBLE: No access to internal hard disk of the player through the network.

SOLUTION: Several reasons and solutions of this problem are possible.

Incorrectly configured or disabled network connection between the player and the client PC.

- Make sure that the player and the client PC are correctly connected to the network (check the network cable connection).
- Make sure that the network parameters of the player are correct (see Setup menu, Network section).
- Enter the player Setup menu, System Information section, and make sure that the shown IP address is correct, and "connected" is shown to the right of the IP address.
- If you connect to a Windows PC, do the following: first, find the IP address of the player (see Setup menu, System Information section). Then, on the PC: press Start, Run and enter the command line "ping player_ip_address" (e.g.: "ping 10.0.0.3"). If successful transmission of packets is displayed, it means that the network connection between the player and the Windows PC is correct.

Incorrect IP address of the player.

- Make sure that you enter the IP address currently assigned to the player. You may find this IP address in the player Setup menu, System Information section.

Reporting a Problem

If you want to report your problem or a debug dump to the manufacturer, please visit <http://dune-hd.com/support/feedback/>.



Firmware Recovery Procedure

Chapter 8

In case of firmware upgrade crash (e.g. the player is switched off during firmware upgrade), firmware recovery is possible in most cases (except the case when the new firmware version has a modified "kernel" part and the upgrade crashes exactly when rewriting this "kernel" part (first 15% of upgrade progress)).

1. Copy a firmware DFF file into "dune_firmware.dff" file at the top level of a USB flash drive (preferably use exactly the same firmware version as was attempted to install during the failed upgrade).
2. Switch the player off (using the power button on the player).
3. Attach the USB flash drive with the "dune_firmware.dff" file to the player.
4. Switch the player on.

✓ The player should detect the USB flash drive and automatically start firmware recovery procedure. You should see "RECOVER", "CHK 0", "CHK 1"... "CHK 99", "REC 0", "REC 1"... "REC 99", "OK", "EJECT STORAGE AND REBOOT" messages on the front panel of the player.

✓ On an error, a message "ERR ..." is displayed on the front panel of the player. Here "..." is the error code. Possible error codes:

"ERR Ann", "ERR Bnn", "ERR Cnn": A problem with the "dune_firmware.dff":

- the file is invalid/broken
- the file corresponds to a wrong player model
- the file can not be read from the USB drive, etc.

✓ "ERR Dnn", "ERR Enn": A problem during data copying (e.g. the USB drive disconnected during data copying).

5. Detach the USB flash drive from the player, and delete the "dune_firmware.dff" file from it (do not attach the USB flash drive with this file to the player when you switch the player on, otherwise, the player will attempt to recover the firmware again).
6. Switch the player off (using the power button on the player).
7. Switch the player on.

The recovered firmware should load in the usual way.

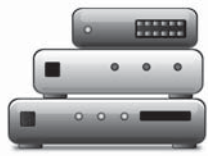

Player Specifications

Chapter 9

Video file formats	MKV, MPEG-TS, MPEG-PS, M2TS, VOB, AVI, MOV, MP4, QT, ASF, WMV, Blu-Ray-ISO, BDMV, DVD-ISO, VIDEO_TS
Audio file formats	MP3, MPA, M4A, WMA, FLAC, WAV, DTS-WAV, DTS, AC3, AAC
Picture file formats	JPEG, PNG, BMP
Video codecs	MPEG2, MPEG4, DivX, XVID, WMV9, VC1, H.264
Audio codecs	AC3 (Dolby Digital), DTS, MPEG, AAC, LPCM, WMA, WMAPro, EAC3 (Dolby Digital Plus), Dolby True HD, DTS HD High Resolution Audio, DTS HD Master Audio, FLAC
Subtitle formats	SRT, SUB, plain text/SSA/AAS (MKV), VobSub, PGS (Blu-ray playback only)
Playlist file formats	M3U, PLS
Processor	Sigma Designs 8634 SoC
System memory	RAM: 384 MB, Flash ROM: 32 MB
File systems	EXT2, EXT3, FAT32, NTFS (read-only)
Digital video output	HDMI 1.3
Analog video output	Component (Y/Pb/Pr), composite
Video modes	<ul style="list-style-type: none"> ● 480i, 480p (60 Hz) ● 576i, 576p (50 Hz) ● 720p (50 Hz, 60 Hz) ● 1080i (50 Hz, 60 Hz) ● 1080p (24 Hz, 25 Hz, 30 Hz, 50 Hz, 60 Hz) ● 1024x768, 1280x1024, 1280x768, 1280x960, 1360x768, 1366x768, 1400x1050, 1440x900, 1600x1200, 1680x1050, 1920x1200 (60 Hz)
Digital audio output	HDMI 1.3, S/PDIF optical (Toslink), S/PDIF coaxial
Analog audio output	7.1 analog audio outputs, stereo analog audio outputs
USB 2.0 host ports	2 x USB 2.0 host
eSATA host ports	1 x eSATA host
Network connectivity	Ethernet 100 Mbit/s Optional: Wi-Fi 802.11n (USB D-Link DWA-140, MiniPCI extension module) Optional: Ethernet 1000 Mbit/s (MiniPCI extension module)
Dimensions	430 mm (width) x 262 mm (depth) x 50 mm (height)

Notes

- Files with specific encoding or specific combinations of containers/codecs may not be played, or played with limitations or improperly. Firmware updating may resolve problems of playback for some files. This procedure may be carried out by the user or by a technician of post-sales service center.
- This manual corresponds to the firmware version 090626_1828. Check <http://dune-hd.com/manuals/> for updated versions of the manual. Check <http://dune-hd.com/firmware/> for updated versions of the firmware.
- The information in this manual is provided "as is", no guarantees of any kind are given in respect to its completeness or correctness.



Notes

Chapter 10



www.Dune-HD.com

