

10" TELEPORT

The Telescoping Telescope

Owners Manual



Copyright © 1997 by Sky & Telescope Magazine, Inc.

THE TELEPORT

is designed and hand-crafted by

Tom Noe

972-442-5456

tomnoe@wtd.net

4030 N. Hwy 78, Wylie, TX 75098

Owners Manual 2.1 © Teleport, 2001
Manual Design: Linda Silas, The Annex Studios
972-429-1636, www.annexstudios.com

TELEPORT 10''

The Telescoping Telescope

Owners Manual 2.1

PG **CONTENTS**

- 4 Overview**
- 5 Handling & Safety**
- 6 Unpacking**
- 7 Getting Started**
- 8 Opening**
- 10 Closing**
- 11 Collimation**
- 12 The Finder**
- 14 Eyepieces**
- 16 Observing**
- 18 Electrical**
- 20 Cleaning**
- 22 Service**
- 23 Specifications**

As you read through this manual, watch for the following symbols:

 **Caution!**

► *Tip*

Note: Observation

Enclosed with your telescope you will also find a user's manual for the Protostar Diagonal Mount Assembly used in the Teleport.

Overview



Fig1: The 10" Teleport closed

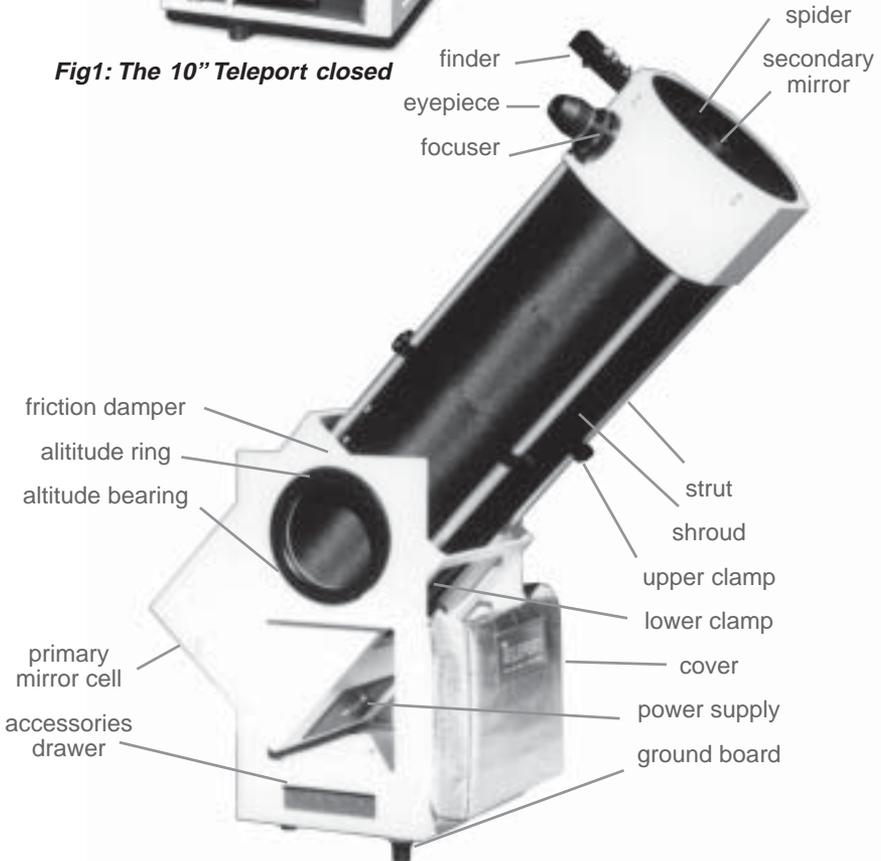

Fig 2: The 10" Teleport open

Handling & Safety

The Teleport is a precise, lightweight, very portable 10" reflecting telescope. It has a "Newtonian" optical system and an altazimuth or "Dobsonian" type mounting. Many aspects of it are more advanced than other telescopes of this type, and some special techniques are needed for proper operation. Be sure to read and follow the instructions in this manual to insure best results and avoid damage.

 **Never aim a telescope toward the sun!** This is extremely dangerous. A 10" mirror gathers about 1,000 times as much light as your eye, and **a split-second look can cause permanent blindness.** Never attempt to view the sun unless you understand the procedures and have fitted the Teleport aperture with a *proper solar filter*. Never place any telescope so sunlight can strike the mirror, now or as the earth turns. This can focus the sun's heat in the scope causing serious damage and possibly fire.

 **Watch your back!** The Teleport is lightweight for a 10" telescope. Still, it should be handled with appropriate care, especially if you have any physical limitations, such as a back problem. Use proper lifting techniques: lift with your legs, not your back, and avoid bending or twisting in an awkward way.

 **Handle with care!** The Teleport is a precision optical instrument. Always keep it upright unless following instructions in this manual requiring otherwise. When open the Teleport may be carried with one hand (Fig 3). For greater control, open or closed, it should be carried with both hands by the altitude rings (Fig 4). The strap on the top plate (Fig 5) is only for carrying the closed scope when walking. *Never swing the scope by this strap or pull sideways on it! This could pull the plate loose, causing the telescope to fall.*

When handling it in a manner that requires sideways movement, such as climbing steps or placing it onto a car seat, grasp the scope securely with both hands, one in each altitude ring. Openings in the cover are provided under the side tabs. Always lower it gently onto hard surfaces.



Fig 3: Carrying the open Teleport one-handed



Fig 4: Carrying the Teleport by the altitude bearings for control



Fig 5: Carrying the closed Teleport while walking

Unpacking

Unpacking your scope

1. With the box flaps open and the top foam pad removed, orient the box so the Teleport logo on the top of the cover is right-reading.
2. Slide a hand down each side about two inches and insert your fingers below the cover flaps and into the altitude rings (see Fig 4, page 5)
3. Grasp both rings firmly, lift the Teleport straight up out of the box and set it down gently.

Removing and Storing the Slip Cover

The Teleport cover is designed to protect your telescope from sun, airborne particulates and dew or brief, light rain. It is not intended to withstand prolonged or heavy rain. If such conditions occur, move your telescope to shelter.

1. Pull the flaps around the top loose from their velcro tabs and fold the top back.
2. Grasp the cover by the side openings and lift it off.
3. Fold the body of the cover flat (Fig 6),
4. Fold in half along the corner seams (Fig 7).
5. Fold horizontally (Fig 8) up into the lid
6. Pull the top flaps around the folded body and press the velcro tabs in place.
7. Align the folded cover on the lower front of the scope and press it onto the velcro strip provided.

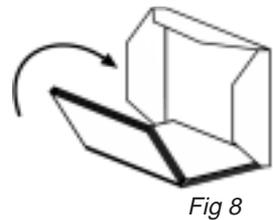
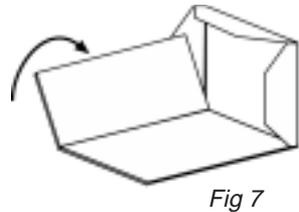
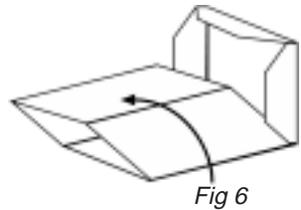

Replacing the Slip Cover

1. Pull the cover away from the velcro, unfold it and orient it over the scope.
2. With the lid up, slide it onto the scope until the straps rest on the top plate. Close the lid and press the velcro tabs in place on front and sides
2. The top may be lifted to access the handle for straight level carrying. The side tabs allow access to the altitude rings for more controlled movement such as in and out of a vehicle, through doorways, on stairs, etc.

Getting Started

Unlocking from “Shipping Mode”

The Teleport is simply closed for routine transport and opened again for use. When it was packed for shipping, the primary mirror was “locked” and must be “unlocked” before first use. This will take some time, but will also familiarize you with many details of your new scope.

You will need a philips screwdriver and 3/8” wrench.

1. Open the scope per the instructions on pages 8 & 9, then unlock the mirror as follows.
2. Turn each of the three white collimation knobs (see Fig 9) two full turns CCW.
3. Remove the mirror cell following steps 1-4 on page 20, then return to step 4 below.
4. Place the cell carefully on a table, mirror up. It will be covered by a solid plate with three tabs (Fig 10).
5. Remove the screws holding the tabs to the cell posts, and remove the plate.
6. Slide the cell so the top-post screw just overhangs the table edge for access.
7. Hold the top center post screw with a philips screwdriver and loosen its nut about a turn with the wrench (Fig 11).

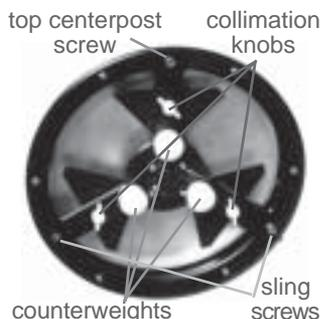

Fig 9: The mirror cell



Fig 11: The top post

8. Turn the screw CCW almost 1/2 turn so its small edge notch is at the top. Hold it there with the screwdriver while retightening the nut with the wrench. This orients the eccentric post so it no longer presses against the mirror.
9. Holding the cell vertical behind the mirror box, plug in the fan cord, then reinstall the cell and tighten all six screws.



Fig 10: Remove the mirror lock plate

Check Adjustment of the Mirror Sling

Aim the scope about 30° up from horizontal and push forward on each of the black triangles on the back of the mirror. The mirror should move forward easily, then return when you release it. If the mirror sticks at the top, the sling is too tight and is holding the mirror against the top center post. If it sticks at either bottom triangle, the sling is too loose, letting the mirror rest on the lower posts. To adjust, loosen the lower right cell post lock nut while holding the screw (Fig 12). Turn the screw back and forth enough to raise and lower the mirror. Hold it near the top of its travel range with the screwdriver while retightening the lock nut.



Fig 12: Adjust the sling

Opening

Opening the Teleport takes less than a minute, once you are familiar with the procedure. It's very easy, but improperly performing some steps can cause collimation error, reducing the image quality. It can also cause poor stability, and **even damage**. Practice the steps **exactly** to form good habits right from the start.

Remove the Top Plate

1. Orient the scope to read the caution label on the top plate.
2. Grasp inside the left altitude ring opening with your left hand, and the left end of the carrying strap with your right.
3. Keep the top plate *horizontal*, and pull your two hands apart *just enough* for the top plate to clear the slot in the left side of the rocker box(Fig 12) when you push it to the right.
4. Tilt the left side of the top plate up **just enough** to clear the top of the rocker box and move the plate to the left until it is out of the right slot (Fig 13).



Fig 12 - Yes



Fig 13 - Yes

 **Never tilt the left side of the top plate up more than an inch (Fig 14). The tremendous leverage you have on the slot could split the top edge of the rocker box!**

5. Place the top plate on the right side of the scope about an inch above the ground, align the velcro, and press it in place.



Fig 14 - NO!

Extend and Clamp the Struts

 **When opening or closing the Teleport, never release it completely unless at least one strut has *both* clamps locked, or it may fall and be damaged!**

1. Stand in front of the scope, facing the power supply.
2. Insert the fingertips of both hands into the top opening of the secondary cage and grasp it at about 3 and 9 o'clock (Fig 15).
3. Lift up smoothly and evenly with both hands, stretching the shroud and extending the scope to its full height.
4. Still holding the secondary cage up firmly with your right hand fingertips, move your left hand to grasp the left strut upper section and hold up on it.



Fig 15: Grasp the secondary cage

5. Continuing to lift firmly with your left hand, *almost* enough to lift the scope from the ground, tighten both left strut clamps with your right (Fig 16).
6. Grasp the right strut upper section firmly with your right hand, and again hold upward enough to *almost* lift the scope.
7. Continuing to lift firmly with your right hand, tighten both right strut clamps with your left.
8. Rotate the scope 180°, and repeat steps 4, 5, & 6, again holding up firmly on the top strut section so it is fully extended to its stop while you tighten the clamps.
9. Move the finder from its storage position to the secondary cage (see “Mounting” on page 12)
10. Open the eyepiece drawer, place an eyepiece fully into the focuser, and *close the drawer*.

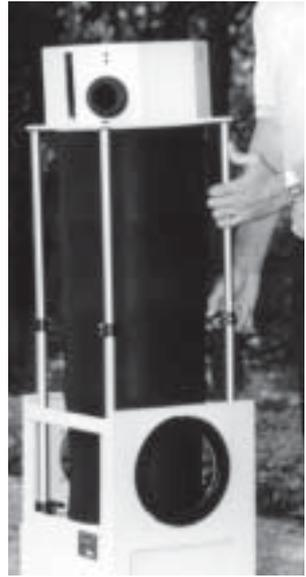

Fig 16: Tighten the clamps

The first time may take some doing, but with practice it will become and quick and easy.

Note: If you are opening the Teleport after unpacking it from its travel mode, return to page 7, step 2, to unlock the mirror before use.

Opening Tips

- *Proper tightness is achieved when the clamps are turned horizontal. If wear eventually makes adjustment necessary, consult the “Service” section on page 22 of this manual.*
- *If a strut hangs and prevents full extension, its middle section has rotated while the scope was closed (Fig 17). Rotate it to align the top clamp over the bottom one (Fig 18), then finish opening.*

To minimize this problem, when closing the scope loosen the clamps just enough to allow the struts to slide (about a half turn.) This should leave the clamps about horizontal, so they do not contact each other and cause rotation. A slight tension left in the clamps will also help prevent strut rotation during transport.

- *Holding the struts extended to their stops insures proper alignment of the secondary cage. Do this well and the collimation will usually be satisfactory for most observing. For more critical viewing, such as lunar and planetary observing, and to check your opening procedures, an additional collimation check is advised (see page 11.)*



Fig 17: Rotated



Fig 18: Aligned

Closing

Closing the Teleport is quite easy, but several small details will make a difference. As with the opening procedure, perform the steps in a precise and consistent way, practicing to make it easier and to minimize the potential for an accident.

Prepare and Lower the Secondary Cage

1. Aim the scope straight up, and turn it so the finder is facing you.
2. Remove the finder and clip it in the storage position.
3. Remove the eyepiece, place it in the drawer, and close the drawer.
4. Grasp the top section of the left strut with your left hand and loosen its upper and lower clamps each 1/2 turn with your right.
5. Reverse hands and repeat step 4 for the right strut.
6. Rotate the scope 180° and repeat 4-5 for the other two struts. *Be sure to support the secondary cage by holding up on the top section of a strut or on the secondary cage itself at all times.*
7. Grasp the secondary cage inside its top opening with both hands and lower it into the mirror box while keeping the scope pointed fully vertical (the mirror box should stay against the rocker box front plate.) A wiggle may sometimes be needed to help the struts retract fully.



Form the habit of always holding one of the upper strut sections. Never release the upper cage after loosening the clamps until you have lowered it gently into the mirror box!

Install the Top Plate

1. With the scope turned so the power supply faces you, grasp the top plate at the lower end of its strap and lift it out, bottom first, from the velcro on the side of the rocker box.
2. Hold it horizontal over the scope and rest its left edge on top of the rocker box left side.
3. Align and insert its right edge into the right side rocker box slot. Use the same caution here as when opening. *Never pull up on the plate while it is inserted into only one slot.*
4. Grasp the left altitude ring through its opening and pull it to the left while pulling the strap to the right just enough for the plate to clear the left rocker box side.
5. Lower the left side of the plate to align with the slot and release the rocker box side so it will close onto the plate.
6. Push the rocker box sides in to insure the plate is fully into both slots before lifting the scope by its strap.

Collimation

Any optical system must be properly collimated for best image quality. Collimation procedures can become a bit involved, as indicated by the many articles and books in telescope literature. The design and construction of the Teleport leaves only two variables that will normally need to be checked, namely the angles of both mirrors.

Laser Collimation

The fastest and easiest way to collimate your scope is with a Teleport Laser Collimator or other laser collimation tool. Briefly, this procedure is:

1. Insert the collimator into the focuser.
2. Adjust the secondary alignment screws so the laser spot falls inside the ring in the center of the primary mirror.
3. Adjust the primary collimation screws so the returning beam falls back onto the source in the center of the collimator face.

► *Details of this procedure are in the instructions for the Teleport Laser Collimator.*

Other Collimation Tools

Collimation can also be done with optical tools, including a *sight tube*, *Cheshire eyepiece*, and *autocollimator*. These are available from *Tectron Telescopes, 352-490-9101, <http://www.amateurastronomy.com>, tomclark@amateurastronomy.com*. Details of the procedures for these tools are in their manual and are also covered in the Protostar Diagonal Mount Assembly manual enclosed. Its diagrams show the visual appearance of the mirrors before and after collimation.

Collimation and Opening

Become comfortable with collimation of the Teleport to take full advantage of its high quality optics. Understanding the collimation procedures will help point out any problems you may have with proper opening techniques.

If you find after opening your scope, that the collimation is far off from the last time it was used, chances are you failed to get one or more struts fully extended either this time or the last. (Prior collimation may have partially compensated for this error, but performance will never be as good as if the scope is properly opened then collimated). If it appears way off, loosen all 8 clamps and partially close the Teleport and re-open it, being sure to reach full strut extension, before collimating.

► *The feedback provided by a quick check of collimation after opening your scope will help you perfect your opening technique. When you become proficient at this, you will find that your scope's collimation is very close every time. "Close" means that the laser spots on both the primary mirror and the collimator face are no more than a few millimeters from center.*

The Finder

The Teleport's Rigel Systems finder lets you easily place a particular object or sky area in the eyepiece field. It is easier to use than conventional finder scopes that have a more limited field or a reversed image, or both.

Mounting

1. With the Teleport open and vertical, stand behind it and locate the finder in its storage position in the lower rear opening of the rocker box.
2. At the left end of the finder, press the button with your thumb and rock the right end away from you to release it from the baseplate (Fig 19)
3. Locate the other baseplate at the top edge of the secondary cage. Hold the finder tilted 45° forward and slip the front (long) tab into the forward slot in the baseplate.
4. While pressing the thumb button, rotate the finder toward the plate and release the button so the clip locks into the slot at the rear of the baseplate.



Fig 19: Finder storage

On/Off and Brightness

Turn the finder on by rotating the small black knob on its lower front (Fig 20). It will click to turn on, and will increase in brightness as it is turned clockwise. At first, turn it fully clockwise and look through the opening near the top of the finder so you see the two red rings. Turn down the brightness to the lowest level that lets you see the two red rings (1/2 and 2 degrees) against the sky you have. (Setting the rings too bright can make it hard to see dim stars.)



Fig 20: Brightness control

Pulse

Adjust the small white knob (Fig 21), beside the black brightness knob, to control the duration of on- and off-time for pulsing, or set for continuous on as you prefer. (I find that on- and off-times of a few seconds let me see the faintest stars while it's off, and align accurately while it's on.)



Fig 21: Pulse control

Finding Objects

Look directly at the star or other object, or the area of the sky you want to aim at. Keeping both eyes open, move the Teleport so that the finder comes between one eye and where you want to aim. Position it so the object or area is centered in the circles.

Finder Alignment

1. With a long focal length eyepiece (about 40mm if possible) in place, follow the above procedure to aim the Teleport at a bright star. (Polaris is good, since it moves so slowly through the field.)
2. Look through the eyepiece. If the star is not in the field, sweep the scope in that area of the sky until it appears, and then center it.
3. Look through the finder with both eyes open and adjust the three white screws (Fig 22) to shift the red rings so the star is centered. Use care to avoid moving the scope when you do this.
4. Check the eyepiece field to see the star is still centered, and repeat as needed.
5. To improve the alignment accuracy, change to a medium power eyepiece (about 10mm) and repeat the procedure.



Fig 22: Finder alignment

Storage

Be sure to remove the finder from the secondary cage baseplate and place it on its storage baseplate before closing your scope.

Battery

The Rigel Finder uses a BR2032 or CR2032 three-volt lithium battery, or equivalent. These are readily available in the photo departments of department or electronics stores. To replace, remove the finder from its base, push out the battery and slip in the new one, being careful to get the polarity correct.

Eyepieces

The Teleport's 2" focuser and 1.25" adapter allow the use of many different eyepieces. Many types are available with a wide range of features, quality and price. Over the past several years I have evaluated many of the better types for use with the Teleport. As a group, I have found none as good overall as the Pentax XL series.

Pentax Eyepieces

Desirable attributes of the Pentax XL series include:

1. Ideal selection of focal lengths in logical steps throughout the range.
2. Full 20mm eye relief in all focal lengths
3. Wide 65° apparent field of view—which I find ideal (the 28mm is 55°)
4. High brightness, contrast, and sharpness.
5. Weights closely matched throughout the entire set.
6. Parfocal to a very close tolerance.
7. Very effective, adjustable rubber eye cups.

Tradeoffs are cost and slight edge astigmatism, which I find acceptable. The following table lists the focal lengths available, with their magnifications and fields with the Teleport:

Focal Length	Eye Relief	Apparent Field	Magnification	True Field
40.0 mm	20 mm	65°	32 x	2.04°
28.0 mm	20 mm	55°	45 x	1.22°
21.0 mm	20 mm	65°	60 x	1.08°
14.0 mm	20 mm	65°	91 x	0.72°
10.5 mm	20 mm	65°	121 x	0.54°
7.0 mm	20 mm	65°	181 x	0.36°
5.2 mm	20 mm	65°	244 x	0.27°

My usual set (Fig 23) includes the 40, 21, 10.5, and 5.2. For certain objects, however, the 14 and the 7 are ideal. Seeing conditions often preclude the use of the 5.2, so I sometimes substitute the 7. It can be used a bit more often, but doesn't provide quite the detail of the 5.2 when seeing is really good. The view through the 40mm is spectacular on extended objects. Its 2° field is almost half that of many finder scopes, making a finder scope unnecessary.



Fig 23: My Accessories Drawer

Holding the Eyepiece in Place

The clamping screw can be inserted in any of three threaded holes in the focuser. I don't normally use it, as the nylon friction screw in the focuser is more convenient. Set it to be just snug for your eyepieces.

Accommodating Other Eyepieces

Balance

Experienced observers may already have a preferred set of eyepieces. Most of these can be used with the Teleport, though some may impose problems. Wide variation in weight effects the balance, as with any small scope. The Teleport is supplied with three balancing weights that can be attached to the mirror cell on the bottom of the scope or to the secondary cage on the top. For heavier eyepieces, you may need to place one or more of the counterweights on the mirror cell. For very light ones, you may need to place one or more on the secondary cage.

If the scope is still unbalanced, you can increase the friction damping of the altitude bearings by adjusting the screws above of the altitude rings (Fig 24) with the allen wrench. Avoid excess tightening which would interfere with the smooth easy motion that is part of the joy of using the Teleport.



Fig 24: adjusting friction damping

Focal Plane Location

Most good eyepieces have a standard focal plane location, close to the surface that seats onto the focuser. Unfortunately, some designs may vary widely from this, requiring a large change in the focuser position. The Teleport focuser has, of necessity, a limited range of travel. Additional out-travel can be effected by sliding the eyepiece partway out and locking it with the screw.

If a 1.25" eyepiece you use frequently requires a lot of out-travel, consider using an adapter that extends it. Also, a recessed adapter may allow a 1.25" eyepiece to go farther in than the focuser top surface. Within limits, custom adapters are possible in order to parfocalize unmatched eyepieces. If you have a particular problem here, contact me for a quote.

It is also possible to adjust the location of the Teleport's focal plane in relation to the focuser. This is done by adjustment of the strut positions, effectively changing the length of the scope. You should do this only if you find it necessary for your overall set of eyepieces. It requires time and care, and is not practical as a routine adjustment. If you are certain you want to do this, see "Service" on page 22.

Observing

Every observer has favorite methods and objects. Many excellent books are available to help the beginner become familiar with the sky and learn the procedures for studying it. Here we present a few suggestions regarding the use of the Teleport, leaving the broad view of observing up to you and your chosen reference materials.

The Teleport is designed to give the observer a direct connection to the universe, imposing a minimum of technology between the user and the objects observed. Without digital readouts, “go-to” databases, etc., but with smooth, easy motions, using it quickly becomes very intuitive. It’s like looking directly at the object, but with a thousand times the light grasp of the unaided eye, and with the magnification best for the object to be viewed. Here are some tips:

Setup

Find a solid foundation

Always place the Teleport on a solid surface, such as the earth, gravel, concrete, etc. Be sure each of the three feet rests on the surface, and that the ground board between the feet does not. Tall grass will cause instability, and a surface such as a wood deck may flex when anyone moves on it, including when you shift your weight at the eyepiece.

Allow time for your mirror to reach thermal equilibrium.

While changing temperature, even a low-expansion Pyrex mirror changes shape. The image quality will be poor until it stabilizes. This can be a matter of a few minutes, but can be more under extreme changes. The thin mirror and open air flow of the Teleport minimize this, and the fan can reduce the equilibration time still more. Nothing can eliminate it completely.

Sky Conditions

Get to the darkest site you can.

Take advantage of the portability of the Teleport. Of course there will be times you may want to observe in areas of substantial light pollution. Artificial lights and the moon still allow reasonable viewing of bright objects like planets and the moon, but will greatly diminish your ability to see those dim “faint fuzzies.” Filters can help.

Learn to work with the sky conditions that exist.

What you view, and the magnification you can use effectively will generally be limited by the “seeing” at the time. Upper atmospheric cells of varying temperatures bend the light passing through them, causing the image to shimmer, or just blur without apparent movement. Lower magnification will be required when seeing is poor. Expect to use high powers, (above 120x) a limited percentage of the time, depending on your observing site, season, frontal passages, etc.

Viewing

Begin with lower power.

If you are not an experienced observer, use eyepieces in the 20-40 mm focal length range to make finding objects easier. The wider field is more likely to contain what you are looking for, and moving the scope while viewing is much less critical.

Learn “which way is up”.

Newtonian optical systems produce an inverted and reversed image, so when you move the scope, the image moves the opposite way. Think of it as pushing the object, not the scope, and you will quickly adjust to the reverse motions.

Learn to follow as the earth turns.

Objects will follow circular paths east to west. Remember that your scope will need to move in that same direction to keep them in view. Learn to move the scope along both axes as needed so that when you release it, the object will slowly drift through the center of the field as the earth rotates.

Areas of the Sky

Images of objects nearer the horizon will be adversely affected by the increased travel of the light through the atmosphere. Objects are best when viewed higher in the sky.

A special situation exists with the sky area directly overhead. This is often referred to by users of altazimuth telescopes as “Dobson’s Hole”. Movement of a telescope about its vertical (azimuth) axis is more difficult here than other parts of the sky because the lever arm used to turn it in azimuth is almost zero. Learn to twist, rather than push the scope in this part of the sky, and you will reduce the difficulty. A firm grasp in the opening of the secondary cage will help.

Recommended References

Nightwatch by Terrence Dickinson (Camden House; Camden East, Ontario; revised edition, 1993)

The Sky: A User’s Guide by David H. Levy (Cambridge; New York; 1991)

The Universe From Your Backyard by David J. Eicher (Cambridge; New York; 1988)

The Backyard Astronomer’s Guide by Terrence Dickinson & Alan Dyer (Camden House; Camden East, Ontario; 1991)

Electrical

Power Supply

Your Telexport is equipped with a power supply, fan, and secondary and eyepiece heaters. These enhance your observing under certain conditions by quicker temperature equilibration of the primary mirror and reduction of dew formation problems.

The power supply is in the front of the mirror box. It contains 6 “C” size alkaline batteries. These are readily available and offer maximum energy relative to weight and cost. They will run the mirror fan about 100 hours, the secondary heater about 40, and the eyepiece heater about 20. Keep these numbers in mind for an idea of when you may need to replace them. A spare set is recommended.

Sliding switches on the face of the power supply turn on the fan and secondary heat when slid toward the outside of the scope. Always slide them back toward center when not needed. Leaving either on when storing your scope will deplete the batteries. The external outlet in the front of the power supply is for a standard Kendrick eyepiece heater.

Changing Batteries

1. To remove the power supply, loosen the four philips screws at the corners (Fig 25).
2. Tilt the power supply and pull it out slightly to access the cords from the mirror fan and secondary heater, and unplug them.
3. The batteries are held securely in place by a cover that also stops reflections. Peel away the side of the cover opposite where the cables were plugged (Fig 26).
4. Remove the batteries and replace with fresh “C” size alkalines, in proper orientation as shown.
5. Replace the cover and seal its edge securely. The cover helps prevent the batteries from being dislodged during handling or transport.
6. Hold the supply close to the opening and plug in the cords.
7. Replace the supply and install the four screws.



Fig 25: Power Supply Cover



Fig 26: Removing Batteries

Mirror Fan

The mirror fan speeds up the cooling or warming of the primary mirror when the Teleport has been stored in warmer or colder conditions. While changing temperature, the mirror will distort, reducing image quality. If you wish to observe right away, switch the fan on when you set up the scope. If the temperature change is very small or you won't observe until much later, leave it off. The fan will actually increase the amount of mirror distortion at first, since it increases its rate of temperature change. The benefit is that it approaches final temperature and full image quality in less time. Turn the fan off once the mirror is stabilized, usually a quarter to a half hour but possibly longer with large changes in temperature. If a sudden change in temperature occurs while observing, the fan may be used again as needed.

Secondary Heat

Atmospheric conditions will often cause dew to form on surfaces at night, especially those able to radiate their heat toward the dark sky. If this seems imminent, switch the secondary heat on before dew begins to form. Once significant dew has formed on the secondary, considerable time may be needed to remove it. Under light dew conditions, operate the heater only part time to conserve the batteries. A red LED in the spider hub indicates when the heater is on.

Eyepiece Heater

Dew may also form on eyepieces or on the finder beam plate. A Kendrick eyepiece heater may be wrapped snugly around the eyepiece (Fig 27), moving it part time to the finder if needed. (The finder element may also be wiped gently with tissue if needed. It is not an expensive optical surface like the secondary mirror or eyepiece.)

The eyepiece heater is on when it is plugged in, so do not leave it plugged in when not needed (its power draw is much higher than the secondary heater or fan.) If dewing is heavy and you are using more than one eyepiece, it may help to keep those not in use in your pocket (31mm Naglers may not fit).



Fig 27: heating the eyepiece

Cleaning

Cleaning the Primary

Protect your mirror by keeping your telescope closed when not in use, so that cleaning will be needed very infrequently. Over time, you will see an accumulation of dirt, but it will have less effect on the image quality than you would expect. (Under some lighting conditions, such as with a flashlight aimed at the mirror in the dark, even a fairly clean mirror can look terrible.)

With proper care, cleaning should be needed only after extended use. When finally required, proceed as follows:

1. Open the Teleport, place an eyepiece in the focuser for balance, and tilt the scope almost horizontal.
2. Place a support under the secondary cage and tilt the scope until the cage rests on it. (When the mirror is removed, the scope will be unbalanced and could fall.)
3. With a philips screwdriver, remove the six screws holding the mirror cell (Fig 28). **Be sure to hold the cell securely while removing the last ones.**
4. Lift the cell away enough to reach into the mirror box, and unplug the fan cord.
5. Place the cell on a table and blow loose dust away with clean compressed air.
6. If the air cleaning proves sufficient, skip to step 19.
7. If washing is required, first slide the cell so the top post overhangs the edge of the table about an inch.
8. Loosen it's lock nut fully so the post is loose.
9. Peel the strap loose from the tape on the mirror edge, tilt the top post slightly, and lift the mirror out. (The three support triangles will remain attached to the back of the mirror)
10. Place it face up in a clean sink and run warm water to cover it.
11. Prepare a cleaning solution of three drops of mild hand dishwashing detergent in about a cup of warm water. Stir thoroughly to dissolve the detergent.
12. Pour most of the cleaning solution over the mirror surface.
13. Dip a cotton ball in the remaining cleaning solution and swab the mirror surface gently in a circular motion. Work from the center to the edge, being sure to not miss any of it.
14. Rinse thoroughly with running warm water, lifting and tilting the mirror to rinse the back, then finally the front surface again.
15. Pour a cup or so of distilled water over the surface then drain it off and stand the mirror on edge on a clean towel.

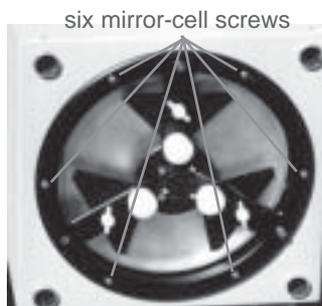

Fig 28: Mirror cell

16. If you have a source of clean dry air, blow the water off the mirror, including the rear triangles. If you don't have the air source, allow the mirror to stand until dry.
17. Replace the mirror in the cell in its original orientation (serial number at the top) and press the strap tape against the mirror edge.
18. Install the top post, orient it with the screw head mark to the outside, and tighten the nut.
19. Hold the cell near the rear of the mirror box and plug in the fan cord.
20. Align the posts with the holes in the mirror box opening and place the cell flat against the rear of the box with the screw holes aligned.
21. Install the six screws, leaving them slightly loose until all are started.
22. Tighten the six screws until snug.
23. Check the mirror sling adjustment per page 7.
24. Collimate per the instructions on page 11.

Cleaning the Secondary

(Refer also to the Protostar Manual included with your Teleport)

1. Loosen the secondary mount center nut a turn with a 9/16" wrench.
2. Hold the secondary mirror assembly with one hand and remove the nut with the other.
3. Slide the assembly down enough to allow access to the tiny heater wire connector between the mount and the spider hub and unplug it.
4. Remove the assembly completely from the scope.
5. Hold the assembly so the mirror surface is horizontal, facing up, and remove the two shroud screws.
6. Slide the shroud off, then lift the mirror away from its mount.
7. The back surface of the mirror will be coated with heat transfer compound. Scrape it off the mirror and return it to the center opening of the foam pad. ***Don't get it on the mirror surface.***
8. Wipe any remaining compound from the back of the mirror.
9. Clean and dry per the same procedure as the primary.
10. Place the clean, dry mirror onto the heat transfer compound on the pad.
11. Slide the shroud on so its rim is just snug on the mirror edge, as it was before removal. Insert and tighten the two shroud screws
12. Slide the mount stem through the spider hub and to plug in the heater connector. Rotate the assembly carefully to tuck the wire between the hub and mirror mount and align the three detents in the clutch plate with the three collimation screws.
13. Install the lock nut and tighten gently with the wrench, about 1/6 turn beyond finger tight.
14. Collimate the scope per the instructions on page 11.

Service

Instructions for some procedures follow. For other service questions, just send an email or give me a call!

Cleaning

Clean the optics only when really necessary, following the instructions in the prior section.

Wipe the laminated bearing surfaces and the remainder of the scope with a damp cloth, then a clean, dry one.

Nuts and Bolts

Periodically check all fasteners for proper tightness to insure stability and top performance. Do not overtighten screws, particularly those threaded into the Apple Ply structures.

Strut Clamp Adjustment

It is desirable that the strut clamp knobs are at a right angle to the strut when properly tight. With wear, this may change, and can easily be adjusted.

1. Note which direction and how far you wish the knob to be turned.
2. With the strut extended, loosen the knob about 5 turns.
3. Push the knob in against the spring so the hex head of the screw is out of its socket.
4. Rotate the knob and screw together one or more flats on the hex.
5. Tighten the knob and check. Repeat the above steps if needed.

Strut Length Adjustment

If you use eyepieces with a focal plane location far from the eyepiece seating surface, you may exceed the adjustment range of the focuser. That may be moved a few millimeters by shifting the strut locations. Do this only if really necessary, and do not be tempted to change it routinely. It must be carefully done, matching the location of all struts to keep the scope square.

A strut may be shifted slightly by loosening the 4 set screws holding the bottom section in the mirror box. The range of movement is very limited. Do not move the bottom of the strut section higher than the bottom surface of the mirror box. Do not extend it more than about 9mm below the bottom to avoid interference with the plate in the rocker box. Use a gauge to match the positions, and retighten all four screws.

Do not overtighten! This could bend the struts.

Specifications

Dimensions	14.5"w x 14"d x 26"h
Primary Structures	Apple Ply, 3-12mm
Finish	Polane T catalyzed polyurethane coating
Other Structures	Delrin acetal, ABS, Teflon, laminate, lycra spandex, etc.
Weight	32lb.
Primary Mirror	10" F/5 fine annealed Pryex, 10:1 Zambuto Optical serial# _____
Mirror Cell	9-point Delrin acetal
Secondary Mirror	Protostar 1.83" elliptical flat with enhanced Al coating
Focuser	Teleport 2" helical, 1.25" adapter
Finder	Rigel Systems unit-power LED
Cover	200D coated nylon and polyethylene
Batteries	Main Power Supply: 6 "C" size alkaline Finder: 1 BR2032 or CR2032 3V Li

TELEPORT

972-442-5456

tomnoe@wtd.net

4030 N. Hwy 78, Wylie, TX 75098