

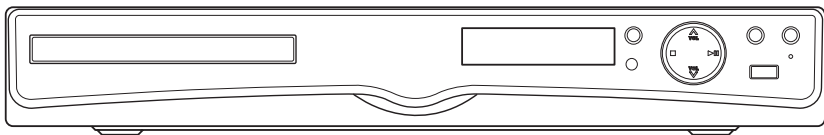

User manual

RTB1023



It's important to read this instruction prior to using your new product for the first time.

FCC Information

This device complies with part 15 of the FCC Rules. Operation is subject to the following two conditions: (1) This device may not cause harmful interference, and (2) this device must accept any interference received, including interference that may cause undesired operation.

This equipment has been tested and found to comply with the limits for a Class B digital device, pursuant to part 15 of the FCC Rules. These limits are designed to provide reasonable protection against harmful interference in a residential installation. This equipment generates, uses and can radiate radio frequency energy and, if not installed and used in accordance with the instructions, may cause harmful interference to radio communications.

However, there is no guarantee that interference will not occur in a particular installation. If this equipment does cause harmful interference to radio or television reception, which can be determined by turning the equipment off and on, the user is encouraged to try to correct the interference by one or more of the following measures:

- Reorient or relocate the receiving antenna.
- Increase the separation between the equipment and receiver.
- Connect the equipment into an outlet on a circuit different from that to which the receiver is connected.
- Consult the dealer or an experienced radio / TV technician for help.

WARNING: Changes or modifications to this unit not expressly approved by the party responsible for compliance could void the user's authority to operate the equipment.

Ventilation

You must adequately ventilate the product. Make sure there is adequate space around the unit to provide proper air flow for ventilation. See diagram.

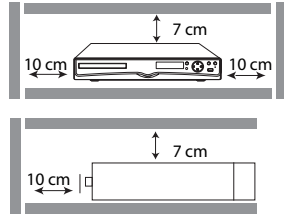

This product complies with DHHS Rules 21 CFR Subchapter J. Applicable at the date of manufacture.

For your Safety

The AC power plug is polarized (one blade is wider than the other) and only fits into AC power outlets one way. If the plug won't go into the outlet completely, turn the plug over and try to insert it the other way.

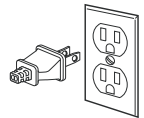

If it still won't fit, contact a qualified electrician to change the outlet, or use a different one. Do not attempt to bypass this safety feature.

Removing the power plug is the only way to completely remove power from your product. Make sure the power plug remains easily accessible.

Note

This unit has been designed to play back BD-video with region "A" and DVD-video with region "1". You cannot play back BD-video or DVD-video that are labeled for other regions. Look for the symbols on the right on your BD-video or DVD-video. If these region symbols do not appear on your BD-video or DVD-video, you cannot play back the disc in this unit. The letter or number inside the globe refers to region of the world. A BD-video or DVD-video labeled for a specific region can only be played back in the unit with the same region code.

Safety Precautions



CAUTION
RISK OF ELECTRIC SHOCK
DO NOT OPEN



WARNING SHOCK HAZARD-DO NOT OPEN
AVIS RISQUE DE CHOC ÉLECTRIQUE-NE PAS OUVRI
DO NOT EXPOSE THIS UNIT TO RAIN OR MOISTURE
NE PAS EXPOSER CET APPAREIL À DE LA PLUIE
OU DE L'HUMIDITÉ.

SEE MARKING ON BACK OF PRODUCT

WARNING: TO REDUCE THE RISK OF ELECTRIC SHOCK, DO NOT REMOVE COVER (OR BACK). NO USER SERVICEABLE PARTS INSIDE. REFER SERVICING TO QUALIFIED SERVICE PERSONNEL.

CAUTION: DANGER OF EXPLOSION IF BATTERY IS INCORRECTLY REPLACED. REPLACE ONLY WITH THE SAME OR EQUIVALENT TYPE.

WARNING: MAINS PLUG IS USED AS DISCONNECT DEVICE AND IT SHOULD REMAIN READILY OPERABLE DURING INTENDED USE. IN ORDER TO DISCONNECT THE APPARATUS FROM MAINS COMPLETELY, THE MAINS PLUG SHOULD BE DISCONNECTED FROM THE MAINS SOCKET OUTLET COMPLETELY.

Caution

This product utilizes a laser. Use of controls or adjustments or performance of procedures other than those specified may result in hazardous radiation exposure. Do not open covers and do not repair yourself. Refer servicing to qualified personnel.

Visible laser radiation when open. Avoid exposure to beam.

Class 1 laser product

This system must be opened only by qualified technicians to prevent accidents caused by the laser beam.

CLASS 1 LASER PRODUCT
APPAREIL À LASER DE CLASSE 1
PRODUCTO LASER DE CLASE 1

Please respect the environment and prevailing regulations.

Before you dispose of batteries or accumulators, ask your dealer whether they are subject to special recycling and if they will accept them for disposal.



THE LIGHTNING FLASH AND ARROWHEAD WITHIN THE TRIANGLE IS A WARNING SIGN ALERTING YOU OF "DANGEROUS VOLTAGE" INSIDE THE PRODUCT.

THE EXCLAMATION POINT WITHIN THE TRIANGLE IS A WARNING SIGN ALERTING YOU OF IMPORTANT INSTRUCTIONS ACCOMPANYING THE PRODUCT.

CAUTION: USE OF CONTROLS OR ADJUSTMENTS OR PERFORMANCE OF PROCEDURES OTHER THAN THOSE SPECIFIED MAY RESULT IN HAZARDOUS RADIATION EXPOSURE.

WARNING

To reduce the risk of fire or electric shock hazard, do not expose this product to rain or moisture. The apparatus shall not be exposed to dripping or splashing and that no objects filled with liquids, such as vases, should be placed on the apparatus.

This class B digital apparatus complies with Canadian ICES-003.

Cet appareil numérique de la classe B est conforme à la norme NMB-003 du Canada.



The symbol for Class II
(Double Insulation)



This product contains a low power laser device.

Service information

This product should be serviced only by those specially trained in appropriate servicing techniques.

Important Safety Instructions

Please Read and Save for Future Reference.

Some of the following information may not apply to your particular product; however, as with any electronic product, precautions should be observed during handling and use.

- Read these instructions.
- Keep these instructions.
- Heed all warnings.
- Follow all instructions.
- Do not use this apparatus near water.
- Clean only with a dry cloth.
- Do not block any ventilation openings. Install in accordance with the manufacturer's instructions.
- Do not install near any heat sources such as radiators, heat registers, stoves, or other apparatus (including amplifiers) that produce heat.
- Only use attachments / accessories specified by the manufacturer.
- Do not defeat the safety purpose of the polarized or grounding-type plug. A polarized plug has two blades with one wider than the other. A grounding type plug has two blades and a third grounding prong. The wide blade or the third prong is provided for your safety. If the provided plug does not fit into your wall outlet, consult an electrician for replacement of the obsolete outlet.
- Protect the power cord from being walked on or pinched particularly at plugs, convenience receptacles, and the point where they exit from the apparatus.
- Unplug this apparatus during lightning storms or when unused for long periods of time.
- Use only with a cart, stand, tripod, bracket, or table specified by the manufacturer, or sold with the apparatus. When a cart is used, use caution when moving the cart/apparatus combination to avoid injury from tip-over.
- Refer all servicing to qualified service personnel. Servicing is required when the apparatus has been damaged in any way, such as the power cord or plug is damaged, liquid has been spilled or objects have fallen into the apparatus, the apparatus has been exposed to rain or moisture, does not operate normally, or has been dropped.



Portable Cart
Warning

Important battery information

- Do not mix different types of batteries or new and old batteries. Do not mix alkaline, standard (carbon-zinc), or rechargeable (ni-cad, ni-mh, etc) batteries.
- In order to avoid any risk of explosion, observe the polarities indicated inside the battery compartment. Replace only with the type of batteries specified. Do not dispose of them in a fire or recharge them.
- If you are not using the remote control for a long period of time, remove the batteries.
- Do not dispose of batteries in a fire. Batteries may explode or leak.
- Batteries should always be disposed of with the environment in mind. Always dispose of batteries in accordance with applicable laws and regulations.

If your product operates on batteries, adhere to the following precautions:

- A. Any battery may leak electrolyte if mixed with a different battery type, if inserted incorrectly, or if all batteries are not replaced at the same time.
- B. Any battery may leak electrolyte or explode if disposed of in fire or an attempt is made to charge a battery not intended to be recharged.
- C. Discard leaky batteries immediately. Leaking batteries can cause skin burns or other personal injury. When discarding batteries, be sure to dispose of them in the proper manner, according to your state/provincial and local regulations.
- D. Battery shall not be exposed to excessive heat such as sunshine, fire or the like.

Important Information

Additional safety information

- Always leave sufficient space around the product for ventilation. Do not place product in or on a bed, rug, in a bookcase or cabinet that may prevent air flow through vent openings.
- Do not place lighted candles, cigarettes, cigars, etc. on the product.
- Connect power cord only to AC power source as marked on the product.
- Care should be taken so that objects do not fall into the product.
- Do not attempt to disassemble the cabinet. This product does not contain customer serviceable components.
- The mains plug of apparatus should not be obstructed OR should be easily accessed during intended use.
- Minimum 4 inches (10 cm) distances around the apparatus for sufficient ventilations.
- The ventilation should not be impeded by covering the ventilation openings with items such as newspaper, table-cloths, curtains, etc.
- No naked flame sources such as lighted candles should be placed on the apparatus.
- The use of apparatus in moderate climates.
- Do not open the cabinet. Lasers used in rays employed by the unit may damage your eyes. Any servicing should be done by qualified service personnel.

DVD copy protection

In accordance with the DVD standard, your DVD player is equipped with a Copy Protection system, which can be switched on and off by the DVD disc itself, in order to make any recording of the relevant DVD disc onto a videotape of very poor picture quality, or even impossible. This product incorporates copyright protection technology that is protected by method claims of certain U.S. patents and other intellectual property rights owned by Macrovision Corporation and other rights owners. Use of this copyright protection technology must be authorized by Macrovision Corporation, and is intended for home use only unless otherwise authorized by Macrovision Corporation. Reverse engineering or disassembly is prohibited.

Features

- Full high-definition video playback at up to 1080p resolution for an amazing viewing experience. Upconversion of standard definition DVDs for enhanced picture quality at up to 1080p over an HDMI connection.
- Rich multi-channel surround sound.
- Easy and simple HDTV connection using a single HDMI cable (cable not included).
- Multiple outputs for connecting your home theater system or amplifier.
- PIP functionality that lets you display primary and secondary video at the same time (if available on the Blu-ray Disc).
- Pop-up menu display without interrupting playback (if available on the Blu-ray Disc).
- HDMI 1080p/60fps output (Blu-ray Disc only) that provides smooth playback of video with a frame rate of 60 frames per second (TV must be connected with an HDMI cable and be compatible with 1080p 60 frame).

Compatible discs

- Blu-ray disc
- DVD-video (DVD-ROM)
- DVD+RW, DVD-RW
- DVD±R
- CD-DA (Audio CD), CD-R, CD-RW

Table of Contents

FCC Information	1	Watching movies with VUDU	18
Safety Precautions	2	Enjoying BD-Live	19
Important Safety Instructions	3	AUX	19
Important Information	4	The Settings Menu	20
Features	4	Language Setting	20
Table of contents	5	Display Setting	20
Connections and Setup	6	Audio Setting	21
Connecting to your TV	7	Speaker Setting	22
Connecting AUDIO IN from external sources such as a TV	8	System Setting.....	22
Connecting AUDIO OUT to an auxilliary Audio System	8	Network Setting	23
Connecting the speakers.....	9	Quick Setup	23
Positioning speakers	10	BD-Live Setting	23
Front speaker placement		Troubleshooting	24
Better surround placement	11	Additional Information	25
Test tone/Channel balance		Limited Warranty	29
Overview of Controls	11		
Front panel controls	11		
Remote control	12		
Quick Setup	14		
Playing a Blu-ray Disc or DVD	15		
Special Functions	16		
Searching for a title, chapter or elapsed time	16		
Repeating a title, chapter or CD track	16		
Using PiP (picture-in-picture) mode	16		
Using a disc pop up menu.....	16		
Selecting a play source	16		
Selecting the audio mode	16		
Selecting the camera angle	16		
Selecting subtitles	16		
Playing an audio CD	17		
Playing files on a data disc	17		
To play video files.....	17		
To view JPEG files	17		
Using a USB device	18		

Connections and Setup

What's included

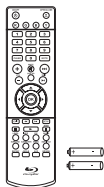

Remote control and
2 AAA batteries

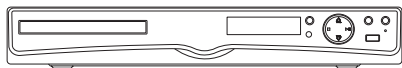

Main unit (receiver)

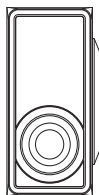

Subwoofer



Left and right front
speakers



Center speaker



Left and right
Surround speakers



Composite
Video Cable

Things to Consider before You Connect

- Ensure that the mains (AC power) supply in your house complies with that indicated on the identification sticker located on the back of your unit.
- Install your unit horizontally, away from any source of heat (fireplace) or appliances creating strong magnetic or electric fields. The components of this unit are sensitive to heat. The maximum ambient temperature should not exceed 35°C / 95°F.
- Leave enough space around the unit to allow adequate ventilation: 10 cm/4 inches on either side and above the top, and 5 cm/2 inches at the rear.
- The humidity of the room should not exceed 75%. If you have to use the unit outdoors, do not expose it to rain or splashing water. The apparatus should not be exposed to dripping or splashing and no objects filled with liquids, such as vases, should be placed on the apparatus.
- Moving the unit from a cold place to a warm one can cause condensation on some components inside the unit. Let the condensation disappear on its own before turning the unit on again.
- Before moving the unit, make sure the disc tray is empty.
- Where the mains plug or an appliance coupler is used as a disconnect device, the disconnect device shall remain readily operable.
- Other important use and cleaning information at the end of the booklet.

Connections and Setup

Connecting to your TV

Method 1 (best)

HDMI

- Connect the HDMI OUT jack on the rear of the unit to the HDMI IN jack on your TV using a HDMI cable (not included).
- You can select the resolution of the player's HDMI output signals (HDMI Auto, 1080p, 1080i, 720p, 480p and 480i) to match your TV's resolution capabilities, please see instructions on page 20 for details.

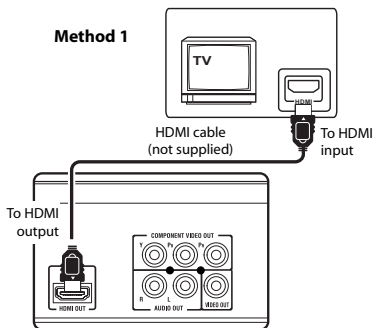

Notes

- Refer to the owner's manual of the connected TV as well.
- HDMI, the HDMI logo and High-Definition Multimedia Interface are trademarks or registered trademarks of HDMI licensing LLC.
- If your television is a high definition television with an HDMI input, we highly recommend you use the unit's HDMI output to get the highest possible video resolution.

Method 2 (good)

Component video jacks (Pr, Pb, Y)

- The component video jacks are color-coded green, blue and red.
- Additional component video cables (not supplied) are required. They are usually color-coded green, blue and red.
- Connect the component video OUT jacks on the unit to the component video IN jacks on your TV.

Method 3 (basic)

Composite video jack (yellow)

- This video jack is color-coded yellow.
- Use the video cable with yellow plugs (supplied) for good picture quality.
- Connect the video OUT jack on the unit to the IN jack on your TV.

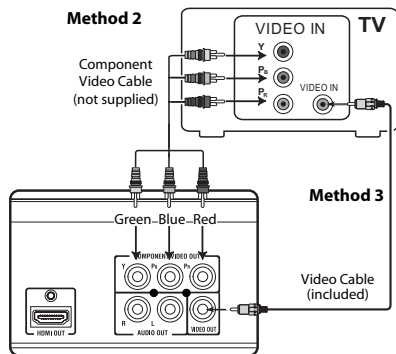

Notes

- If one of the devices is not working, check that all the cables have been inserted properly into the jacks.
- If your component has only one input for audio (mono), connect it to the left (white L/Mono) audio jack on the TV and don't connect the right audio part of the cable.

Connections and Setup

Connecting AUDIO IN from External Sources such as TV

Using AUDIO IN Jacks

Connect the AUDIO IN jacks from the unit to the AUDIO OUT jacks on TV, SAT/Cable Box, VCR or other component. Press either **SOURCE** button on the main unit or **AUX** button on the remote control to select **AUX** mode.

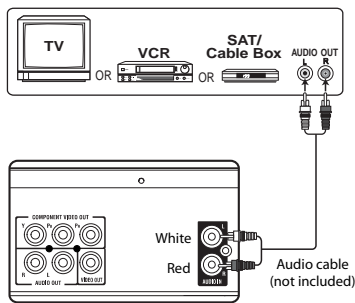

Connecting AUDIO OUT to an auxiliary Audio System (optional connection)

This system has AUDIO OUT jacks allowing you to connect to auxiliary audio systems such as a second audio amplifier or perhaps a wireless audio transmitter.

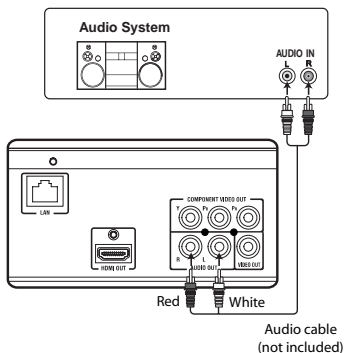

Connecting your player to a wired network router (optional)

Connect an Ethernet cable (CAT5 or better with RJ45 connector) to the ETHERNET jack on the back of your player and to an Ethernet jack on a network hub or broadband router.

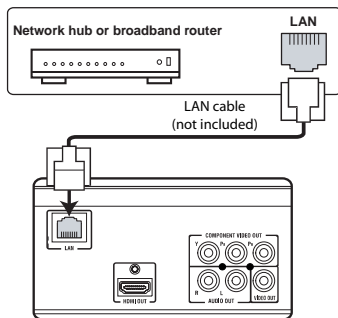

Notes

- Do not connect a modular phone cable to the ETHERNET jack.
- When plugging or unplugging the cable, hold the connector on the end of the cable. When unplugging, do not pull on the cable. Press down the lock tab and pull the connector out of the jack.
- Because there are various connection configurations, follow the instructions from your Internet service provider.

Connections and Setup

Connecting the Speakers

Speaker wires are color-coded to match the terminals. Connect the speaker wire from the back of each speaker to the corresponding color terminal at the back of the unit. Press down the tab to open the terminal and insert the wire. Release the tab to lock wire in the terminal.

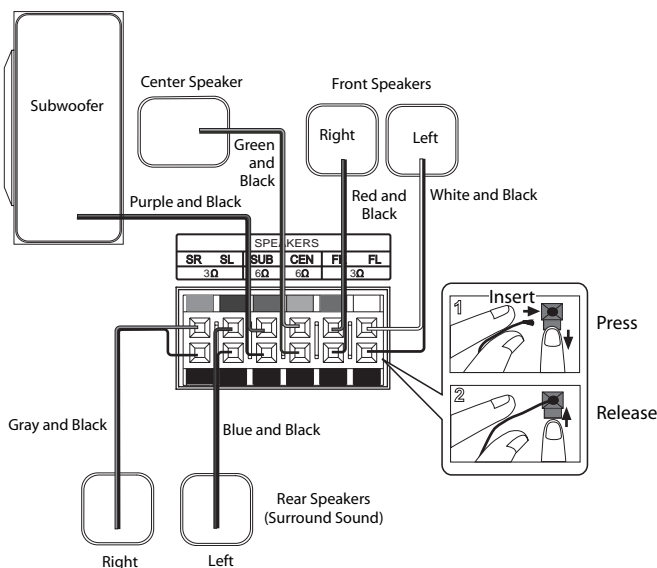

To adjust each speaker volume level for optimum listening experience.

- 1) Press **LEVEL** button on the remote control to select FL (front Left speaker) on the unit display.
- 2) Press **▲** or **▼** buttons to adjust the value up or down (between -10dB and +10dB).
- 3) Repeat step (1) and (2) for the other speakers FR, CT, SW, SL, SR.

Speaker gains may be set to levels of up to +10dB, actual max levels may also depend on your Volume Setting.

Note: When connecting the speakers, make sure the polarities (“+” speaker wire to “+” on the receiver) of speaker wires and terminals match. For example, red wire to red terminal on the receiver. If the cords are reversed, the sound will be distorted. Do not let the speaker wires touch each other, it will damage the system’s amplifier.

Connections and Setup

Positioning Speakers

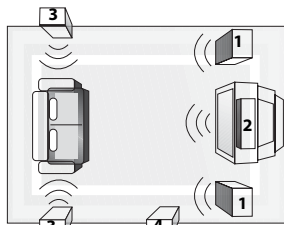

Courtesy Dolby Laboratories

1. Left, Right (Front Speakers)

Front speakers carry primarily music and sound effects.

2. Center

In surround mode, the center speaker carries most of the dialog as well as music and effects.

It should be set between the left and right speakers.

3. Surround (Rear Speakers)

The surround speakers' overall sound balance should be as close as possible to the front speakers. Proper placement is vital to establish an evenly distributed sound field.

4. Subwoofer

A subwoofer is designed to reproduce powerful low bass effects (explosions, the rumble of spaceships, etc.).



Note:

Center speaker provided with this unit is magnetically shielded to protect your TV set. It is not recommended to place speakers without magnetic shield near the TV set.

Front Speaker Placement

For best results, follow the speaker placement below.

Alignment

Align the center speaker evenly with (A) or slightly behind (B) (the left and right speakers), but not ahead of them.

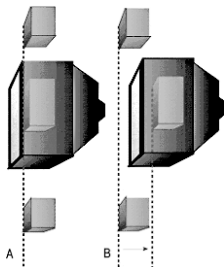

Angle

Place the left and right speakers to form a 45-degree angle with your favorite viewing position to duplicate the soundtrack mixer's perspective.

Height

The three front speakers should be as close as possible to the same height. This often requires placing the center speaker directly on top (A) or beneath (B) the TV set.

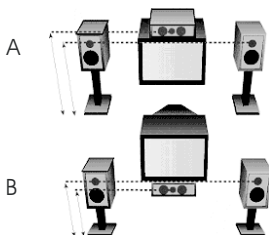

Connections and Setup

Better Surround Placement

Location

If possible, place surround speakers to either side of the listening area, not behind it.

Height

If space permits, install surround speakers 2-3 feet above viewers. This helps to minimize localization effects.

Aiming

Aim surround speakers straight across the room, not down at viewers, to help create a more open, spacious surround sound field.

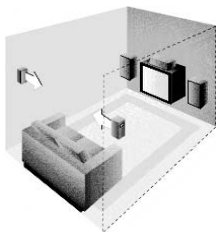

Alternative Surround Placement

Rear wall

If rear wall mounting is the only choice, aim the speakers at each other (A), towards the front (B) or towards the sidewalls (C, D).

Experiment with placement until sounds seem to surround you, rather than come from behind you.

No adjacent walls

Surround speakers can go on stands facing each other to approximate sidewall mounting (A), or to the sides or rear of the viewing area, aimed upwards; they can go right on the floor, or preferably, a few feet off the floor such as on end tables (B).

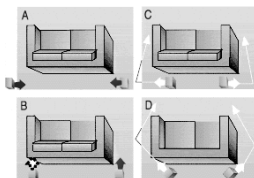

Test Tone/Channel Balance

Channel Balance

Your receiver is equipped with a test signal generator to help balance the audio level for each channel (see Page 9 & 13 for details).

Level Adjustment and Surround Channel Level Expectation

Even though you adjust the surround channel to be as loud as the others on the test signal, you may find that surround channels seems quieter for actual TV and Movie content. This is because producers use surround for subtle atmospheric and ambience, and only rarely for special effects.

Overview of Controls - Front Panel Controls

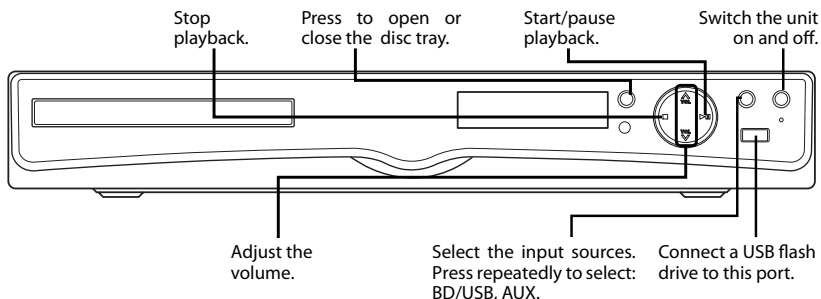

Overview of Controls

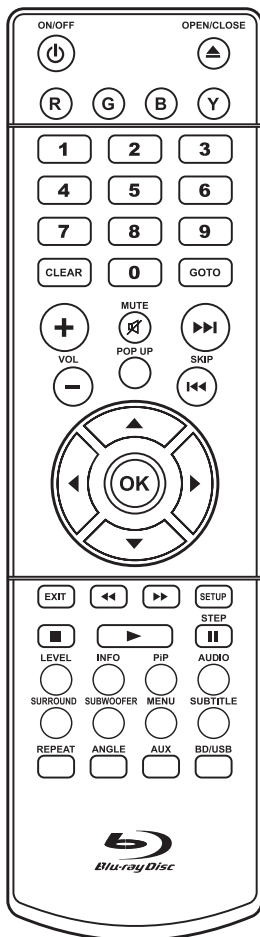

ON/OFF

Press to turn on your unit, or put your unit in standby mode. When your unit is in standby mode, power is still entering your unit. To disconnect power, unplug the power cord.

OPEN/CLOSE

Press to open or close the disc tray.

R(red), G(green), B(blue), Y(yellow)

When playing a Blu-ray Disc that has a Java application, press to control playback. For more information, see the documentation that came with the Blu-ray Disc.

Numbers

In playback mode, press **GOTO** button, then press the number buttons to enter a title, chapter, track or time.

CLEAR

Press to clear an input.

GOTO

Press to search for a title, chapter, track or time.

VOL+/-

Press to increase or decrease the volume.

MUTE

Press to turn off sound. Press again to turn the sound back on.

POP UP

During Blu-ray Disc playback, press to open a menu that lets you control Blu-ray Disc playback.

During DVD playback, press to open the DVD title menu (if available).

SKIP ►►/◄◄

Press to go to the next or previous chapter (Blu-ray Disc/DVD) or track (CD).



Navigate through the menus.

OK

Confirms your selection.

EXIT

Press to return to the previous menu.

◄◄ REV

Press to fast reverse.

►► FWD

Press to fast forward.

SETUP

Press to access the Dimmer (DIM), Sleep (SLP) and test tone setting (the settings will be shown of the unit's front panel display).

Overview of Controls

Dimmer Setup

To adjust the brightness of display on front of Blu-ray disc player.

Press **SETUP** button and the "DIM 0" appears, then use ▲/▼ buttons to select "DIM 0", "DIM 1" or "DIM 2".

Sleep Setup

Press **SETUP** button and the "DIM 0" appears. Use ◀/▶ buttons to select "SLP OFF", then press the ▲/▼ buttons select 30M, 60M, 90M or 120M.

The unit will automatically turn off once it counts down the sleep time.

Test Tone

Press **SETUP** button and the "DIM 0" appears. Use ◀/▶ buttons to select "TEST OFF", then press ▲/▼ buttons to select FL (front left speaker), FR (front right speaker), CT (center speaker), SW (subwoofer), SL (surround left speaker) or SR (surround right speaker), then press **OK** button. You'll hear a test tone coming from the speaker you select. Press **EXIT** button to exit this function.

To adjust the speaker volume levels, press **LEVEL** button and use ◀/▶ buttons to select the speaker you are testing, then use ▲ or ▼ buttons to adjust the value up or down (between -10dB and +10dB).

STOP

Press to stop playback.

PLAY

Press to start or resume playback.

STEP/II

Pause playback, frame advance.

LEVEL

Toggle channels for different level settings. Adjusts the value using ▲ or ▼ buttons.

INFO

Accesses the Info menu.

PIP

Press to turn PiP (picture in picture) mode on or off. This function is only available by Blu-ray discs if available on disc.

AUDIO

Accesses the audio function. PiP Audio can be selected through cursor if secondary Audio is available on the Blu-ray Disc.

SURROUND

In AUX mode, press to show current sound mode (CH 5.1 or STEREO) on the front of Blu-ray disc player display.

To change the current setting, first press the **SURROUND** button, then use ▲/▼ buttons on the remote control to select STEREO or CH5.1.

SUBWOOFER

Press to display current Subwoofer setting (BALANCE/SOFT/PWRFUL<Powerful>/STRONG).

To change settings, first press to access the current Subwoofer setting, then use ▲/▼ buttons on the remote control to change the current setting.

MENU

Accesses the disc menu during playback (on DVD).

SUBTITLE

Accesses the subtitle function.

PiP Subtitle can be selected through cursor if secondary subtitle is available on the Blu-ray Disc.

REPEAT

Press to repeat the current title, chapter, track, or repeat all. This button is only used for DVD/CD discs.

ANGLE

Accesses the camera angle function for Blu-ray or DVD discs if available.

AUX

Press to select AUX input source.

BD/USB

Press to select the BD/USB mode.



Note

Insert the two "AAA" (included with this unit) batteries into the remote control prior to use.

Quick Setup

When turned on for the first time or after resetting it to the factory default, the Quick Setup menu will pop up as following.

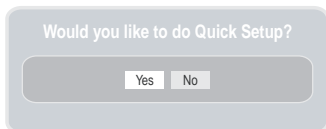

Follow the below steps to make the basic settings for using the Blu-ray player.

1. Press **OK** to perform Quick Setup.
 - To exit Quick Setup, press **▶** button to select "No" and then press **OK**.

The display for Player Menu settings selection appears.

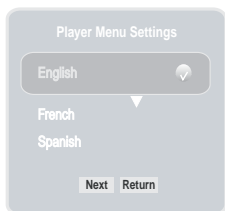

2. Press **▲** or **▼** button to select English, French or Spanish and press **OK**.
3. Press **▼** button to select "Next" and press **OK**, then the display for Resolution selection appears.

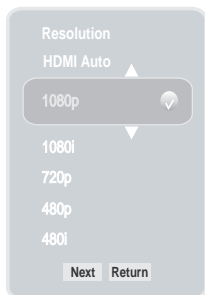

4. Press **▲** or **▼** button to select HDMI Auto, 1080p, 1080i, 720p, 480p or 480i and press **OK**. (For details about the Resolution, please see page20.)
5. Press **▼** button to select "Next" and press **OK**, then the display for TV Aspect selection appears.

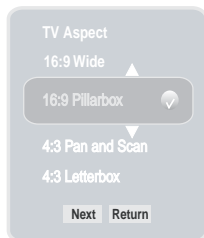

6. Press **▲** or **▼** button to select 16:9 Wide, 16:9 Pillarbox, 4:3 Pan and Scan or 4:3 Letterbox and press **OK**. (For details about the TV Aspect, please see page20.)
7. Press **▼** button to select "Next" and press **OK**. The display for "Quick Setup complete" appears and press **OK** to exit the setup.

Notes

- You can reset the settings to the factory settings (see page 22).
- You can run Quick Setup again from "Quick Setup" in "Settings" (see page 23).

Playing a Blu-ray Disc or DVD

Regional Coding

This unit has been designed to play back BD-video encoded for region "A" and DVD-video encoded for region "1". You cannot play back BD-video or DVD-video that are labeled for other regions. Look for the symbols on the right on your BD-video or DVD-video. If these region symbols do not appear on your BD-video or DVD-video, you cannot play back the disc in this unit. The letter or number inside the globe refers to region of the world. A BD-video or DVD-video labeled for a specific region can only be played back in the unit with the same region code.

Basic playback (Blu-ray Disc or DVD)

1. Turn on your television set.
2. Press **ON/OFF** button on the remote control or **ON/STANDBY** button located on the unit's front panel. Press **BD/USB** button on the remote control.
3. Press **▲ OPEN/CLOSE** button to open the disc tray.
4. Place a disc onto the disc tray with the label side up.
5. Press **▲ OPEN/CLOSE** button again to close the disc tray.
6. After loading a disc, a selection menu appears on the screen and press **▲** or **▼** button to select **BD-ROM** (or **DVD**), then press **OK** or **▶** button start playback.
 - If the disc menu appears, select the Play option and press **OK** button to begin playback.

Playback

- To start playback, press **▶** button.

Pause

- To pause playback, press **||** button.
- To resume normal playback, press **▶** button.

Frame advance

- Press **PAUSE ||** twice. "Step Fwd" is displayed.
- Each time you press **PAUSE** button, the picture advances one frame.
- Press **▶** to resume normal playback.

Stop

- To stop playback, press **■** button. The **Settings** menu is displayed.
- To resume playback, press **▶** on the remote control or press **▲** or **▼** button to select DVD/BD-ROM, then press **OK** button. Depending on the disc, playback starts where it stopped or at the beginning of the disc.

Accelerated play

- To fast forward or fast reverse, press **▶▶** (fast forward) or **◀◀** (fast reverse).
- Each time you press one of these buttons, the fast-forward or fast-reverse speed increases from Fast X2, Fast X4, Fast X8, Fast X16, Fast X32, Fast X64, to Fast X128. Press **▶** to resume normal playback.

Changing chapter/track

- Press either the **SKIP ◀◀** or **▶▶** button according to the desired direction.
- Press the **SKIP ◀◀** button to skip to the start of the current chapter or skip to previous chapters.
- Press the **SKIP ▶▶** button to skip to the beginning of the next chapter.

Displaying Blu-ray Disc information

- Press **INFO** button, your unit displays information about the Disc, such as type of disc, elapsed time of the current title, total time of the current title, total number of chapters.
- Press **INFO** button again to exit.

Note: The information displayed for discs other than Blu-ray Discs will be different.

Special Functions

Searching for a title, chapter or elapsed time

1. During playback, press **GOTO** button one or more times to select a search mode.
 - Press once to select the **Goto Title** mode.
 - Press twice to select the **Goto Chapter** mode.
 - Press three times to select the **Goto Time** mode.
2. Press the number buttons to enter the title number, chapter number or time, then press **OK** button. Your unit goes to the title, chapter, or time you entered.

Repeating a title, chapter or CD track

- Press **REPEAT** button one or more times to select a repeat mode.

Using PiP (picture-in-picture) mode

Some Blu-ray Discs are compatible with picture-in-picture (PiP) mode. In PiP mode, the primary video is displayed on the full screen, and the secondary video is displayed in a small window.



- Press **PiP** button to turn PiP mode on or off.
- Press **AUDIO** or **SUBTITLE** button to turn the audio/subtitle for the video in the PiP window on or off. Then use cursor buttons and **OK** button to select your preferred options.

Notes

- The available options of Audio vary from different disc format.
- PiP Subtitle is not available for all discs. It only applies to Blu-ray discs that supports picture-in-picture features.
- Some discs allow you to turn PiP on/off only via the disc menu.

Using a disc popup menu

1. During Blu-ray or DVD playback, press **POP UP** button. The Blu-ray popup menu or the title menu of DVD disc opens.
2. Press **▲**, **▼**, **◀** or **▶** buttons to select an option, then press **OK** button.

Selecting a play source

- Press **SOURCE** button on the front panel of the unit repeatedly to select **BD/USB, AUX**.
- Press **BD/USB** button on the remote control to select **BD/USB** mode.
- Press **AUX** button on the remote control to select **AUX** mode.

Selecting the audio mode

1. Press **AUDIO** button. Your unit displays audio channel information, such as **01/03 Eng Dolby Digital. 01** indicates the currently selected audio channel. **03** indicates the total number of audio channels. **Eng** (English) indicates the audio language. **Dolby Digital** describes the currently selected audio format.
2. Press **▶** button and press **▲** or **▼** button to select an audio mode, then press **OK** button.

Selecting the camera angle (Blu-ray Disc and DVD disc)

Some discs offer different camera angles for specific scenes. To change the camera angle:

1. Press **ANGLE** button on the remote control. The selected angle will be displayed on the display bar at the top of the TV screen.
2. Press **▶** button and press **▲** or **▼** button to select the desired angle, then press **OK** button. If the disc was recorded using a single camera angle, this function is not available.

Selecting subtitles

You can display subtitles on the TV screen and select a subtitle language from those included on the DVDs.

1. Press **SUBTITLE** button on the remote control. The selected language will be displayed on the display bar at the top of the TV screen.
2. Press **▶** button and press **▲** or **▼** button to select your desired language, then press **OK** button.

PiP Subtitle can be selected through cursor if secondary subtitle is available on the Blu-ray Disc.

Playing an audio CD

1. Press **ON/OFF** button on the remote control or **ON/STANDBY** button located on the unit's front panel.
2. Press **▲ OPEN/CLOSE** button to open the disc tray.
3. Place a CD on the disc tray with the label facing up, then press **▲ OPEN/CLOSE** button to close the disc tray. It may take a few seconds for the CD to load.
4. After loading a disc, playback starts automatically.
5. To eject the CD, press **▲ OPEN/CLOSE** button.

To control audio CD playback:

- To start playback, press **▶** button.
- To pause playback, press **⏸** button. The sound is muted when your unit is in pause mode. To resume normal playback, press **▶** button.
- To stop playback completely, press **■** button. To start playback again, press **▶** button. Playback starts at the beginning of the CD.
- To fast-forward, press **▶▶** button. To resume normal playback, press **▶** button.
- To fast-reverse, press **◀◀** button. To resume normal playback, press **▶** button.
- Press either the **◀◀** or **▶▶** button according to the desired direction.

Press the **◀◀** button to skip to the start of the current track or skip to previous tracks. Press the **▶▶** button to skip to the beginning of the next track.

- To select a track, press **GOTO** button once, enter the track number with the number buttons, then press **OK** button.

Playing files on a data disc

You can play JPEG files that have been recorded on a CD-R or CD-RW on this unit.

Insert a data disc containing picture files.

A selection menu appears on the screen:

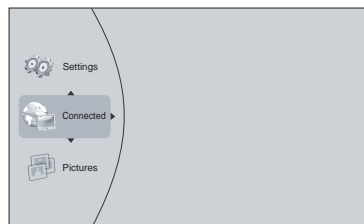

To view JPEG files

1. Press **▲** or **▼** button to select **Pictures**, then press **OK** button.
2. Press **▲**, **▼**, **◀** or **▶** button to select a file (or a folder) and press **OK** or **▶** button to start playback. If you selected a folder, the files in this folder are displayed. Press **▲** or **▼** button to select a file and press **OK** or **▶** button to start playback.
3. Press **■** button to return to the Pictures menu.
4. Press **▲** or **▼** button to select an option, then press **OK** button.
 - **Settings** - This option enables you to define a Slide Show Effects value (None, Horizontal Scroll, Fade and Shutter) and Slide Show Delay (5 Seconds, 2 Seconds, 1 Seconds, No Delay, 10 Seconds, 15 Seconds and 30 Seconds). After setting, press **▼** to highlight OK and then press **OK** button to confirm.
 - **Main Menu** - Returns to the main menu.
 - **Previous folder** - Returns to the previous folder.
 - **Start Slide Show** - This option enables you to view picture (files) one after another automatically.

Using a USB device

Playing USB flash (“thumb”) drive

Insert a USB thumb drive containing picture files into your unit. A selection menu appears on the screen:

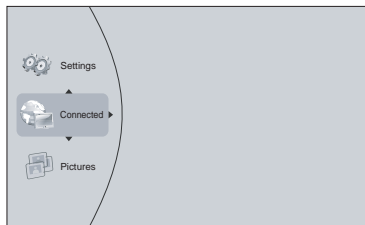

Press ▲ or ▼ button to select **Pictures**, then press **OK** button.

(To play pictures, please see **Playing files on a data disc** for details.)

If an optical disc containing picture files is inserted at the same time, the system will enter the source selection screen and you can press ▲ or ▼ button to choose **Optical Disc** or **USB**.

If you choose Optical Disc option, please follow the operation instructions in “Playing files on a data disc”.



Notes

- It is recommended to plug the USB flash drive when the unit is off.
- It does not support USB hard disc mass storage device, multi-card reader and other USB computer peripheral.
- Do not disconnect the USB flash drive when you are playing it, it may corrupt the data.
- If you cannot easily insert the USB device, you may have inserted it incorrectly. Try to turnover the device and then insert again.

Watching movies with VUDU

VUDU is an online service that allows you to rent or purchase HD movies. It also provides a wide range of interesting and useful online apps. To use the VUDU movie service or access VUDU Apps, please ensure your unit is successfully connected to a network with internet access. (See “Network Setting” section on page 23).

Step 1:

Creating a VUDU account on your player

- a. In home menu, press ▲ or ▼ button to select **Connected**, and then press ► or OK button to confirm.
- b. Follow the instructions to create an account, it will ask for an email address.
- c. Enter YOUR email address using the keyboard that appears on the screen. VUDU will then display a message on the TV “**Sending you an email**”.

Step 2:

Creating a VUDU account on your PC

- a. VUDU will send you an email with a hyper-link; click on the link.
- b. In the VUDU page that comes up on your PC’s browser after clicking the link, enter the e-mail and password of the owner of the account.
- c. VUDU will then display a message “**Enabling your device to view movies. The email message on your TV screen will disappear when done**”.

Step 3:

Now that you’ve successfully created a VUDU account, you can access VUDU simply by selecting **Connected** from the main menu.

Note

To exit VUDU and return to the unit’s Main Menu, press the **Red (“R”)** button on your remote control.

Enjoying BD-Live

Some BD-ROMs contains BD-Live features that can be downloaded to the external memory (local storage) for enjoyment.

In order to access BD-Live functions, the Blu-ray disc player must be properly configured for BD-Live internet access, and it must be equipped with additional memory (USB Flash Drive).

1. Insert a USB Flash Drive of at least 1GB capacity (not supplied) into the USB jack on the front panel of the Blu-ray disc player.
 - The USB device is used as the local storage.
 - Make sure that the USB device is properly inserted into the Blu-ray disc player.
 - If there is not at least 100Mbyte of free space on the USB device, you should choose **"Erase Blu-ray Storage"** from the BD-Live settings (see page 23).
2. Connect the Blu-ray disc player to a network (see page 8).
3. Turn the Blu-ray disc player on.
4. Set "BD-Live Internet Access" to **"Limit Access"** or **"Always Allow Access"** in BD-Live Settings (see page 23).
5. Insert a BD-ROM with BD-Live and select the BD-Live selection following the instructions on the disc menu.
 - The operation method differs depending on your BD-ROM. Please refer to the instructions coming with the disc.

Notes

- Do not remove the USB device when using the BD-Live function.
- Depending on your connection environment, it may take time to connect to the Internet or the Internet may not be connected.

IMPORTANT!

Many BD-Live compatible discs require content to be downloaded onto USB flash drive in order to access the available BD-Live features. A USB flash drive with at least 1GB of free space needs to be inserted prior to inserting the BD-Live compatible disc.

AUX

You can connect Audio or Audio-Video devices such as a TV, Game System, VCR, Satellite or Cable Box to this unit using the AUDIO IN jacks at the back of the unit. The AUX input provides an analog audio connection especially suitable for older devices. This unit will take the audio from the connected device and play the audio through the speakers.

Connecting auxiliary components

Refer to **Connecting AUDIO IN from external sources such as TV** for details on connecting the auxiliary components to the unit.

Selecting AUX mode

Press either **SOURCE** button on the main unit or **AUX** button on the remote control to select AUX mode.

Sound output in AUX mode

- You may change the Surround Sound setting to STEREO mode if you like (see instructions under **Overview of Controls**). However, we recommend you leave the system in full surround mode.
- If the auxiliary audio signal is mono, there will be no output from some speakers in full surround mode.

The Settings Menu

The Settings menu appears automatically when the unit is in BD/USB stop mode. Use ▲ or ▼ button to select **Settings**.

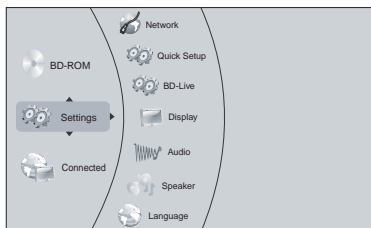

Language Settings

1. In the main menu of **Settings**, press ► button, then use ▲ or ▼ button to select **Language**.
2. Press ► button and press ▲ or ▼ button to select an option, then press **OK** button.
3. Press ▲ or ▼ button to select the language you want, then press **OK** button to confirm your selection.
4. Press ◀ or **EXIT** button to go to the previous menu.



Notes

- If the selected language is not available on a disc, the disc's language will be used instead.
- If the language chosen is available, it is automatically selected when you display the subtitles or press **SUBTITLE** button on the remote control. Otherwise, the subtitle language indicated on the disc is selected.

Display Settings

1. In the main menu of **Settings**, press ► button, then use ▲ or ▼ button to select **Display**.
2. Press ► button and press ▲ or ▼ button to select an option, then press **OK** button.
3. Press ▲ or ▼ button to select the desired option, and then press **OK** button to confirm your selection.
4. Press ◀ or **EXIT** button to go to the previous menu.

Resolution

You can define the video output resolution in this option.

HDMI Auto: If your TV is a high-definition TV (HDTV), is connected to the HDMI jack on your player and you want your player to set the output resolution based on information exchanged between the TV and your player over the HDMI cable.

1080p: If the TV is a high-definition TV (HDTV) capable of 1080p (any frame rate) connected to the HDMI jack on your player.

1080i: If your TV is a high-definition TV (HDTV) capable of 1080i only.

720p: If your TV is a high-definition TV (HDTV) capable of 720p only.

480p: If your TV is an enhanced-definition TV (EDTV).

480i: If your TV is a standard-definition NTSC (analog) TV.

Notes

- Selecting a resolution your TV does not support could result in an unstable picture or loss of the picture. See the documentation that came with the TV to find the resolutions the TV supports.
- Only the HDMI output on your unit supports 1080p video output at any frame rate. If the TV is connected to the component output, the video output is limited to 1080i or lower.

TV Aspect

16:9 wide, 16:9 Pillarbox, 4:3 Pan and Scan, and 4:3 Letterbox are available for your choice.

The Settings Menu

Film Mode

Movies are recorded on film at a rate of 24 pictures (frames) per second. Many of the movies on Blu-ray discs are recorded on the discs at this frame rate. However, not all TVs can display 24 progressive frames/second of video. If the TV cannot display this frame rate, you need to turn off **Film Mode**.

Note

Only your unit's HDMI output supports 1080p video output at any frame rate. The component outputs are limited to 1080i, regardless of the **Film Mode** setting.

Deep Color

This option allows you to turn off the Deep Color (color depth) setting for video signals output from the HDMI OUT jack.

Connecting the player to a TV that supports Deep Color allows more accurate color reproduction than when connecting it to a TV that does not support Deep Color. It is recommended to set this option Off if the picture is unstable or colors appear unnatural.

Audio Setting

1. In the main menu of **Settings**, press ► button, then use ▲ or ▼ button to select **Audio**.
2. Press ► button and press ▲ or ▼ button to select an option, then press **OK** button.
3. Press ▲ or ▼ buttons to select the desired option, and then press **OK** button to confirm your selection.
4. Press ◀ or **EXIT** button to go to the previous menu.

PCM Downsampling

If you chose to use an external Surround Sound Receiver to play audio via your HDMI connection, you can choose a downsampling rate to match the capabilities of your Receiver.

Notes

- The PCM Downsampling and Digital Output settings are only necessary if you don't plan to use your Blu-ray Home Theater for playback of audio, and instead plan to use an external Audio Receiver for playback of HDMI audio.
- Incorrectly setting the digital audio output's PCM sampling rate too high may result in unpredictable audio playback.

Digital Output:

- **PCM Stereo** — Sets the HDMI audio format to PCM Stereo, this is useful if you have an audio receiver connected that is not a 5.1 channel receiver.
- **Bitstream Legacy** — Sends a DTS or Dolby Digital bitstream from the disc over the HDMI connections. Blu-ray audio is limited to the soundtrack for the main movie (no PIP audio).
- **Bitstream Mixed** — Sends a mixed (PIP audio and movie audio) DTS audio stream over the HDMI connections. This mode is primarily intended for use when you want to hear both PIP audio and the movie audio over an external Audio Receiver.
- **PCM 5.1** — Sends a PCM audio signal of up to 5.1 channels over the HDMI connection.

Dynamic Range Control:

Dynamic Range Control allows you to make the loud parts of a movie's audio track quieter than they would be in the theatre, without making the dialog of the actors any quieter.

This would be useful, for instance, when you want to watch a movie in the evening when others might be sleeping.

Note: This setup menu item **has no effect** unless:

- You have selected "Bitstream Mixed" in the Blu-ray disc player's audio setup menu.

When **Dynamic Range Control** is set to **Off**, movie soundtracks are played with the standard dynamic range.

When movie soundtracks are played at low volume or from smaller speakers, you can set **Dynamic Range Control** to **On**. Your player applies appropriate compression to make low-level content more intelligible and prevent dramatic passages from getting too loud.

Selecting the "**Auto**" option turns on the Dynamic Range Control for all BD movie soundtracks except Dolby TruHD.

The Settings Menu

Stereo Downmix:

Allows you to downmix the multi-channel audio into fewer channels.

- **Stereo (LoRo)** — Downmixes the multi-channel audio into two channel stereo. Choose when the Blu-ray disc player is connected to the equipment that does not support virtual surround function such as Dolby Pro Logic.
- **Surround Encoded (LtRt)** — Downmixes the multichannel audio into surround compatible stereo. Choose when the Blu-ray disc player is connected to the equipment that supports virtual surround function such as Dolby Pro Logic.

Speaker Settings

Once the speakers are connected to the system, you can set the speakers to obtain the best possible surround sound.

1. In the main menu of **Settings**, press **▶** button, then use **▲** or **▼** button to select **Speaker**, then press **OK**.
2. Use **▲**, **▼**, **◀** or **▶** to highlight the desired speaker, then press **OK**.
3. Press **▲** or **▼** to select the desired audio signal, and then press **OK** to confirm.
4. Press **◀** or **EXIT** to go to the previous menu.

Note

Setting a speaker to "Off" will result in no sound being delivered to this speaker. We highly recommend you leave all speakers set to "On".

System Settings

1. In the main menu of **Settings**, press **▶** button, then use **▲** or **▼** button to select **System**.
2. Press **▶** button and press **▲** or **▼** button to select an option, then press **OK** button.
3. Press **▲** or **▼** buttons to select the desired option, and then press **OK** button to confirm your selection.
4. Press **◀** or **EXIT** button to go to the previous menu.

Optical Disc AutoPlay

If **On** is selected, a disc will automatically play when you load the disc or when you access the BD/USB Menu. If **Off** is selected, the disc won't play automatically (it will play when you press the Play button).

Screen Saver Duration

This Blu-ray disc player has a screen saver feature when your player is inactive. You can set the interval time you want your player to wait before activating the screen saver.

Auto Power Down

This power-saving option defines the time duration upon which the unit shuts down automatically as a result of inactivity.

Restore Factory Defaults

Restore Factory Settings: If you choose **Ok** in the prompt message box and press OK button, all settings will be restored to the factory defaults.

Deactivate Vudu: If you choose **Ok** in the prompt message box and press OK button, Vudu will be deactivated (the unit will be de-registered).

Update Via Network

This option allows to update your product software via the internet.

The Settings Menu

Network Settings

1. In the main menu of **Settings**, press **▶** button, then use **▲** or **▼** button to select **Network**.
2. Press **▶** button.
3. Press **▲** or **▼** button to select **Wired**, then press **OK** button. The IP Settings screen appears. If the network connection is active, **Link Up** appears next to **Link Status**. If the network connection is not active, **Link Down** displays next to **Link Status**.
4. Press **▲** or **▼** button to select **IP Mode**, then press **OK** button.

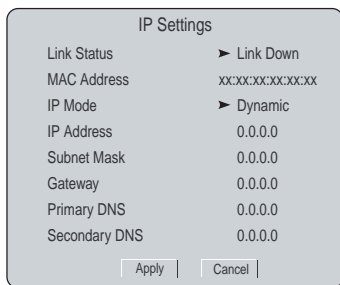

5. Press **▲** or **▼** button to select an IP Mode. You can select:
 - **Dynamic** — Uses DHCP to automatically obtain an IP address.
 - **Manual** — Lets you manually configure network settings, such as IP address, subnet mask, and gateway settings.
 - **Off** — Disables the network interface.
6. Press **◀** or **EXIT** button to go to the previous menu.

Network Test

Selecting the **Network Test** will cause the player to attempt to communicate with your home network, and if successful, with a known internet address. If both attempts are successful, your network connection should be good. If the player can successfully connect to your home network, but not to the known internet address, your internet service may be “down”, or your security firewall may be blocking access of the player to the internet.

Quick Setup

1. In the main menu of **Settings**, press **▶** button, then use **▲** or **▼** button to select **Quick Setup**, and then press **OK** to confirm.
2. Press **OK** to perform Quick Setup.
To exit the setup menu:
 - Use **▼** button to highlight “No thanks. I’ll go through the full setup menu later”, and then press **OK**.
 - Or press **◀** button directly.
3. Follow the on-screen instructions to customize the following settings to your preference:
 - **Player Menu Settings**
 - **Resolution**
 - **TV Aspect**
4. After finishing all settings, select Exit and press **OK** to exit the setup.
(Please see page 14 for details.)

BD-Live

1. In the main menu of **Settings**, press **▶** button, then use **▲** or **▼** button to select **BD-Live**.
2. Press **▶** button and press **▲** or **▼** button to select an option, then press **OK** button.
3. Press **▲** or **▼** buttons to select the desired option, and then press **OK** button to confirm your selection.
4. Press **◀** or **EXIT** button to go to the previous menu.

BD-Live Internet Access

- **Limit Access** — Allows Internet access with valid “BDLive” network access approval.
- **Always Allow Access** — Always allows BD-Live Internet access.
- **Prohibit Access** — Never allows BD-Live Internet access.

BD-Live Storage

The available storage space is displayed next to BD-Live Storage.

Erase Blu-ray Storage

If you choose **OK** to erase Blu-ray storage, all bookmarks and BD-Live content saved in memory will be deleted.

Troubleshooting

The unit does not switch on.

- Make sure it is plugged in.
- Press **ON/OFF** button on the remote control or **ON /STANDBY** button on the front of the unit.

The device switches off spontaneously.

- If the SLEEP SETUP (see page 12 and 13 for details) is set to 30, 60, 90, 120 minutes, the device will turn off automatically once it counts down the sleep time. If Auto Power Down in System settings is set to 30, 45, 60 minutes, the device will switch off automatically if it remains idle and no activities are made. Switch it on again.

Blu-ray Disc or DVD does not play

- Make sure that the disc has the correct region code.
- Some Blu-ray discs will only play over an HDMI connection.
- It might be impossible to read the disc.
- Insert the disc with the printed side facing up.
- Check that the disc can actually be played by this device.
- Clean the disc.

Picture-in-Picture(PiP) does not work on a Blu-ray Disc

- Make sure that the disc supports PiP mode.

When playing a BD-Live disc, the screen is black

- Erase BD Storage.
- Make sure that the internet connection is working.
- Make sure that the internet cable is connected securely and correctly to the unit and the internet jack. Some discs require an Internet connection to play.

Cannot connect to the internet

- Make sure that the Internet connection is set up correctly.
- Test the Internet connection to make sure that it is working.
- Make sure that the BD-Live Internet Access option is not set to Prohibit Access.

After connecting to the Internet, I cannot download a file

- Erase BD Storage.
- Make sure that the internet connection is working.
- Try a different USB flash drive.

File was downloaded, but playback from file pauses

- Make sure that the USB flash drive is a USB 2.0 device. Using a USB1.1 device may cause pausing.
- Try a different USB flash drive.

There is no picture.

- Check that the TV is operating correctly.
- Check the connections.
- Select the AV input assigned to the unit on the TV.
- Replace the HDMI cable with a better one. A bad HDMI cable can cause loss of video.

The picture is of poor quality (with snow or lines).

- Check the connections.

There is no sound or the sound is of poor quality.

- Check the connections.
- Make sure the speakers are connected.
- Make sure the MUTE function is not on.

No surround sound.

- Check to see if system is actually in full Surround mode (see Audio setting & Speaker setting on page 21, 22). For AUX mode, press the **SURROUND** button on the remote control - the front panel display should indicate the current setting (STEREO or CH 5.1). If current setting is **STEREO**, the surround speakers and center speaker will be inactive. Press **▲/▼** button to change surround mode from **STEREO**.
Note: Not all discs, media files, or audio sources provide surround audio, thus lack of audio to surround speakers may be due to the actual source being played.

I can't find my file in the JPEG listing.

- Make sure the file name is valid.

The remote control does not work or works only intermittently.

- Check that batteries are inserted or change them.
- Aim the remote control at the unit. The infrared beam must not be blocked or interrupted.
- Check that the remote control is configured to control the device you are trying to operate with it.

The subtitles do not appear.

- Check that the BD/DVD disc provides subtitles.
- Refer to the section on how to display subtitles.

The disc menu language is not the correct one.

- The disc menu language has not been set up.
- The language of your choice is not available on the disc.

Additional Information

Precautions

Use

- If your unit has been stored in a cool place for any length of time, during a journey for example, wait for about 2 hours before using it.
- The openings located on the top and bottom are for ventilation and must not be obstructed.
- During thunderstorms, we recommend that you isolate the unit from the electrical supply so that it is not damaged by electrical or electromagnetic surges.
- This unit is designed for continuous use. Switching off the unit to standby mode does not disconnect it from the mains supply. To completely isolate the equipment, remove the plug from the mains jack as some components remain connected to the electrical supply.
- If you notice any burning or smoke, disconnect the unit immediately to avoid any risk of electrocution.
- Do not attempt to look inside the unit through the disc tray opening or any other opening. You may be electrocuted or exposed to laser radiation.
- This unit is for domestic use only and must not be used for industrial purposes.
- Total or partial copying of recordings protected by copyright legislation, without the explicit permission of the holder of the rights, contravenes current legislation. Copying or downloading music files for sale or any other business purpose constitutes or could constitute a violation of copyright law.

Cleaning

- Use a soft, dry, clean cloth. Regularly dust the vents at the back or sides.
- Using solvents, abrasive or alcohol-based products risks damaging the unit.
- If an object or liquid enters inside the unit, unplug it immediately and have it checked by an authorized servicer or service center.

Handling and Caring for Discs

- Handle your discs with care. Hold the disc with your fingers at the edges or through the hole.
- Insert the disc with the label facing up (for a single-sided disc).
- Place the disc properly into the tray in the allotted holder.
- Use a soft cloth to clean discs if necessary, always wiping from the centre to the edge.
- Always put discs back in their cases after use and store in a vertical position.
- Do not close the tray with two discs in it or with a disc not sitting correctly in the holder.
- Do not play cracked, chipped or warped discs nor try to repair them with adhesive tape or glue.
- Do not write on a disc.
- Do not move the unit when a disc is being played.
- Do not scratch discs or store them in places exposed to direct sunlight, high humidity or high temperatures.
- Do not use aerosol cleaners, benzene, anti-static liquids or any other solvent for cleaning discs. When cleaning, wipe gently with a soft damp (water only) cloth from the centre to the edge, avoiding circular motions, which could cause scratches and interference during playback.

Additional Information

Compatible Formats

In order to ensure playback, discs must conform with BD, DVD or CD standards. This unit may not play some recordings or files due to differences in recording formats, software used and disc types.

BD-ROM

BD-ROMs (Blu-ray Disc Read-Only Memory) are commercially produced discs and are available in the same capacities as BD below. Other than conventional movie and video contents, these discs have enhanced features such as interactive content, menu operations using pop-up menus (see below), selection of subtitle display, and slideshow. Although a BD-ROM may contain any form of data, most BD ROM discs will contain movies in High Definition format, for playback on Blu-ray Disc players.

Blu-ray Disc (BD)

A disc format developed for recording/playing high-definition (HD) video (for HDTV, etc.), and for storing large amounts of data. A single layer Blu-ray Disc holds up to 25 GB, and a dual-layer Blu-ray Disc holds up to 50 GB of data.

DVD-Video

Digital video discs - 12 cm, single or double sided, single or dual layer. DVDs are high density optical discs on which high quality picture and audio are recorded by means of digital signals.

DVD-R, DVD-RW, DVD+R, DVD+RW

Most DVD-R and DVD+R (one recording only), DVD-RW and DVD+RW discs (rewritable), depending on the DVD writer and discs used. Recordings using DVD-R and DVD-RW discs must be made in Video DVD mode. Recordings using DVD+RW discs must be made in accordance with the specifications for DVD+RW discs with a 4.7 GB capacity.



Audio CDs

Audio CDs (12 cm).

CD-R, CD-RW

Most CD-R (one recording only) and CD-RW discs (rewritable).

CD-Rs written during a multisession recording can be played, provided that the session has ended before the disc is played (depending on the write software).

However, depending on the condition of the CD-writer, computer and the disc used, you may find that not all discs will play. When playing a CD-R disc, it is normal for the unit to take up to 60 seconds to recognize the disc before starting to play.

If the disc is not recognized after a period of 120 seconds, remove the disc, and insert it again.

- Do not use its full capacity.
- CD-Rs should be preferably used instead of CD-RWs (rewritable CDs) as, in certain cases, CD-RW playback may be faulty.
- Use reliable, good-quality CD write software.
- Close all other applications on the computer to ensure reliable CD-R disc recording.

JPEG Files

CD-R and CD-RW with JPEG files. Certain JPEG files, including progressive JPEG files, cannot be read by this unit.

The total number of files and folders on the disc should be less than 650. Make sure that files have the ".jpg" extension. Files without the ".jpg" extension will not be able to be read by the unit --- even though the files are shown as JPEG images on your computer.

Specifications

Power supply:
AC 120V~60Hz

Additional Information

"Blu-ray Disc" and  are trademarks.

VUDU is a trademark of VUDU, Inc.



"BD-Live" and "BD-Live" logo are trademarks of Blu-ray Disc Association.



Manufactured under license from Dolby Laboratories. Dolby and the double-D symbol registered are trademarks of Dolby Laboratories.



HDMI, the HDMI logo and High-Definition Multimedia Interface are trademarks or registered trademarks of HDMI Licensing LLC.



Manufactured under license under U.S. Patent #'s: 5,451,942; 5,956,674; 5,974,380; 5,978,762; 6,487,535 & other U.S. and worldwide patents issued & pending. DTS and the Symbol are registered trademarks & DTS Surround and the DTS logos are trademarks of DTS, Inc. Product includes software. © DTS, Inc. All Rights Reserved.



Java and all Java-based trademarks and logos are trademarks or registered trademarks of Oracle America, Inc. in the U.S. and other countries.

Additional Information

Internet Content and Services Disclaimer

All internet content and services accessible through this device belong to third parties and are protected by copyright, patent, trademark and/or other intellectual property laws. Such internet content and services are provided solely for your personal noncommercial use, and you may not use such content or services in a manner that has not been authorized by the internet content owner or service provider. Without limiting the foregoing, unless expressly authorized by the applicable internet content owners or service providers, you may not modify, copy, republish, upload, post, transmit, translate, sell, create derivative works, exploit, or distribute in any manner or medium any content or services displayed through this device.

THIRD PARTY CONTENT AND SERVICES ARE PROVIDED "AS IS." AVC MULTIMEDIA IS NOT RESPONSIBLE FOR YOUR USE OF THE INTERNET CONTENT AND SERVICES, AND DOES NOT WARRANT SUCH CONTENT OR SERVICES SO PROVIDED, EITHER EXPRESSLY OR IMPLIEDLY. AVC MULTIMEDIA DOES NOT GUARANTEE THE ACCURACY, VALIDITY, TIMELINESS, LEGALITY, OR COMPLETENESS OF ANY INTERNET CONTENT OR SERVICE MADE AVAILABLE THROUGH THIS DEVICE AND, UNDER NO CIRCUMSTANCES, INCLUDING NEGLIGENCE, SHALL AVC MULTIMEDIA BE LIABLE, WHETHER IN CONTRACT OR TORT, FOR ANY DIRECT, INDIRECT, INCIDENTAL, SPECIAL OR CONSEQUENTIAL DAMAGES, ATTORNEY FEES, EXPENSES, OR ANY OTHER DAMAGES ARISING OUT OF, OR IN CONNECTION WITH, ANY INFORMATION CONTAINED IN, OR AS A RESULT OF THE USE OF ANY CONTENT OR SERVICES BY YOU OR ANY THIRD PARTY, EVEN IF ADVISED OF THE POSSIBILITY OF SUCH DAMAGES.

Third party content and services may be terminated or interrupted at any time, and AVC Multimedia makes no representation or warranty that any content or services will remain available for any period of time. Internet content and services are transmitted by third parties by means of networks and transmission facilities over which AVC Multimedia has no control. Without limiting the generality of this disclaimer, AVC Multimedia expressly disclaims any responsibility or liability for any interruption or suspension of any content or services made available through this device.

AVC Multimedia is neither responsible nor liable for customer services related to the internet content and services. Any question or request should be made directly to the respective internet content and services providers.

Limited Warranty

AVC MULTIMEDIA ("AVC") makes the following limited warranty. These limited warranties extend to the original consumer purchaser and is limited to non-commercial user of the product.

One Year Parts & Labor Warranty

AVC products purchased in the United States are warranted to be free from defects in materials or workmanship for a period of one year from the date of their original retail purchase. If the unit fails to conform to this warranty, we will service the product using new or refurbished parts and products, at **AVC's** sole discretion.

During a period of one year from the effective warranty date, **AVC** will provide, when needed, service labor to repair a manufacturing defect at its designated Service Center. To obtain warranty service in the United States, you must first call our **Customer Support Center at 1-877-252-6873, during the hours listed in the box below.** The determination of service will be made by AVC customer support.

PLEASE DO NOT RETURN YOUR UNIT TO AVC WITHOUT PRIOR AUTHORIZATION. New or remanufactured replacements for defective parts or products will be used for repairs by **AVC** at its designated Service Center for one year from the defective warranty date. Such replacement parts or products are warranted for an additional one year from the date of repair or replacement. The Customer will be required to ship the unit to the Service Center indicated at the time Customer Support is contacted to make the necessary repairs. The customer is responsible for all transportation charges to the service facility.

Packaging and Shipping Instruction

When you send the product to the **AVC** service facility you must use the original carton box and packing material or an equivalent as designated by **AVC**.

Your Responsibility

- (1) You must retain your bill of sale to provide proof of purchase.
- (2) These warranties are effective only if the product is purchased and operated in the U.S.A. or Canada.
- (3) Warranties extend only to defects in material or workmanship, and do not extend to any product or parts which have been lost or discarded, or damage to product or parts caused by misuse, accident, improper operation or maintenance, or use in violation of instructions provided with the product, or to product which has been altered or modified without authorization of **AVC**, or to products or parts thereof which have had the serial number removed or changed.

Out of Warranty

In the event your product requires repair after the limited warranty period has expired, please contact our Customer Support Center at **1-877-252-6873** or

www.RCAav.com

Hours: Monday-Thursday: 9am-7pm, Friday: 9am-5pm, Saturday: 9am-NOON Eastern time.

Important:

You are responsible for any transportation, shipping or insurance relative to the return of the product to our Product Returns Center.

Limited Warranty

All warranties implied by state law, including the implied warranties of merchantability and fitness for a particular purpose, are expressly limited to the duration of the limited warranties set forth above. With the exception of any warranties implied by state law as hereby limited, the foregoing warranty is exclusive and in lieu of all other warranties, guarantees, agreements and similar obligations of manufacturer or seller with respect to the repair or replacement of any parts. In no event shall **AVC** be liable for consequential or incidental damages.

No person, agent, distributor, dealer or company is authorized to change, modify or extend the terms of these warranties in any manner whatsoever. The time within action must be commenced to enforce any obligation of **AVC** arising under the warranty or under any statute, or law of the United States or any state thereof, is hereby limited to one year from the date of purchase. This limitation does not apply to implied warranties arising under state law.

This warranty gives you specific legal rights and you may also have other rights, which may vary from state to state. Some states do not allow limitation on how long an implied warranty lasts, when an action may be brought, or the exclusion or limitation of incidental or consequential damages, so the above provisions may not apply to you.

For more information on other products and services, please contact our web site at

www.RCAav.com

Important: Also keep your "Bill of Sale" as proof of purchase.

Model no.	Product name
Type of set
Serial no.	Invoice no.
Date purchased	Dealer name

FOR SERVICE AND REPAIR, PLEASE VISIT **www.RCAav.com**

Specifications and external appearance are subject to change without notice.

Need more help?

Please visit online help at <http://www.RCAav.com>