

Excel 10

W7752D,E,F,G,J AND W7754K,L,M,P FAN COIL UNIT CONTROLLERS LNS PLUG-INS

HONEYWELL EXCEL 5000 OPEN SYSTEM

USER GUIDE

CONTENTS

Introduction 1

- Description of Devices 1
- Products Covered 2
- Organization of Manual 2
- Applicable Literature 2
- Product Names 2
- Control Application 3
- Control Provided 3
 - Setpoints 4
 - Bypass 6
 - LED/LCD 6
 - Energy-Saving Features 6
 - Occupancy Status 7
 - Safety Features 8
 - Operating Modes 8
- Construction 9
 - Excel 10 W7752 FCU Controllers 9
 - Excel 10 W7754 FCU Controllers 9
 - Controller Performance Specifications 11
- Configurations 12
 - General 12
 - Fan Type 12
 - Type of Heating and Cooling Equipment 13
 - Reheat Output 14
 - Digital Input 14
 - Excel 10 Wall Module Options 15
- Abbreviations and Definitions 16

Application Steps 17

- Overview 17
- Step 1. Plan the System 17
- Step 2. Determine Other Bus Devices Required 17
- Step 3. Lay Out Communications and Power Wiring 18
 - LONWORKS Layout 18
 - Power Wiring 19
- Step 4. Prepare Wiring Diagrams 19
 - General Considerations 19
 - Terminal Block Assignment and Wiring Example for the W7752 Controller... 21
 - Terminal Block Assignment and Wiring Example for the W7754 Controller... 22
 - LONWORKS Termination 23
- Step 5. Order Equipment 24
- Step 6. Configure Controllers 25
 - General 25
 - Output 26
 - Input 27
 - Equipment Control 28
 - Fan 28
 - Switching Levels 29
 - Zone Options 29
 - Miscellaneous 29

PID	30
Commissioning	30
ID Number	30
Step 7. Troubleshooting	30
Troubleshooting Excel 10 FCU Controllers and Wall Modules	30
Alarms	30
Broadcasting the Service Message	32
Manual Mode	32
Appendix A: Using An LNS tool to Commission a Fan Coil Unit	33
Temperature Sensor Calibration	33
Appendix B: Configuring for Master/Slave Operation	34
Output Configuration Options	34
Input Configuration Options	34
Equipment Control Options	34
Zone Control Options	34
Network Variable Binding	34
Appendix C: LON Interface	35

Revision History

page no.	change
13	Information on configuration of actuator runtime and on valve synchronization has been added

INTRODUCTION

Description of Devices

The W7752D,E,F,G, and J Controllers and W7754K,L,M,N, and P Controllers are Fan Coil Unit Controllers belonging to the Excel 10 product line. Excel 10 FCU Controller systems control the space temperature in a given room by regulating the heating and/or cooling equipment which control the temperature of the air delivered to that space and the fan which controls air flow. Reheat coils are often included at the fan coil unit. Excel 10 FCU Controllers are capable of stand-alone operation; however, optimum functional benefits are achieved when the network communication capabilities are used.

A family of direct wired wall modules with a temperature sensor for space temperature measurement, setpoint adjustment, bypass push-button, status LED, and LCD display can be used in conjunction with Excel 10 FCU Controllers.

The wall modules are available in a variety of models incorporating various combinations of the following options:

- Setpoint adjustment
- Bypass pushbutton and LED
- Fan Switching
- See Table 7 on page 12 for a complete list of wall modules options

Excel 10 FCU Controllers connect to a LonWorks network and interoperate with 3rd-party nodes.

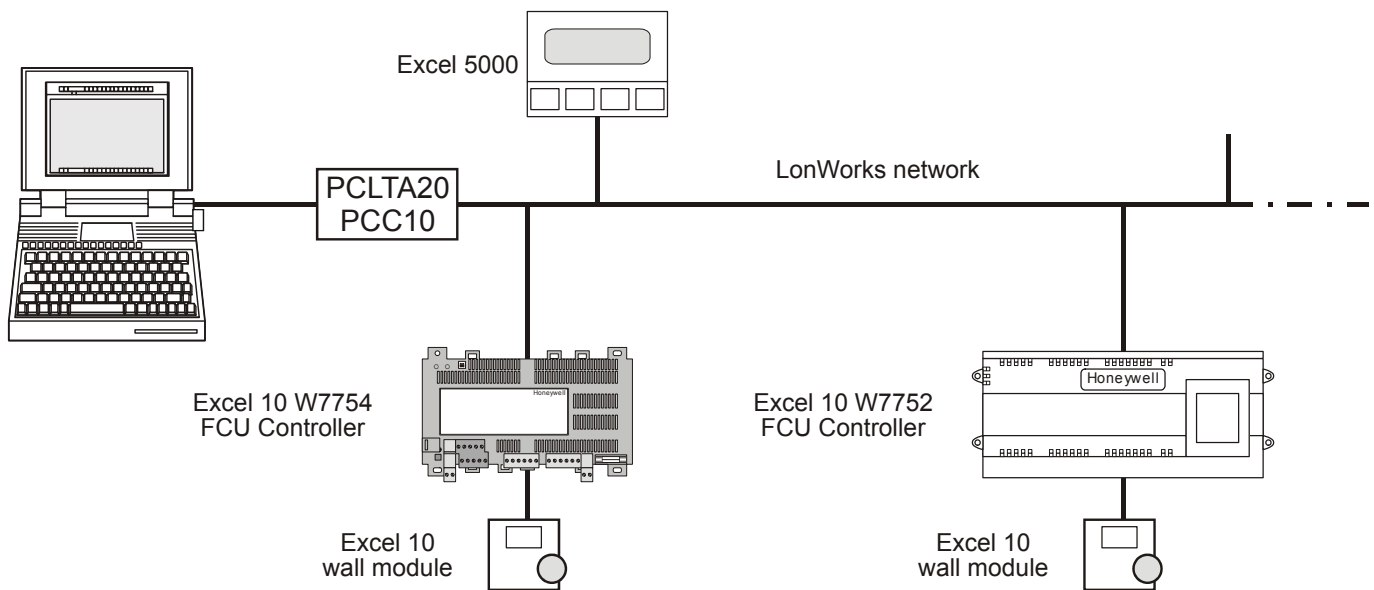

Fig. 1. Typical system overview

Products Covered

This System Engineering Guide describes how to apply the Excel 10 FCU Controllers and the accessories to typical FCU applications. The specific devices covered include:

- W7752D,E,F,G, and J FCU Controllers.
- W7754K,L,M,N, and P FCU Controllers.
- T7460 Wall Modules.
- T7560 Wall Modules.

Organization of Manual

The Introduction and Application Steps 1 through 5 provide the information needed to make accurate ordering decisions. Application Step 6 and the Appendices include configuration engineering that can be started using a LNS tool after the devices and accessories are ordered. Application Step 7 is troubleshooting. Information provided in support of the use of third-party LonWorks communication packages to configure FCU Controllers is found in the Appendices.

The organization of the manual assumes a project is being engineered from start to finish. If you are adding to, or changing an existing system, the Table of Contents can guide you to the relevant information.

Applicable Literature

The following is a list of documents that contains information related to the Excel 10 FCU Controller. **Form No.**

	Title
EN0B-0376GE51	Excel 10 W7752D,E,F,G,J FCU Controller Specification Data
EN0B-0453GE51	Excel 10 W7754K,L,M,N,P FCU Controller Specification Data
EN1B-0250GE51	Excel 10 W7752D,E,F,G,J FCU Controller Installation Instructions
EN1B-0251GE51	Excel 10 W7754K,L,M,N,P FCU Controller Installation Instructions
EN2B-0285GE51	Excel 10 FCU Controller LNS Plug-Ins User Guide
74-3083	Excel 10 T7460 Wall Modules Specification Data
95-7610	Excel 10 T7460 Wall Modules Installation Instructions
EN0B-0237GE51	Excel 10 T7560 Wall Modules Specification Data
EN1B-0146GE51	Excel 10 T7560 Wall Modules Installation Instructions
95-7554	Excel 10 FTT/LPT 209541B Termination Module Installation Instructions

Product Names

The W7752 Controller is available in five models:

- **W7752D** FCU Controller with 230 Vac power supply and with relay suitable for reheat applications.
- **W7752E** FCU Controller with 230 Vac power supply without reheat relay.
- **W7752F** FCU Controller with 115 Vac power supply with reheat relay suitable for reheat applications.
- **W7752G** FCU Controller with 115 Vac power supply without reheat relay.
- **W7752J** FCU Controller with 100 Vac power supply without reheat relay.

The W7754 Controller is available in five models:

- **W7754K** FCU Controller with 230 Vac power supply, one triac output, and one digital output suitable for attachment to a solid-state relay employed for low-voltage Pulse-Width Modulated (PWM) control in high-current electric reheat applications.
- **W7754L** FCU Controller with 24 Vac power supply and two triac outputs.
- **W7754M** FCU Controller with 230 Vac power supply.
- **W7754N** FCU Controller with 230 Vac power supply and two triac outputs.
- **W7754P** FCU Controller with 230 Vac power supply, four triac outputs, and an extra, fourth relay suitable for reheat applications.

The FCU Controllers can use any of the following Excel 10 wall modules:

- **T7460A** with temperature sensor.
- **T7460B** with temperature sensor and setpoint adjustment.
- **T7460C** with temperature sensor, setpoint adjustment, and bypass button and LED.
- **T7460D** with temperature sensor, setpoint adjustment and 5-position fan switch.
- **T7460E** with temperature sensor, setpoint adjustment, bypass button and LED, and 3-position fan switch.
- **T7460F** with temperature sensor, setpoint adjustment, bypass button and LED, and 5-position fan switch.
- **T7560A** with temperature sensor, unit enable button, setpoint adjustment, bypass button, LCD display and configurable fan override with up to five settings.

Other products:

- **C7608A** Return Air Sensor

Refer to the Table 15 (see Application Steps, Step 5. Order Equipment) for complete listing of all available part numbers.

Control Application

Fan coil unit systems in commercial buildings control room temperature through the control of heat and/or cold water valves and fan speed. Electric reheat coils may also be used in the system. The Excel 10 FCU Controller is located in the FCU and is typically connected to an Excel 10 wall module

which incorporates a temperature sensor, setpoint and fan speed controls, and a bypass or override button. Fig. 2 shows a typical FCU control application.

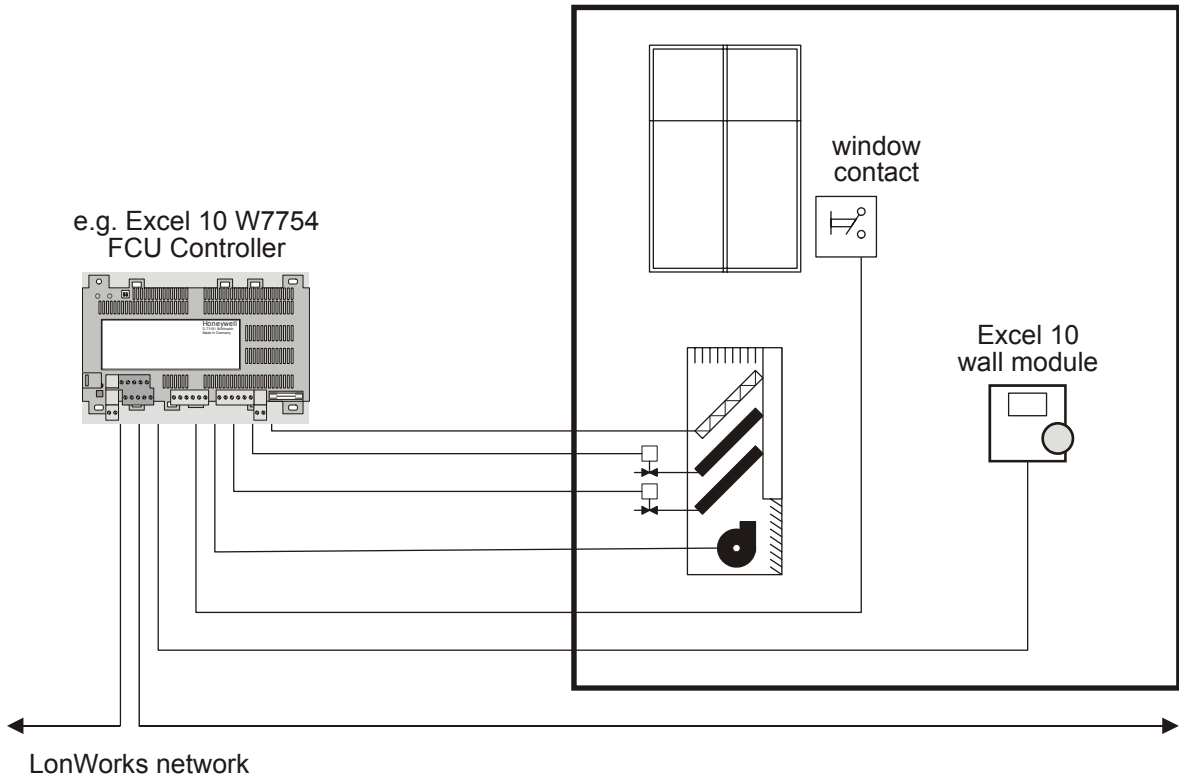

Fig. 2. Typical Fan Coil Unit control application

Control Provided

Excel 10 FCU Controllers provide room temperature control for two- and four-pipe fan coil units with optional electric heating coil. The basic control sequence is shown in Fig. 3. As space temperature falls below the heating setpoint, the heating output is increased. As space temperature increases above the cooling setpoint, the cooling output is modulated to 100%. Switching levels for staged heating/cooling and fan speeds are configurable. The fan may still be configured to run continuously during the zero energy band in the "occupied" mode. Additional configurable fan control features include fan minimum ON/OFF times, run-up, and overrun-times.

Excel 10 FCU Controllers use a PID control algorithm in which each of the three parameters can be configured. There are additional configurable boost parameters ("PID Boost:" "Cooling" and "Heating") which specify a range outside of which the heating or cooling outputs are turned ON fully for faster response (in the case of thermal actuators, this specifies the control hysteresis). The controllers are delivered with factory defaults for each of the parameters.

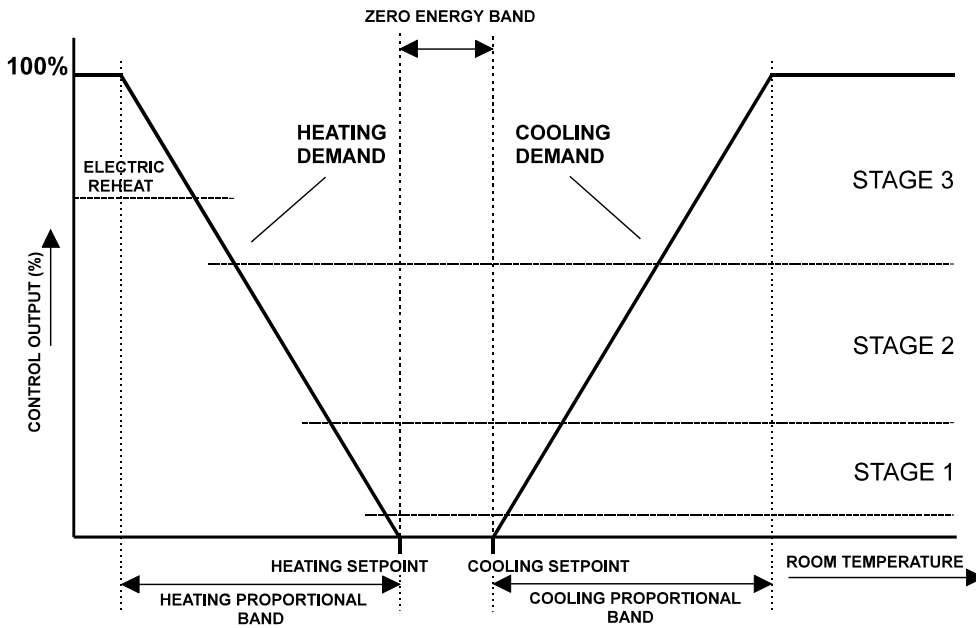

Fig. 3. Control sequence diagram

Setpoints

Setpoint Knob

The Excel 10 FCU Controllers may be hardwired to an Excel 10 wall module equipped with a setpoint knob. When the Excel 10 FCU Controller has been configured (using the LNS plug-in tool) to read input from the wall module's setpoint knob, the value from the setpoint knob is used to calculate the "occupied" setpoint for the heating and the cooling modes. There are two configurations which determine how the setpoint used by the control algorithm is calculated: "relative" (or "offset") and "absolute middle". When configured for "relative", the Excel 10 wall module setpoint knob represents a number from -9...+9 DDF (-5...+5 K) which is added to the configured "occupied" and "standby" setpoints for the heating and the cooling modes. When configured to "absolute middle", the setpoint knob becomes the mid-point of the Zero Energy Band (ZEB) extending between the "occupied" or "standby" setpoints for the heating and the cooling modes. The range of the ZEB is found by taking the difference between the "occupied" or "standby" setpoints configured for the heating and the cooling modes; in the case of "absolute middle", the current "occupied" and "standby" setpoints are therefore found as follows:

When the Excel 10 FCU Controller is in the "occupied" mode:

$$\begin{aligned} \text{nvoActiveSetPt (in cooling mode)} &= \\ &\text{nvoSensor.remote_set_point} + (\text{Cooling Occupied} \\ &\text{Setpoint} - \text{Heating Occupied Setpoint}) / 2 \\ \text{nvoActiveSetPt (in heating mode)} &= \\ &\text{nvoSensor.remote_set_point} - (\text{Cooling Occupied} \\ &\text{Setpoint} - \text{Heating Occupied Setpoint}) / 2 \end{aligned}$$

for Standby:

$$\begin{aligned} \text{nvoActiveSetPt (in cooling mode)} &= \\ &\text{nvoSensor.remote_set_point} + (\text{Cooling Standby} \\ &\text{Setpoint} - \text{Heating Standby Setpoint}) / 2 \\ \text{nvoActiveSetPt (in heating mode)} &= \\ &\text{nvoSensor.remote_set_point} - (\text{Cooling Standby} \\ &\text{Setpoint} - \text{Heating Standby Setpoint}) / 2 \end{aligned}$$

When the Excel 10 FCU Controller is in the "unoccupied" mode, the remote setpoint knob is ignored, and the configured setpoints for this mode are used instead.

Setpoint Limits

Setpoints are limited to the range of 50...95°F (10...35°C). The value of the setpoint knob is limited to the range provided by the configuration parameters Maximum Limit Setpoint pot and Minimum Limit Setpoint pot. In the case of absolute "occupied" and "standby" setpoints, the setpoint knob still represents the mid-point of the ZEB, even when set to either of these limits. The actual setpoints are given by the equations shown above. When the setpoint knob is configured to be "relative", the lowest actual "occupied" setpoint allowed is equal to $\text{SptHeatOcc} - \text{SptKnobLowLim}$, and the highest allowed is equal to $\text{SptCoolOcc} + \text{SptKnobHiLim}$. The lowest and highest "standby" setpoints are found in an analogous fashion.

Setpoint from Network

When the Excel 10 FCU Controller is not configured to be hardwired to a wall module, nviSetPoint must be bound to another node that provides a setpoint. When bound and when a valid update is received, nviSetPoint is used with the appropriate ZEB:

- $\text{ZEBoccupied} = \text{Cooling Occupied Setpoint} - \text{Heating Occupied Setpoint}$
- $\text{ZEBstandby} = \text{Cooling Standby Setpoint} - \text{Heating Standby Setpoint}$

The "unoccupied" setpoint does not depend on nviSetPoint at all.

Setpoint Offset

Third-party nodes may be bound to nviSetPtOffset to shift the setpoint in the range of -18 to 18 DDF (-10 K to 10 K).

Table 1. Example setpoint values based upon default configuration – "absolute middle" setpoint knob (°C)

occupancy mode	configured cooling setpoint	configured heating setpoint	ZEB	setpoint knob ¹	effective cooling setpoint ^{2,3}	effective heating setpoint ^{2,4}
"occupied"	23	21	2	21	22	20
"standby"	25	19	6	21	24	18
"unoccupied"	28	16	12	X	28	16

NOTES:

1. Sample value shown. Limited by default configuration settings to the range of 12...30°C.
2. Limited to the range of 10...35°C.
3. = setpoint knob + (ZEB/2)
4. = setpoint knob – (ZEB/2)

Table 2. Example setpoint values based upon default configuration - Relative setpoint knob (°C)

occupancy mode	configured cooling setpoint	configured heating setpoint	ZEB	setpoint knob ¹	effective cooling setpoint ^{2,3}	effective heating setpoint ^{2,4}
"occupied"	23	21	2	-2	21	19
"standby"	25	19	6	-2	23	17
"unoccupied"	28	16	12	X	28	16

NOTES:

1. Sample value shown. Limited by default configuration settings to the range of -5...+5°C.
2. Limited to the range of 10...35°C.
3. = configured cooling setpoint + setpoint knob
4. = configured heating setpoint + setpoint knob

Bypass

Bypass Mode

When the Excel 10 FCU Controller is in the "unoccupied" mode, the Excel 10 wall module's bypass push-button may be used to force the Excel 10 FCU Controller into the "occupied" mode. The Excel 10 FCU Controller can also be forced into the "occupied" mode by means of a LONWORKS network command (when nviManOccCmd is set to OC_BYPASS). The controller will then remain in "bypass" mode until:

1. The bypass timer has timed out, or
2. The user again presses the Excel 10 wall module's bypass push-button, thus cancelling the "bypass" mode, or
3. The occupancy schedule (nviTodEvent) switches the mode to "occupied".
4. nviManOccCmd is set to OC_NUL.

The Excel 10 wall module indicates the current bypass mode status (see Excel 10 wall module literature for further information).

Bypass Timer

When the "bypass" mode has been activated, the bypass timer is set to BypTime (default of 180 minutes), at the end of which the mode will revert to its original state (see Excel 10 wall module literature for further information).

Continuous "Unoccupied" Mode

The continuous "unoccupied" mode is entered when an Excel 10 wall module is configured to allow it and if:

- (in the case of the T7460) the bypass button is pressed for four to seven seconds (until the LED blinks),
- (in the case of the T7560) the bypass button is pressed for more than five seconds (until the flashing moon appears).

The Excel 10 FCU Controller can also be forced into the continuous "unoccupied" mode by means of a LONWORKS network command (when nviManOccCmd is set to OC_UNOCCUPIED). The Excel 10 FCU Controller will then remain in this mode indefinitely, or until the bypass button is pressed to exit the mode or a network command is sent to clear the mode.

Bypass Push-Button

Excel 10 FCU Controllers may be hardwired to an Excel 10 wall module equipped with a bypass push-button. The bypass push-button has three possible configurations (see Table 17 for further information):

- NONE
- BYPASS_UNOCCUPIED
- BYPASS_ONLY

Override Priority

Excel 10 FCU Controllers can be configured to arbitrate overrides coming from the bypass push-button and the network. There are two possible configurations, having the following meanings:

- LAST_WINS specifies that the last command received from either the wall module or nviManOccCmd determines the effective override state.
- NETWORK_WINS specifies that, regardless of the wall module override state, the effective occupancy mode is

determined by nviManOccCmd (provided it has not been set to OC_NUL).

LED/LCD

LED Override

The wall module's LED indicates that the FCU Controller is being overridden by either the bypass button or the LONWORKS network.

- LED ON ⇒ "override bypass"
- One flash per second ⇒ "override unoccupied"
- Two flashes per second ⇒ "override standby" or "occupied"
- LED OFF ⇒ no override
- Four flashes per second ⇒ The controller is responding to a LONWORKS network management wink command.





LED Occupancy

The wall module's LED indicates the effective occupancy mode.





- LED ON ⇒ effective "occupied" or effective "bypass"
- One flash per second ⇒ effective "standby"
- LED OFF ⇒ effective "unoccupied"
- Four flashes per second ⇒ The controller is responding to a LONWORKS network management wink command.

LCD Display

This mode is used only for T7560 Wall Modules. The occupancy mode is represented by the following symbols:

-  ⇒ effective "occupied" or effective "bypass"
-  ⇒ effective "standby"
-  ⇒ effective "unoccupied"
- OFF ⇒ Controller is OFF
- OFF and  ⇒ Controller is OFF, frost protection is enabled.

Flashing symbols indicate the "override" mode:

-  ⇒ override "occupied" or override "bypass"
-  ⇒ override "standby"
-  ⇒ override "unoccupied"
-  ⇒ The controller is responding to a LONWORKS network management wink command.

Energy-Saving Features

The "Standby" Mode

The digital input for reading input from an occupancy sensor (usually a motion detector) provides the Excel 10 FCU Controller with a means to enter an energy-saving standby mode whenever there are no people in the room. The "standby" mode occurs when the scheduled occupancy mode is "occupied" but the occupancy sensor indicates that the room is nevertheless currently unoccupied. If no occupancy sensor is directly connected to the Excel 10 FCU Controller, an occupancy sensor from another node may be bound to the network input nviSensorOCC. The Excel 10 FCU Controller can also be forced into the "standby" mode by means of a LONWORKS network command (when nviManOccCmd is set to OC_STANDBY). When in the "standby" mode, the Excel 10 FCU Controller uses the "standby" setpoints configured for the heating and the cooling modes.

Window Sensor

The digital input for reading input from a window contact provides the Excel 10 FCU Controller with a means to disable its temperature control activities if someone has opened a window or door in the room. If no window sensor is directly connected to the Excel 10 FCU Controller, the sensor from another node may be used by binding it to nviWindow. Frost protection remains active. Normal temperature control resumes when the window closes.

Demand Limit Control

When a high-electrical-demand signal is received from an energy management system via the LONWORKS network (nviDlcShed), the Excel 10 FCU Controller uses Demand Limit Control Bump to shift the current setpoint (down for heating and up for cooling) by the configured value to save energy.

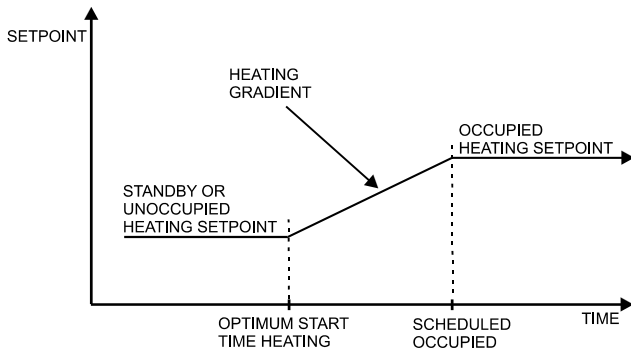

Fig. 4. Optimum start - heating

Optimum Start Gradients

There are two parameters, Cool Rec Ramp and Heat Rec Ramp, which can be configured to cause the cooling and heating setpoints respectively to ramp up to their occupied settings from their unoccupied or standby settings prior to scheduled occupancy. The Excel 10 FCU Controller uses the configured rates to determine the optimum time to start increasing the heating or cooling demand. See the following figures. The configuration parameters are in K/hour.

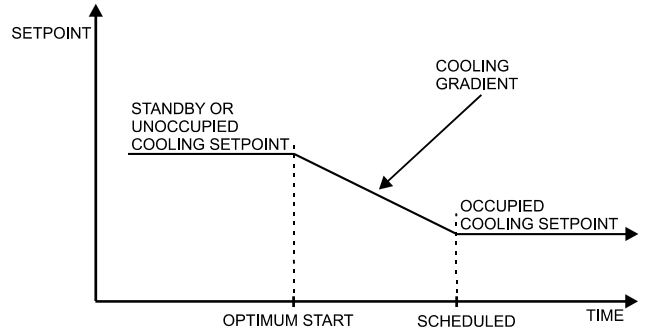

Fig. 5. Optimum start - cooling

Occupancy Status

The occupancy status is determined based upon the following table. Manual override may come from nviManOccCmd or from the bypass push-button.

Table 3. Effective occupancy mode arbitration

scheduled occupancy mode	occupancy sensor status	manual override status	effective operating mode
"occupied"	room occupied	not assigned	OC_OCCUPIED
"occupied"	room not occupied	not assigned	OC_STANDBY
X	X	"occupied"	OC_OCCUPIED
X	X	"unoccupied"	OC_UNOCCUPIED
X	X	"standby"	OC_STANDBY
"occupied"	X	"standby"	OC_OCCUPIED
"standby"	X	not assigned	OC_STANDBY
"standby"	X	"standby"	OC_OCCUPIED
"unoccupied"	X	not assigned	OC_UNOCCUPIED
"unoccupied"	X	"standby"	OC_BYPASS
X=Don't care			

Safety Features

Frost Protection

If the room temperature falls below 46.4 °F (8 °C), the Excel 10 FCU Controller enables the heating circuit to ensure frost protection and an alarm is issued. When the temperature rises above 48.2 °F (9 °C) again, the heating circuit is turned OFF again.

Smoke Control

The Excel 10 FCU Controller will respond to LONWORKS network emergency commands by switching OFF heating/cooling outputs and switching OFF the fan (depressurize) or switching ON the fan at its highest speed (pressurize). An alarm is issued for any emergency commands

Fan Failure Protection

When configured with an airflow detector, the Excel 10 FCU Controller protects equipment by switching OFF heating / cooling outputs and issuing an alarm when the fan fails.

Fan Interlocks

The Excel 10 FCU Controller can be configured such that heating and/or cooling outputs are never ON unless the fan is running. A fan run-up time can be configured to turn ON the fan prior to the heating/cooling outputs being switched ON, and a fan overrun time can be configured to keep the fan running for a period of time after the heating/cooling outputs are switched OFF.

Operating Modes

The possible modes of operation are listed in Table 4.

Table 4. Modes of operation for Excel 10 FCU Controller

mode	description	events causing a transition to this mode
operational modes (NV reference)		
START-UP AND WAIT	Control algorithms are disabled. Outputs stay in their initial positions. Physical inputs are periodically read and digital filtering of analog inputs is turned OFF to speed up settling time. Input NVs are received and output NVs are sent periodically.	This is the first mode after an application restart.
FLOATING OUTPUTS SYNCH	The Excel 10 FCU Controller drives the floating control valves to their initial positions and then transitions to one of the control modes.	When the effective occupancy changes to "unoccupied" or "standby", after start-up, after 24 hours since the last positioning, or after each positioning to 0%, the Excel 10 FCU Controller transitions to this mode.
COOLING	The Excel 10 FCU Controller is controlling in the cooling mode.	Network input nviApplicMode has a value of HVAC_COOL or HVAC_AUTO and the space temperature is above the cooling setpoint.
HEATING	The Excel 10 FCU Controller is controlling in the heating mode.	Network input nviApplicMode has the value of HVAC_HEAT or HVAC_AUTO and the space temperature is below the heating setpoint.
MANUAL MODE	The control algorithms stay active and outputs are controlled automatically until set individually to test positions using the input NV nviTest.	Network input nviManualMode has value of MODE_MANUAL.
FACTORY TEST	Control algorithm is disabled; a special factory test program runs.	This mode is for factory testing, only.
DISABLED	Control algorithms are terminated, outputs are turned OFF (turn-OFF sequences and interlocks are active). Frost protection is disabled.	Network input nviManualMode has a value of MODE_DISABLED.
PRESSURIZE	Heating/cooling outputs are switched OFF, and the fan is switched ON at its highest speed.	Network input nviEmerg containing smoke control signal from the LONWORKS network has the value of EMERG_PRESSURIZE.
DEPRESSURIZE	Heating, cooling, and fan outputs are switched OFF.	Network input nviEmerg containing smoke control signal from the LONWORKS network has the value of EMERG_DEPRESSURIZE.

Construction

Excel 10 W7752 FCU Controllers

The Excel 10 W7752 FCU Controller is available in five basic models, each with two different possibilities for LONWORKS transceivers. All of these controllers are mains-powered, and two models are equipped with an additional high-power relay for applications with electric reheat. Table 5 shows the differences between models.

Table 5. Excel 10 W7752 FCU Controller models

OS number	power input	reheat relay
W7752D2007	230 Vac	X
W7752E2004	230 Vac	
W7752F2002	115 Vac	X
W7752G2000	115 Vac	
W7752J2003	100 Vac	

All wiring connections to the controllers are made at screw terminal blocks accessible beneath a plastic safety cover. Mounting dimensions are shown in Fig. 6 on page 10.

Excel 10 W7754 FCU Controllers

The Excel 10 W7754 FCU Controller is available in five basic models, each with two different possibilities for LONWORKS transceivers. Table 6 shows the differences between models.

Table 6. Excel 10 W7754 FCU Controller models

OS number	power input	reheat relay
W7754K1001	230 Vac	
W7754L1009	24 Vac	
W7754M1007	230 Vac	
W7754N1004	230 Vac	
W7754P1000	230 Vac	X

All wiring connections to the controllers are made at screw terminal blocks accessible beneath a plastic safety cover. Mounting dimensions are shown in Fig. 7 on page 10.



CAUTION

If Excel 10 FCU Controllers are mounted vertically and thermal actuators are used, the transformer must not be located below the electronics due to heating effects.



WARNING

Electrical Shock Hazard.

Mains power at terminal block can cause personal injury or death. Excel 10 FCU Controllers must be mounted inside their fan coil unit boxes to prevent access by unauthorized personnel.

To reduce the risk of fire or electric shock, install in a controlled environment relatively free of contaminants.

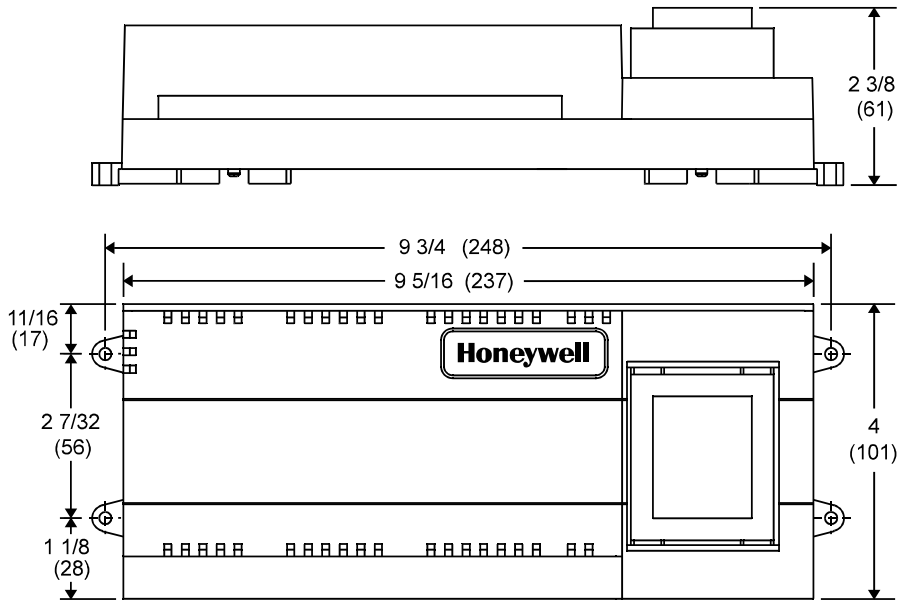

Fig. 6. W7752 dimensions, in inches (mm)

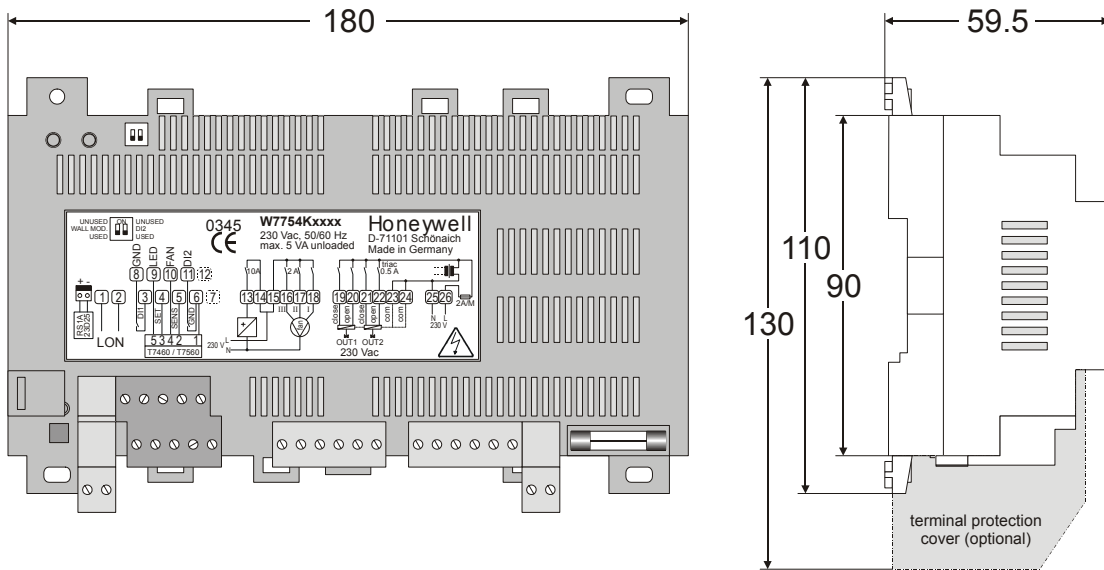

Fig. 7. W7754 dimensions, in mm

Controller Performance Specifications

Power:

W7752D and W7752E; W7754K,M,N,P
 230 Vac +10%, -15%, 50/60 Hz.

W7752F and W7752G
 115 Vac +10%, -15%, 50/60 Hz.

W7752J
 100 Vac ±6%, 50/60 Hz.

W7754L
 24 Vac ±20%, 50/60 Hz.

Operating Temperature:
 32...122°F (0...50°C).

Shipping/Storage Temperature:
 -40...+158°F (-40...+70°C).

Relative Humidity:
 5% to 95% non-condensing

Inputs:

Temperature Sensor:
 20k ohm NTC

Setpoint Potentiometer:
 10k ohm

Digital Input:
 Closed ≤ 400 ohms
 Open ≥ 10 K ohms

Outputs:

Triac voltage range:
 24 Vac ± 20%.
 Triac max. current ratings:
 250 mA continuous
 650 mA surge for 30 sec.

IMPORTANT:

When any device is energized by a triac, the device must be able to sink a minimum of 15 mA. If non-Honeywell motors, actuators, or transducers are to be used with Excel 10 FCU Controllers, compatibility must be verified.

Fan relays voltage range:
 20 to 253 Vac
 Fan relays max. current rating:
 3 A

Electric reheat relay voltage range:
 20 to 253 Vac
 Electric reheat relay max. current rating:
 10 A
 6 A (UL916)

Interoperability

The Excel 10 FCU Controllers use the LonTalk protocol. They support the LONMARK Functional Profile # 8020 "Fan Coil Unit Controller", version 2.0. Fig. 8 shows the implementation used.

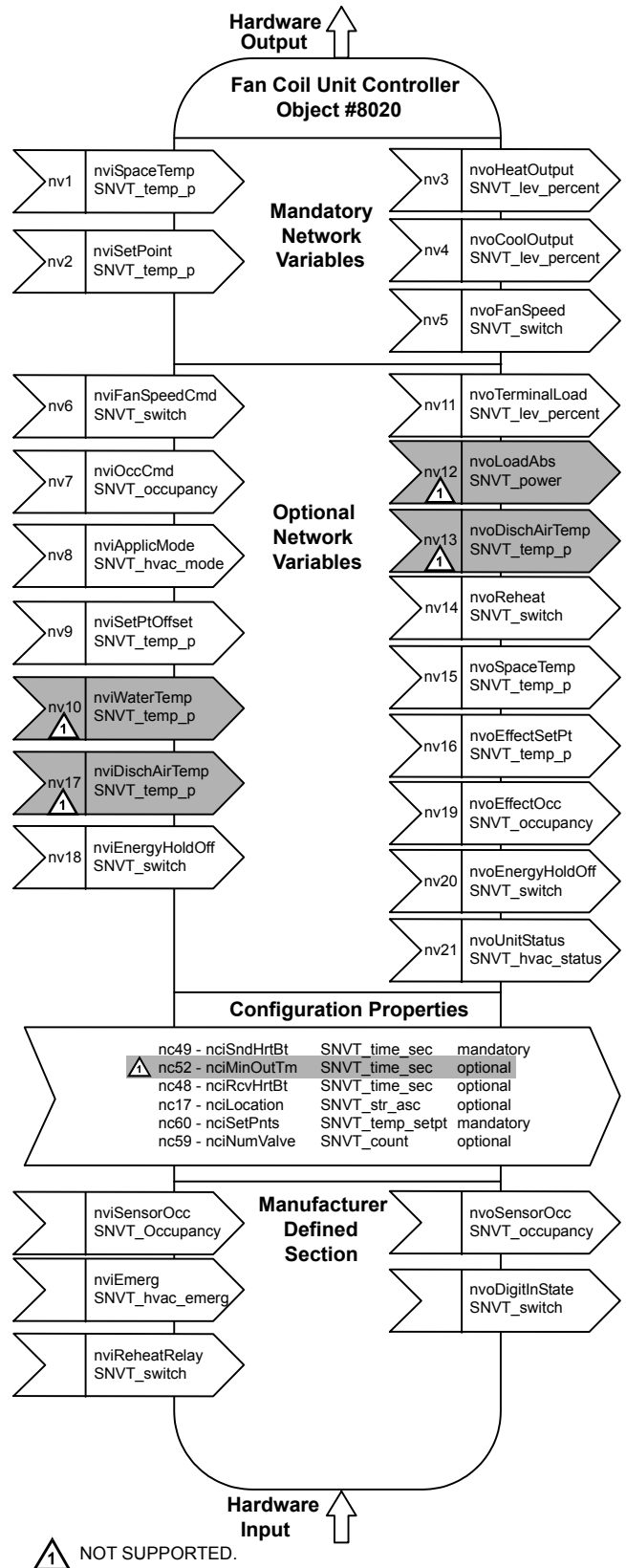

Fig. 8. LONMARK FCU object profile

Configurations

General

The following sections provide an overview of the Excel 10 FCU Controller options related to inputs and outputs. See Application Step 6. Plug-Ins Configuration Screens for complete list of configuration options and defaults.

Table 7. Hardware options summary

option	possible configurations
fan type	<ul style="list-style-type: none"> no fan one-speed two-speed three-speed
fan interlock	<ul style="list-style-type: none"> enabled disabled
FCU system type	<ul style="list-style-type: none"> two-pipe four-pipe
output 1 actuator type	<ul style="list-style-type: none"> floating floating mid (one for heat/cool)¹ one-stage two-stage three-stage PWM thermal
output 2 actuator type	<ul style="list-style-type: none"> floating floating mid (one for heat/cool)¹ one-stage two-stage three-stage PWM thermal
valve direction	<ul style="list-style-type: none"> direct reverse
reheat	<ul style="list-style-type: none"> none reheat (W7752D and F and W7754P1000, only) free use (W7752D and F and W7754P1000, only)
digital input	<ul style="list-style-type: none"> not used window closed occupied sensor air flow detector cool changeover window open unoccupied sensor no air flow heat changeover movement no movement
wall module option	<ul style="list-style-type: none"> local shared
temperature sensor type	<ul style="list-style-type: none"> none NTC non-linearized

NOTE:

¹ The floating-mid option is only for changeover applications and uses only one of the two outputs.

Fan Type

Each fan coil unit controlled by an Excel 10 FCU Controller can have a fan with up to three different speeds or no fan at all. Multi-speed fans are switched at the same switching levels as multi-staged heating control points (see Fig. 9). For example, a three-speed fan will switch ON its first speed at the same control level as the first stage of heating or cooling up until the second stage of heating or cooling where the second fan speed will switch on. A two stage fan will switch with the first two stages of a 3-stage heating or cooling system. Likewise, a single speed fan will turn ON at the first stage of any multi-staged system. Conversely, a multi-speed fan may follow multiple switching levels even for single-staged, floating, PWM, or thermal actuator-based systems.

Hysteresis

The hysteresis for fan speed extends to the next lower switching level (or a control level of 0) as is shown in Fig. 9. For example, the second fan speed will remain ON until the control level falls below the switching point for the first fan speed. Minimum ON/OFF times can be configured and will apply to all fan switching points.

Interlock

A fan interlock can be configured which prevents heating or cooling outputs from being turned ON in the event of a fan failure (where an air flow detector is installed to detect fan failure). When fan interlock is configured, run-up and overrun-times can be configured to delay switching ON the heating or cooling equipment after switching ON the fan and delay switching OFF the fan after the heating or cooling equipment is switched OFF.

The fan can be configured to run continuously during the zero energy band during occupied periods.

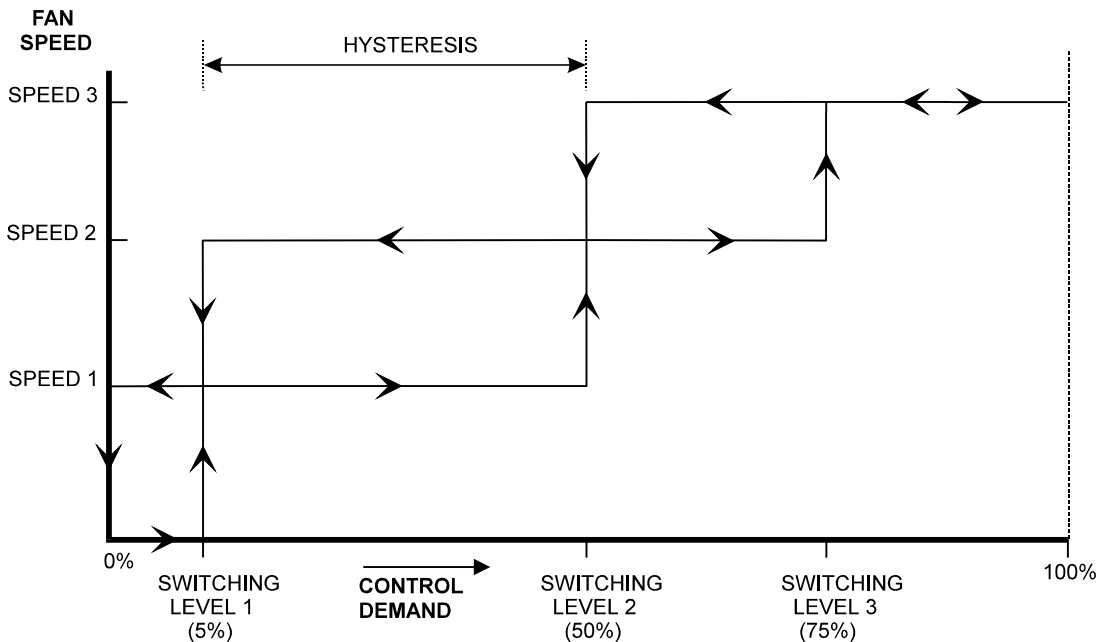

Fig. 9. Three-speed fan switching and hysteresis, cooling mode (defaults for switching levels shown)

Type of Heating and Cooling Equipment

Excel 10 FCU Controllers can operate with either two-pipe or four-pipe systems. A two-pipe system requires a changeover input to the controller (hardware or network input).

Excel 10 FCU Controllers can operate with a variety of actuators for heating and cooling equipment. Floating actuators can be used; this requires that the valve run time be specified during configuration of the controller.

The actuator runtimes can be configured in the range 20 sec to 600 sec in steps of 1 second.

Valves will be synchronized by driving the valve fully closed (150% of the valve run time) under the following conditions:

- whenever the control level reaches 0% or less;
- at power-on;
- whenever the occupancy status changes to a lower mode, e.g., from occupied to standby or unoccupied;
- when synchronization has not taken place within the last 24 hours.

Once synchronization has been completed, the output control will be returned to the normal control loop.

Valve action can be configured as either direct or reverse. When in a two-pipe system with a changeover input, a floating actuator can be used which has the middle position (50%) as the zero energy position. The cool range is then 0 to 50% and the heat range 50 to 100%. The output must be configured as floating-mid.

Multi-stage systems can be controlled with up to three different stages of heating/cooling control. Switching levels are specified in % of control level (see Fig. 10) as is a hysteresis setting which applies to all switching levels. Heating and cooling switching levels and hysteresis are specified separately. Min. OFF times can be configured, and for one-, two- and three-stage systems, a min. ON time can also be configured.

PWM electronic valves and thermal actuators can also be connected and can be configured as either direct or reverse action. The cycle time must be specified during configuration. In the case of PWM valves, the zero and full positions must also be configured.

Additionally, the W7754K1001 features an extra socket (located to the left of the terminal blocks) containing a digital output suitable for connection to a solid-state relay employed for low-voltage PWM control in high-current electric reheat applications.

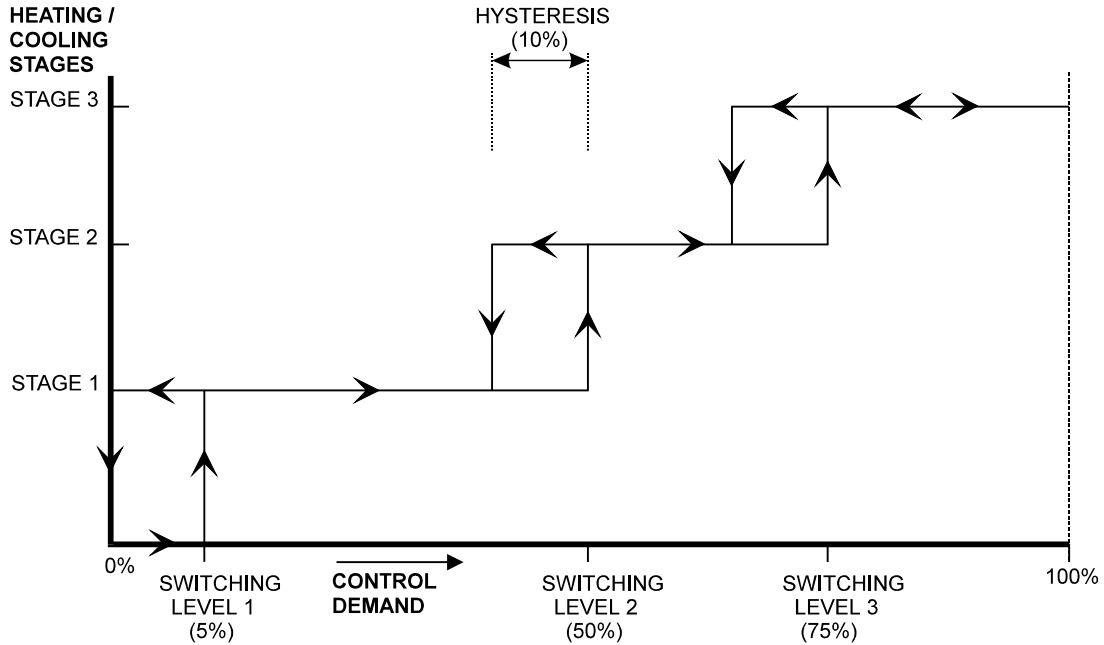

Fig. 10. Three-stage heating/cooling switching (defaults for switching levels and hysteresis shown)

Reheat Output

W7752D and F Controllers and the W7754P1000 have an additional high-current (10 A max.; UL916: 6 A max.) output relay to control an electric reheater (refer to Fig. 2 for sample application). The reheat output has its own switching level and hysteresis settings (see Fig. 11). The reheat relay may also be used as an auxiliary output for other purposes, in which case the controller must be configured to specify that the output is under network control instead of the FCU control algorithm.

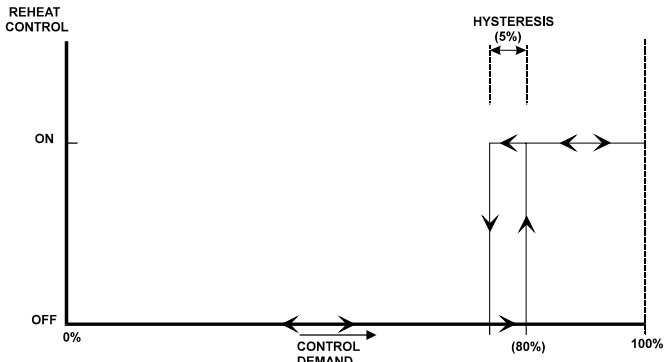

Fig. 11. Reheat switching and hysteresis (defaults shown)

Digital Input

The Excel 10 W7752 FCU Controllers are equipped with a single digital input which may be configured to accommodate an occupancy sensor, a window open/closed contact, an air flow detector (for fan failure detection), or a changeover input. It is possible to configure this input for either normally-open or normally-closed contacts for any of the switches.

The control algorithm in the Excel 10 FCU Controller uses the occupancy sensor, if configured, to determine the effective occupancy mode (see Table 3). If the Time Of Day (TOD) schedule indicates an occupied state, and the occupancy

sensor contact is closed, the effective occupancy mode will be "occupied". However, if the TOD schedule indicates an occupied state and if the occupancy sensor contact is open, then the effective occupancy mode will be "standby". The control algorithm will then control according to the "standby" setpoints configured for the heating and the cooling modes.

Configuring the digital input for movement or no movement (dependent upon normally-open or normally-closed contacts) adds a delay of 15 minutes to the occupancy sensor such that the space is considered occupied until 15 minutes has elapsed since the last movement is detected.

If the digital input is configured to read input from a window open/closed contact, heating, cooling, and fan control will be disabled while the window is detected open. Frost protection will be enabled. A set of contacts may be wired in series for multiple windows. If the window open/closed contact is not configured, a one-to-one association (binding) of the window sensor from another controller on the LONWORKS network can be made. A locally-wired contact can also be used in combination with the network input, the result being a logical OR of the inputs.

If the digital input is configured to read input from an air flow detector (fan status), heating and cooling control will be disabled for a fan failure (fan ON and no air flow detected).

The input may also be configured for changeover for a two-pipe system.

The Excel 10 W7754 FCU Controllers are equipped with a second digital input which is permanently assigned (i.e. not configurable using the plug-in) to the window contact function.

Excel 10 Wall Module Options

A typical FCU installation will include an Excel 10 wall module containing a 20k ohm NTC room temperature sensor and additional features depending on the wall module type (see Excel 10 wall module literature for further information).

Excel 10 FCU Controllers can use a return air sensor rather than the sensor in the wall module if it is wired to the wall module sensor input. Setpoint adjustments can be configured as relative or absolute, and upper and lower limits can be set. A configuration option for the fan speed switch allows it to be disabled if not required. The bypass button can be configured to override the control mode to "occupied" for a configurable bypass time and to override the control mode to "unoccupied" for an indefinite time, or it may be configured to only override to "occupied". The button may also be used to cancel the override.

Common Temperature Control (Master/Slave Controllers)

When one or more Excel 10 FCU Controllers serve a common area and a single temperature sensor is to be used, a master/slave arrangement can be configured. One Excel 10 FCU Controller is configured for the local wall module with the desired options. The other Excel 10 FCU Controller(s) will be configured without wall modules and with certain network variables bound with the master controller. Refer to Application Step 6 of this document for more details.

IMPORTANT

The slave units must have the same HVAC equipment connected to it as the master units.

The slave units will not use any internal temperature setpoints or control algorithms. The master controller determines heating/cooling output based upon setpoints and occupancy and LONWORKS network command mode status and communicates this to the slave via the LONWORKS network.

Abbreviations and Definitions

CARE	Computer Aided Regulation Engineering; the PC based tool used to configure LonWorks devices.	LONWORKS	Echelon® LONWORKS® network for communication among Excel 10 FCU Controllers.
CPU	Central Processing Unit; an EXCEL 5000® System controller module.	NEC	National Electrical Code; the body of standards for safe field-wiring practices.
Echelon®	The company that developed the LONWORKS® network and the Neuron® chips used to communicate on it.	NEMA	National Electrical Manufacturers Association; the standards developed by an organization of companies for safe field wiring practices.
EMI	Electromagnetic Interference; electrical noise that can cause problems with communications signals.	NV	Network Variable; an Excel 10 FCU Controller parameter that can be viewed or modified over the LONWORKS network.
EMS	Energy Management System; refers to the controllers and algorithms responsible for calculating optimum operational parameters for max. energy savings in the building.	OEM	Original Equipment Manufacturer; the company that builds the fan coil units.
EEPROM	Electrically Erasable Programmable Read Only Memory; the variable storage area for saving user setpoint values and factory calibration information.	PC	Personal Computer.
EPROM	Erasable Programmable Read Only Memory; the firmware that contains the control algorithms for the Excel 10 FCU Controller.	Pot	Potentiometer. A variable resistance electronic component located on Excel 10 wall modules. Used to allow user-adjusted Setpoints to be inputted into the Excel 10 FCU Controller.
Firmware	Software stored in a nonvolatile memory medium such as an EPROM.	segment	A LONWORKS section containing no more than 60 Excel 10s. Two segments can be joined together using a router.
I/O	Input/Output; the physical sensors and actuators connected to a controller.	Subnet	An LONWORKS segment that is separated by a router from its Q7750A Zone Manager.
I x R	I times R or current times resistance; refers to Ohms Law: $V = I \times R$.	TOD	Time-Of-Day; the scheduling of Occupied and Unoccupied times of operation.
K	Kelvin.	VA	Volt Amperes; a measure of electrical power output or consumption as applicable to an ac device.
		Vac	Voltage alternating current; ac voltage as opposed to dc voltage.

APPLICATION STEPS

Overview

Steps one through seven (see Table 8) address considerations for engineering an Excel 10 FCU System. These steps are guidelines intended to aid understanding of the product I/O options, bus arrangement choices, configuration options and the Excel 10 FCU Controllers' role in the overall EXCEL 5000® System architecture.

Table 8. Application steps

Step No.	Description
1	Plan the System
2	Determine Other Bus Devices Required
3	Lay Out Communication and Power Wiring
4	Prepare Wiring Diagrams
5	Order Equipment
6	Configure Controllers
7	Troubleshooting

Step 1. Plan the System

Plan the use of the FCU Controllers according to the job requirements. Determine the location, functionality and sensor or actuator usage. Verify the sales estimate of the number of FCU Controllers and wall modules required for each model type. Also check the number and type of output actuators and other accessories required.

When planning the system layout, consider potential expansion possibilities to allow for future growth. Planning is very important to be prepared for adding HVAC systems and controllers in future projects.

notebook PC using an LNS tool

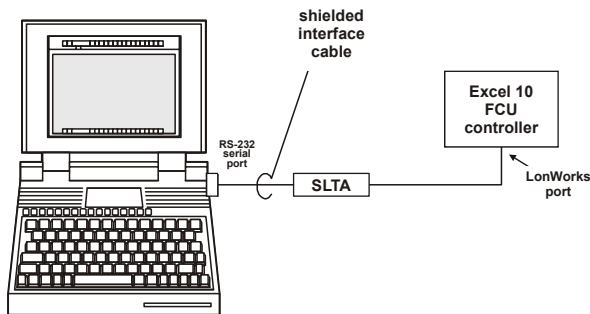

Fig. 12. Connecting the portable operator terminal to the LonWORKS network

The LonWORKS communication loop between controllers must be laid out according to the guidelines applicable for that topology. FCU Controllers use FTT technology which allows daisy chain, star, loop or combinations of these bus configurations. See section "Step 3. Lay Out Communications and Power Wiring" (page 18) for more information on bus wiring layout, and see Fig. 13, Fig. 14, and Fig. 15 in section "Step 4. Prepare Wiring Diagrams" (page 19) for wiring details.

It is important to understand the interrelationships between FCU Controllers on the LonWORKS network early in the job

engineering process to ensure their implementation when configuring the controllers. (See section "Step 6. Configure Controllers" [page 25] for information on the various Excel 10 FCU Controller parameters and on Excel 10 FCU Controller point mapping.)

Step 2. Determine Other Bus Devices Required

A max. of 62 nodes can communicate on a single LonWORKS segment. If more nodes are required, a router is necessary. Using a router allows up to 125 nodes, divided between two LonWORKS segments. The router accounts for two of these nodes (one node on each side of the router). Table 9 summarizes the LonWORKS segment configuration rules.

Table 9. LonWORKS configuration rules and number of device nodes

One LonWORKS Segment (Example)	Max. No. of Nodes = 62
Max. no. of Excel 10 Controllers	60 nodes (T7460/T7560 wall modules are not LonWORKS nodes)
Total	62 nodes
Two LonWORKS Segments (Example)	Max. No. of Nodes = 125
Max. no. of Excel 10 Controllers in segment number one	60 nodes (T7460/T7560 wall modules are not LonWORKS nodes)
Max. no. of Excel 10 Controllers in segment number two	60 nodes (T7460/T7560 wall modules are not LonWORKS nodes)
Total	125 nodes

The max. length of an FTT LonWORKS segment is 4600 ft (1400 m) for a daisy chain configuration or 1650 ft (500 m) total wire length and (400 m) node-to-node for any other type of configuration.

NOTE: In the case of FTT LonWORKS segments, the distance from each transceiver to all other transceivers and to the termination must not exceed the max. node-to-node distance. If multiple paths exist, the longest one should be used for the calculation.

If longer runs are required, add a router in order to partition the system into two segments.

In addition, all LonWORKS segments require the installation of a Bus Termination Module. For an FTT LonWORKS segment, one or two Termination Modules may be required depending upon the bus configuration. See section "Step 3. Lay Out Communications and Power Wiring" (page 18) and the LonWORKS Termination Module subsection in section "Step 4. Prepare Wiring Diagrams" (page 19) for more details.

Step 3. Lay Out Communications and Power Wiring

LONWORKS Layout

The communications bus, LONWORKS, is a 78-kilobit serial link that uses transformer isolation and differential Manchester encoding. Wire the LONWORKS using wires with specifications set forth in Table 10. An FTT LONWORKS can be wired in daisy chain, star, loop or any combination thereof as long as the max. wire length requirements given in Step 2 are met.

NOTE: Due to the transformer isolation, the bus wiring does not have a polarity; that is, it is not important which of the two LONWORKS terminals are connected to each wire of the twisted pair.

LONWORKS networks can be configured in a variety of ways, but the rules listed in Table 9 always apply. Fig. 13 and Fig. 14 depict two typical daisy chain LONWORKS network layouts; one as a single bus segment that has 60 nodes or less, and one showing two segments. Fig. 15 shows examples of free topology bus layouts. The bus configuration is set up using the Network Manager tool.

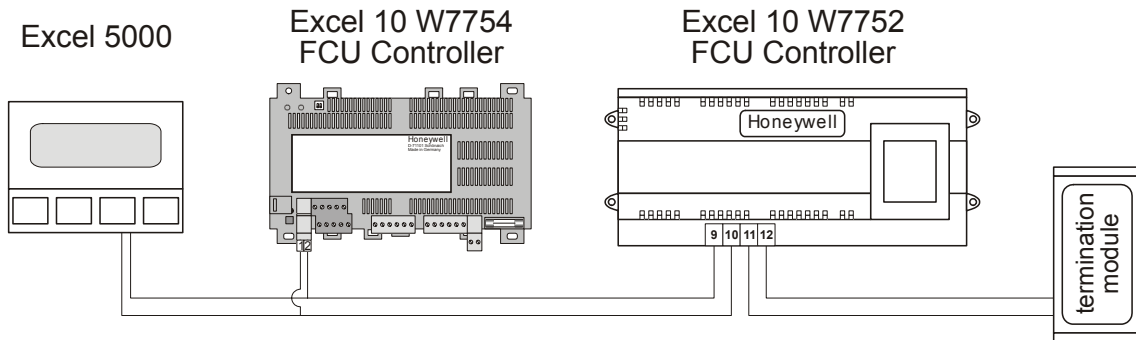

Fig. 13. LONWORKS wiring layout for one daisy-chain network segment

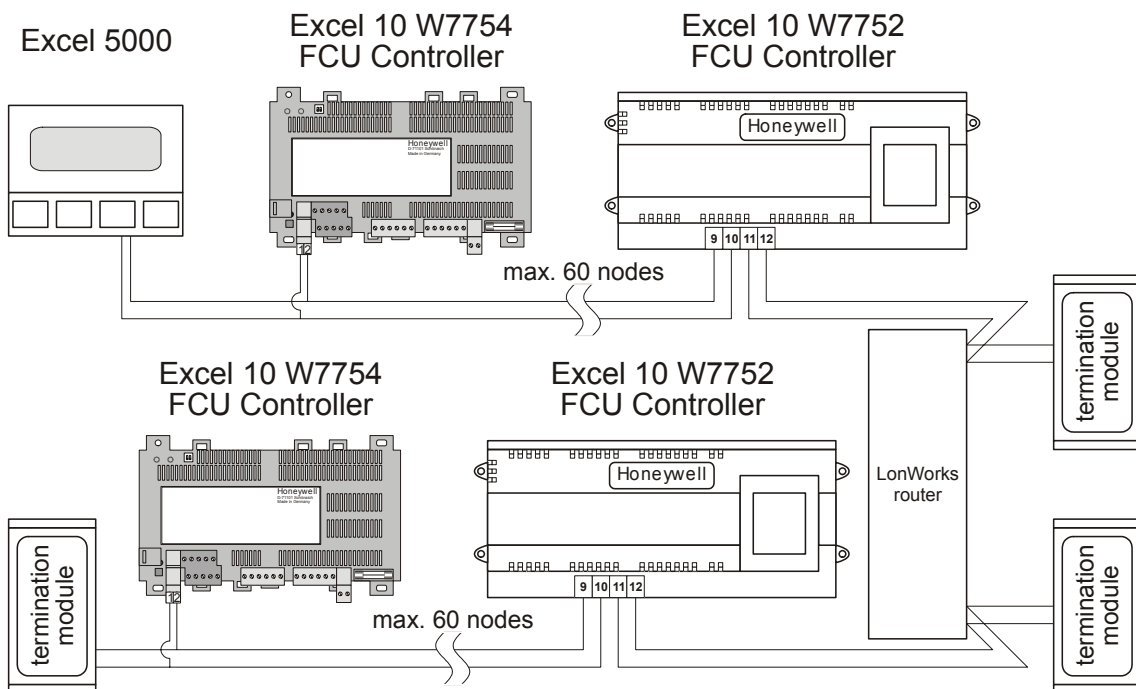

Fig. 14. LONWORKS wiring layout for two daisy-chain network segments

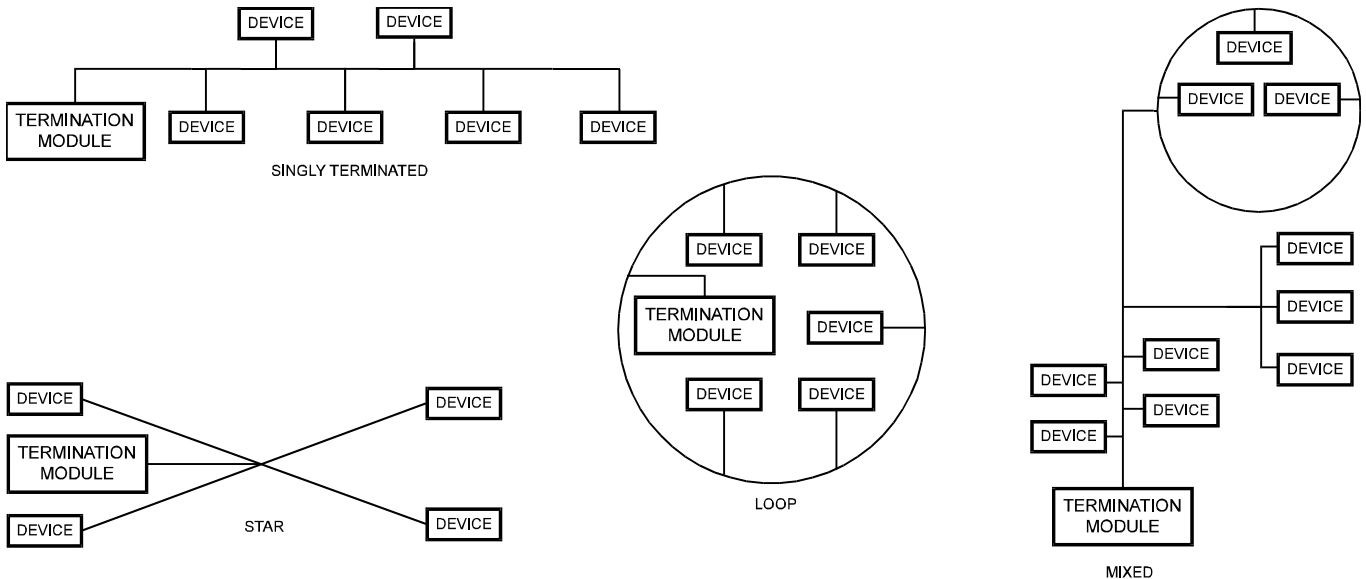

Fig. 15. Free topology LonWorks layout examples

NOTE: See section "LONWORKS Termination" on page 23 for additional details.

IMPORTANT

Notes on Communications Wiring:

- All field wiring must conform to local codes and ordinances.
- Do not use different wire types or gauges on the same LONWORKS segment. The step change in line impedance characteristics would cause unpredictable reflections on the LONWORKS network. When using different types is unavoidable, use a Q7751A Router at the junction.
- Do not use shielded cable for LONWORKS wiring runs. The higher capacitance of the shielded cable will cause degradation of communications throughput. In noisy (high EMI) environments, avoid wire runs parallel to noisy power cables, or lines containing lighting dimmer switches, and keep at least 3 in. (76 mm) of separation between noisy lines and the LONWORKS cable.
- Make sure that neither of the LONWORKS wires is grounded.

Power Wiring

IMPORTANT

Notes on Power Wiring:

- All field wiring must conform to local codes and ordinances.
- See Table 10 for permitted wire sizes.
- To minimize EMI noise, do not run Triac and/or relay output wires in the same conduit as the input wires or the LONWORKS communications loop.
- To comply with CE requirements, in the case of devices having a voltage range of 50 to 1000 Vac or 75 and 1500 Vdc which are not provided with a supply cord and a plug or with other means for disconnection from the supply having a contact separation of at least 3 mm in all poles, the means for disconnection must be incorporated in the fixed wiring.

Step 4. Prepare Wiring Diagrams

General Considerations

The purpose of this step is to assist the application engineer in developing job drawings to meet job specifications.

NOTE: For field wiring, when two or more wires are to be attached to the same connector block terminal, be sure to twist them together. Deviation from this rule can result in improper electrical contact.

Table 10 lists wiring types, sizes, and length restrictions for Excel 10 FCU Controller products.

Table 10. Field wiring reference table (US part numbers shown)

wire function	recommended min. wire size AWG (mm ²)	construction	specification or requirement	vendor wire type	max. length ft (m)
LONWORKS (plenum)	14 to 20 AWG (2.0 to 0.5 mm ²)	twisted pair solid conductor, non-shielded.	Level IV 140°F (60°C) rating	Honeywell (US) AK3791 (one twisted pair) AK3792 (two twisted pairs) (Europe: Belden 9H2201504)	See Step 2
LONWORKS (non-plenum)*	14 to 20 AWG (2.0 to 0.5 mm ²)	twisted pair solid conductor, non-shielded.	Level IV 140°F (60°C) rating	Honeywell (US) AK3781 (one twisted pair) AK3782 (two twisted pairs) (Europe: Belden 9D220150)	See Step 2
input wiring, sensors, contacts	14 to 20 AWG (2.0 to 0.5 mm ²)	multi-conductor (usually five-wire cable bundle); for runs >100 ft (30 m), twisted pair or shielded cable is recommended.	140°F (60°C) rating	Standard thermostat wire	82.5 ft (25 m)
output wiring, actuators, relays	14 to 20 AWG (2.0 to 0.5 mm ²) 20 AWG (0.5 mm ²) acceptable for short runs	any pair non-shielded (use heavier wire for longer runs).	NEC Class 2 140°F (60°C) rating	Honeywell (US) AK3702 (18 AWG) AK3712 (16 AWG) AK3754 (14 AWG) or equivalent	200 ft (60 m)
power wiring	14 to 20 AWG (2.0 to 0.5 mm ²)	any pair non-shielded (use heavier wire for longer runs).	NEC Class 2 140°F (60°C) rating	Honeywell (US) AK3754 (14 AWG) (twisted pair) AK3909 (14 AWG) single conductor or equivalent	Limited by line loss effects on power consumption. (See Line Loss subsection.)

NOTE: PVC wire must not be used where prohibited by local fire regulations.

Terminal Block Assignment and Wiring Example for the W7752 Controller

Table 11 illustrates terminal block assignments and wiring for an example Excel 10 W7752 FCU Controller installation. Table 12 lists wiring information for all possible actuator types.

Table 11. W7752 Controller: Overview of terminals and functions (by model)

terminal #	function	model				
		D	E	F	G	J
1	GND serving terminals 2 and 3	✓	✓	✓	✓	✓
2	a digital input, configurable (using the LNS plug-in) to read input e.g. from a window contact, an occupancy sensor, etc.	✓	✓	✓	✓	✓
3	a digital output, permanently configured to write output switching the wall module's LED ON/OFF	✓	✓	✓	✓	✓
4	an analog input, permanently configured to read input from a wall module's temperature setpoint adjustment knob	✓	✓	✓	✓	✓
5	an analog input, permanently configured to read input on whether the wall module's 3-speed fan control knob has been set to AUTO, OFF, LOW, MEDIUM, or HIGH and whether the wall module's "occupancy override" button has been pressed	✓	✓	✓	✓	✓
6	an analog input, permanently configured to read input from a room temperature sensor	✓	✓	✓	✓	✓
7	GND serving terminals 4, 5, and 6	✓	✓	✓	✓	✓
8	not used	--	--	--	--	--
9+10	receiving/sending data on the LONWORKS network	✓	✓	✓	✓	✓
11+12	sending/receiving data on the LONWORKS network	✓	✓	✓	✓	✓
13	a common terminal for terminals 14 and 15	✓	✓	✓	✓	✓
14	a triac output, permanently configured to write output to OUT1, opening it	✓	✓	✓	✓	✓
15	a triac output, permanently configured to write output to OUT1, closing it	✓	✓	✓	✓	✓
16	a common terminal for terminals 17 and 18	✓	✓	✓	✓	✓
17	a triac output, permanently configured to write output to OUT2, opening it	✓	✓	✓	✓	✓
18	a triac output, permanently configured to write output to OUT2, closing it	✓	✓	✓	✓	✓
19	a common terminal for terminals 20, 21, and 22	✓	✓	✓	✓	✓
20 ⁽¹⁾	relay 1, permanently configured to write output to a three-speed fan, setting it to LOW	✓	✓	✓	✓	✓
21 ⁽¹⁾	relay 2, permanently configured to write output to a three-speed fan, setting it to MEDIUM	✓	✓	✓	✓	✓
22 ⁽¹⁾	relay 3, permanently configured to write output to a three-speed fan, setting it to HIGH	✓	✓	✓	✓	✓
23	the "L" terminal of the power supply (230 Vac, 115 Vac, or 100 Vac, respectively)	230	230	115	115	100
24	the "N" terminal of the power supply (230 Vac, 115 Vac, or 100 Vac, respectively)	230	230	115	115	100
25+26	relay 4, permanently configured to write output to a hardwired electrical reheat coil, switching it ON/OFF	✓	--	✓	--	--

⁽¹⁾ If all three relays (terminals 20, 21, and 22) are switched OFF, the three-speed fan will likewise be switched OFF.

Using Honeywell's LNS plug-in, you can configure the controller's triac outputs and relay outputs for a variety of different functions. E.g. the triac outputs can be configured for connection to either a floating drive or to a thermal actuator. Once the outputs have been configured, the corresponding devices can be directly connected to them.

Table 12. Output assignments of Excel 10 W7752 FCU Controller for various actuator types

output type	out 1 terminal			out 2 terminal		
	13	14	15	16	17	18
floating	24 Vac	open	close	24 Vac	open	close
1-stage	24 Vac	ON/OFF	—	24 Vac	ON/OFF	—
2-stage	24 Vac	stage 1	stage 2	24 Vac	stage 1	stage 2
3-stage	24 Vac	stage 1	stage 2	24 Vac	stage 1	stage 2
		stage 3			stage 3	
PWM	24 Vac	PWM	—	24 Vac	PWM	—
thermal	24 Vac	ON/OFF	—	24 Vac	ON/OFF	—

Terminal Block Assignment and Wiring Example for the W7754 Controller

Table 13 lists the terminals and their functions of the Excel 10 W7754 FCU Controller. Table 14 lists wiring information for all possible actuator types.

Table 13. W7754 Controller: Overview of terminals and functions (by model)

terminal #	function	model				
		K	L	M	N	P
1+2	receiving/sending data on the LONWORKS network; removable plug	✓	✓	✓	✓	✓
3	a digital input, configurable (using the LNS plug-in) to read input e.g. from a window contact, an occupancy sensor, etc.	✓	✓	✓	✓	✓
4	an analog input, permanently configured to read input from a wall module's temperature setpoint adjustment knob	✓	✓	✓	✓	✓
5	an analog input, permanently configured to read input from a room temperature sensor	✓	✓	✓	✓	✓
6	GND serving terminals 4, 5, 9, 10, and 11	✓	✓	✓	✓	✓
7	not used	--	--	--	--	--
8	GND serving terminal 3	✓	✓	✓	✓	✓
9	a digital output, permanently configured to write output switching the wall module's LED ON/OFF	✓	✓	✓	✓	✓
10	an analog input, permanently configured to read input on whether the wall module's 3-speed fan control knob has been set to AUTO, OFF, LOW, MEDIUM, or HIGH and whether the wall module's "occupancy override" button has been pressed	✓	✓	✓	✓	✓
11 ⁽¹⁾	a digital input, permanently configured to read input on whether a window contact is "open" or "closed"	✓	✓	✓	✓	✓
12	not used	--	--	--	--	--
13+14	relay 4, permanently configured to write output to a hardwired electrical reheat coil, switching it ON/OFF	--	--	--	--	✓
15	a common terminal for terminals 16, 17, and 18	✓	✓	✓	✓	✓
16 ⁽²⁾	relay 3, permanently configured to write output to a three-speed fan, setting it to HIGH	✓	✓	✓	✓	✓
17 ⁽²⁾	relay 2, permanently configured to write output to a three-speed fan, setting it to MEDIUM	✓	✓	✓	✓	✓
18 ⁽²⁾	relay 1, permanently configured to write output to a three-speed fan, setting it to LOW	✓	✓	✓	✓	✓
19	a triac output, permanently configured to write output to OUT1, closing it	--	--	--	--	✓
20	a triac output, permanently configured to write output to OUT1, opening it	--	✓	--	✓	✓
21	a triac output, permanently configured to write output to OUT2, closing it	--	--	--	--	✓
22	a triac output, permanently configured to write output to OUT2, opening it	✓	✓	--	✓	✓
23	a common terminal for terminals 19 and 20	✓	✓	--	✓	✓
24	a common terminal for terminals 21 and 22	✓	✓	--	✓	✓
25	"N" terminal of power supply (24 Vac or 230 Vac, respectively); removable plug	230	24	230	230	230
26	"L" terminal of power supply (24 Vac or 230 Vac, respectively); removable plug	230	24	230	230	230

⁽¹⁾ This digital input can be enabled / disabled using the right DIP switch located on the top of the controller.

⁽²⁾ If all three relays (terminals 16, 17, and 18) are switched OFF, the three-speed fan will likewise be switched OFF.

Additionally, the W7754K1001 features an extra socket (located to the left of the terminal blocks) containing a digital output suitable for attachment to a solid-state relay employed for low-voltage PWM control in high-current electrical reheat applications.

Using Honeywell's LNS plug-in, you can configure the controller's triac outputs and relay outputs for a variety of different functions. E.g. the triac outputs can be configured for connection to either a floating drive or to a thermal actuator. Once the outputs have been configured, the corresponding devices can be directly connected to them.

Table 14. Output assignments of Excel 10 W7754 FCU Controller for various actuator types

output type	stage	OUT1		OUT2	
		19	20	21	22
floating	--	close	open	close	open
1-stage	0	--	OFF	--	OFF
	1	--	ON	--	ON
2-stage	0	OFF	OFF	OFF	OFF
	1	OFF	ON	OFF	ON
	2	ON	OFF	ON	OFF
3-stage	0	OFF	OFF	OFF	OFF
	1	OFF	ON	OFF	ON
	2	ON	OFF	ON	OFF
	3	ON	ON	ON	ON
PWM	--	--	PWM	--	PWM
thermal	--	--	ON/OFF	--	ON/OFF

LONWORKS Termination

One or two LONWORKS terminations are required, depending on the given LonWorks bus layout.

Double termination is required only when the network is a daisy-chain configuration and the total wire length is greater than 1640 ft (500 m). The max. lengths described in Step 2 must be adhered to for either a daisy chain or free topology LONWORKS layout. See Fig. 17 for connection details for a doubly terminated bus. See Fig. 18 for connection details for a singly terminated bus.

Two different LONWORKS termination modules are available:

- LONWORKS termination module, order no.: **209541B**
- LONWORKS connection / termination module (mountable on DIN rails and in fuse boxes), order no.: **XAL-Term**

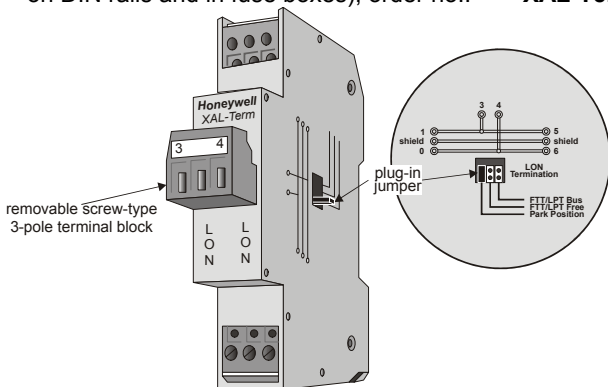

Fig. 16. LONWORKS connection and termination module

NOTE: The Q7750A Zone Manager has an internal termination circuit, although jumpers are required at the terminal block to connect it. See form number 95-7509 for details.

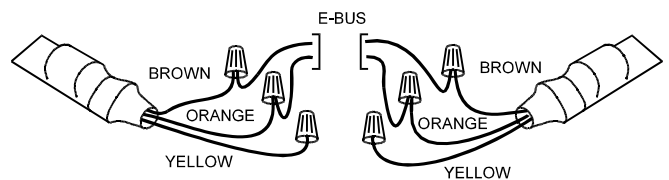

Fig. 17. Termination Module connections for a doubly-terminated FTT network

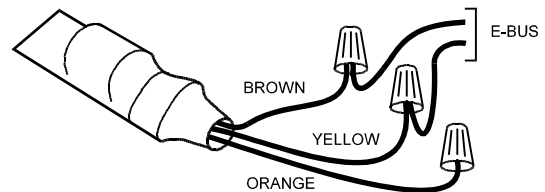

Fig. 18. Termination Module connections for a singly-terminated FTT network

Step 5. Order Equipment

After compiling a bill of materials through completion of the previous application steps, refer to Table 15 for ordering information. Contact Honeywell for information about controllers and Excel 10 wall modules with no logo.

Table 15. Excel 10 FCU Controller ordering information

Part Number	Product Description	Comments
Excel 10 FCU Controllers		
W7752D2007	230 Vac, FTT LONWORKS version w/ relay for electrical reheat applications	
W7752E2004	230 Vac, FTT LONWORKS version w/o relay for electrical reheat applications	
W7752F2002	115 Vac, FTT LONWORKS version version w/ relay for electrical reheat applications	
W7752G2000	115 Vac, FTT LONWORKS version w/o relay for electrical reheat applications	
W7752J2003	100 Vac, FTT LONWORKS version w/o relay for electrical reheat applications	
W7754K1001	230 Vac, FTT LONWORKS version w/o relay for electrical reheat applications; digital output for low-voltage PWM control of solid-state relay for high-current electric reheat applications; one triac	
W7754L1009	24 Vac, FTT LONWORKS version w/o relay for electrical reheat applications; two triacs	
W7754M1007	230 Vac, FTT LONWORKS version w/o relay for electrical reheat applications	
W7754N1004	230 Vac, FTT LONWORKS version w/o relay for electrical reheat applications; two triacs	
W7754P1000	230 Vac, FTT LONWORKS version w/ relay for electrical reheat applications; four triacs	
Excel 10 Wall Modules		
T7460, T7560		See Excel 10 wall module literature for details.
Excel 10 Sensors		
C7068A1007 (Europe)	Air Temperature Sensor	Return air
Echelon-Based Components and Parts		
209541B	FTT Termination Module	Two required per LONWORKS segment.
205979A (US only)	SLTA Connector Cable for LONWORKS bus	Serial interface to wall module or controller.
Cabling		
—	Serial Interface Cable, male DB-9 to female DB-9 or female DB-25.	Obtain locally from any computer hardware vendor.
Honeywell (US) AK3791 (one twisted pair) AK3792 (two twisted pairs) Belden (Europe) 9H2201504	LONWORKS (plenum): 14 to 20 AWG (2.0 to 0.5 mm ²) twisted pair solid conductor, non-shielded.	Level IV 140°F (60°C) rating
Honeywell (US) AK3781 (one twisted pair) AK3782 (two twisted pairs) Belden (Europe) 9D220150	LONWORKS (non-plenum): 14 to 20 AWG (2.0 to 0.5 mm ²) twisted pair solid conductor, non-shielded.	Level IV 140°F (60°C) rating
Honeywell (US) AK3725	Inputs: 18 AWG (1.0 mm ²) five wire cable bundle.	Standard thermostat wire
Honeywell (US) AK3752 (typical or equivalent)	Outputs/Power: 14 to 18 AWG (2.0 to 1.0 mm ²).	NEC Class 2 140°F (60°C) rating
Honeywell (US) AK3702 (typical or equivalent)	18 AWG (1.0 mm ²) twisted pair.	Non-plenum
Honeywell (US) AK3712 (typical or equivalent)	16 AWG (1.5 mm ²) twisted pair.	Non-plenum
Honeywell (US) AK3754 (typical or equivalent)	14 AWG (2.0 mm ²) two conductor.	Non-plenum

Step 6. Configure Controllers

General

This section will provide details on the configuration options for Excel 10 FCU Controllers. See Appendix C for reference information.

Using Plug-Ins

The configuration process is primarily performed in a series of screens seen as file tabs under the menu option **Application Selection** and is easily followed using the tables included in this section. There are 9 file tabs:

1. Output
2. Input
3. Equipment Control
4. Fan
5. Switching Levels
6. Zone Options
7. Miscellaneous
8. PID
9. Wiring (information only, no configuring).

The specific parameters to be configured in each of these four categories are tabulated in the following subsections. For a complete list of all Excel 10 FCU Controller NV's, see Appendix C.

Output

The available options for output configurations with the default values shown are listed in Table 16. See section "Configurations" on page 12 for more information about parameters.

Table 16. FCU Controller output configuration options and default configurations

function	configuration options	default configuration W7752		default configuration W7754				
		D,F	E,G,J	K ⁴	L	M	N	P
model		D,F	E,G,J	K ⁴	L	M	N	P
system type	2-pipe (1 valve) 4-pipe (2 valves)	4-pipe	4-pipe	4-pipe		2-pipe	4-pipe	
fan type	no fan 1-speed fan 2-speed fan 3-speed fan	3-speed	3-speed	3-speed				
relay 4 (reheat relay)	reheat network control (free use) not used	reheat	not used	not used				reheat
output 1 (triac 1 and 2) ³ control ¹	not used cooling heating heat/cool changeover	heating	heating	heating				
output 1 (triac 1 and 2) ³ type	floating floating-mid ² 1-stage 2-stage 3-stage PWM thermal	floating	floating	PWM	ther- mal	floating	ther- mal	floating
output 2 (triac 3 and 4) ³ control ¹	not used cooling heating heat/cool changeover	cooling	cooling	cooling				
output 2 (triac 3 and 4) ³ type	floating floating-mid ² 1-stage 2-stage 3-stage PWM thermal	floating	floating	thermal		floating	ther- mal	floating

Notes:

1. The output mode settings apply only to a 4-pipe system. In a 2-pipe system, output 1 will always operate in the changeover mode.
2. The floating-mid option is for changeover applications, only, and uses only one of the two outputs.
3. The operation of the triacs based upon the output type is given in Table 12 on page 21 and in Table 14 on page 23.
4. W7754K1001 is equipped with a low-voltage digital output suitable for connection to a solid-state relay employed for low-voltage PWM control in high-current electric reheat applications; this digital output is activated if output 1 type is set to either "PWM" or "thermal".

Input

The available options for input configurations with the default values shown are listed in Table 17. See sections "Control Provided" and "Configurations" above for more information on parameters.

Table 17. FCU Controller input configuration options

function	configuration options	default
space temperature sensor	no sensor sensor	sensor
bypass button	none - bypass button is disabled. bypass unoccupied - bypass button overrides current mode to occupied for configurable bypass time for button press of 1.1 to 4 seconds (single press with T7560) or permanently overrides to unoccupied for button press of 4.1 to 7 seconds (more than 5 seconds with T7560). bypass - bypass button only overrides current mode to occupied and to cancel the override again.	bypass unoccupied
LED/LCD	LED override - shows override from bypass button or from network. LED occupancy - shows effective occupancy mode. LCD display - only used with T7560 Wall Modules; occupancy mode is represented by different symbols.	LED override
fan speed switch (or respective T7560 setting)	no switch 3-position switch 4-position switch 5-position switch	5-position switch
setpoint knob	no knob relative absolute middle	relative
min. limit setpoint pot	limit for setpoint knob in either degrees F (absolute setpoint, 53.6 to 86 °F) or DDF (relative setpoint, -9 to 9 DDF) (limit for setpoint knob in either degrees C (absolute setpoint, 12 to 30°C) or K (relative setpoint, -5 to 5 K))	-9 DDF (53.6 °F for absolute setpoint) (-5 K (12 °C for absolute setpoint))
max. limit setpoint pot	limit for setpoint knob in either degrees F (absolute setpoint, 53.6 to 86 °F) or DDF (relative setpoint, -9 to 9 DDF) (limit for setpoint knob in either degrees C (absolute setpoint, 12 to 30 °C) or K (relative setpoint, -5 to 5 K))	9 DDF (86 °F for absolute setpoint) (5 K (30 °C for absolute setpoint))
digital input	not used window closed occupied sensor cool changeover window open unoccupied sensor heat changeover movement no movement	not used

Notes:

1. The temperature sensor option **no sensor** requires that either the FCU Controller be configured as a slave unit receiving heating and cooling control levels from the master unit via the network, or that it receive temperature information over the network from another device.
2. The digital input option to be selected is the condition in which the input will be high (switch contact closed).
3. Furthermore, all W7754 controllers are equipped with an additional digital output which is permanently assigned to the function window contact. This digital input is not visible in the configuration with the plug-in. This digital input can be enabled / disabled using the right DIP switch located on the top of the controller

Equipment Control

The available options for equipment control configurations with the default values shown are listed in the following table. See section "Configurations" on page 12 for more information about parameters.

Table 18. FCU Controller equipment control configuration options

function	configuration options	default
output 1 fan interlock	enabled / disabled	disabled
output 2 fan interlock	enabled / disabled	disabled
output 1 valve direction ¹	direct / reverse	direct
output 2 valve direction ¹	direct / reverse	direct
output 1 min. stage OFF time	0 to 600 seconds	90 s
output 2 min. stage OFF time	0 to 600 seconds	90 s
output 1 valve run time/PWM period/min. stage ON time	floating - valve run time (20 to 600 seconds) PWM - cycle time (20 to 600 seconds) 1, 2, and 3-stage – min. ON time (0 to 1200 seconds)	150 s
output 2 valve run time/PWM period/min. stage ON time	floating - valve run time (20 to 600 seconds) PWM - cycle time (20 to 600 seconds) 1, 2, and 3-stage – min. ON time (0 to 1200 seconds)	150 s
reheat switching level	0 to 100%	100%
reheat hysteresis	0 to 100%	5%
PWM zero position ²	0 to 100%	0%
PWM full position ²	0 to 100%	100%

Notes:

1. Valve action settings apply to floating, PWM, or thermal types.
2. Settings apply to both actuators if both are PWM.

Fan

Available options for fan control are listed in the following table. See section "Configurations" on page 12 for more information about parameters.

Table 19. FCU Controller fan configuration options

function	configuration options	default
fan occupancy mode	continuous during occupied mode; automatic, based on control algorithm	automatic
fan min. ON time ¹	0 to 1200 seconds	0
fan min. OFF time ¹	0 to 1200 seconds	0
fan run-up time ¹	(with fan interlock only) 0 to 600 seconds	0
fan overrun time ¹	(with fan interlock only) 0 to 600 seconds	0

Notes:

1. Fan run time options apply to all fan speeds.

Switching Levels

See section "Configurations" on page 12 for more information about parameters.

Table 20. FCU Controller switching levels configuration options

function	configuration options	default
cooling stage 1 switching level	0 to 100%	5%
heating stage 1 switching level	0 to 100%	5%
cooling stage 2 switching level	0 to 100%	50%
heating stage 2 switching level	0 to 100%	50%
cooling stage 3 switching level	0 to 100%	75%
heating stage 3 switching level	0 to 100%	75%
cooling hysteresis	0 to 100%,	10%
heating hysteresis	0 to 100%	10%

Notes:

1. Stage switching levels and hysteresis are used for fan control as well as multi-stage heating/cooling outputs control.

Zone Options

The Zone configuration options are listed in the following table. See section "Configurations" on page 12 for more information about parameters.

Table 21. FCU Controller zone configuration options

function	configuration options	default
cooling occupied setpoint	50 to 95°F (10 to 35°C)	73.4°F (23°C)
heating occupied setpoint	50 to 95°F (10 to 35°C)	69.8°F (21°C)
cooling standby setpoint	50 to 95°F (10 to 35°C)	77°F (25°C)
heating standby setpoint	50 to 95°F (10 to 35°C)	66.2°F (19°C)
cooling unoccupied setpoint	50 to 95°F (10 to 35°C)	82.4°F (28°C)
heating unoccupied setpoint	50 to 95°F (10 to 35°C)	60.8°F (16°C)

Notes:

1. Ensure that unoccupied heating < occupied heating < occupied cooling < unoccupied cooling and standby heating < standby cooling.

Miscellaneous

The options available in the Miscellaneous tab are listed in the following table. See section "Configurations" on page 12 for more information about parameters.

Table 22. FCU Controller miscellaneous configuration options

function	configuration options	default
Bypass time	0 to 1080 minutes	180 minutes
Override priority	last wins - the last command from either the wall module or from the network has priority. network wins - a network command always has priority until canceled.	last wins
Demand limit control bump	0 to 18 DDF (0 to 10 K)	3.6 DDF (2 K)
Cool rec ramp (cooling optimum start gradient)	-36 DDF/hour to 0 (-20 K/hour to 0)	0
Heat rec ramp (heating optimum start gradient)	0 to 36 DDF/hour (0 to 20 K/hour)	0

PID

The options for configuring PID parameters with defaults are shown in the following table. See section "Configurations" on page 12 for more information about parameters.

Table 23. FCU Controller PID configuration options

function	configuration options	default
cooling proportional gain ¹	P control: 2.25 to 180 DDF (1.25 to 100 K) (0 = disable) PI control: 3.6 to 180 DDF (2 to 100 K) (0 = disable)	36 DDF (20 K)
heating proportional gain ¹	P control: 2.25 to 180 DDF (1.25 to 100 K) (0 = disable) PI control: 3.6 to 180 DDF (2 to 100 K) (0 = disable)	36 DDF (20 K)
cooling reset time	10 to 3200 seconds (0 = disable)	250 s
heating reset time	10 to 3200 seconds (0 = disable)	250 s
cooling derivative time	1 to 3200 seconds (0 = disable)	0
heating derivative time	1 to 3200 seconds (0 = disable)	0
cooling boost temperature	0.9 to 18 DDF (0.5 to 10 K) (0 = disable)	1.8 DDF (1 K)
heating boost temperature	0.9 to 18 DDF (0.5 to 10 K) (0 = disable)	1.8 DDF (1 K)

Notes:

1. Prior to version 1.0.3, the minimum proportional gain was 7.2 DDF (4 K) for all control algorithms.

Commissioning

Commissioning is the process of writing the LONWORKS[®] addresses, the binding information and the configuration to the Excel 10 Controller. Any LNS tool can be used to perform these activities, as described in Appendix B.

ID Number

Each Excel 10 FCU Controller is shipped with an internal Identification Number from the factory called the Neuron ID[®]. The ID number can either be manually entered or it can be received from the network. Pressing the bypass push-button on the Excel 10 wall module for an FCU Controller when it is in Service Mode causes it to broadcast a service message containing its Neuron ID number. This ID number is on a removable sticker on the controller housing and can be typed in manually.

Step 7. Troubleshooting

Troubleshooting Excel 10 FCU Controllers and Wall Modules

In addition to the following information, refer to the various Checkout and Test manuals for these products. See Applicable Literature section for form numbers.

Alarms

When an Excel 10 FCU Controller has an alarm condition, it reports it to the central node on the LonWorks network via the variable nvoAlarm. See Table 24. The information contained in nvoAlarm is:

- Subnet Number: The LonWorks subnet that contains the Excel 10 FCU Controller node that has the alarm condition.
- Node Number: The Excel 10 FCU Controller node that has the alarm condition.
- Alarm Type: The specific alarm being issued and return to normal. An Excel 10 FCU Controller can provide the alarm types listed in Table 24.

All current alarms are contained in a variable called nvoAlarmStatus which is composed of three bytes (nvoAlarmStatus.alarm_bit[n] with n = 0 through 2) with a bit corresponding to each of the alarms listed in Table 24. The coding is ordered in that the least significant bit of nvoAlarmStatus.alarm_bit[0] corresponding to alarm type 1, the most significant bit corresponding to alarm type 8, the least significant bit of nvoAlarmStatus.alarm_bit[1] corresponding to alarm type 9, and so on. Even alarms that are suppressed in nvoAlarm (see below) are contained in nvoAlarmStatus.

Also, the Excel 10 FCU Controller variables, nvoAlarmLog.type[n], where n is 0 through 4, that store the last five alarms to occur in the controller, are available. Certain alarm conditions are suppressed conditionally as follows:

If an input network variable with failure detect is bound to the same node as nvoAlarm, then nvoAlarm and nvoAlarmLog do not report the related FCU Controller variable receive failure error and its associated return to normal. Suppression only occurs when the nvoAlarm is bound to only one node using LonWorks subnet/node addressing and only after the input variable has actually received a network variable from the node since the latest application restart (or power-up condition

Table 24. Excel 10 FCU Controller alarms.

Name of alarm or alarm bit	alarm type number	meaning of alarm code or alarm bit
No Alarm/Return to Normal:		
RETURN_TO_NORMAL	128	Return to no error after being in an error condition. This code is added numerically to another alarm code to indicate that the error condition has returned to normal.
ALARM_NOTIFY_DISABLED	255	The alarm reporting has been turned OFF by the nviManualMode =SUPPRESS_ALARMS. No more alarms are reported until nviManualMode turns ON alarm reporting or upon application restart.
ALM_NO_ALARM	0	No errors since last application restart; initial condition
FCU Alarms:		
ALM_NODE_OFF	1	The control algorithm has stopped due to controller disabled, or in test mode, or other conditions
ALM_FROST	2	The space temperature is below the frost alarm limit. The alarm condition remains until the temperature exceeds the alarm limit plus hysteresis.
ALM_INVALID_SETPNT	3	One of the setpoints is not in the valid range
ALM_TEMP_SENSOR_FAIL	4	Temperature sensor failed
ALM_SETPNT_KNOB_FAIL	5	Remote setpoint potentiometer failed
ALM_FAN_SPEED_SW_FAIL	6	Fan speed switch failed
ALM_FAN_FAILURE	7	Fan is commanded to be ON, but the air flow detector input does not detect the fan running.
ALM_COMFAIL_SPACE_TEMP	8	nviSpaceTemp is bound and has failed in receiving an update within its specified FAILURE_DETECT_TIME
ALM_COMFAIL_HVACMODE	9	nviApplicMode is bound and has failed in receiving an update within its specified FAILURE_DETECT_TIME
ALM_COMFAIL_SETPTOFFS	10	nviSetPtOffset is bound and has failed in receiving an update within its specified FAILURE_DETECT_TIME
ALM_COMFAIL_SCHEDOCC	11	nviTodEvent is bound and has failed in receiving an update within its specified FAILURE_DETECT_TIME
ALM_COMFAIL_DLC	12	nviDlcShed is bound and has failed in receiving an update within its specified FAILURE_DETECT_TIME
ALM_COMFAIL_TEMPRESET	13	nviTempReset is bound and has failed in receiving an update within its specified FAILURE_DETECT_TIME
ALM_COMFAIL_ODTEMP	14	nviOdTemp is bound and has failed in receiving an update within its specified FAILURE_DETECT_TIME
ALM_COMFAIL_OCCSENSOR	15	nviSensorOcc is bound and has failed in receiving an update within its specified FAILURE_DETECT_TIME
ALM_COMFAIL_WINDOW	16	nviWindow is bound and has failed in receiving an update within its specified FAILURE_DETECT_TIME
ALM_COMFAIL_MANHEAT	17	nviManHeat is bound and has failed in receiving an update within its specified FAILURE_DETECT_TIME
ALM_COMFAIL_MANCOOL	18	nviManCool is bound and has failed in receiving an update within its specified FAILURE_DETECT_TIME
ALM_HW_SW_MISMATCH	19	The software is not compatible with the hardware configuration specified by the hardware configuration resistor value. Compatibility is checked only once after application restart.

Broadcasting the Service Message

The Service Message allows a device on the LonWorks network to be positively identified. The Service Message contains the controller Neuron ID number and, therefore, can be used to confirm the physical location of a particular Excel 10 FCU Controller in a building.

When an *Assign Neuron ID* command is issued from the LNS tool, the node goes into the SERVICE_MESSAGE mode for one minute. In the SERVICE_MESSAGE mode, pressing the occupancy override button on the remote Excel 10 wall module causes the Service Message to be broadcast on the network. All other functions are normal in the SERVICE_MESSAGE mode. If an FCU Controller does not have a bypass button connected, it can still broadcast the Service Message on the network by temporarily shorting the controller Fan Speed/Bypass input terminal to the AGND terminal on the controller (terminals 5 and 7) with the controller in SERVICE_MESSAGE mode.

Manual Mode

The FCU Controller can be put into a manual mode which allows manual setting of outputs for system checkout. The variable `nviManualMode` must be set to `Mode_Manual` using the LNS tool. Triac outputs can be set to any combination of ON/OFF or can be set to a test position based upon the configured valve runtime/cycle time. The fan relays and reheat relay (W7752D, F and W7754P1000, only) can also be commanded ON/OFF in any combination. The override LED can be commanded ON/OFF in this mode also.

APPENDIX A: USING AN LNS TOOL TO COMMISSION A FAN COIL UNIT

Temperature Sensor Calibration

The temperature sensor in the Excel 10 wall modules can be calibrated to correct for sensor inaccuracies, wire resistance, etc. This allows the Excel 10 FCU Controller to sense the space temperature with a high degree of accuracy.

Procedure

Select the controller being worked on with the LNS tool.

From within the LNS tool, with the desired project loaded and the SLTA (Q7752A) connected to the LonWorks network, perform the following procedure:

1. Select a controller symbol from a network diagram.
2. Click on **Calibrate** from the **Controller** menu. Once the LNS tool logs on to the controller, the **Room Temperature Calibration** dialog box appears.
3. The box displays the **Current Value** of the sensor and the current **Offset**; it also contains a field for entering

the actual **Measured Value**. When a value is typed in and **Calibrate** is clicked, the offset value is automatically calculated, displayed, and written to the Excel 10 FCU Controller.

Calibrated Active Sensor	Calculated Offset	Manually Measured Value
24.09 °C	0.00 K	24.09 °C

Enter Reference Value and press Calibrate.

Calibrate Clear Close Help

Fig. 19. Calibration dialog box

4. Click on **Close** after completing adjustments.

APPENDIX B: CONFIGURING FOR MASTER/SLAVE OPERATION

More than one Excel 10 FCU Controller may be used to control the temperature of a room. In this situation one controller must be identified as the master unit which will perform the temperature control algorithm. The other FCU Controllers in the room are designated as slave units, and their control algorithms are disabled. The slave units receive heating, cooling, and fan output information from the master controller via network variables sent across the LonWorks network. There can be a maximum of one wall module active in the room, and it must be wired directly to the master controller. If a slave controller has a wall module connected to it, the wall module will be ignored.

Configuration of the master controller is the same as for any controller operating alone in a room. Configuration of the slave controllers must follow the rules described in this section. The following sections correspond to the screens in the LNS tool used for configuring Excel 10 FCU Controllers. An additional section discusses binding of network variables to support master/slave configurations.

Output Configuration Options

Slave devices must have their outputs configured identically with the master controller. The same system type and actuator types must be used. Valve run-times, cycle times, and PWM zero and full position configuration options must be the same as well. If the master controller has a reheat output, the slave units must have one; and both must be configured the same. Fan control in the slave units is via network command from the master unit.

IMPORTANT

The fan minimum on-time must be configured to zero in the slave controllers so that the fans in both master and slave units switch ON at the same time.

Input Configuration Options

Slave controllers may have wall modules connected to them, but they must be deactivated while the controllers are operating as slave units. They must be configured for **no temperature sensor** and **no fan speed switch**. The digital input may be used on the slave units for window open/closed or air flow (fan fail) detection and must be configured as such. In the case of window sensing, the window status network variable must be mapped to the master controller as the slave controller does not execute the control algorithm.

Equipment Control Options

Valve action and fan interlock settings must be the same as for the master controller. Output staging hysteresis, minimum stage OFF times, and reheat switching and hysteresis should be the same as in the master controller.

If a fan is used in the slave units, all fan control settings must be the same as in the master controller.

All heating and cooling stage switching levels should be identical to those of the master controller.

Zone Control Options

All zone temperature control options including PID settings and miscellaneous settings are used only by the master controller and are ignored in the slave units.

Network Variable Binding

In a master/slave configuration, the control algorithm is executed in the master controller only. Heating and cooling output as calculated by the control algorithm is then sent via the network to the slave controllers. The master controller output variables nvoHeatOutput and nvoCoolOutput must be bound to the slave input variables nviManHeat and nviManCool respectively.

For a master/slave system using heat/cool changeover, the master controller output variable must be bound to the slave controllers' input NV nviApplicMode unless a changeover contact is connected to the slave devices. The binding of these two NVs is also required in applications where heat/cool energy is not always available.

The T7780 wall module must be connected to the master controller. The master controller output variable nvoFanSpeed must be bound to the slave controllers' input variable nviFanSpeedCmd

IMPORTANT

The OFF position of the fan speed switch on the wall module turns OFF heating and cooling control functions as well as the fan, so the network variable binding described above for fan speed must still be performed as described.

For applications with reheat, the master controller output variable nvoReheat must be bound to the slaves' input variable nviReheatRelay.

APPENDIX C: LON INTERFACE

The tables are divided as follows:

Table C2—Configuration variables

Table C3—Input variables

Table C4—Output variables

Table C5—Unused variables

Table C2. Configuration Variables for Excel 10 FCU Controllers

NV name	field name	engineering units: English (metric) or states plus range	digital state or value	default	comments
nciAppIVer	application_type	UBYTE, 0 to 255		0	This configuration variable specifies the current application number of the Excel 10 application.
nciAppIVer	version_no	UBYTE, 0 to 255		0	This configuration variable specifies the version number of the Excel 10 application.
nciAppIVer	time[0]	UBYTE, 0 to 255		0	The time stamp of the last change to the Excel 10 application configuration. Time meets the ANSI C time stamp requirement specifying the number of seconds elapsed since midnight (0:00:00), January 1, 1970. It is represented in the Intel Format and is four bytes in length.
nciAppIVer	time[1]	UBYTE, 0 to 255		0	See above.
nciAppIVer	time[2]	UBYTE, 0 to 255		0	See above.
nciAppIVer	time[3]	UBYTE, 0 to 255		0	See above.
nciDeviceName	ch[0-17]	UBYTE, 0 to 255		0	This configuration variable specifies the name of each device. This is an ASCII string with a size of 18 characters. A name with all NULLs means that the device has not been configured.
nciLocation		SNVT_str_asc		0x00	This configuration variable is used to provide more descriptive physical location information than can be provided by the Neuron chip's 6 byte location string.
nciMaxSendTime		SNVT_temp_p 0 to 6553 seconds		0 s from factory	This configuration variable specifies the maximum time that expires before the node object automatically transmits nvoStatus. This provides a heartbeat output that can be used by the destination objects to ensure that the node is still healthy. The heartbeat output may be disabled by setting nciMaxSendTime = 0.

Table C2. Configuration Variables for Excel 10 FCU Controllers

NV name	field name	engineering units: English (metric) or states plus range	digital state or value	default	comments
nciRcvHrtBt		SNVT_time_sec 0 to 6553 seconds 0 = Disabled		0 s from factory	<p>This configuration variable specifies the maximum time that elapses after the last update to</p> <ul style="list-style-type: none"> • nviApplicMode • nviDlcShed • nviManCool • nviManHeat • nviSensorOcc • nviSetPtOffset • nviSpaceTemp • nviTodEvent • nviWindow <p>before these NV inputs adopt their default values. Setting nciRcvHrtBt = 0 means, that the assigned NV input does not wait for an periodic update, and that it will never revert to any default when not receiving an update. If nviSpaceTemp and nviApplicMode are not received at regular intervals that are less than the heartbeat time, the controller will assume that there is a communication failure and revert to the "occupied" mode.</p>
nciSndHrtBt		SNVT_time_sec 0 to 6553 seconds 0 = Disabled		0 s from factory	<p>This configuration variable specifies the maximum time that expires before the object automatically transmits the current value of</p> <ul style="list-style-type: none"> • nvoActiveSetPt • nvoAlarm • nvoApplicMode • nvoCoolOutput • nvoFanSpeed • nvoFcuStatus • nvoHeatOutput • nvoReheatt • nvoSensorOcc • nvoSpaceTemp • nvoTerminalLoad • nvoUnitStatus • nvoWindow <p>This provides a heartbeat output that can be used by the destination objects to ensure that the node is still healthy. The heartbeat output may be disabled by setting nciSndHrtBt = 0.</p>
nciCntrlSettings	fan_auto_mode	CONTINUOUS AUTO_MODE	0 1	AUTO_MODE	<p>This configuration variable specifies the fan operation during the "occupied" mode. CONTINUOUS will cause the fan to run even in the zero energy band.</p>

Table C2. Configuration Variables for Excel 10 FCU Controllers

NV name	field name	engineering units: English (metric) or states plus range	digital state or value	default	comments
nciCntrlSettings	fan_run_up_time	SNVT_time_sec 0 to 600 seconds	0	0	This configuration variable specifies the time the fan runs before the outputs are switched ON. It is typically used for electric heat outputs with fan interlock (see nciFcuConfig.fan_interlock_0 and _1). The interlock must be set.
nciCntrlSettings	fan_overrun_time	SNVT_time_sec 0 to 600 seconds	0	0	This configuration variable specifies the time the fan still runs after the control algorithm has turned OFF the cooling/heating outputs. It is typically used for electric heat with fan interlock (see nciFcuConfig.fan_interlock_0 and _1). The interlock must be set. In case of smoke purge the overrun-time will be ignored.
nciCntrlSettings	switch_level_cool[0]	SNVT_lev_percent 0 to 100%, 0 = Disable		5%	This is the switching level to turn ON stage 1 of the cooling equipment (if configured as multistage).
nciCntrlSettings	switch_level_cool[1]	SNVT_lev_percent 0 to 100%, 0 = Disable		50%	This is the switching level to turn ON stage 2 of the cooling equipment (if configured as multistage).
nciCntrlSettings	switch_level_cool[2]	SNVT_lev_percent 0 to 100%, 0 = Disable		75%	This is the switching level to turn ON stage 3 of the cooling equipment (if configured as multistage).
nciCntrlSettings	switch_level_heat[0]	SNVT_lev_percent 0 to 100%, 0 = Disable		5%	This is the switching level to turn ON stage 1 of the heating equipment (if configured as multistage).
nciCntrlSettings	switch_level_heat[1]	SNVT_lev_percent 0 to 100%, 0 = Disable		50%	This is the switching level to turn ON stage 2 of the heating equipment (if configured as multistage).
nciCntrlSettings	switch_level_heat[2]	SNVT_lev_percent 0 to 100%, 0 = Disable		75%	This is the switching level to turn ON stage 3 of the heating equipment (if configured as multistage).
nciCntrlSettings	staging_hysteresis[0]	SNVT_lev_percent 0 to 100%		10%	This configuration variable applies only to cool outputs configured as multistage outputs and specifies the hysteresis between switching the cool stages ON and OFF.
nciCntrlSettings	staging_hysteresis[1]	SNVT_lev_percent 0 to 100%		10%	This configuration variable applies only to heat outputs configured as multistage outputs and specifies the hysteresis between switching the heat stages ON and OFF.
nciCntrlSettings	reheat_switch_level	SNVT_lev_percent 0 to 100%		100%	This configuration variable specifies the switch-over control output level for the reheat output.

Table C2. Configuration Variables for Excel 10 FCU Controllers

NV name	field name	engineering units: English (metric) or states plus range	digital state or value	default	comments
nciCntrlSettings	reheat_hysteresis	SNVT_lev_percent 0 to 100%		5%	This configuration variable specifies the hysteresis between switching the reheat output ON and OFF.
nciCntrlSettings	fan_min_on_time	SNVT_time_sec 0 to 1200 seconds		0	This configuration variable specifies the minimum time the fan has to run when commanded ON by the control algorithm. This time will be ignored in case of smoke purge. The min_on_time starts as soon as the fan is switched on.
nciCntrlSettings	fan_min_off_time	SNVT_time_sec 0 to 1200 seconds		0	This configuration variable specifies the minimum time the fan has to remain OFF when commanded OFF by the control algorithm. This time will be ignored in case of smoke purge. The min_on_time starts as soon as the fan is switched OFF.
nciEnergyManag	si_dlc_setpt_bump	SNVT_temp_p 0 to 18 DDF (0 to 10 K)		3.6 DDF (2 K)	This configuration variable is used to shift the temperature setpoint during demand limit control load shedding. When nviDlcShed is different from zero, the current occupancy setpoint will be decreased by this value for heating and increased for cooling.
nciEnergyManag	si_optstart_grad[0]	SNVT_temp_p -36 to 0 DDF/hr (-20 to 0 K/hr)		0 DDF/hr (0 K/hr)	This configuration variable specifies the cooling gradient used by the optimum start function to calculate the optimum time for starting to decrease the effective setpoint smoothly from the unoccupied or standby cooling setpoint to the occupied cooling setpoint.
nciEnergyManag	si_optstart_grad[1]	SNVT_temp_p 0 to 36 DDF/hr (0 to 20 K/hr)		0 DDF/hr (0 K/hr)	This configuration variable specifies the heating gradient used to determine the optimum time to start increasing the current effective setpoint smoothly to the occupied setpoint at the beginning of scheduled occupancy.
nciFcuConfig	room_temp_sensor	BYTE NO_TEMP_SENSOR NTC_NON_LINEARIZED	0 2	NTC_NON_LINEARIZE D	This configuration variable specifies whether a direct wired room temperature sensor is connected to the node or a room temperature value from the network is used.
nciFcuConfig	fan_speed_switch	BYTE NO_SWITCH THREE_POSITION FOUR_POSITION FIVE_POSITION	0 1 2 3	FIVE_POSITION	This configuration variable specifies the type of fan speed switch on the wall module.

Table C2. Configuration Variables for Excel 10 FCU Controllers

NV name	field name	engineering units: English (metric) or states plus range	digital state or value	default	comments
nciFcuConfig	DI1_config	BYTE DI_WINDOW_CLOSED DI_OCCUPIED_SENSOR DI_AIR_FLOW DI_CHANGEOVER_COOL DI_WINDOW_OPEN DI_UNOCCUPIED_SENS DI_NO_AIR_FLOW DI_CHANGEOVER_HEAT DI_MOVEMENT DI_NO_MOVEMENT DI_NOT_USED	0 1 2 3 4 5 6 7 8 9 255	DI_NOT_USED	This configuration variable specifies the digital input function and type of switch. The option to be selected is the one which is the condition for a closed switch contact (e.g., normally-closed window switch contact = DI_WINDOW_CLOSED, normally-open window switch contact = DI_WINDOW_OPEN). DI_MOVEMENT and DI_NO_MOVEMENT are supported starting with FCU2 version 1.0.3. These configuration settings cause the controller to retain the occupied state for 15 minutes after the last movement is detected.
nciFcuConfig	fan_config	BYTE NO_FAN ONE_SPEED TWO_SPEED THREE_SPEED	0 1 2 3	THREE_SPEED	This configuration variable specifies the type of fan connected to the controller.
nciFcuConfig	output_mode[0]	BYTE OUTP_COOLING OUTP_HEATING OUTP_CHANGEOVER OUTP_NOT_USED	0 1 2 255	OUTP_HEATING	This configuration variable specifies the operating mode of the output 1.
nciFcuConfig	output_mode[1]	BYTE OUTP_COOLING OUTP_HEATING OUTP_CHANGEOVER OUTP_NOT_USED	0 1 2 255	OUTP_COOLING	This configuration variable specifies the operating mode of the output 2. This setting is ignored for nciNumValve = TWO_PIPE.

Table C2. Configuration Variables for Excel 10 FCU Controllers

NV name	field name	engineering units: English (metric) or states plus range	digital state or value	default	comments
nciFcuConfig	output_type[0]	BYTE FLOATING ONE_STAGE TWO_STAGE THREE_STAGE PWM THERMAL FLOATING_MID	0 1 2 3 4 5 6	FLOATING	This configuration variable specifies the output type to drive the connected actuator for the output 1: FLOATING/FLOATING_MID - This setting considers valve_reverse[] and cycle_time[]. Synchronization is performed at every restart and at least once per day. ONE_STAGE - Triac 2 is not used. TWO_STAGE/THREE_STAGE - Triac 1 and 2 used (triac 1 and 2 both ON for stage 3). When configured as multistage, cycle_time and min_stage_off_time are considered. PWM/THERMAL - Triac 2 is not used. Triac 1 operates as a pulse-width modulated output, and the cycle time must be specified in cycle_time[]. For PWM outputs, PwmZeroPosn and PwmFullPosn must also be specified.
nciFcuConfig	output_type[1]	BYTE FLOATING ONE_STAGE TWO_STAGE THREE_STAGE PWM THERMAL FLOATING_MID	0 1 2 3 4 5 6	FLOATING	This configuration variable specifies the output type to drive the connected actuator for the output 2 (see above).
nciFcuConfig	valve_reverse_0	Bit DIRECT REVERSE	0 1	DIRECT	This configuration variable applies to only those outputs that have been configured as FLOATING, PWM, or THERMAL and specifies the direct/reverse operation of output 1.
nciFcuConfig	valve_reverse_1	Bit DIRECT REVERSE	0 1	DIRECT	This configuration variable applies only to those outputs that have been configured as FLOATING, PWM, or THERMAL and specifies the direct/reverse operation of output 2.
nciFcuConfig	fan_interlock_0	Bit NO YES	0 1	NO	This configuration variable configures an interlock between fan and output 1 to provide equipment protection for electric heat or compressor. fan_interlock_0=1 enables interlock, which guarantees output1 to be driven only when the fan is running.
nciFcuConfig	fan_interlock_1	Bit NO YES	0 1	NO	This configuration variable configures an interlock between fan and output 2 to provide equipment protection for electric heat or compressor. fan_interlock_1=1 enables interlock, which guarantees output2 to be driven only when the fan is running.

Table C2. Configuration Variables for Excel 10 FCU Controllers

NV name	field name	engineering units: English (metric) or states plus range	digital state or value	default	comments
nciFcuConfig	cycle_time[0]	SNVT_time_sec 0 to 1200s for stage output 0 to 600s for floating output 20 to 600s for PWM output		150 s for floating	This configuration variable specifies for the output 1 configured as <ul style="list-style-type: none"> • FLOATING: the runtime of the valve (time to run from fully closed to fully open) • PWM: the cycle time • ONE_STAGE, TWO_STAGE, and THREE_STAGE: minimum ON time before switching to the next stage.
nciFcuConfig	cycle_time[1]	SNVT_time_sec 0 to 1200s for stage output 0 to 600s for floating output 20 to 600s for PWM output		150 s for floating	This configuration variable specifies for the output 2 configured as <ul style="list-style-type: none"> • FLOATING: the runtime of the valve (time to run from fully closed to fully open) • PWM: the cycle time • ONE_STAGE, TWO_STAGE, and THREE_STAGE: minimum ON time before switching to the next stage.
nciFcuConfig	min_stage_off_time[0]	SNVT_time_sec 0 to 600 seconds		90 s	This configuration variable is used only for ONE_STAGE, TWO_STAGE, and THREE_STAGE output 1 and specifies the minimum OFF time before switching to the next stage.
nciFcuConfig	min_stage_off_time[1]	SNVT_time_sec 0 to 600 seconds		90 s	This configuration variable is used only for ONE_STAGE, TWO_STAGE, and THREE_STAGE output 2 and specifies the minimum OFF time before switching to the next stage
nciFcuConfig	reheat_config	BYTE REHEAT FREE_USE REL_NOT_USED	0 1 255	REHEAT	This configuration variable specifies the usage of the reheat relay. FREE_USE specifies that the relay is controlled via the network using the nviReheatRelay .
nciFcuConfig	PwmZeroPosn	SNVT_lev_percent 0 to 100%		0%	This configuration variable specifies the zero position for PWM actuators. This setting applies to PWM actuators only and is used for both actuators if both are configured as PWM actuators.
nciFcuConfig	PwmFullPosn	SNVT_lev_percent 0 to 100%		100%	This configuration variable specifies the fully open position for PWM actuators. This setting applies to PWM actuators only and is used for both actuators if both are configured as PWM actuators.
nciFcuGains	si_pid_Xp[0]	SNVT_temp_p 2.25 to 180 DDF (1.25 to 100 K), 0 = Disable		36 DDF (20 K)	This configuration variable specifies the throttling range for use in the proportional portion of the PID loop gain for the cooling mode. The minimum configurable value (not including 0 for disabling) is 3.6 DDF (2 K) for PI or 2.25 DDF (1.25 K) for P control. For versions prior to 1.0.3, the minimum value is 7.2 DDF (4 K).

Table C2. Configuration Variables for Excel 10 FCU Controllers

NV name	field name	engineering units: English (metric) or states plus range	digital state or value	default	comments
nciFcuGains	si_pid_Xp[1]	SNVT_temp_p 2.25 to 180 DDF (1.25 to 100 K), 0 = Disable		36 DDF (20 K)	This configuration variable specifies the throttling range for use in the proportional portion of the PID loop gain for the heating mode. The minimum configurable value (not including 0 for disabling) is 3.6 DDF (2 K) for PI or 2.25 DDF (1.25 K) for P control. For versions prior to 1.0.3, the minimum value is 7.2 DDF (4 K).
nciFcuGains	si_pid_Tn[0]	SNVT_time_sec 10 to 3200 seconds 0 = Disable		250 s	This configuration variable specifies the integral time for use in the integral portion of the PID loop gain for the cooling mode.
nciFcuGains	si_pid_Tn[1]	SNVT_time_sec 10 to 3200 seconds 0 = Disable		250 s	This configuration variable specifies the integral time for use in the integral portion of the PID loop gain for the heating mode.
nciFcuGains	si_pid_Tv[0]	SNVT_time_sec 10 to 3200 seconds 0 = Disable		0 s	This configuration variable specifies the derivative time for use in the derivative portion of the PID loop gain for the cooling mode.
nciFcuGains	si_pid_Tv[1]	SNVT_time_sec 10 to 3200 seconds 0 = Disable		0 s	This configuration variable specifies the derivative time for use in the derivative portion of the PID loop gain for the heating mode.
nciFcuGains	si_boost[0]	SNVT_temp_p 0.9 to 18 DDF (0.5 to 10 K) 0 = Disable		1.8 DDF (1 K)	This configuration variable specifies the temperature range to be added to the cooling setpoint, above which the cooling output is fully open to allow a faster response. For thermal actuators it is the hysteresis for thermal control algorithm.
nciFcuGains	si_boost[1]	SNVT_temp_p 0.9 to 18 DDF (0.5 to 10 K) 0 = Disable		1.8 DDF (1 K)	This configuration variable specifies the temperature range to be subtracted from the heating setpoint, below which the heating output is fully open to allow a faster response. For thermal actuators it is the hysteresis for thermal control algorithm.
nciNumValve		SNVT_count TWO_PIPE FOUR_PIPE	1 2	FOUR_PIPE	This configuration variable specifies a two-pipe system (one valve) or a four-pipe system (two valves). If set to TWO_PIPE, only the output terminals for output1 are used. If set to FOUR_PIPE, output1 and output2 are defined by nciFcuConfig.output_mode[].
nciSetPnts	occupied_cool	SNVT_temp_p 50 to 95°F (10 to 35°C)		73.4°F (23°C)	This is the default setpoint for the occupied cooling setpoint which is used in case there is no locally wired setpoint knob or nviSetpoint has not been bound. Where the ZEB for occupied is used, it is derived from the difference between occupied_cool and occupied_heat.

Table C2. Configuration Variables for Excel 10 FCU Controllers

NV name	field name	engineering units: English (metric) or states plus range	digital state or value	default	comments
nciSetPnts	standby_cool	SNVT_temp_p 50 to 95°F (10 to 35°C)		77°F (25°C)	This is the configured setpoint which applies to the standby cooling mode. Where the ZEB for standby is used, it is derived from the difference between standby_cool and standby_heat.
nciSetPnts	unoccupied_cool	SNVT_temp_p 50 to 95°F (10 to 35°C)		82.4°F (28°C)	This is the configured setpoint which applies to the unoccupied cooling mode.
nciSetPnts	occupied_heat	SNVT_temp_p 50 to 95°F (10 to 35°C)		69.8°F (21°C)	This is the default setpoint for the occupied heating setpoint which is used in case there is no locally wired setpoint knob or nviSetpoint has not been bound. Where the ZEB for occupied is used, it is derived from the difference between occupied_cool and occupied_heat.
nciSetPnts	standby_heat	SNVT_temp_p 50 to 95°F (10 to 35°C)		66.2°F (19°C)	This is the configured setpoint which applies to the standby heating mode. Where the ZEB for standby is used, it is derived from the difference between standby_cool and standby_heat.
nciSetPnts	unoccupied_heat	SNVT_temp_p 50 to 95°F (10 to 35°C)		60.8°F (16°C)	This is the configured setpoint which applies to the unoccupied heating mode.
nciWallMod	ui_bypass_time	UWORD 0 to 1080 minutes		180 min	This configuration variable specifies the time the controller remains in OCCUPIED mode before reverting to the original occupancy mode after pressing the override button at the wall module or initiating BYPASS via the network. When the bypass mode has been activated, the bypass timer is set to ui_bypass_time. When the timer expires, nvoFcuStatus.occ_status.hw_override reverts from OC_BYPASS to OC_NUL to quit the bypass override function.
nciWallMod	si_low_setpt	SNVT_temp_p -9 to 9 DDF (-5 to 5 K) for relative 53.6 to 86°F (12 to 30°C) for absolute		-9 DDF (-5 K) (53.6°F (12°C) for absolute setpoint)	This configuration variable specifies the low limit for the setpoint knob. It can be relative or absolute depending upon the configuration in nciWallMod.set_pnt_knob.
nciWallMod	si_high_setpt	SNVT_temp_p -9 to 9 DDF (-5 to 5 K) for relative 53.6 to 86°F (12 to 30°C) for absolute		9 DDF (5 K) (86°F (30°C) for absolute setpoint)	This configuration variable specifies the high limit for the setpoint knob. It can be relative or absolute depending upon the configuration in nciWallMod.set_pnt_knob.
nciWallMod	si_space_temp_zero_cal	SNVT_temp_p -9 to 9 DDF (-5 to 5 K)		0 DDF (0 K)	The space temperature sensor is corrected by adding this calibration setting (an offset value) to the sensed value.

Table C2. Configuration Variables for Excel 10 FCU Controllers

NV name	field name	engineering units: English (metric) or states plus range	digital state or value	default	comments
nciWallMod	use_wall_mod_st_pt	Bit NO YES	0 1	YES	This configuration variable specifies whether the setpoint used is from the knob on the wall module connected to the controller or from the network via nciTempSetPts. If set to NO, all setpoints to be used come from the network via nciTempSetPts. If set to YES, an additional option set_pnt_knob must be set to specify type of setpoint adjustment (see below).
nciWallMod	set_pnt_knob	2 Bits OFFSET ABSOLUTE_MIDDLE	0 2	OFFSET	This configuration variable specifies specifies the usage of the setpoint knob on the wall module for the occupied setpoint. OFFSET specifies a relative scale on the wall module where the setpoint is calculated by adding the setpoint potentiometer value (± 5 K) to the appropriate value of nciTempSetPts. ABSOLUTE_MIDDLE specifies an absolute scale on the wall module. The setpoint knob directly determines the center point of occupied cooling and heating setpoints. The respective cooling and heating setpoint is determined by the setpoint knob position adding or subtracting half of the user selectable ZEB defined in nciSetPnts.<occ_mode>_cool or nciSetPnts.<occ_mode>_heat . This applies to <occ_mode> OCCUPIED and STANDBY.
nciWallMod	override_type	2 Bits NO_BUTTON BYPASS_UNOCCUPIED BYPASS	0 1 2	BYPASS_UNOCCUPIED	This configuration variable specifies the behavior of the override button. BYPASS_UNOCCUPIED allows overriding the current occupancy mode to OCCUPIED for a configurable bypass time, or causing a permanent override to UNOCCUPIED. BYPASS allows only the temporary override to OCCUPIED and canceling it.
nciWallMod	override_priority	Bit LAST_WINS NETWORK_WINS	0 1	LAST_WINS	This configuration variable specifies the priority of the local (wall module push-button) or central (network interface) override. If NETWORK_WINS is set and the network sends value NUL, then the override button is active.
nciWallMod	display_type	Bit LED_OVERRIDE LED_OCCUPANCY LCD_DISPLAY	0 1 2	LED_OVERRIDE	This configuration variable specifies the display of occupancy and/or override. LED_OVERRIDE shows the override from the bypass button or from the network. LED_OCCUPANCY shows the effective occupancy mode. LCD_DISPLAY is only used for T7560 Wall Modules. The display shows the occupancy mode with different symbols, and the override mode with flashing symbols.

Table C3. Input Variables for Excel 10 FCU Controllers

NV name	field name	engineering units: English (metric) or states plus range	digital state or value	default	comments
nviApplicMode		SNVT_hvac_mode HVAC_AUTO HVAC_HEAT HVAC_COOL HVAC_OFF HVAC_NUL	0 1 3 6 255	HVAC_AUTO (if bound but fails to be received or at application restart)	This input variable coordinates the controller operation with the main equipment controller. Depending upon the available supply energy, the main equipment controller commands the Fan Coil Unit controller to operate in heat mode only, cool mode only or heat and cool mode if appropriate to the configuration. HVAC_AUTO means that both heating and cooling equipment are available, and the current mode is determined by the control algorithm depending upon the room temperature and effective setpoint. HVAC_AUTO is invalid for changeover applications. When the Digital input is configured for Heat/Cool changeover input, this input will always have priority over the network nviApplicMode's HVAC_HEAT or HVAC_COOL.
nviDlcShed		BYTE NORMAL SETPOINT_SHIFT	0 1	0 (if bound but fails to be received or at application restart)	This input variable is from an energy management system. When it is 0, the temperature control algorithm operates in a normal mode. When it is 1, the effective setpoint will be shifted by the amount defined in nciEnergyManag.si_dlc_setpt_bump. For cooling the effective setpoint will be increased, for heating the effective setpoint will be decreased always with regard to the frost protection limit.
nviEmerg		SNVT_hvac_emerg EMERG_NORMAL EMERG_PRESSURIZE EMERG_DEPRESSURIZE EMERG_PURGE EMERG_SHUTDOWN EMERG_NUL	0 1 2 3 4 255	EMERG_NORMAL (at application restart)	This input variable is an emergency input from a device that determines the correct action during a given emergency (such as a fire). <ul style="list-style-type: none"> EMERG_NORMAL, EMERG_NUL: terminate EMERG_ commands and restores the control algorithm. EMERG_PRESSURIZE, EMERG_PURGE, EMERG_SHUTDOWN: heat/cool outputs OFF, fan ON at highest speed. EMERG_DEPRESSURIZE: heat/cool outputs OFF, fan OFF.
nviFanSpeedCmd	value	SNVT_switch 0 to 100%		100% (at application restart)	This input variable allows control of the fan speed by another node, such as another Fan Coil Unit Controller acting as a master in a master/slave relationship.
nviFanSpeedCmd	state	SNVT_switch OFF ON NUL	0 1 255	NUL (at application restart)	See above.
nviInUse		UWORD 0 to 65535		0 (if bound but fails to be received), 65535 (for 60s at application restart)	This input variable is used by the engineering tool or other supervisory node that it is "logged on" to the controller node. It should be set every minute, or the controller will reset it after 60s to automatically log off the supervisory node.

Table C3. Input Variables for Excel 10 FCU Controllers

NV name	field name	engineering units: English (metric) or states plus range	digital state or value	default	comments
nviManCool		SNVT_lev_percent 0 to 100% 163.835% = INVALID			This input variable can be used for master/slave installations where the cool output is controlled by an external controller node. In this case, the output signal of the cooling control algorithm (0-100%) of the master has to be bound to nviManCool and then takes over the task of the local (slave) control algorithm while the switch levels operate as locally configured. The heating output will be closed.
nviManHeat		SNVT_lev_percent 0 to 100% 163.835% = INVALID			This input variable can be used for master/slave installations where the heat output is controlled by an external controller node. In this case, the output signal of the heating control algorithm (0-100%) of the master has to be bound to nviManHeat and then takes over the task of the local (slave) control algorithm while the switch levels operate as locally configured. The cooling output will be closed.
nviManOccCmd		SNVT_occupancy OC_OCCUPIED OC_UNOCCUPIED OC_BYPASS OC_STANDBY OC_NUL	0 1 2 3 255	OC_NUL (at application restart)	This input variable is from an network connected operator interface or other node that indicates the state of manual occupancy control (schedule override). It has priority over the time program (nviTodEvent). When the BYPASS mode is set, the bypass time is active. When the bypass time has elapsed, the master controller automatically sets nviManOccCmd to OC_NUL. nviManOccCmd does not provide a failure detect mechanism in case no periodic update is received.
nviManualMode		BYTE MODE_ENABLE MODE_DISABLE MODE_MANUAL SUPPRESS_ALARMS UNSUPPRESS_ALARMS	0 1 2 3 4	MODE_ENABLE and UNSUPPRESS_ALARMS (at application restart)	This input variable is used to disable the controller's control algorithms in order to manually set its physical outputs. The controller still responds to smoke purge even when disabled or set to manual or factory test mode. It remains unchanged until another mode has been commanded or an application restart has been performed. <ul style="list-style-type: none"> • MODE_ENABLE: starts the control algorithm at an initial state after MODE_DISABLE or MODE_MANUAL. • MODE_DISABLE: all outputs switched OFF, the alarm ALARM_NODE_OFF is issued. • MODE_MANUAL: all control loops are disabled and the alarm ALARM_NODE_OFF is issued. The outputs can be controlled manually via the nviTest command • SUPPRESS_ALARMS: nvoAlarm is not sent and nvoAlarmStatus and nvoAlarmLog are not updated until UNSUPPRESS_ALARMS is set or an application restart. • UNSUPPRESS_ALARMS: releases alarm suppression after SUPPRESS_ALARMS.

Table C3. Input Variables for Excel 10 FCU Controllers

NV name	field name	engineering units: English (metric) or states plus range	digital state or value	default	comments
nviReheatRelay	value	SNVT_switch 0 to 100%		0 (at application restart)	This input variable is used to control the reheat relay via the network. This permits use of the relay as an auxiliary output in applications where reheat is not required as well master/slave applications where the reheat output is controlled by another controller acting as master.
nviReheatRelay	state	SNVT_switch OFF ON NUL	0 1 255	OFF (at application restart)	See above.
nviRequest	object_id	SNVT_obj_request UWORD 0=Node Object 1=Fan Coil Object			This input variable belongs to the Node Object and provides the mechanism to request a particular mode for a particular object within a node.
nviRequest	object_request	object_request_t Enum from Echelon defined RQ_NORMAL RQ_UPDATE_STATUS RQ_UPDATE_ALARM RQ_REPORT_MASK	0 2 4 5		See above. Commanding any modes other the ones listed will result in an "invalid_request" when reading nvoStatus.
nviSensorOcc		SNVT_occupancy OC_OCCUPIED OC_UNOCCUPIED OC_BYPASS OC_NUL	0 1 2 255	OC_NUL (if bound but fails to be received or at application restart)	This input variable allows an occupancy sensor of another Excel 10 controller to be used to indicate the sensed occupancy state of the space. OC_NUL means no input is available because it is not bound, bound but not received periodically, or not configured by nciFcuConfig.DI1_config. More than one occupancy sensor may be bound to nviSensorOcc. If any one sensor detects occupancy, the controller considers the space occupied.
nviSetPoint		SNVT_temp_p 50 to 95°F (10 to 35°C) 327.67°C = INVALID		INVALID (at application restart)	This input variable is used for binding third party nodes to authorize them for setpoint modifications. When this has been bound and a valid update is received, the local configured setpoints will no longer be directly used to determine the current occupancy setpoint. For OCCUPIED and STANDBY modes, this is used with the appropriate ZEB (derived from the configured setpoints), for UNOCCUPIED mode the setpoint does not depend upon this input, but upon nciTempSetPts.unoccupied_cool/_heat only. nviSetpoint is stored in RAM and gets lost after power failure. In this case, the setpoints of nciTempSetPts will be used until a valid nviSetpoint is received.

Table C3. Input Variables for Excel 10 FCU Controllers

NV name	field name	engineering units: English (metric) or states plus range	digital state or value	default	comments
nviSetPtOffset		SNVT_temp_p -18 to 18 DDF (-10 to 10 K) 589.806 DDF (327.67 K) = INVALID		0 (if bound but fails to be received or at application restart)	This input variable is used for binding third party nodes to authorize them for setpoint shifting. nviSetPtOffset is stored in RAM and will be initialized to zero after application restart or power failure. If nviSetPtOffset is bound and fails to be received periodically as configured with nciRcvHrtBt, it will be reset to zero.
nviSpaceTemp		SNVT_temp_p 0 to 104°F (0 to 40°C) 621.806°F (327.67°C) = INVALID		INVALID (if bound but fails to be received or at application restart)	This input variable is the space temperature transmitted from another Excel 10 controller or another node that has a tem- perature sensor wired to it. If bound or has a value other than INVALID, then it is used as the sensed space temperature instead of the wired wall module's temperature. nviSpaceTemp may be set to a value other than INVALID using a LNS tool when nviSpaceTemp is not bound to set the temperature to a fixed value.
nviTest	output1_cmd	BYTE NORMAL_HC_MODE OFF1_OFF2 ON1_OFF2 OFF1_ON2 ON1_ON2 TESTPOSITION	0 1 2 3 4 5	NORMAL_HC_MODE (at application restart)	This input variable is used by factory test, OEM field test, field installation, and field testing to manually command the physical output 1 when the node has been put into manual mode (nviManualMode = MODE_MANUAL). NORMAL_HC_MODE: output 1 remains in its current position OFF1_OFF2, ON1_OFF2, OFF1_ON2, ON1_ON2: set the individual triacs ON or OFF TESTPOSITION: sets output based upon output1_test_pos.
nviTest	output1_test_pos	SNVT_lev_percent 0 to 100%		0 (at application restart)	This input variable is used for the TESTPOSITION of the output1_cmd and is based upon the configured runtime/cycle time.
nviTest	output2_cmd	BYTE NORMAL_HC_MODE OFF1_OFF2 ON1_OFF2 OFF1_ON2 ON1_ON2 TESTPOSITION	0 1 2 3 4 5	NORMAL_HC_MODE (at application restart)	Same as output1_cmd for output 2.
nviTest	output2_test_pos	SNVT_lev_percent 0 to 100%		0 (at application restart)	Same as output1_test_pos for output 2
nviTest	reheat_cmd	BYTE NORMAL_HC_MODE OFF1_OFF2 ON1_ON2	0 1 4	NORMAL_HC_MODE (at application restart)	This input variable is used to test the reheat relay.

Table C3. Input Variables for Excel 10 FCU Controllers

NV name	field name	engineering units: English (metric) or states plus range	digital state or value	default	comments
nviTest	fan_control	BYTE NORMAL_FAN_MODE OFF1_OFF2_OFF3 ON1_OFF2_OFF3 OFF1_ON2_OFF3 ON1_ON2_OFF3 OFF1_OFF2_ON3 ON1_OFF2_ON3 OFF1_ON2_ON3 ON1_ON2_ON3	0 1 2 3 4 5 6 7 8	NORMAL_FAN_MODE (at application restart)	This input variable is used to test the fan speed relays.
nviTest	override_LED	BYTE NORMAL_LED_MODE LED_OFF LED_ON	0 1 2	NORMAL_LED_MODE (at application restart)	This input variable can be used to test the wall module LED when nviManualMode = MODE_MANUAL.
nviTodEvent	current_state	SNVT_tod_event.current_state OC_OCCUPIED OC_UNOCCUPIED OC_STANDBY OC_NUL	0 1 3 255	OC_OCCUPIED (if bound but fails to be received or at application restart)	This input variable indicates to the node whether the space is currently scheduled to be occupied, standby or unoccupied.
nviTodEvent	next_state	SNVT_tod_event.next_state OC_OCCUPIED OC_UNOCCUPIED OC_STANDBY OC_NUL	0 1 3 255	OC_OCCUPIED (if bound but fails to be received or at application restart)	This input variable indicates to the node whether the next scheduled occupancy mode will be occupied, standby or unoccupied. This information is required by the controller to perform the optimum start strategy.
nviTodEvent	time_to_next_state	SNVT_tod_event.time_to_next_s tate UWORD 0 to 2880 minutes		0 (if bound but fails to be received or at application restart)	This input variable specifies the time in minutes until the next change of scheduled occupancy state. This data is also used by the optimum start calculation (see nciEnergyManag).

Table C3. Input Variables for Excel 10 FCU Controllers

NV name	field name	engineering units: English (metric) or states plus range	digital state or value	default	comments
nviWindow	value	SNVT_switch.value 0 to 100%		0 (if bound but fails to be received or at application restart)	This input variable allows a window contact node or another controller to be used as remote window contact. More than one nvoWindow may be bound to one nviWindow, which allows one node to be used to handle several distributed window contacts. In this case the control process assumes an open window if at least one bound window node detects an open window. 'Window Closed' would be assumed if all nvoWindows bound to nviWindow indicate the window being closed for at least the failure detect time (nciSndHrtBt).
nviWindow	state	SNVT_switch.state CLOSED OPEN NO_WINDOW	0 1 255	NO_WINDOW (if bound but fails to be received or at application restart)	See above.

Table C4. Output Variables for Excel 10 FCU Controllers.

NV name	field name	engineering units: English (metric) or states plus range	digital state or value	default	comments
nvoActiveSetPt		SNVT_temp_p 50 to 95°F (10 to 35°C) 621.806°F (327.67°C) = INVALID			This output variable shows the active setpoint of the control algorithm. It is based upon the occupancy setpoints, the offset, and recovery ramping.
nvoAlarm	subnet	UBYTE 0 to 255			This output variable is the LonWorks subnet number (in domain entry 1 of the node's domain table).
nvoAlarm	node	UBYTE 0 to 255			This output variable is the LonWorks node number (in domain entry 1 of the node's domain table).
nvoAlarm <i>(continued)</i>	type	UBYTE ALM_NO_ALARM ALM_NODE_OFF ALM_FROST ALM_INVALID_SETPNT ALM_TEMP_SENSOR_FAIL ALM_SETPNT_KNOB_FAIL ALM_FAN_SPEED_SW_FAIL ALM_FAN_FAILURE ALM_COMFAIL_SPACETEMP ALM_COMFAIL_HVACMODE ALM_COMFAIL_SETPTOFFS ALM_COMFAIL_SCHDOCC ALM_COMFAIL_DLC ALM_COMFAIL_TEMPRESET ALM_COMFAIL_ODTEMP ALM_COMFAIL_OCCSENSOR ALM_COMFAIL_WINDOW ALM_COMFAIL_MANHEAT ALM_COMFAIL_MANCOOL ALM_HW_SW_MISMATCH RETURN_TO_NORMAL RTN_NODE_OFF RTN_FROST RTN_INVALID_SETPNT RTN_TEMP_SENSOR_FAIL RTN_SETPNT_KNOB_FAIL RTN_FAN_SPEED_SW_FAIL RTN_FAN_FAILURE RTN_COMFAIL_SPACETEMP RTN_COMFAIL_HVACMODE	0 1 2 3 4 5 6 7 8 9 10 11 12 13 14 15 16 17 18 19 128 129 130 131 132 133 134 135 136 137	RETURN_TO_NORMAL (at application restart)	This output variable reports the latest changed error condition detected in the node. The first 5 bits are used for the alarm type number, and this number is added to RETURN_TO_NORMAL (128) when the error condition is no longer true. Each error condition/return-to-normal is issued only once. The type is also recorded in nvoAlarmLog and nvoFcuStatus.alarm_type. Alarm reporting is suppressed by setting nviManualMode to SUPPRESS_ALARMS, in which case nvoAlarm.type is set to ALARM_NOTIFY_DISABLED. Alarm reporting is turned ON again by setting nviManualMode to UNSUPPRESS_ALARMS, after which all existing alarms (or ALM_NO_ALARM) are reported one at a time.
nvoAlarm					

Table C4. Output Variables for Excel 10 FCU Controllers.

NV name	field name	engineering units: English (metric) or states plus range	digital state or value	default	comments
		RTN_COMFAIL_SETPTOFFS RTN_COMFAIL_SCHDOCC RTN_COMFAIL_DLC RTN_COMFAIL_TEMPRESSET RTN_COMFAIL_ODTEMP RTN_COMFAIL_OCCSENSOR RTN_COMFAIL_WINDOW RTN_COMFAIL_MANHEAT RTN_COMFAIL_MANCOOL RTN_HW_SW_MISMATCH ALARM_NOTIFY_DISABLED	138 139 140 141 142 143 144 145 146 147 255		
nvoAlarmLog	alarm_type[0]	Same as nvoAlarm.type		See nvoAlarm.type	A central node may poll this output variable for a short history of alarms. It contains the last five alarms reported via nvoAlarm. At the time a new nvoAlarm is issued, nvoAlarmLog is updated.
nvoAlarmLog	alarm_type[1]	Same as nvoAlarm.type		See nvoAlarm.type	See above.
nvoAlarmLog	alarm_type[2]	Same as nvoAlarm.type		See nvoAlarm.type	See above.
nvoAlarmLog	alarm_type[3]	Same as nvoAlarm.type		See nvoAlarm.type	See above.
nvoAlarmLog	alarm_type[4]	Same as nvoAlarm.type		See nvoAlarm.type	See above. nvoAlarmLog.alarm_type[4] is the oldest alarm.
nvoAlarmStatus	error_bit[0]	UBYTE Bit coded Alarm: ALM_NODE_OFF ALM_FROST ALM_INVALID_SETPNT ALM_TEMP_SENSOR_FAIL ALM_SETPNT_KNOB_FAIL ALM_FAN_SPEED_SW_FAIL ALM_FAN_FAILURE ALM_COMFAIL_SPACETEMP	1 2 4 8 16 32 64 128		This output variable is a polled output containing a list of all the current errors detected by the node. A search for error conditions in the node is made periodically. A central node may poll the nvoAlarmStatus output for all of the current errors. nvoAlarmStatus contains all the current detected errors even though they may be suppressed for reporting by nvoAlarm.
nvoAlarmStatus	error_bit[1]	UBYTE Bit coded Alarm: ALM_COMFAIL_HVACMODE ALM_COMFAIL_SETPTOFFS ALM_COMFAIL_SCHDOCC ALM_COMFAIL_DLC ALM_COMFAIL_TEMPRESSET ALM_COMFAIL_ODTEMP ALM_COMFAIL_OCCSENSOR ALM_COMFAIL_WINDOW	1 2 4 8 16 32 64 128		See above.

Table C4. Output Variables for Excel 10 FCU Controllers.

NV name	field name	engineering units: English (metric) or states plus range	digital state or value	default	comments
nvoAlarmStatus	error_bit[2]	UBYTE Bit coded Alarm: ALM_COMFAIL_MANHEAT ALM_COMFAIL_MANCOOL ALM_HW_SW_MISMATCH	1 2 4		See above.
nvoApplicMode		SNVT_hvac_mode HVAC_AUTO HVAC_HEAT HVAC_COOL HVAC_OFF	0 1 3 6	HVAC_OFF (at application restart)	This output variable is used to coordinate the slave devices with the master controller. It reflects the current heat/cool medium based upon the available supply energy. This is required for configurations with heat/cool changeover. HVAC_OFF switches the heat/cool control OFF while still providing frost protection and reporting status and alarms.
nvoCoolOutput		SNVT_lev_percent 0 to 100% 163.835% = INVALID			This output variable is the cooling output which is typically used for monitoring or bound to a cooling actuator node or another controller operating as slave. nvoCoolOutput will be transmitted immediately when its value has changed significantly ($\geq 1\%$), and periodically according to nciSndHrtBt. The output value represents the output of the control algorithm but is limited to a range of 0% to 100%.
nvoDigitInState	value	SNVT_switch.value 0 to 100%			This output variable indicates the binary state of the controller's digital input which can be configured to support a window contact, an occupancy/movement sensor, an air flow contact, or a heat/cool changeover contact. It can be bound to another Excel 10 controller or a third party node.
nvoDigitInState	state	SNVT_switch.state OFF ON NOT_ASSIGNED	0 1 255		See above.
nvoEffectOcc		SNVT_occupancy OC_OCCUPIED OC_UNOCCUPIED OC_BYPASS OC_STANDBY	0 1 2 3		This output variable reflects the effective occupancy mode derived from the time schedule, occupancy sensor, override button, and network occupancy override.
nvoFanSpeed	value	SNVT_switch.value 0 to 100%		0 (at application restart)	This output variable reports the fan speed for the controller. It can be bound to another Excel 10 controller with a fan connected or to a third-party fan node.
nvoFanSpeed	state	SNVT_switch.state OFF ON	0 1	NO_FAN (at application restart)	See above.

Table C4. Output Variables for Excel 10 FCU Controllers.

NV name	field name	engineering units: English (metric) or states plus range	digital state or value	default	comments
		NO_FAN	255		
nvoFanSpeedSw	value	SNVT_switch.value 0 to 100%			This output variable allows the fan speed switch of a master controller to be used for all slave Excel 10 controllers in the same room.
nvoFanSpeedSw	state	SNVT_switch.state OFF ON NO_FAN_SPEED_SW			See above.
nvoFcuStatus	field_no	UBYTE FIELD_EFFECT_OCC FIELD_HW_OVERRIDE FIELD_SCHED_OCC FIELD_EFF_SEN_OCC FIELD_NET_MAN_OCC FIELD_HW_SEN_OCC FIELD_R_O_LED FIELD_MODE FIELD_ALARM_TYPE FIELD_DLC_SHED FIELD_EFF_WINDOW_OPEN FIELD_HW_WINDOW_OPEN FIELD_FAN_FEEDBACK FIELD_EXTERNAL_ACTIVE FIELD_FAN_STAGES_ACTIVE FIELD_OUTPUT_POS_1 FIELD_OUTPUT_POS_2 FIELD_REHEAT_RELAY FIELD_ACTIVE_SET_PT FIELD_SPACE_TEMP FIELD_REST_BYPASS_TIME	1 2 3 4 5 6 7 8 9 10 11 12 13 14 15 16 17 18 19 20 21		This output variable is used to indicate which other data field in nvoFcuStatus has changed since the last time nvoFcuStatus was sent out on the network. If any field has had a significant change, only that field is updated, and field_no indicates which field. If three or more fields have changed significantly, then all fields are updated and field_no is set to 0. All fields are also updated every refresh time (55s).
nvoFcuStatus	effect_occ	SNVT_occupancy OC_OCCUPIED OC_UNOCCUPIED OC_BYPASS OC_STANDBY	0 1 2 3		This output variable is the effective occupancy mode resulting from scheduled occupancy mode, occupancy sensor information, bypass push-button, or manual operator interface.
nvoFcuStatus	hw_override	SNVT_occupancy OC_UNOCCUPIED OC_BYPASS OC_NUL (No Override)	1 2 255		This output variable reports the current state of the remote override button.

Table C4. Output Variables for Excel 10 FCU Controllers.

NV name	field name	engineering units: English (metric) or states plus range	digital state or value	default	comments
nvoFcuStatus	sched_occ	SNVT_occupancy OC_OCCUPIED OC_UNOCCUPIED OC_BYPASS OC_STANDBY OC_NUL (No Override)	0 1 2 3 255		This output variable reports the current scheduled occupancy received via the network.
nvoFcuStatus	eff_sen_occ	SNVT_occupancy OC_OCCUPIED OC_UNOCCUPIED OC_NUL (No Override)	0 1 255		This output variable reports the effective state of occupancy sensor(s) connected either to the input terminals or to other nodes on the network that are bound to this controller.
nvoFcuStatus	net_man_occ	SNVT_occupancy OC_OCCUPIED OC_UNOCCUPIED OC_BYPASS OC_STANDBY OC_NUL	0 1 2 3 255		This output variable reports the manual occupancy from the network.
nvoFcuStatus	hw_sen_occ	SNVT_occupancy OC_OCCUPIED OC_UNOCCUPIED OC_NUL	0 1 255		This output variable reports the state of the occupancy sensor wired to the node.
nvoFcuStatus	r_o_led	SNVT_occupancy OC_OCCUPIED OC_UNOCCUPIED OC_BYPASS OC_STANDBY OC_NUL	0 1 2 3 255		This output variable reports the current state of the remote override LED which indicates the effective schedule override resulting from the bypass push-button or a network override. OC_OCCUPIED: 2 flashes per second OC_UNOCCUPIED: 1 flash per second OC_BYPASS: on OC_STANDBY: 2 flashes per second OC_NUL: off
nvoFcuStatus (continued)	mode	BYTE CTL_COOL CTL_HEAT CTL_PRESSURIZE CTL_DE_PRESSURIZE CTL_MODE_MANUAL CTL_MODE_FACTORY_TEST CTL_FLOATING_OUT_SYNCH CTL_FAN_SWITCH_OFF CTL_START_UP_WAIT CTL_DISABLED	0 1 2 3 4 5 6 7 8 255		This output variable is the current operating mode of the node determined by many inputs and arbitrated by control logic. CTL_PRESSURIZE disables the heat/cool outputs, fan runs at highest speed. CTL_DE_PRESSURIZE disables the heat/cool outputs, fan is turned OFF. CTL_MODE_MANUAL allows turning outputs ON/OFF manually through nviTest. CTL_MODE_FACTORY_TEST is intended only for the factory. CTL_FLOATING_OUT_SYNCH allows enough time (150% valve run-time) for the valve(s) are at their initial positions (control algorithms are active). The controller then goes into one of the

Table C4. Output Variables for Excel 10 FCU Controllers.

NV name	field name	engineering units: English (metric) or states plus range	digital state or value	default	comments
nvoFcuStatus					normal operating modes, such as CTL_COOL. When the effective occupancy changes to unoccupied or 24 hours have elapsed since the last start-up or CTL_FLOATING_OUT_SYNCH mode, the controller enters this mode again to reset the floating output position tracking. CTL_START_UP_WAIT is the first mode after an application restart. No control algorithms are active, and heat/cool outputs stay in their default positions. CTL_FLOATING_OUT_SYNCH follows. CTL_DISABLED disables heat/cool control.
nvoFcuStatus	alarm_type	Same as nvoAlarm.type			This output variable is the latest alarm detected by the node (if any) and has the same value as nvoAlarm.type.
nvoFcuStatus	dlc_shed	Bit NOT_ACTICE ACTIVE	0 1		This output variable indicates the state of the demand limit control.
nvoFcuStatus	eff_window_open	Bit CLOSED or NOT_ASSIGNED OPEN	0 1		This output variable indicates the real status of the window detection, either from the digital input or from the network.
nvoFcuStatus	hw_window_open	Bit CLOSED or NOT_ASSIGNED OPEN	0 1		This output variable indicates the status of the digital input configured as a window contact.
nvoFcuStatus	fan_feedback	Bit FAN_OFF_AFTER_ON_CMD FAN_RUNS	0 1		This output variable indicates the status of the fan when the digital input is configured for an air flow sensor.
nvoFcuStatus	external_active	Bit EXTERNAL_NOT_ACTICE EXTERNAL_ACTIVE	0 1		This output variable applies to nciFcuConfig.reheat_config = EXTERNAL only and indicates the state of the relay.
nvoFcuStatus	fan_stages_active	UBYTE F_OFF F_SPEED1 F_SPEED2 F_SPEED3 F_NO_FAN	0 1 2 3 255		When the controller is configured for one or more fan stages, this output variable reports the current fan stage active.
nvoFcuStatus	output_position[0]	SNVT_lev_percent 0 to 100% 163.835% = INVALID			This output variable indicates the position of the output 1.
nvoFcuStatus	output_position[1]	SNVT_lev_percent			This output variable indicates the position of the output 2.

Table C4. Output Variables for Excel 10 FCU Controllers.

NV name	field name	engineering units: English (metric) or states plus range	digital state or value	default	comments
		0 to 100% 163.835% = INVALID			
nvoFcuStatus	reheat_active	SNVT_lev_disc ST_OFF ST_ON ST_NUL (No Reheat)	0 4 255		This output variable reports the current state of the reheat output, when the controller is configured for one.
nvoFcuStatus	active_set_pt	SNVT_temp_p 50 to 95°F (10 to 35°C) 621.806°F (327.67°C) = INVALID			This output variable reports the current temperature control point calculated from the various setpoints, operating modes, and optimum start-up gradients.
nvoFcuStatus	space_temp	SNVT_temp_p 0 to 104°F (0 to 40°C) 621.806°F (327.67°C) = INVALID			This output variable reports the current space temperature used for the control algorithm.
nvoFcuStatus	rest_bypass_time	UWORD 0 to 65535 Min			This output variable shows the current value in minutes of the active bypass timer
nvoFcuStatusP	field_no	Same as nvoFcuStatus.			This output variable is the same as nvoFcuStatus except not sent as heartbeat. This variable is sent only in response to a poll request, typically from a supervisory device.
nvoFcuStatusP	effect_occ	Same as nvoFcuStatus.			Same as nvoFcuStatus.
nvoFcuStatusP	hw_override	Same as nvoFcuStatus.			Same as nvoFcuStatus.
nvoFcuStatusP	sched_occ	Same as nvoFcuStatus.			Same as nvoFcuStatus.
nvoFcuStatusP	eff_sen_occ	Same as nvoFcuStatus.			Same as nvoFcuStatus.
nvoFcuStatusP	net_man_occ	Same as nvoFcuStatus.			Same as nvoFcuStatus.
nvoFcuStatusP	hw_sen_occ	Same as nvoFcuStatus.			Same as nvoFcuStatus.
nvoFcuStatusP	r_o_led	Same as nvoFcuStatus.			Same as nvoFcuStatus.
nvoFcuStatusP	mode	Same as nvoFcuStatus.			Same as nvoFcuStatus.
nvoFcuStatusP	alarm_type	Same as nvoFcuStatus.			Same as nvoFcuStatus.
nvoFcuStatusP	dlc_shed	Same as nvoFcuStatus.			Same as nvoFcuStatus.
nvoFcuStatusP	eff_window_open	Same as nvoFcuStatus.			Same as nvoFcuStatus.
nvoFcuStatusP	hw_window_open	Same as nvoFcuStatus.			Same as nvoFcuStatus.
nvoFcuStatusP	fan_feedback	Same as nvoFcuStatus			Same as nvoFcuStatus.

Table C4. Output Variables for Excel 10 FCU Controllers.

NV name	field name	engineering units: English (metric) or states plus range	digital state or value	default	comments
nvoFcuStatusP	external_active	Same as nvoFcuStatus			Same as nvoFcuStatus.
nvoFcuStatusP	fan_stages_active	Same as nvoFcuStatus			Same as nvoFcuStatus.
nvoFcuStatusP	output_position[0]	Same as nvoFcuStatus.			Same as nvoFcuStatus.
nvoFcuStatusP	output_position[1]	Same as nvoFcuStatus.			Same as nvoFcuStatus.
nvoFcuStatusP	reheat_active	Same as nvoFcuStatus			Same as nvoFcuStatus.
nvoFcuStatusP	active_set_pt	Same as nvoFcuStatus.			Same as nvoFcuStatus.
nvoFcuStatusP	space_temp	Same as nvoFcuStatus.			Same as nvoFcuStatus.
nvoFcuStatusP	rest_bypass_time	Same as nvoFcuStatus.			Same as nvoFcuStatus.
nvoHeatOutput		SNVT_lev_percent 0 to 100% 163.835% = INVALID			This output variable is the heating output which is typically used for monitoring or bound to a heat actuator node or another Excel 10 controller operating as slave. nvoHeatOutput will be transmitted immediately when its value has changed significantly (>= 1%), and periodically according to nciSndHrtBt. The output value represents the output of the control algorithm but is limited to a range of 0% to 100%.
nvoReheat	value	SNVT_switch.value 0 to 100%			This output variable reports the actual state of the reheat output. It can be bound to another Excel 10 controller acting as a slave, or it can be bound to a third-party reheat node.
nvoReheat	state	SNVT_switch.state OFF ON NO_REHEAT	0 1 2		See above.
nvoSensor	override_button	Bit NOT_PRESSED PRESSED	0 1		This output variable indicates the status of the override push-button.
nvoSensor	contact_state_DI1	Bit CONTACT_OPEN CONTACT_CLOSED	0 1		This output variable indicates the state of the digital input.
nvoSensor	raw_data[0]	UWORD 0 to 65535			This output variable contains the analog to digital converter count measured from the analog value of the temp. sensor, which represents the measured time during the second part of each A/D conversion.
nvoSensor	raw_data[1]	UWORD 0 to 65535			Same as above for the fan speed switch.
nvoSensor	raw_data[2]	UWORD			Same as above for the setpoint knob.

Table C4. Output Variables for Excel 10 FCU Controllers.

NV name	field name	engineering units: English (metric) or states plus range	digital state or value	default	comments
		0 to 65535			
nvoSensor	fan_speed_switch	SNVT_lev_disc ST_OFF ST_LOW ST_MED ST_HIGH ST_NUL (No Switch)	0 1 2 3 255		This output variable indicates the position of the fan speed switch ON the wall module.
nvoSensor	remote_set_point	SNVT_temp_p -9 to 9 DDF (-5 to 5 K) for relative 53.6 to 86°F (12 to 30°C) for absolute			This output variable is the setpoint from the wall module setpoint knob and may be absolute or relative depending upon nciWallMod.set_pnt_knob.
nvoSensor	space_temp	SNVT_temp_p 0 to 104°F (0 to 40°C) 621.806°F (327.67°C) = INVALID			This output variable is the measured space temperature.
nvoSensor	ub_hard_config	BYTE INITIAL W7752D, F W7752E, G INVALID	0 4 5 255	INITIAL (at application restart)	This output variable is used to establish hardware-dependent factory default configuration settings for the Fan Coil Unit controller. Note that D and F versions and E, G and J versions differ only in their supply voltage.
nvoSensorOcc		SNVT_occupancy OC_OCCUPIED OC_UNOCCUPIED OC_NUL (No Sensor)	0 1 255	OC_NUL (at application restart)	This output variable shows the state of the locally-wired occupancy sensor, if one is configured by nciFcuConfig.DI1_config. OC_NUL means no input is available because it is not bound or not configured by nciFcuConfig.DI1_config.
nvoSpaceTemp		SNVT_temp_p 0 to 104°F (0 to 40°C) 621.806°F (327.67°C) = INVALID		INVALID (at application restart)	This output variable is the sensed space temperature at the node taken from the locally-wired sensor. It is typically bound to nviSpaceTemp of another node which may not have its own space temperature sensor but controls the same space. It is also used for monitoring purposes, showing the current space temperature used for the control algorithm. nvoSpaceTemp is transmitted immediately when its value has changed significantly (> 0.5 delta°C). The reported space temperature includes the offset correction nciWallMod.si_space_temp_zero_cal. If a space temperature sensor is not connected or is shorted or if

Table C4. Output Variables for Excel 10 FCU Controllers.

NV name	field name	engineering units: English (metric) or states plus range	digital state or value	default	comments
					nviSpaceTemp is bound to another node, nvoSpaceTemp is not reported on the network.
nvoStatus	object_id	UWORD NODE_OBJECT FCU_OBJECT	0 1		This output variable belongs to the Node Object and reports the status for any object on a node. This is the answer to the nviRequest.
nvoStatus	invalid_id	Bit VALID_ID INVALID_ID	0 1		This output variable indicates whether nviRequest uses a fault object ID.
nvoStatus	invalid_request	Bit VALID_REQUEST INVALID_REQUEST	0 1		This output variable indicates whether nviRequest uses a fault request.
nvoStatus	disabled	Bit ENABLED DISABLED	0 1		This output variable indicates whether the device is enabled or disabled (nviManualMode = DISABLE).
nvoStatus	comm_failure	Bit COMMUNICATION_OK COMMUNICATION_FAILURE	0 1		This output variable indicates whether an update nviRcvHrtBt is missing.
nvoStatus	in_alarm	Bit NO_ALARM IN_ALARM	0 1		This output variable indicates whether an alarm occurred. See nvoAlarm.
nvoStatus	report_mask	Bit NO_REPORT_MASK REPORT_MASK	0 1		This output variable shows the answer to nviRequest > REPORT_MASK
nvoTerminalLoad		SNVT_lev_percent -163..163% 163.835% = INVALID			This output variable shows the terminal load, which is a percentage between -160% and +160% based upon the control output level. Negative values indicate heating load and positive values indicate cooling load. 100% is the full terminal capacity. An absolute terminal load value of more than 100% indicate that the terminal is not able to supply the required heating or cooling energy which at the zone controller should cause a demand for more supply energy. nvoHeatOutput will be transmitted immediately when its value has changed significantly (>= 1%).
nvoUnitStatus	mode	SNVT_hvac_mode HVAC_HEAT HVAC_COOL HVAC_OFF	1 3 6		This output variable reports the last operating mode of the control algorithm. It is not set to HVAC_OFF if the Heating and Cooling Output shows 0%. HVAC_OFF is set when the Device is disabled from nviRequest, nviManualMode or nviApplicMode.

Table C4. Output Variables for Excel 10 FCU Controllers.

NV name	field name	engineering units: English (metric) or states plus range	digital state or value	default	comments
nvoUnitStatus	heat_output_primary	SNVT_lev_percent 0 to 100% 163.835% = INVALID			This output variable reports the actual heating output value. Any change forces nvoUnitStatus to be transmitted immediately.
nvoUnitStatus	heat_output_secondary	SNVT_lev_percent 0 to 100% 163.835% = INVALID			This output variable reports the reheat output value.
nvoUnitStatus	cool_output	SNVT_lev_percent 0 to 100% 163.835% = INVALID			This output variable reports the actual cooling output value. A change of more than 1% forces nvoUnitStatus to be transmitted immediately.
nvoUnitStatus	fan_output	SNVT_lev_percent 0 to 100%			This output variable reports the actual fan speed level.
nvoUnitStatus	in_alarm	UBYTE NO_ALARM ALARM ALARM_NOTIFY_DISABLED	0 1 255		This output variable reports the actual alarm status of the controller and is set to ALARM_NOTIFY_DISABLE when nviManualMode = SUPPRESS_ALARMS.
nvoWindow	value	SNVT_switch.value 0 to 100%		0 (at application restart)	This output variable reports the status of the window sensor. It allows the locally-wired window sensor to be used by other nodes on the network.
nvoWindow	state	SNVT_switch.state CLOSED OPEN NO_WINDOW	0 1 255	NO_WINDOW (at application restart)	See above.
nroPgmVer	id[0]	UBYTE, 70 = F			This output variable identifies the Excel 10 node type by an eight byte constant describing the node type, major and minor functional release number and bug fix. First character.
nroPgmVer	id[1]	UBYTE, 67 = C			Second character.
nroPgmVer	id[2]	UBYTE, 85 = U			Third character.
nroPgmVer	id[3]	UBYTE, 50 = 2			Fourth character.
nroPgmVer	major_ver	UBYTE, 0 to 255			Major Functional Release Number: 1. Add or delete a network variable (NV), nv field. 2. Change the name of a nv or nv field. 3. Range or type (short / long) of data in a nv field is changed. 4. Enumerated value list of a nv field is changed. NOTE: Algorithm changes or bug fixes may also be included.
nroPgmVer	minor_ver	UBYTE, 0 to 255			Minor Functional Release Number:

Table C4. Output Variables for Excel 10 FCU Controllers.

NV name	field name	engineering units: English (metric) or states plus range	digital state or value	default	comments
(continued) nroPgmVer					<ol style="list-style-type: none"> 1. Network variables are unchanged. 2. Functionality of the control algorithm has been revised and affects compatibility with other nodes or the equipment being controlled. 3. The network interface or physical input / output subsystem was revised and affects compatibility with other nodes. NOTE: Bug fixes may also be included in a minor functional release.
nroPgmVer	bug_ver	UBYTE, 0 to 255			Bug Fix Number: Network variables are unchanged. A change to the algorithm, network interface, or physical input/output subsystem was made that does not affect compatibility with other nodes or the equipment controlled by the node.
nroPgmVer	node_type	UBYTE, 10 = FCU2			Node type number.

Table C5. Unused Variables for Excel 10 FCU Controllers

NV name	field name	engineering units: English (metric) or states plus range	digital state or value	default	comments
nciAppVer	not_used1	UBYTE			Reserved for future use.
nciAppVer	not_used2	UBYTE			Reserved for future use.
nciCntrlSettings	reserve	7 bits			Reserved for future use.
nciFcuConfig	not_used	4 bits			Reserved for future use.
nciWallMod	spare_field[0]	UBYTE			Reserved for future use.
nciWallMod	spare_field[1]	UBYTE			Reserved for future use.
nvoFcuStatus	not_used	3 bits			Not used.
nvoFcuStatus	spare_field[0]	WORD			Not used.
nvoFcuStatusP	not_used	Same as nvoFcuStatus			Not used.
nvoFcuStatusP	spare_field[0]	Same as nvoFcuStatus			Not used
nvoSensor	not_used	6 bits			Reserved for future use.
nvoStatus	out_of_limits	Bit			Not supported
nvoStatus	open_circuit	Bit			Not supported
nvoStatus	out_of_service	Bit			Not supported
nvoStatus	mechanical_fault	Bit			Not supported
nvoStatus	feedback_failure	Bit			Not supported
nvoStatus	over_range	Bit			Not supported
nvoStatus	under_range	Bit			Not supported
nvoStatus	electrical_fault	Bit			Not supported
nvoStatus	unable_to_measure	Bit			Not supported
nvoStatus	fail_self_test	Bit			Not supported
nvoStatus	self_test_in_progress	Bit			Not supported
nvoStatus	Lock ed_out	Bit			Not supported
nvoStatus	manual_control	Bit			Not supported
nvoStatus	in_override	Bit			Not supported
nvoStatus	reserved1	Bit			Not supported
nvoStatus	reserved2	Bit			Not supported
nvoUnitStatus	econ_output	SNVT_lev_percent			Not supported

Honeywell

Manufactured for and on behalf of the Environmental and Combustion Controls Division of Honeywell Technologies Sàrl, Rolle, Z.A. La Pièce 16, Switzerland by its Authorized Representative:

Automation and Control Solutions

Honeywell GmbH
Böblinger Strasse 17
71101 Schönaich
Germany

Phone: (49) 7031 63701
Fax: (49) 7031 637493

<http://ecc.emea.honeywell.com>

Subject to change without notice. Printed in Germany

EN2B-0285GE51 R0909