

Congratulazioni per aver acquistato il rasaerba AMBROGIO 3000. L'aver scelto questo prodotto potrà soddisfare le vostre esigenze e aspettative. Questo progetto nasce da ZUCCHETTI CENTRO SISTEMI S.p.A. (Azienda certificata UNI EN ISO 9001) software house che, dal 1982, ha consolidato la propria attività e la propria presenza sul mercato internazionale. Le soluzioni applicative del software abbinate al settore industriale di automazione, fanno nascere prodotti nuovi che ottimizzano le procedure di lavoro. È così che è nato, dai laboratori di ricerca, AMBROGIO 3000.

Congratulations for having purchased the AMBROGIO 3000 lawn mower. This choice will surely meet your needs and expectations. This product is the result of research at the ZUCCHETTI CENTRO SISTEMI S.p.A. (certified UNI EN ISO 9001) software house that, since 1982, has been consolidating its role on the international market. Innovative software solutions applied to the industrial automation sector introduce new products that optimise working procedures. AMBROGIO 3000 was developed on the basis of this research.

Tous nos compliments pour avoir acheté la tondeuse à gazon AMBROGIO 3000. Vous avez choisi un produit qui répondra à vos besoins et à vos attentes. Ce projet naît au ZUCCHETTI CENTRO SISTEMI S.p.A. (Entreprise certifiée UNI EN ISO 9001) software house qui, depuis 1982, a consolidé son activité et sa présence sur le marché international. Les solutions d'application du logiciel, jumelées au secteur industriel d'automatisation, ont permis la naissance de nouveaux produits qui optimisent les procédures de travail. C'est ainsi que, dans nos laboratoires de recherche, est né AMBROGIO 3000.

Wir gratulieren zum Kauf des Rasenmähers AMBROGIO 3000. Ihre Bedürfnisse und Erwartungen werden durch die Wahl dieses Produkts mit Sicherheit erfüllt. Die Firma ZUCCHETTI CENTRO SISTEMI S.p.A. (mit UNI EN ISO 9001 ausgezeichnete Betrieb) Software House, die ihre Produktion seit 1982 festigt und damit auf dem internationalen Markt vertreten ist, zeichnet für dieses Produkt verantwortlich. Die angewandten Softwarelösungen führen in Kombination mit der industriellen Automatisierung zur Entstehung neuer Produkte für eine Optimierung von Arbeitsprozessen. Auf diese Weise entstand in den Forschungslabors AMBROGIO 3000.

Felicidades por haber adquirido la cortadora de césped AMBROGIO 3000. Podrá satisfacer sus exigencias y expectativas al haber elegido este producto. Este producto nace de ZUCCHETTI CENTRO SISTEMI S.p.A. (Empresa certificada UNI EN ISO 9001) software house que, desde 1982, ha consolidado su propia actividad y su propia presencia en el mercado internacional. Las soluciones de aplicación del software combinadas con el sector industrial de automatización, hacen nacer nuevos productos que optimizan los procedimientos de trabajo. Es así que ha nacido, en los laboratorios de investigación, Ambrogio 3000.

Wij wensen u van harte geluk met de aanschaf van uw AMBROGIO 3000. Wij zijn er zeker van dat deze machine voldoet aan al uw verwachtingen en vereisten. AMBROGIO 3000 is een project van ZUCCHETTI (met UNI EN ISO 9001 certificaties), een softwarebedrijf dat sinds 1982 met haar activiteiten een eigen plaats verwerf op de internationale markt. De combinatie van de oplossingen die worden geboden door softwaretoepassingen en de industriële automatisering resulteert in nieuwe producten om de bedrijfsprocessen te optimaliseren. Zo ontstond in onze onderzoekscentra Ambrogio 3000.

Manuale d'uso

Rasaerba Robot

Italiano

I

User's manual

Lawn Mower Robot

English

GB

Manuel d'utilisation

Tondeuse à gazon Robot

Français

F

Bedienungshandbuch

Rasenmäheroboter

Deutsch

D

Manual de uso

Cortadora de césped Robot

Español

E

Gebruiksaanwijzingen

Grasmaaimachine

Nederlands

NL

Dichiarazione di conformità (98/37 CE allegato II punto A)
ZUCCHETTI Centro Sistemi S.p.A. Via dell'Olmo 99 A/B Terranuova B.ni (AR) ITALIA, dichiara che la macchina, identificabile dai dati riportati in calce, da utilizzare per rasare prati in ambienti domestici e non, è conforme alle direttive: 98/37 CE - 78/23 CEE - 89/336 CEE. Per queste ultime sono compresi i successivi emendamenti.

Konformitätsbestätigung (98/37 CE Beilage II Punkt A)
Die Firma ZUCCHETTI Centro Sistemi S.p.A., Via dell'Olmo 99 A/B Terranuova B.ni (AR) ITALIEN, erklärt, daß die mit den unten angegebenen Daten gekennzeichnete Maschine, die dazu bestimmt ist, zum Mähen von Rasenflächen in Wohn- und anderer Umgebung eingesetzt zu werden, folgenden Richtlinien entspricht: 98/37 CE - 78/23 CEE - 89/336 CEE. Letztere schließen nachfolgende Abänderungen mit ein.

Declaration of conformity (98/37 CE annex II paragraph A)
ZUCCHETTI Centro Sistemi S.p.A., Via dell'Olmo 99 A/B Terranuova B.ni (AR) ITALY, declares that the machine, identified by the data included hereafter, to be used for lawn mowing in household and other environments, complies with directives: 98/37 EC - 78/23 EEC - 89/336 EEC and amendments thereto.

Declaración de conformidad (98/37 CE anexo II punto A)
ZUCCHETTI Centro Sistemi S.p.A. Via dell'Olmo 99 A/B Terranuova B.ni (AR) ITALIA, declara que la máquina, que se puede identificar por los datos al pie de la página, y que tiene como uso cortar prados tanto en ambientes domésticos como no domésticos, es conforme a las directivas: 98/37 CE - 78/23 CEE - 89/336 CEE. Para estas últimas están incluidas las enmiendas sucesivas.

Déclaration de conformité (98/37 CE annexe II paragraphe A)
ZUCCHETTI Centro Sistemi S.p.A. Via dell'Olmo 99 A/B Terranuova B.ni (AR) ITALIE, déclare que la machine, identifiable par les données rapportées plus bas, servant à tondre les pelouses en milieu domestique et non, est conforme aux directives : 98/37 CE - 78/23 CEE - 89/336 CEE. Pour ces dernières, sont inclus les amendements additionnels.

Verklaring van overeenstemming (98/37 EG bijlage II punt A)
ZUCCHETTI Via dell'Olmo 99 A/B Terranuova B.ni (AR) ITALIA, verklaart dat de machine waarvan de identificatiegegevens hiernaast worden vermeld en die bedoeld is om gras te maaien in huishoudelijke en andere omgevingen, voldoet aan de richtlijnen: 98/37 EG - 78/23 EEG - 89/336 EEG. In de laatste richtlijnen zijn ook de latere wijzigingen inbegrepen.

Modello/serie - Model/Series
Modèle/série - Modell/Serie
Modelo/serie - Model/serie

Bernini Fabrizio
(Amministratore delegato) - (Managing director)
(Administrateur délégué) - (Geschäftsführer)
(Administrador delegado) - (Afgvaardigd beheerder)

.....

CONTENTS

GENERAL INFORMATION	4
TECHNICAL INFORMATION	5
SAFETY INFORMATION	7
INSTALLATION	9
OPERATING INSTRUCTIONS	18
MAINTENANCE INFORMATION	27
TROUBLE SHOOTING	31

ANALYTICAL CONTENTS

A Adjustment, cutting height, 20 Adjustment, mower balance, 20 Area without perimeter cable and without garage, work, 22	Programming procedure, 23 Purpose of the manual, 4
B Battery recharging with winter recharging kit, 30	
C Checking the cutting disc, 28 Clamps and contact plates, 28 Cleaning and maintenance of the mower, 27 Control, cutting disc, 28 Cutting disc - replacement, 28 Cutting height - setting, 20	R Rain sensor adjustment, 21 Rain sensor, settings, 26 Rapid return to garage, settings, 15 Recharging base cleaning, 27 Remote control use, 27 Replacement, cutting disc, 28 Replacing the batteries, 29 Resumption for work after storage, 30
D Date and time, settings, 24 Description of keyboard controls, 18 Display, description, 19	S Safety signals, 9 Secondary settings, 25 Separate closed areas, work, 22 Service procedure, 5 Set Date and Time, 24 Set Language, 24 Set Password, 26 Set Perimeter, 26 Set Rain Sensors, 26 Set working schedule, 24 Setting the rapid return to the recharging base, 15 Starting, 19 Stop, 19 Storage, restarting work after, 30
E Emergency stop, 19	
G Garage transformer, installation, 16 Garage, perimeter cable connections, 16 General machine description, 5 General safety, 7 General suggestions, 21 General warnings, 8	T Technical specifications, 7
I Identification of manufacturer and appliance, 4 Installation of transformer and recharging base, 16 Installation procedure, 9	U Unpacking, packaging and, 9
K Keyboard, control descriptions, 18	W Winter recharging Kit, battery recharging, 30 Work area without perimeter cable and automatic return, 14 Work area without perimeter cable and manual return, 15 Work area, preparation, 9 Work in areas without perimeter cable or recharging base, 22 Work in separate closed areas, 22 Work in small areas without perimeter cable and with the presence of an operator, 22 Working area settings, 9 Working area with perimeter cable, 11 Working hours, settings, 24 Working phase commands, 20
L Language selection, settings, 24 Lawn mower balancing- adjustment, 20 Lawn mower storage, 30	
M Machine, general description, 5 Machine, manufacturer's identification and, 4 Manual, purpose of, 4	
O Optionals, 7	
P Packaging and unpacking, 9 Password, settings, 26 Perimeter cable - recharging base connection, 16 Perimeter cable, work area with, 11 Perimeter, settings, 26 Problems, causes, solutions, 31	

PURPOSE OF THE MANUAL

The constructor has produced this manual, which forms an integral part of the appliance, to provide the necessary information for those authorised to interact with it during its working life.

As well as adopting good practices for use, the manual's intended readers must read it thoroughly and apply its instructions to the letter. The constructor supplies this information in its own language (Italian), but it may be translated into other languages to meet legal and/or commercial requirements. A little time taken to read this information will allow the prevention of risks to health and safety, and the risk of economic losses. Keep this manual in a clearly identified safe place throughout the working life of the appliance, so that it will always be available when required for consultation. The constructor reserves the right to make changes without any obligation to provide any prior notice.

A number of symbols have been used to highlight particularly important parts of the text or important specifications. Their meaning is as defined below.



Danger - Attention

Indicates critically dangerous situations that, if neglected, can result in serious personal safety and health hazards.



Warning - Caution

Indicates that suitable procedures must be adopted to avoid putting people's health and safety at risk or causing economic losses.



Important

Indicates particularly important technical information which must not be overlooked.

IDENTIFICATION OF MANUFACTURER AND APPLIANCE

The dataplate shown here is fitted directly to the appliance. It features references and all essential information for operating safety.

- A) Manufacturer identification.
- B) CE conformity label.
- C) Serial model/number year of construction.
- D) Technical specifications.

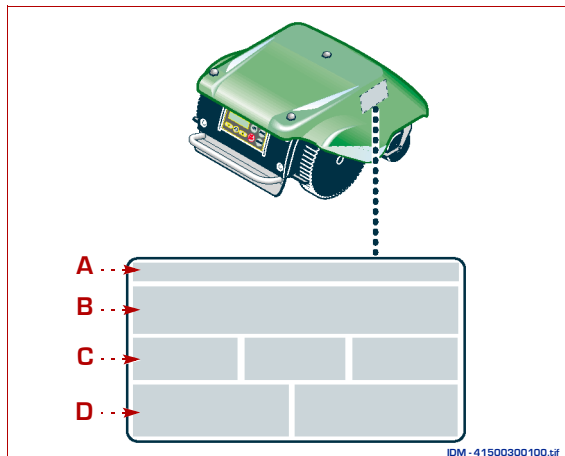

SERVICE PROCEDURE

Please refer to the Manufacturer's service centres for any need.

For every technical service request regarding the machine, please indicate the

data found on the identification plate, the approximate hours of use and the type of fault detected.

TECHNICAL INFORMATION

GENERAL MACHINE DESCRIPTION

This machine is a robot that automatically mows the grass in your garden.

It is small, compact, silent and easy to transport.

It can freely move within an enclosed area, detecting the signal transmitted by the perimeter cable located on the ground all around the area to be mowed; it can also work without a perimeter cable as long as the working area is enclosed by a fence at least 10 cm. high.

When work autonomy has expired [see technical specifications], the robot returns to the base to automatically recharge the batteries. When this operation is over, the machine restarts mowing.

It follows a "random" pattern, with no fixed plan; periodically and randomly, the spiral function, particularly efficient on obstacle free areas, is activated.

It covers an area of up to 3000 m²; two or more robots can work simultaneously to cover a wider area.

According to the various operating requirements, the robot can be produced in several models whose differences are indicated in the technical specifications.

It is equipped with a keyboard with a user-friendly and easy-to-program display. It can operate day and night; only working time start and finish including work days for intended use need to be

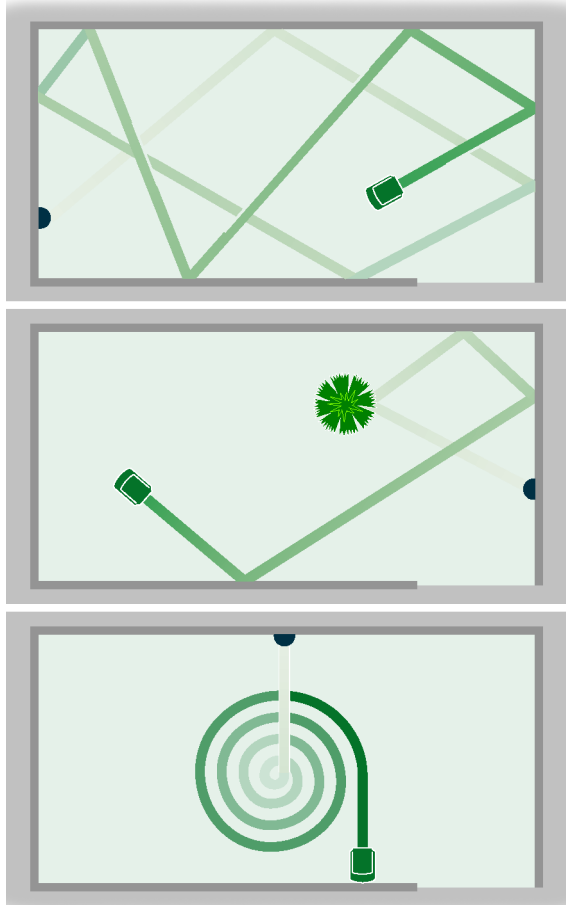

C1415 00900.fm

IDM - 41500300200.tif

set.

If the lawn mower is lifted or overturned the blade stops to prevent hazards to people and/or pets.

It is fully water-resistant and can therefore operate in all weather conditions.

The grass in your garden will always be at the desired height, to guarantee an even lawn all year round.

Important

It is not water-proof therefore it must not be submerged under water.

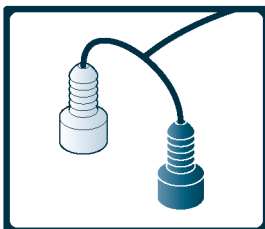

Winter recharge Kit (optional): to recharge or keep batteries charged without using the garage.

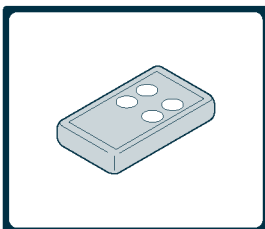

Remote control (DELUXE model only): permits the machine to be used in manual mode.

Transformer with cable: supplies the recharging base.

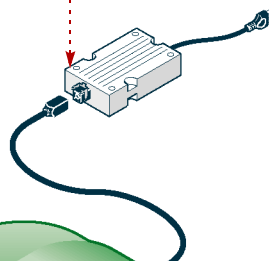

Recharging base: where the lawn mower is placed when it needs to be recharged.

Protection cover: allows reaching internal components.

Batteries: guarantee a specific working range (see technical data).

Contact devices: provide connection to the base for recharging.

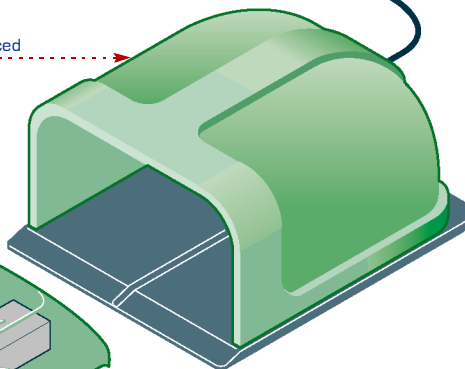

Cutting disc with 4 blade: reversible

Pivoting front wheels

Keyboard for programming and setup.

Driving wheels: they drive the lawn mower, powered by electrical motors.

Electronic card with microprocessor for function control.

Handle: to lift and move the lawn mower.

Supporting frame: supports all main components of the lawn mower.

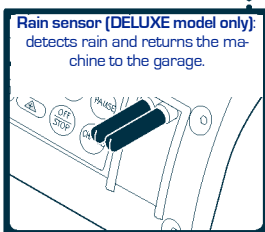

Rain sensor (DELUXE model only): detects rain and returns the machine to the garage.

Nails pocket: to fix the perimeter cable and the recharging base to the ground.

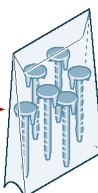

Low voltage perimeter cable: to be fixed to the ground or underground to delimit the working area.

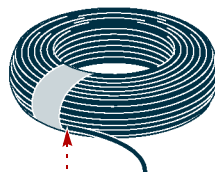

IDM - 41500900100.tif

C14-15-00900_fm

TECHNICAL SPECIFICATIONS

	PROFESSIONAL	DELUXE
Cutting disc	with 4 blades	
Cutting speed	20 m/min	
Cutting height	2÷7 cm	
Cutting width	30 cm	
Maximum coverage	3000 m ²	
Average coverage	125 m ² <i>(for each programmed hour)</i>	
Working range	1 ÷ 1 hours and 30 min (approximate)	
Size	57 x 42 x 26 (mm)	
Total weight (without batteries)	9,5 Kg	
Lead batteries (2)	12 V/ 12 Ah	
Recharging base	24 V/3,5 A	
Transformer	110/220 V (double insulation)	
Perimeter cable [*]	ø min 1.5 mm / l = 150 meters	
Remote control	NO	YES
Rain sensor	NO	YES
Recharge for winter storage	NO	YES

GB

OPTIONALS

- lithium battery
- recharge for winter garaging

[*] If the chosen installation requires cables laid underground, a suitable cable must be used. Consult your dealer or the manufacturer.

SAFETY INFORMATION

GENERAL SAFETY



Important

Safety information, general indications and notes to be considered when using the machine are mentioned below. It is understood that this does not exempt the user from reading the entire manual.

- During design and construction, the manufacturer has carefully considered the possible hazards and personal risks that may result from interaction with the machine. In addition to observing the specific laws in

force, the manufacturer has adopted all "exemplary construction technique principles". The purpose of this information is to advise the users to use extreme caution to avoid risks. However, discretion is invaluable. Safety is also in the hands of all the operators who interact with the machine.

- Carefully read the instructions published in the supplied manual and found directly on the machine while strictly observing those concerning safety. Time dedicated to reading will prevent unfortunate accidents; re-

remembering what one was supposed to do when the damage is already done is always too late.

- **Pay attention** to the meanings of the symbols on the applied stickers; their shape and colour are significant to safety ends. Keep them legible and observe the indicated information.
- **Never tamper, dodge, eliminate or bypass** the safety devices installed on the machine. Neglect to respect this requirement may cause serious risk to personal safety and health.
- **Personnel who are to perform any type of work on the machine during its lifetime must possess specific technical skills, abilities and have acquired certified experience in the specific field.** Neglect to observe these requirements may prove hazardous to personal safety and health.
- **When using the machine, make sure there are no risks especially for children, pets and things.**
- **Perform lifting and handling observing**

the information found directly on the packaging, on the machine and in the instructions furnished by the manufacturer.

- **Only use the machine for the purposes specified by the manufacturer.** Use of the machine for other purposes may be hazardous to personal safety and health and provoke economic loss.
- **All maintenance procedures that require precise technical competency or specific skills must be exclusively performed by qualified personnel with acquired certified experience in the specific field.**
- **Replace deteriorated parts with originals to ensure functionality and the foreseen safety level.**
- **Do not litter the environment with pollutant material; perform disposal according to the pertinent laws in force.**
- **Do not place hands or feet under the machine when running especially in the wheel area.**

GENERAL WARNINGS

- **The lawn mower may be used only by those who know how to operate it after reading and understanding the instructions in this manual.**
- **Before using the lawn mower make sure that no objects are on the lawn (toys, tree branches, items of clothing, etc.).**
- **Keep the lawn mower in perfect operating conditions by performing the maintenance procedures outlined by the manufacturer.** Good maintenance guarantees better performance and longer service life.
- **Before maintenance and setting procedures are performed – also by the user, if possessing the necessary**

technical skills – disconnect the power supply. **The user must in any case operate in full safety conditions, especially when working on the lower part of the lawn mower, following the procedures as illustrated by the manufacturer.**

- **All interventions on the recharging base must be performed after disconnecting the power supply.**
- **Use personal protections as recommended by the manufacturer, especially the protective gloves when handling blades and cutting discs.**
- **Always remove the blade before replacing the batteries.**

C1415100900.fm

SAFETY SIGNALS



Safety signal: indicates that the user should carefully read the manual before operating the lawn mower.



Prohibiting signal: indicates that the lawn mower should not be used in the presence of children and/or pets.



Danger signal: indicates that the user should not approach to the blades while the lawn mower is operating.

INSTALLATION

GB

PACKAGING AND UNPACKAGING

The machine is delivered suitably packaged. When unpacking, remove carefully and check component integrity.

All the necessary information for handling is found on the packaging.



Important

Keep the packaging for future usage.

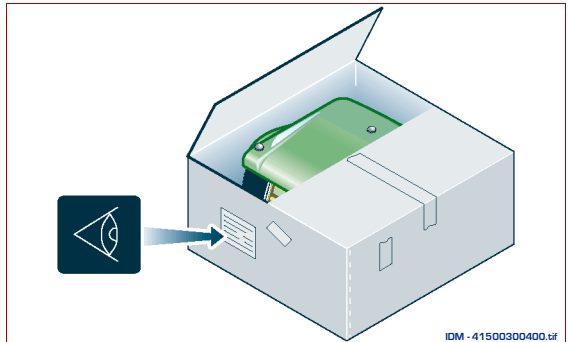

INSTALLATION PROCEDURE

Installation procedures depend on the working area to be covered, for this reason the chapter is divided into the following paragraphs:

- 1) working area settings (p. 9)
 - working area with perimeter cable (p. 11)
 - Work area without perimeter cable and automatic return (p. 14)
 - Work area without perimeter cable and manual return (p. 15)

- 2) transformer and recharging base installation (p. 16)
- 3) perimeter cable - recharging base connection (p. 16)



Important

Rigorously respect indicated procedures, since an incorrect installation limits the quality of lawn mower operations.

Working area settings

Prior to installation, all obstacles or irregularities that could obstruct lawn mower movements need to be considered, and, if necessary, protected as indicated in the following paragraphs.

Before describing installation procedures, some machine function characteristics that must always be taken into consideration when setting the working area.

When the lawn mower intercepts the perimeter cable signal or collides with the fence, it stops and moves immediately backwards changing direction.

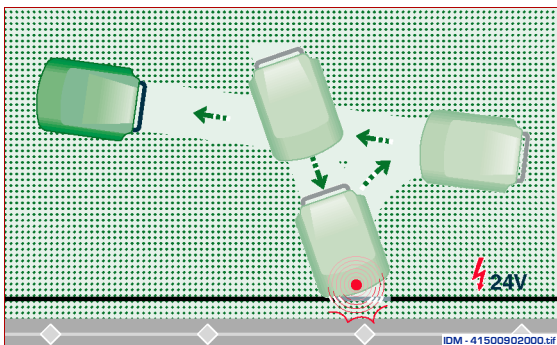

GB

If the garden path is level with the lawn and free of obstacles, it is not necessary to delimit it.

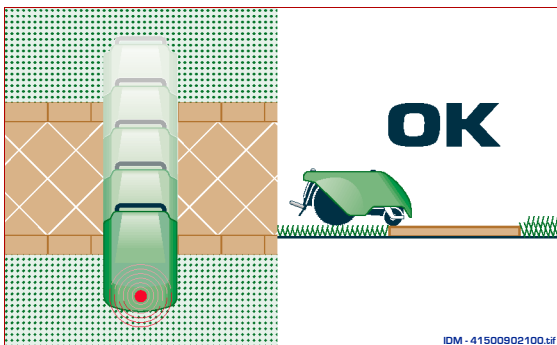

If the crossing lane forms a step it must be bordered.

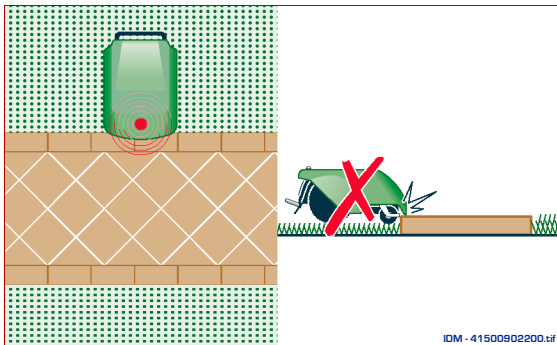

Do not delimit trees, fences or other objects that can tolerate the impact with the frame.

If obstacles that can support the body's collision are surrounded by flower beds or roots that can obstruct the lawn mower function or damage it, they must be bordered.

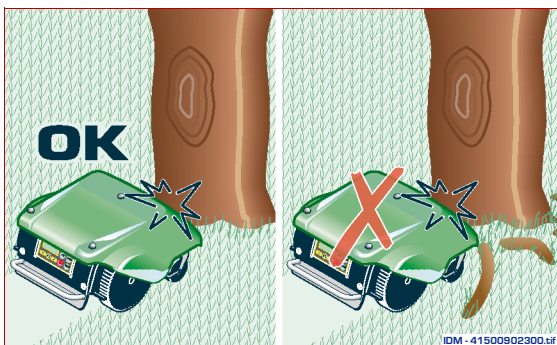

C141500900_fm

Working area with perimeter cable

Before installing the cable, decide the best location for the recharging base and the transformer [see p. 16].

The cable can be placed at ground level or underground. The signal quality and intensity could be compromised if cables are underground, as a matter of fact, with the cable at ground level the lawn mower detects the signal at a distance of 650÷750 cm., while with a cable 40 cm. underground this distance is reduced to 450 cm. For further information contact your dealer.

Start placing the cable from the point established for the recharging base and continue along the perimeter of the area following the ground irregularity. To allow the lawn mower to correctly enter the recharging base, the input end of the cable must be straight and perpendicular

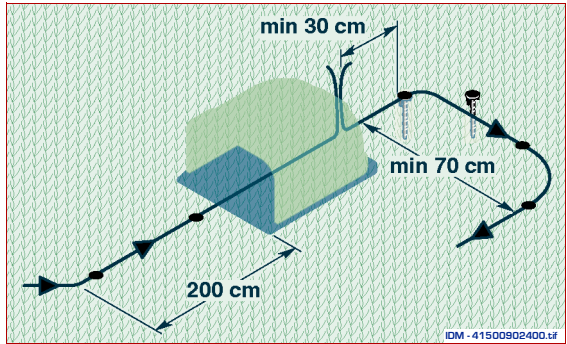

for at least 2 meters, and the output end of the cable must end at least 30 cm. away from the recharging base.

i Important

If the cable is placed at ground level, it must not be exceedingly taut and it must be secured with the proper nails supplied.

The illustration provides a typical installation example.

i Important

Respect the rotation direction around flower beds (counter clockwise).

Settings for a rapid return to the recharging base [see p. 15]

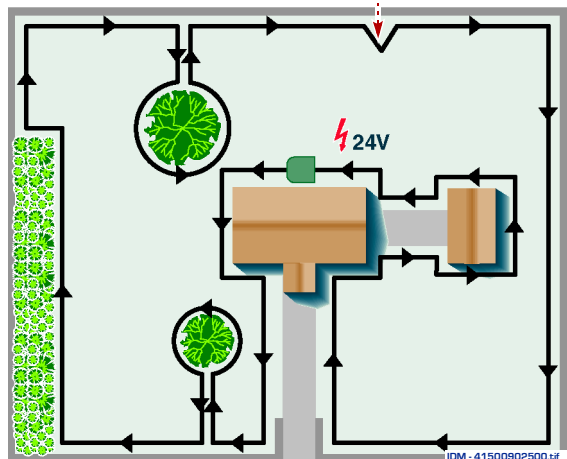

Example: separate working area installation

It is at times advisable to divide the working area into separate areas, as in the following cases:

- when lawns are not connected;

- when one area is considerably larger than the other and the two areas are connected by a passage that is too narrow.

In these cases, the recharging base must be positioned in the larger area, connecting the perimeter cable to the secondary area with a passage, bearing in mind that the distance between the two cables must not be below 70 cm. It will be like a "separate working area"; to mow the secondary area, the lawn mower must be programmed accordingly (see "Managing secondary areas").

GB

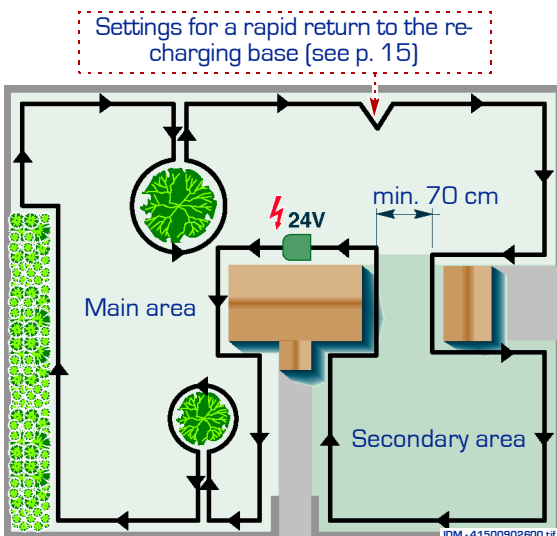

Example: closed separate working area installation

In case of closed working areas separated by a fence or other obstacles that block the lawn mower passage, both areas can be connected as shown in the figure. To mow the secondary area, the lawn mower must be manually transferred (see instructions on p. 22).

Note: if the main area cannot be connected with the closed secondary area, an additional recharging base can be bought for the secondary area.

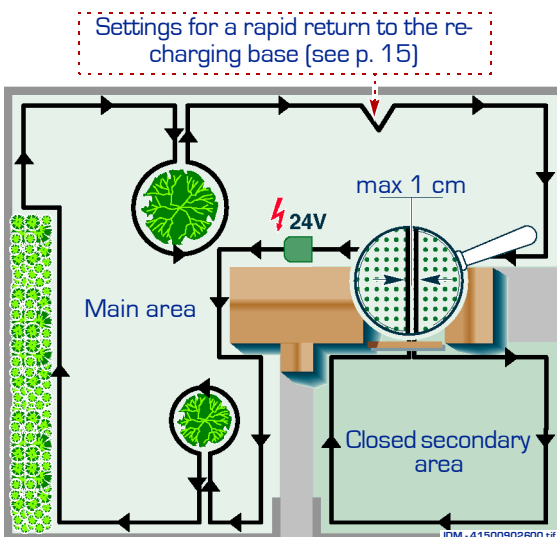

According to certain conditions (ex.: border walls, hedges, etc.), the perimeter cable must be installed at an adequate distance; illustrations show the installation distances of some typical conditions.

If the cable is placed near hedges, plant growth should be considered beyond the indicated 30 cm., or else provide periodical pruning.

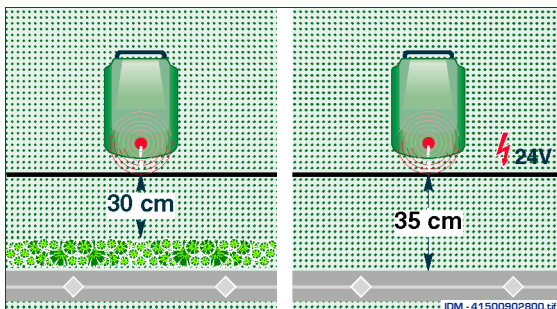

If mowing is required up to the limits of the area - with paving limits level with the lawn - position the perimeter cable at a distance of 5 cm.

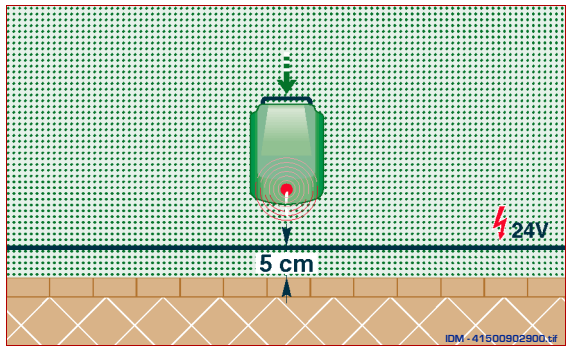

Example of flower bed limits: reduce the distance between the cables to a minimum.

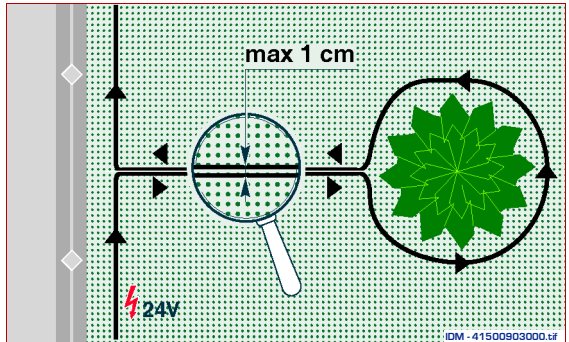

Minimum passage area: 2 m.

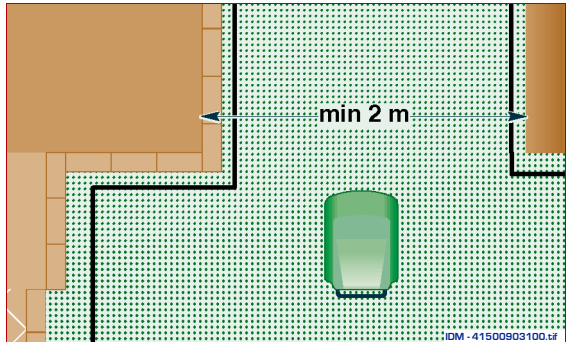

If public areas are at the lawn level (e.g. roads, water bodies, etc.), it is advisable to increase the border distance to 40 cm., or to border areas with a barrier at least 15 cm high (e.g. fence, wall) to prevent the lawn mower from going beyond the perimeter cable.

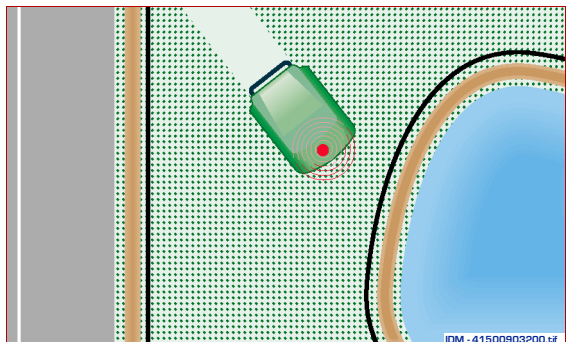

To avoid interference to the cable signal, keep it away from metallic objects (metallic drains or normal drains with electrical connections inside). Use specific clamps to add junctions, if necessary.



Important

Do not use insulating tape.

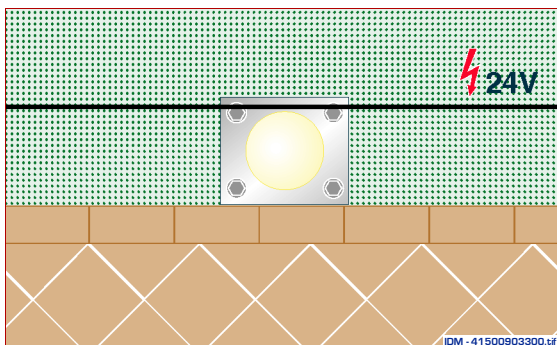

GB

Work area without perimeter cable and automatic return

If the area is bordered by a wall or a fence at least 10 cm. high, the lawn mower can work without a perimeter cable.

Decide the best position for the recharging base and the transformer (see p. 16).

The cable can be placed at ground level or underground. The signal quality and intensity could be compromised laying cables underground, as a matter of fact, with the cable at ground level the lawn mower detects the signal at a distance of 650÷750 cm., while with a cable 40 cm. underground this distance is reduced to 450 cm.

For further information contact your dealer.

Install the cable respecting distances indicated in the figure.

To allow the lawn mower to correctly enter the recharging base, the input end of the cable must be in straight and perpendicular.

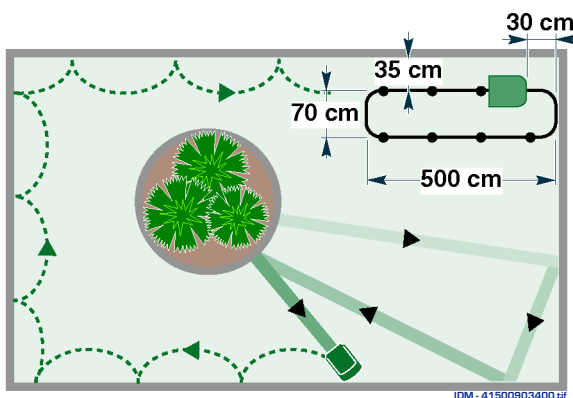

--- Return for recharge
 — Work



Important

If the cable is placed at ground level, it must not be exceedingly taut and it must be secured with the proper nails supplied.

To mow the area, program the lawn mower selecting "no perimeter" from the menu (see p. 26).

C141500900_fm

Work area without perimeter cable and manual return

If the area is bordered by a wall or a fence at least 10 cm. high, the lawn mower can work without a perimeter cable.

To mow the area, program the lawn mower selecting "no perimeter" from the menu (see p. 26) and press the start button; once the working time is over the lawn mower stops without searching the recharging base.

To recharge batteries, manually move the lawn mower to the main area.

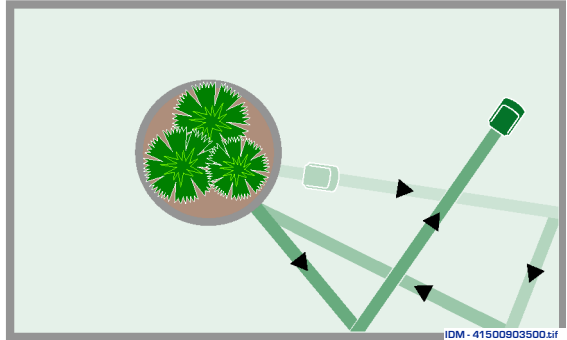

GB

Setting the rapid return to the recharging base

Some settings can be done along the perimeter cable that allow the lawn mower to change directions reducing the distance covered and the time to return to the charging base.

To do so, an equilateral triangle of 35 cm. should be formed with the perimeter cable. The illustration shows some useful indications to determine the right location of the setting for the rapid return to the charging base.

Note: when the lawn mower follows the perimeter to reach a secondary area it does not consider the settings for a rapid return.

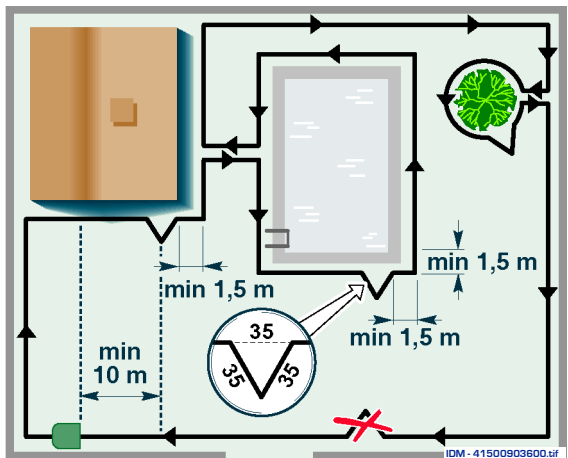

Important

If the setting for a rapid return is incorrectly placed, the lawn mower may not be able to return to the recharging base.

C14500900.fm

Installation of transformer and recharging base

The transformer must be protected from weather conditions, possibly by an adequately insulating cover (e.g. IP67), it must be kept away from children and connected to the electric power line. In-

stallation must be carried out correctly and according to current legislation. To connect the transformer to the power supply line, a standard electric plug is needed.



Danger - Attention

The transformer connection to the recharging base must be performed with the power supply disconnected.



Important

The distance between the transformer and the garage or perimeter cable should not be less than 3 meters and the cables should never be entangled.

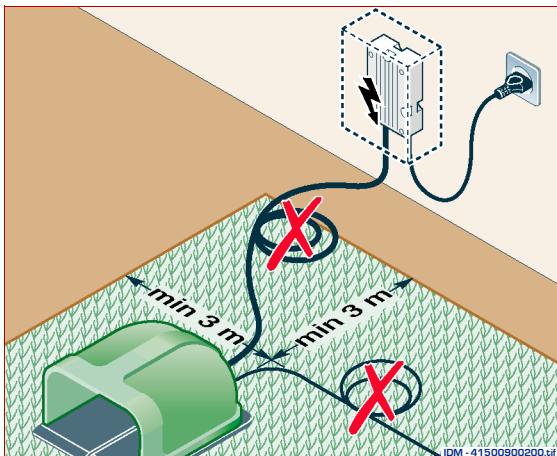

The best position for the recharging base is at the limit of the working area, on a flat, stable surface, with good drainage to avoid flooding.

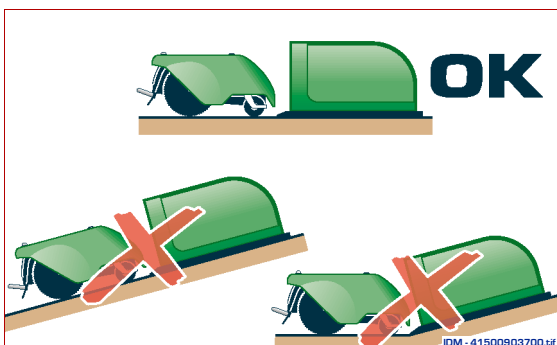

Perimeter cable - recharging base connection

- 1-Remove recharging base protection
- 2-Place recharging base in the pre-established area.

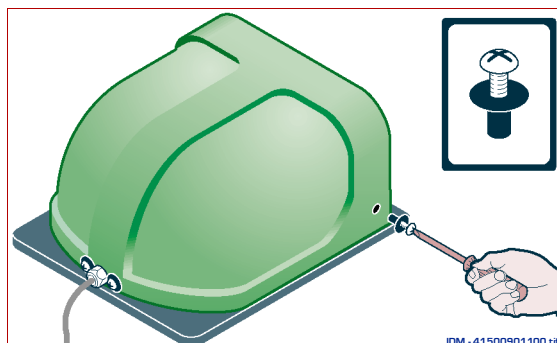



Danger - Attention

Remove the power cord to perform connections.

3-Insert cable as indicated.

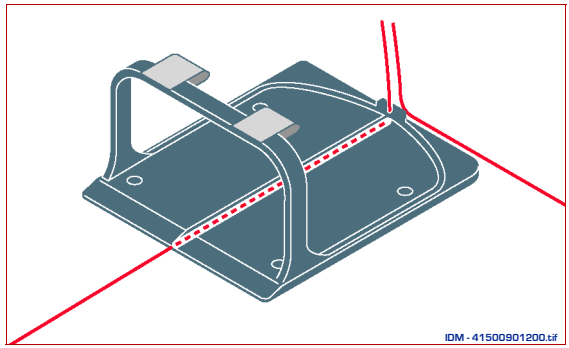

IDM - 41500901200.tif

4-Connect the two ends of the wire to the clamps of the base (see illustration).

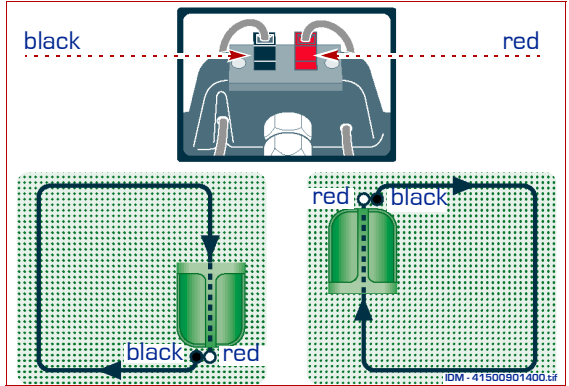

GB

5-Fasten the recharging base to the surface with nails (A); if necessary, use expansion dowels (B).

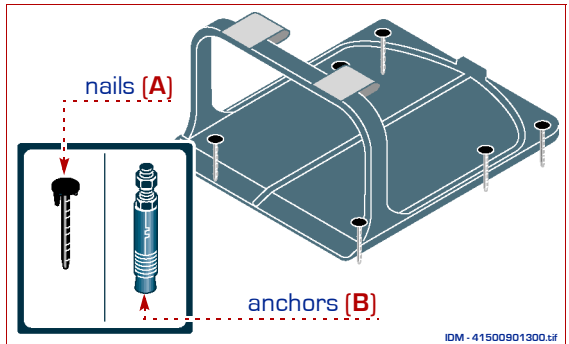

IDM - 41500901300.tif

6-Fasten the protection cover with the screws.

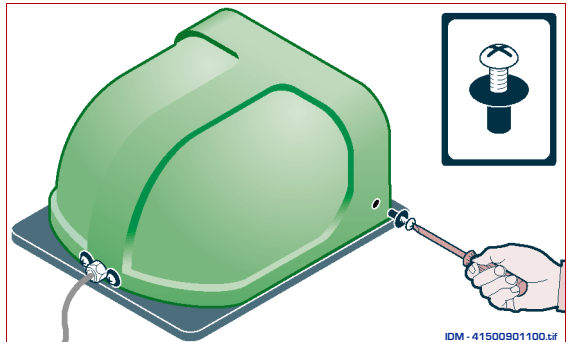

IDM - 41500901100.tif

C141500900.fm

7-Connect the base to the transformer by plugging in the connectors.

8-Insert the power supply cable plug (C) in the wall socket.

Now the lawn mower is ready to be programmed at desired times and modes.

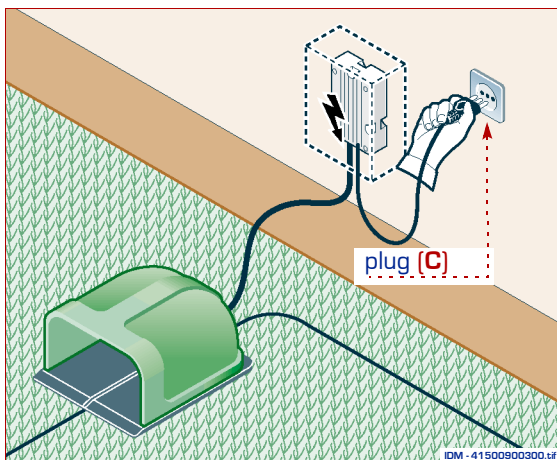

GB

OPERATING INSTRUCTIONS

DESCRIPTION OF KEYBOARD CONTROLS

Key [+]: when working, press to restart the previously stopped blade. When programming press to increase the items indicated by the menu.

Display: shows all functions.

ON: press to turn on the lawn mower.

PAUSE: press to stop the lawn mower, the display is in "stand-by"; it is now possible to program the lawn mower. When pressed again, the lawn mower resumes working. If the key is pressed during battery recharging, the lawn mower does not resume working until the key is pressed again and 'Pause' disappears from the display.

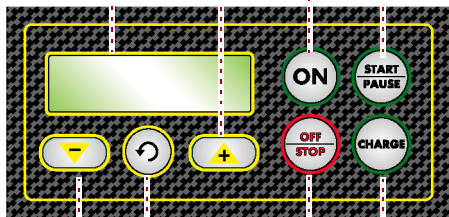

Key [-]: when working, press to stop the blade. When programming press to decrease items indicated by the menu.

ENTER: when working, press to start the spiral function. When programming press to confirm and save the selection performed.

CHARGE: press to bring the lawn mower back to the base and recharge the battery in advance. If the key is pressed while the lawn mower is recharging, recharging is interrupted and the lawn mower resumes working.

OFF/STOP: press to stop the lawn mower; the display turns off.

C1415100900_fm

IDM - 41500300400.it

STARTING

Before starting the lawn mower control that the garden is free of obstacles that could damage functional units (stones, toys, etc.).

- 1-Regulate the cutting height (pag. 20).
- 2-Make sure the cutting disc is installed correctly (p. 28).
- 3-Regulate the lawn mower balance (p. 20).
- 4-Place the lawn mower within the perimeter.
- 5-Press **ON** to turn it on.
- 6-Enter the saved password (only if it's not 0000) and press **ENTER**.

To set the antitheft password see programming procedures (p. 26).

STOP

To stop the lawn mower press the **PAUSE** key, then the **STOP** key.

! Danger - Attention
It is possible to stop the lawn mower by lifting it and a sensor halts all functions. However, this procedure should be avoided.

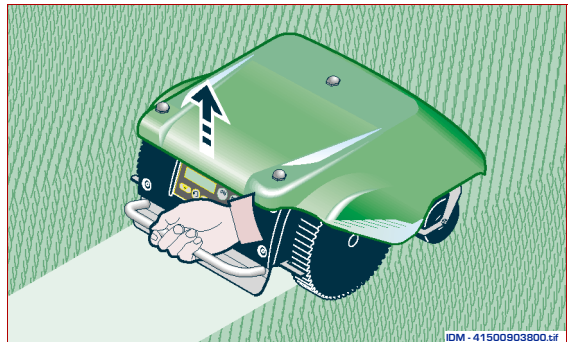

EMERGENCY STOP

To stop the lawn mower in the event of emergency press **STOP**.

Display description

While the lawn mower works, the display shows the following data:

- Sx**) left wheel motor speed;
- La**) blade motor speed;
- Dx**) right wheel motor speed;

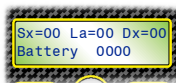

i Important

The first start of the lawn mower must be done on the recharging base and it must be recharged (pressing the **PAUSE** key) for at least 12 hours; this allows batteries to be perfectly charged and efficient, ready for use.

- 7-Press **PAUSE** to start the automatic working cycle.

i Important

If batteries are sufficiently charged, the lawn mower starts the working cycle, if they need to be recharged the lawn mower is positioned in "recharging".

An blinking light placed on the front of lawn mower automatically turns on during night work to point out its working position.

GB

Working phase commands

During the working phase the following functions can be performed by the lawn mower using the indicated buttons:

- press **PAUSE** to stop the lawn mower, press it again to restart it;
- press **CHARGE** to send the lawn mower to the recharging base to recharge batteries.

When the lawn mower is recharging press the same button to make it leave the recharging base and restart working.

- Press the **Key [-]** to stop the blade;
- press the **Key [+]** to start the blade;
- press **ENTER** to start the "spiral" working program.

CUTTING HEIGHT - SETTING

Cutting height can vary from 2 to 7 cm, according to the desired height of the grass.

! Danger - Attention
Before performing this setting turn the mower off by pressing OFF/STOP.

1-Remove the cutting blade.

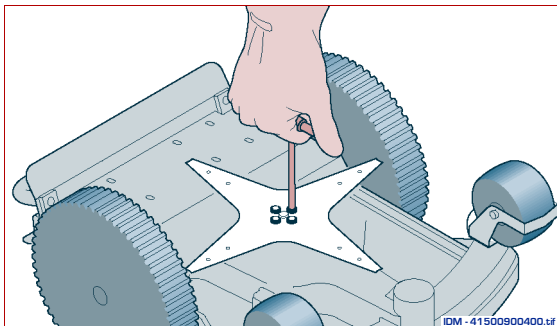

2-Unscrew the locking screw.

3-Manually lift or lower the cutting unit until desired height is reached, as indicated on the graduated plate.

4-When adjustment is concluded tighten fastening screws and reassemble the blade.

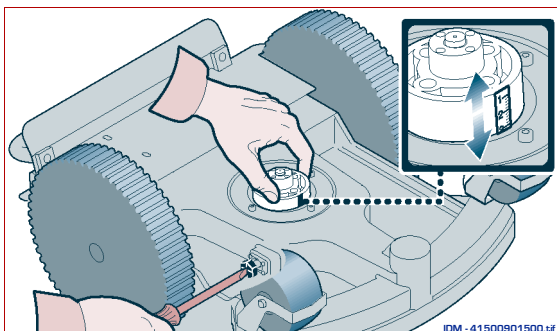

LAWN MOWER BALANCING- ADJUSTMENT

The lawn mower is supplied with balance adjusted for flat grounds. In case of sloped grounds, the lawn mower balance can be modified by moving both batteries forwards or backwards.

1-Unscrew both nuts (A) and remove the top hood.

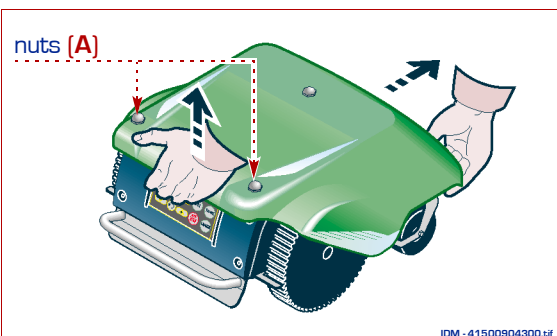

2- Unscrew the four fastening screws and remove the battery guards (B).

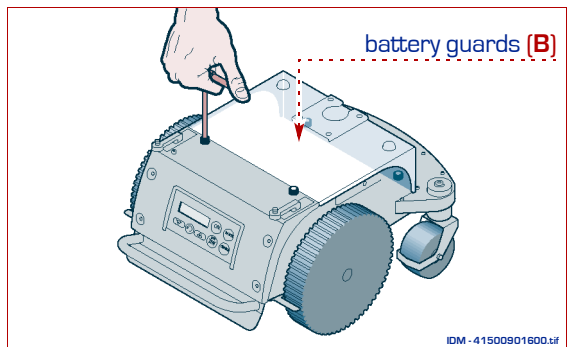

3- Unscrew the battery base fastening nut (C) and place the pin in one of the four available pin holes (D).

4- Perform the same adjustment on the other battery.

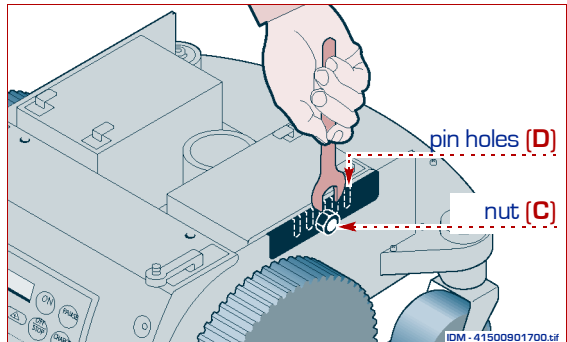

GB

RAIN SENSOR ADJUSTMENT

1- Rotate the cam pin to adjust the distance (X) between one and the other.

i Important

Machine sensitivity increases when the distance between the pins decreases. It is advisable not to keep the pins too close together.

2- Press the **ON** key.

3- Access programming and turn on the rain control (see page 26).

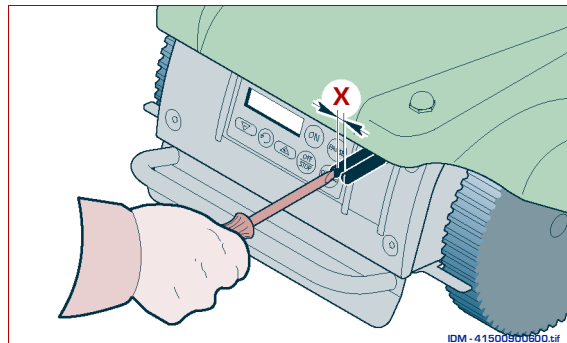

GENERAL SUGGESTIONS

- The first time the lawn mower is used, grass height must not be over 10 cm.
- If grass is too high, run the mower lowering the blade by 1 cm at a time every 1÷2 days, until the desired height is reached.
- With the correct programming, the lawn will be perfect at all times.

- It is advisable to program the mower so as not to make it work more than necessary, bearing in mind the seasonal variation in grass growth, so as not to expose it to unnecessary wear and reduced battery working life.
- Make sure that the lawn to mow is free of projecting objects (e.g. small rocks, tree roots) that could damage the blades of the cutting disc.

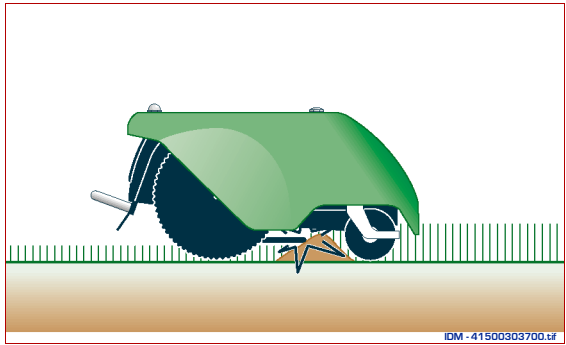

IDM - 41500303700.tif

GB

Work in separate closed areas

- 1-Retrieve the lawn mower robot from the recharging base making sure the yellow light on the transformer is permanently on (batteries in maintenance).
- 2-Press **OFF** and put the robot in the area without perimeter cable or recharging base.
- 3-Press **ON** with password if any, and **ENTER**, afterwards press **PAUSE, [-] Key** and **[+] Key**, the message "external" will be shown on the display for some seconds, and the lawn mower will start working.
- 4-When batteries charge is finished, the lawn mower will travel along the perimeter noticing the absence of the recharging base and it will turn off

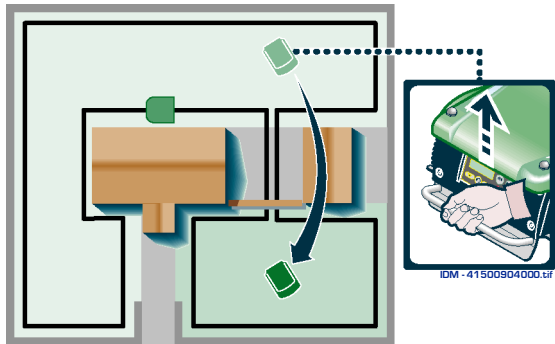

IDM - 41500904000.tif

automatically (once it's turned off and on this function will no longer be set).

- 5-Bring the mower near the recharging base; press **CHARGE** to bring the lawn mower back to the base and recharge the battery in advance.

Work in areas without perimeter cable or recharging base

- 1-Retrieve the lawn mower robot from the recharging base making sure the yellow light on the transformer is permanently on (batteries in maintenance).
- 2-Press **OFF** and put the robot in the area to be mowed.

- 3-Access the menu and select **NO** at the perimeter item (p. 26).
- 4-Press **ENTER**, exit the programming function pressing **PAUSE** and the lawn mower will start the automatic working cycle, continuing until the working time has expired.

Work in small areas without perimeter cable and with the presence of an operator

- 1-Retrieve the lawn mower robot from the recharging base making sure the yellow light on the transformer is permanently on (batteries in maintenance).
- 2-Press **OFF** and put the robot in the area to be mowed.

C:\14500900.fm

3-Access the menu and select NO at the perimeter item (p. 26).

4-Press **ENTER** and the lawn mower will start the working cycle.



Danger - Attention

This operation must be performed under operator control who must create an obstacle every time the lawn mower should change direction. Do not use feet to create an obstacle.

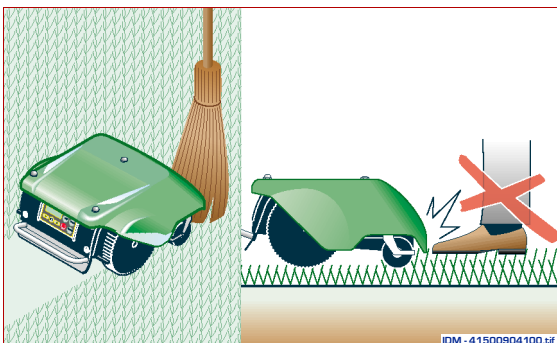

GB

PROGRAMMING PROCEDURES

Lawn mower use can be easily personalized following the procedures shown below.

The **CASCADE** menu allows language selection, date and time setting, lawn mower work programming and secondary area management.

The menu consists of the following options:

- SET LANGUAGE (p. 24)
- SET DATE AND TIME (p. 24)
- SET WORKING SCHEDULE (p. 24)
This setting allows working hours to be set during the day and working days during the week.
- SET SECONDARY AREAS (p. 25)
This option allows automatic mowing management of one or two secondary areas in the garden.
- SET PERIMETER (p. 26)
This option allows to set the machine functioning by perimeter cable or by collision.

- SET PASSWORD (p. 26)
This option allows a personalized password to be defined, that, in case of theft, will prevent the lawn mower from being used.
- SET RAIN SENSORS (p. 26)
To access the menu press the keys sequentially.

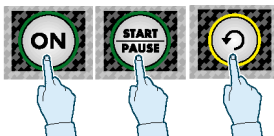

After entering the desired value, press **ENTER** and press **PAUSE**.



Important

If **STOP** is pressed instead of **PAUSE**, all values set will be cancelled.

Set Language

The display shows:



- 1-Press **(+) Key** and **(-) Key** to scroll available languages.
- 2-Press **ENTER** to confirm modified values.

Set Date and Time

- 1-Press **ENTER**.

The display shows:



- 2-Press **ENTER** to place the cursor on day, month, year.
- 3-Press **(+) Key** and **(-) Key** to modify numerical values.
- 4-Press **ENTER** to confirm modified values.
- 5-Press **ENTER**.

The display shows:

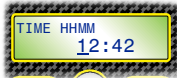

- 6-Press **ENTER** to place the cursor on **HOUR** and **MINUTES**.
- 7-Press **(+) Key** and **(-) Key** to modify numerical values.
- 8-Press **ENTER** to confirm modified values.

Set working schedule

- 1-Press **ENTER**

The display shows:



2-Program every single day of the week entering the number **1** (to turn it on) or **0** (to keep it stand by).

3-Press **ENTER** to move the cursor to values to be modified.

4-Press **(+) Key** and **(-) Key** to modify numerical values.

5-Press **ENTER** to confirm modified values.

6-Press **ENTER**.

The display shows:

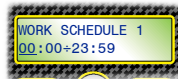

7-Program the working schedule for the first part of the day.

[Example from 07.00 to 09.00 a.m.].

8-Press **ENTER** to move the cursor to values to be modified.

9-Press **(+) Key** and **(-) Key** to modify numerical values.

10-Press **ENTER** to confirm modified values.

11-Press **ENTER**.

The display shows:

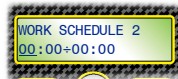

12-Program the working schedule for the second part of the day. [Example from 7.00 to 10.00 p.m.].

13-Press **ENTER** to move the cursor to values to be modified.

14-Press **(+) Key** and **(-) Key** to modify numerical values.

15-Press **ENTER** to confirm modified values.

Secondary settings

To perform this function, the time needed for the lawn mower to reach the secondary area following the perimeter cable must be programmed.

Follow indications below to calculate the time:

- 1-Place the lawn mower out of the recharging base directed towards the output cable.
- 2-Press **ON** and **CHARGE**.
- 3-Record the time the lawn mower needs to reach the middle of the secondary area.

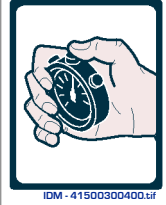
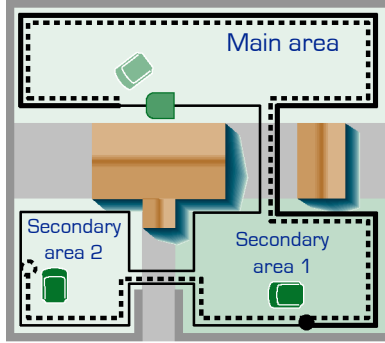

i Important

If there is a setting for the rapid return on the way to the secondary area, the lawn mower must be manually directed to the perimeter cable when it exits.

- 4-Press **ENTER**.

The display shows:



- 5-Press **(+) Key** and **(-) Key** to enter the number of working cycles to be performed in the main area, after which the lawn mower will start mowing the first secondary area. If there is no secondary area enter "zero" [0].

- 6-Press **(+) Key** and **(-) Key** to modify numerical values.

- 7-Press **ENTER** to save the number of cycles.

- 8-Press **ENTER**.

The display shows:



- 9-Press **(+) Key** and **(-) Key** to enter the time (in minutes) needed by the lawn mower to reach the first secondary area. If there is no secondary area enter "zero" [0].

- 10-Press **ENTER** to save the time.

- 11-Press **ENTER**.

The display shows:



- 12-Press **(+) Key** and **(-) Key** to enter the number of working cycles to be performed in the main area, after which the lawn mower will start mowing the second secondary area. If there is no second secondary area enter "zero" [0].

- 13-Press **ENTER** to save the number of cycles.

- 14-Press **ENTER**.

The display shows:



- 15-Press **(+) Key** and **(-) Key** to enter the time (in minutes) needed by the lawn mower to reach the second secondary area.

If there is no secondary area enter "zero" [0].

- 16-Press **ENTER** to save the time.

Set Perimeter

1-Press **ENTER**.

The display shows:



2-Program the type of perimeter installed in the area to be mowed.

Select YES if perimeter cable has been installed.

Select NO if perimeter cable has not been installed.

Select ×2 if there are signal problems (perimeter cable mounted).

Select ×4 if the problem is not resolved with option ×2.

Select ×6 if the problem is not resolved with option ×4.

i Important

When the mower is turned on it automatically sets in Perimeter Yes mode. Options NO, ×2, ×4, ×6 are deactivated when the mower is turned off. Use them with extreme caution only in the event there are no pools or slanted areas.

3-Press **(+) Key** and **(-) Key** to modify.

4-Press **ENTER** to save the program.

Set Password

1-Press **ENTER**.

The display shows:



The lawn mower can be protected by a password made of four digits that the user may personalize following the instructions below.

The password set by default is 0000; it's advisable to enter four numbers that can be easily remembered (ex: birth date)

2-Press **(+) Key** and **(-) Key** to enter YES

3-Press **ENTER** to save the program.

The display shows:



4-Enter the old password selecting every single digit with **ENTER** and modifying values with **(+) Key** and **(-) Key**.

5-Press **ENTER** to save the program.

6-Press **ENTER**.

The display shows:



7-Enter the new password using **ENTER (+) Key** and **(-) Key**.

8-Press **ENTER** to save the program.

The display shows:



9-Enter new password again.

10-Press **ENTER** to permanently save.

Set Rain Sensors (for the DELUXE model only)

1-Press **ENTER**.

The display shows:



2-Press **(+) Key** and **(-) Key** to set the rain sensor

Select YES to activate the rain control

Select NO to ignore the rain control

REMOTE CONTROL USE

i Important

The remote control works with infrared rays. Keep it directed towards the receiver no further than 6 m away.

- A) RIGHT ARROW:** hold down to move the machine to the right.
- B) LEFT ARROW:** hold down to move the machine to the left.
- C) PAUSE/START:** press to turn the machine on or, if already on, to pause.
- D) FUNCTIONS KEY:** hold down this key to perform the following operations:

1-Make the machine leave the recharging base and start the work cycle, provided that it has been programmed.

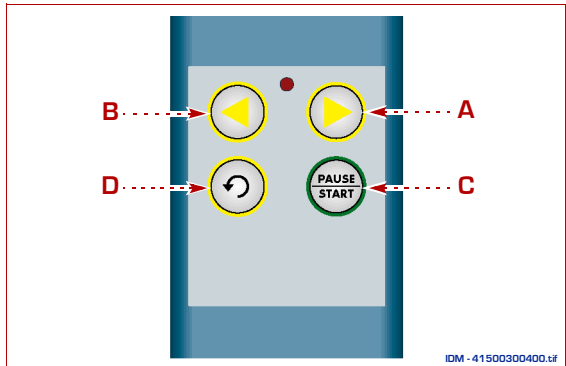

2-Make the machine perform spiral movement (only if on and moving).

3-Send the machine to recharge (only if on and in pause).

4-Move the machine away from the perimeter cable, if it follows the cable and does not function correctly.

MAINTENANCE INFORMATION

All maintenance works and replacing of components must be performed by persons with the necessary experience and technical skills.

⚠ Danger - Attention

Unplug the mower.

Use protective gloves when operating on the cutting disc.

CLEANING AND MAINTENANCE OF THE MOWER

To clean the frame use a sponge soaked in a solution of water and detergent. Do not use water under pressure to avoid damaging the electrical parts. Do not use solvents or gasoline to avoid damaging the painted surfaces. Weekly remove grass residue from un-

der the body (if grass is wet, perform this operation more frequently).

Periodically make sure moving parts (blade, front and rear wheels) are not obstructed or slowed by dirt or other. Suitably intervene if necessary.

RECHARGING BASE CLEANING

Periodically control that the recharging base is free of any object (leaves, ani-

mals, etc.), that may impede the lawn mower entrance.

CHECKING THE CUTTING DISC

Check cutting blades weekly.
Use a brush to eliminate possible incrustations from the blades.

If necessary, reverse, sharpen or replace the disc.

CLAMPS AND CONTACT PLATES

Check weekly the contact clamps (A) of the mower and the plates (B) on the base, clean them with a dry cloth. If black signs are evident on the clamps - indicating bad electrical contact - verify the position of the clamps on the plates, when recharging of the mower.

If corrosion signs are evident on the clamps or on the plates, clean them using fine abrasive paper.

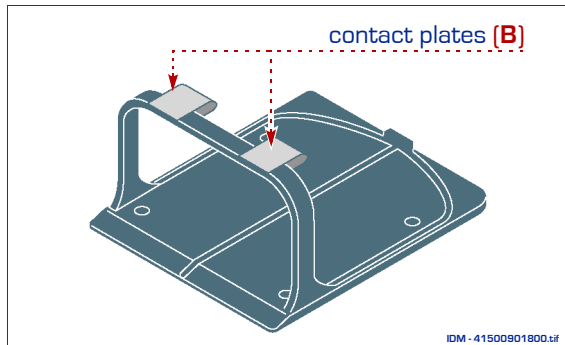
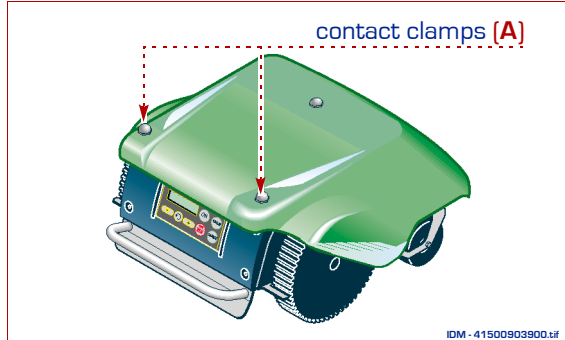

CUTTING DISC - REPLACEMENT

- 1-Turn off the lawn mower.
- 2-Overturn the lawn mower on a surface that doesn't damage the protection.
- 3-Remove grass residues from the disc screw.
- 4-Unscrew disc fastening screws.

⚠ Danger - Attention
Mount the cutting disc with the tabs facing the body.

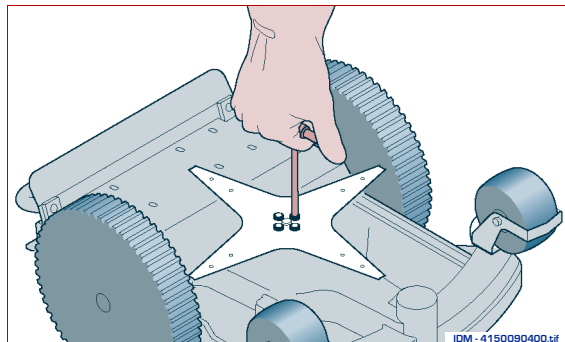

C141500900.fm

5-Turn the disc to use the second cutting side of the blade, or sharpen it, or replace it with a new one.

6-Tighten the disc fastening screws.

REPLACING THE BATTERIES

Battery range depends on the number of working hours the mower performs.

Generally, the battery working range is between 600 and 1000 cycles.

1-Remove the cutting disc.



Danger - Attention

This operation should always be performed, since when new batteries are mounted the blade could start working for some seconds creating hazardous situations.

2-Unscrew both nuts (A) and remove the hood (B).

3-Unscrew the four fastening screws and remove the battery guard (C).

4-Take the batteries (D) out disconnecting the clamps (E) and replace them.



Important

Reconnect the clamps according to the polarity of the new batteries; a wrong connection may damage the electronic parts of the mower.

Used batteries must be given to an authorized collection centre.

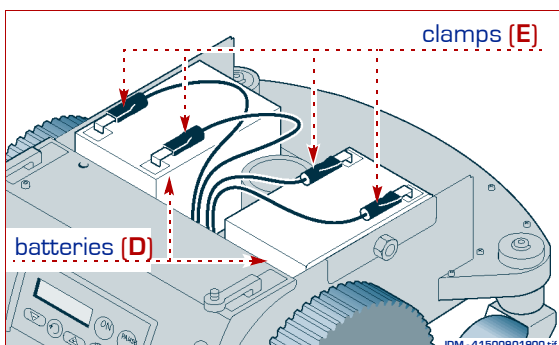
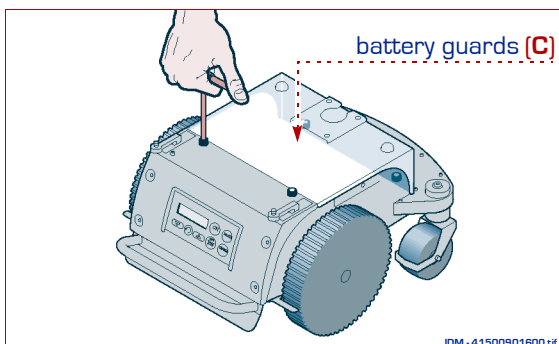
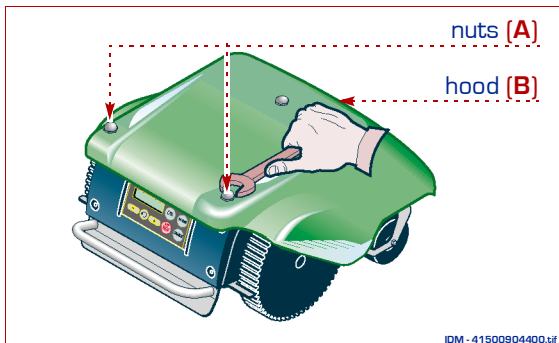

LAWN MOWER STORAGE

If the mower is not used for a long period of time, it is advisable to keep it in a safe, dry place.

Before storage, recharge the mower for at least 12 hours:

- 1-carefully clean the lawn mower;
- 2-place the lawn mower in the recharging base;
- 3-the display shows "recharging" and the battery tension value;
- 4-press **PAUSE**;

5-when recharge is done (at least 12 hours) turn the lawn mower off and place it in a dry place at an environmental temperature of 10÷30°C;

6-control batteries charge status once a month, and recharge them if necessary. Or use the suitable recharge kit for winter garaging. Contact your dealer.

The transformer must be unplugged from the power supply.

RESUMPTION FOR WORK AFTER STORAGE

Plug the recharging base to the power supply and make sure the plates are clean;

- 1-bring the mower near the recharging base;
- 2-press the **ON** key and then the **CHARGE** key.

The mower searches for the perimeter cable and follows it to the base where it will recharge.

If the batteries need recharging, the mower positions shows 'recharging'; if the batteries are sufficiently charged the mower starts the work cycle as programmed.

Important

If batteries are under the protection voltage; it is necessary to use a car battery charger to recharge them (12V/3 Ampere max).

BATTERY RECHARGING WITH WINTER RECHARGING KIT

- 1-First connect wire connector (A) and then wire connector (B).
- 2-Press the **ON** key and wait until the display shows:



Danger - Attention

This operation must be performed placing the machine more than 10 meters away from the perimeter. If, after pressing the **ON** key, the machine starts to move or the display shows **OUT OF PERIMETER**, turn the machine off and

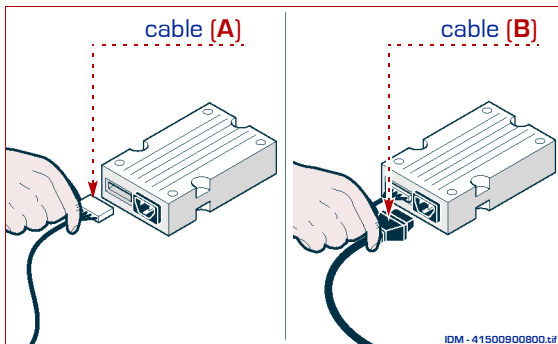

move it further away from the perimeter and turn it on again.

3-Connect the black connector **(C)** with negative polarity **(-)** and the red connector **(D)** with positive polarity **(+)** to the corresponding knobs.

Note: If the operation is not performed within 30 seconds from the operations described in point 2, the machine automatically turns off. Restart from point 2 and repeat the procedure.

4-The writing on the display:



Ensures correct connector connections. The yellow power led must blink or stay on.

i Important

Periodically check the machine during recharging. If the power supply is interrupted for a long period of time, the machine automatically turns off and the ON key must be pressed again.

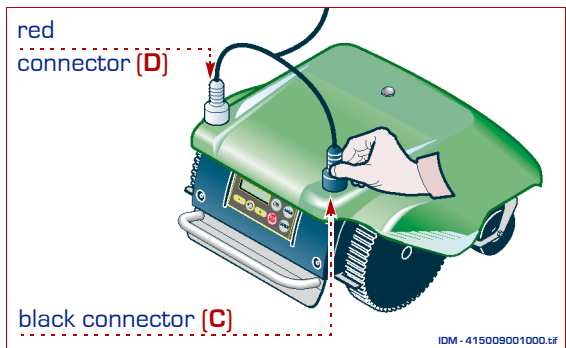

5-To disconnect the machine from the winter recharge, press **OFF** and disconnect connectors **(C)** and **(D)**.

GB

TROUBLE SHOOTING

PROBLEMS, CAUSES, SOLUTIONS

The following is a list of problems that may occur during standard use of the mower.

If the solutions described do not solve the problem, contact the Service Centre.

PROBLEM	CAUSE	REMEDY
The display shows "NO Signal"	Incorrect connection of the perimeter cable to the base.	Verify the connection of the perimeter cable or the plug connection to the base, Control that the transformer green light blinks, if it doesn't there is an interruption in the perimeter cable. Verify the integrity of the perimeter cable.
	Interruption of perimeter cable.	
The lawn mower leaves the working area	Excessive ground slope.	Verify the ground slope and if necessary border the area.
	Perimeter cable incorrectly placed.	Verify the cable placing.
	Interference caused by metallic objects.	Correctly place the perimeter cable.

C1415 00900.fm

PROBLEM	CAUSE	REMEDY
The lawn mower doesn't correctly return to the recharging base.	The transformer cable has been placed incorrectly or the perimeter cable passes near the base.	Stretch the transformer cable or move the perimeter cable away from the recharging base.
The lawn mower behaves abnormally around the flower beds.	The perimeter cable has been incorrectly placed.	Invert the rotating direction around the flower bed. Counter clockwise
GB Working area not completely mowed	Insufficient working hours.	Extend the working hours.
	Working area too wide.	Limit working area or extend working hours.
	Obstructed cutting disc.	Control that the cutting disk rotates freely.
	Worn cutting blades.	Replace cutting disk.
The mower does not work enough with respect to the set time.	Clocks incorrectly set.	Set the lawn mower clock correctly.
	Working schedule set incorrectly.	Set working schedule correctly.
The lawn mower works less that the time set	Batteries are worn or not correctly recharged.	Replace batteries (write the number of cycles and total working hours in the manual). Recharge batteries for at least 12 hours leaving the machine set to PAUSE on the recharging base
Secondary area not completely mowed	Incorrect programming.	Correctly program secondary area..
The machine doesn't perform the rapid return or doesn't reach the recharging base	Rapid return incorrectly set.	Control the exact settings for the rapid return.
The lawn mower doesn't reach secondary areas	Incorrect programming.	Control the number of cycles and the crossing time.
	Rapid return to recharging base.	Calculate time correctly keeping in mind the rapid return to recharging base (see p. 25).