

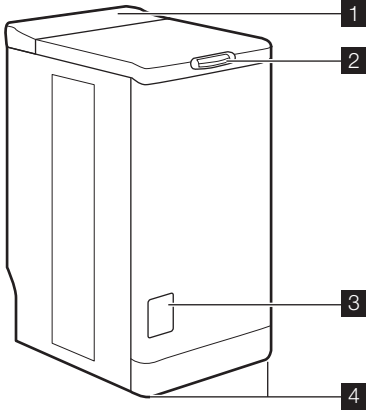

user manual

Washing Machine

EWT 105410 W



1. The control panel
2. Lid button
3. Filter access cover
4. Adjustable levelling feet

The control panel

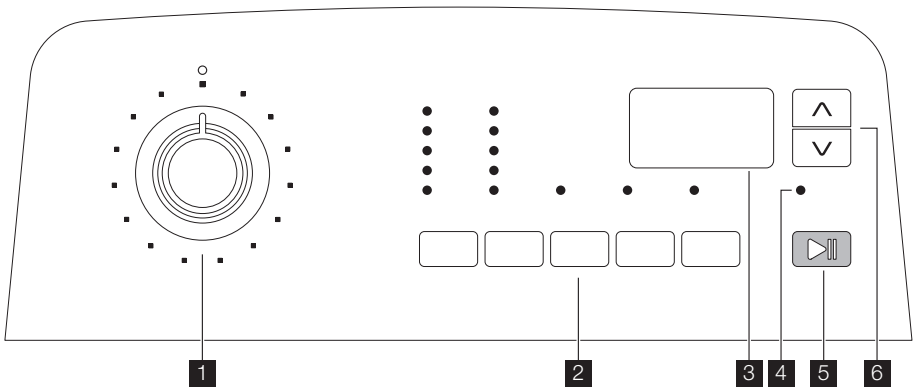

1. Programme selector
2. Pushbuttons and their functions
3. Display
4. "Add washing" light
5. "Start/Pause" pushbutton
6. "Time manager" pushbuttons

The symbols

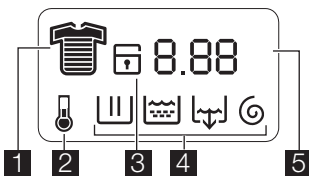

1. Time manager
2. Temperature
3. Child safety
4. Cycle running : Prewash/Wash, Rinse, Drain, Spin
5. Length of cycle or Timer delay count-down

Dispenser box

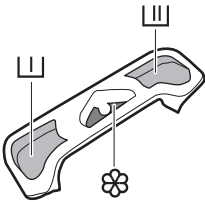

1 Prewash

2 Wash

⊗ Softener (do not fill above the MAX symbol **M**)

SAFETY INFORMATION

Please read these points carefully before installing and using your appliance. Keep this user manual with your appliance.

General safety

- Do not modify or attempt to modify this appliance. This would put yourself in danger.
- Ensure that all coins, safety pins, brooches, screws etc have been removed before starting a washing programme. If left in washing, they can seriously damage the appliance.
- Use the recommended quantity of detergent.
- Put small items together (socks, belts etc.) in a small linen bag or pillow case.
- Unplug and close inlet hose tap after using appliance.
- Always disconnect the power supply from the appliance before cleaning or maintenance.
- Do not machine wash clothes with ribbing, unfinished or torn material.

Installation

- Unpack or ask for the appliance to be unpacked immediately upon delivery. Check the outside of the appliance is not damaged in any way. Report all transit damage to your retailer.
- Remove all transit bolts and packaging before installing the appliance.
- Connection to the water supply must be carried out by a qualified plumber.
- If your domestic electrical circuit needs adapting to allow the appliance to be plugged in, use a qualified electrician.
- Ensure that, after installation, the power cable is not trapped under the appliance.

- If the appliance is installed on carpeted floor, ensure that the carpet does not obstruct any ventilation ducts located at the base of the appliance.
- The appliance must be equipped with an earthed power plug which conforms to regulations.
- Before connecting your appliance to the power supply, carefully read the instructions in the chapter entitled “Electrical connection”.
- Replacing the power cable should only be carried out by an authorised service engineer.
- The manufacturer cannot be held responsible for any damage resulting from incorrect installation.

Precautions to be taken against frost

If your appliance is exposed to temperatures below 0°C, the following precautions must be taken:

- Close the tap and disconnect the inlet hose.
- Place the end of this hose and the drain hose in a basin on the floor.
- Select the Drain programme let it run until the end of the cycle.
- Disconnect the appliance from the power supply by turning the programme selector to “Stop” **O**.
- Unplug the appliance.
- Replace the inlet hose and drain hose. This way, the water remaining in the hoses will be drained away, avoiding any ice formation which would damage your appliance.

Before turning your appliance on again, ensure that it is installed in an area where the temperature will not fall below freezing.

Use

- Your appliance is intended for normal domestic use. Do not use the appliance for commercial or industrial purposes or for any other purpose.
- Refer to the instructions on the label of each item before washing.
- Do not put items into the washing machine which have had stains removed with petrol, alcohol, trichlorethylen etc. If such stain removers have been used, wait until the product has evaporated before putting these items into the drum.



- Empty pockets and unfold items.
- This appliance is not intended for use by persons (including children) with reduced physical, sensory or mental capabilities, or lack of experience and knowledge, unless they have been given supervision or instruction concerning use of the appliance by a person responsible for their safety.
Children should be supervised to ensure that they do not play with the appliance.

PERSONALISATION

Child safety

This option provides two types of locking :

- if the option is activated after the cycle has started, no changes to the options or programme is possible.
The cycle runs and you must deactivate the option to run a new cycle.
- if the option is activated before the cycle has started, the appliance cannot be started.

To activate child safety, turn appliance on and press "Rinse plus"  and "Delay start"  simultaneously until the confirmation symbol  shows on in the display. The appliance memorises the selection of this option. To deactivate child safety, repeat the process.

HOW TO RUN A WASH CYCLE?

Using for the first time

-  • Ensure the electrical and water connections comply with the installation instructions.
- Remove the polystyrene insert and all other items inside the drum.

- Run an initial wash cycle at 90°C, without any washing but with detergent to clean the water tank.

DAILY USE

Loading washing

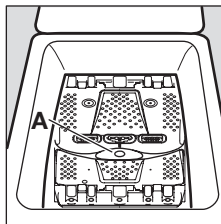

- Open the lid of the appliance.
- Open the drum by depressing the locking button A: The two shutters unlock automatically.
- Load the washing, close the drum and the lid of your washing machine.



 **Warning!** Before closing the lid of your appliance, ensure that the drum is properly closed :

- When the two shutters are closed,
- locking button A released.

Proportioning of detergents



Pour the amount of washing powder into the washing  and prewash  compartments if you have selected the "prewash" option. Pour fabric softener into the compartment  if necessary.

Selection of desired programme

Turn the programme selector to the required programme. The "Start/Pause" pushbutton flashes green.

If you turn the programme selector to another programme while a cycle is in progress, the appliance will ignore the new selected programme. “Err” flashes and the “Start/Pause” pushbutton flashes red for a few seconds.





Selecting the temperature

Press the “Temperature”  pushbutton repeatedly to increase or decrease the temperature (see “Programmes table”). The  symbol means a cold wash.

Selecting the spin speed

Press the “Spin”  pushbutton to change the spin speed.

The maximum spin speeds are :
for Cottons, Wool, Lingerie, Eco, Jeans : 1000 rpm, for Synthetics, Easy iron, Intensive sport : 900 rpm, for Delicates, Silk, Sport : 700 rpm.

At the end of the programme, if you have selected “Rinse hold”  or “Night cycle plus” , you then need to select a “Spin”  or “Drain”  programme to finish the cycle and empty the water.

Selecting options

You must select the different options after selecting the programme and before pressing the “Start/Pause” pushbutton (see “Programme table”). Press the desired button(s) ; the corresponding lights come on. If pressed again, the lights go out. If one of the options is not compatible with the selected programme, “Err” flashes on the display and the “Start/Pause” pushbutton flashes red.



“Prewash” option

The appliance runs a prewash at 30°C max.

“Rinse plus” option

The washing machine will add one or more rinses during the cycle. This option is recommended for people with sensitive skin and in soft water areas.

Temporary : Press the “Rinse plus”  pushbutton. The option is only active for the selected programme.

Permanent : Hold down the “Prewash”  and “Delay Start”  pushbuttons for a few



seconds. The option is permanently activated, even if the appliance is switched off. To deactivate it, repeat the process.

“Delay start”

This option allows you to delay the start of a wash programme by 30, 60, 90, 2 hours to 20 hours. The selected time appears on the display for a few seconds.

You can change or cancel the delayed start time at any time before you press the “Start/Pause” pushbutton, by pressing the “Delay start”  pushbutton again (0' indicates immediate start).







If you have already pressed the “Start/Pause” pushbutton and you want to change or cancel the delayed start, proceed as follows :

- To cancel the delayed start and start the cycle immediately, press “Start/Pause” and then “Delay start” . Press “Start/Pause” to start the cycle.
- To change the timer delay period, you must go through the “Stop”  position and reprogramme your cycle.

The lid will be locked during the delayed start time. If you need to open it, you must first pause the appliance by pressing the “Start/Pause” pushbutton. After closing the lid again, press the “Start/Pause” pushbutton.

Time Manager

The cycle can be made longer or shorter by using the “Time Manager”  pushbuttons. The level of soiling of the laundry is also indicated.

Soil level	Icon	Type of fabric
Intensive		For heavy soiled items
Normal		For normal soiled items
Daily		For daily soiled items
Light		For slightly soiled items
Quick ¹⁾		For very slightly soiled items
Super quick ¹⁾		For items used or worn for a short time
Refresh ¹⁾	 ²⁾	For refreshing items only

Soil level	Icon	Type of fabric
Super re-fresh ¹⁾	 2)	For refreshing a very few items only

1) To use on a half load.

2) The symbol flashes and disappears : this wash cycle is a refresh cycle only.

The availability of these different levels varies depending on the selected programme type.

Start of the programme

Press the “Start/Pause” pushbutton to start the cycle ; the corresponding light will come on green. It is normal for the programme selector to remain stationary during the cycle. The symbol for the current cycle and the remaining time appear on the display. If a delayed start has been selected, the countdown appears on the display.

Warming up

During the cycle, the  symbol comes on when the appliance is reaching the right temperature.

Interrupting a programme

Adding washing

When the “Add washing” light  is on, you can add washing by proceeding as follows. Press the “Start/Pause” pushbutton : the corresponding light will flash green while the appliance is paused. The lid can only be opened around 2 minutes after the washing

machine has come to a stop. Press the “Start/Pause” pushbutton again to continue the programme.

Modifying the programme in progress

Before making any changes to the current programme, you need to pause the washing machine by pressing the “Start/Pause” pushbutton. If the modification is not possible, “Err” flashes in the display and the “Start/Pause” pushbutton flashes red for a few seconds. If you still decide to change the programme, you must cancel the current programme (see below).

Cancelling the programme





If you want to cancel the programme, turn the programme selector to the “Stop” position .









End of the programme

The washing machine stops automatically ; the “Start/Pause” pushbutton goes out and “0” flashes on the display. The lid can only be opened around 2 minutes after the washing machine has come to a stop. Turn the programme selector to the “Stop”  position. Remove washing. Unplug and close water inlet tap.

Stand by : once the programme has finished after a few minutes the energy saving system will be enabled. The brightness of the display is reduced. By pressing any button the appliance will come out of the energy saving status.

PROGRAMMES TABLE

Programme / Type of washing	Load	Possible options
 Cottons (cold - 90°) : White or colour, e.g. normally soiled work clothes, bed linen, table linen, body linen, towels.	5,5 kg	Rinse hold, Night cycle plus, Pre-wash, Rinse plus, Time manager, Delay start
 Synthetics (cold - 60°) : Synthetic fabrics, body linen, fab, coloured fabrics, non-iron shirts, blouses.	2,5 kg	Rinse hold, Night cycle plus, Pre-wash, Rinse plus, Time manager, Delay start
 Delicates (cold - 40°) : For all delicate materials, for example curtains.	2,5 kg	Rinse hold, Night cycle plus, Pre-wash, Rinse plus, Time manager, Delay start
 Wool (cold - 40°) : Machine washable wool carrying the labels “pure new wool, machine washable, does not shrink”.	1,0 kg	Rinse hold, Night cycle plus, Delay start
 Silk (cold - 30°) : Fabric machine washable at 30°C.	1,0 kg	Rinse hold, Night cycle plus, Delay start

Programme / Type of washing	Load	Possible options
 Lingerie (cold - 40°) : For very delicate items, like lingerie.	1,0 kg	Rinse hold, Night cycle plus, Delay start
 Rinse : Hand washed items can be rinsed in this programme.	5,5 kg	Rinse hold, Night cycle plus, Rinse plus, Delay start
 Drain : Runs an empty cycle after a Rinse hold (or Night cycle plus).	5,5 kg	
 Spin : A spin cycle from 700 to 1000 rpm after a Rinse hold (or Night cycle plus).	5,5 kg	Delay start
 Eco¹⁾ (40° - 90°) : White or colour, e.g. normally soiled work clothes, bed linen, table linen, body linen, towels.	5,5 kg	Rinse hold, Night cycle plus, Prewash, Rinse plus, Delay start
 Easy iron (cold - 60°) : For washing cottons and synthetics. Reduces creasing and makes ironing easier.	1,0 kg	Rinse hold, Prewash, Rinse plus, Delay start
 Jeans : For washing denim clothes. The Rinse plus option is activated.	3,0 kg	Rinse hold, Night cycle plus, Prewash, Delay start
 Intensive sport : For dirty outside sport clothes. The Prewash option is activated.	2,5 kg	Rinse hold, Night cycle plus, Rinse plus, Delay start
 Sport : For sport clothes.	2,5 kg	Delay start

1) Reference programme for test confirming to CEI 456 standard : 46 L / 0,93 kWh / 190 min

CARE AND CLEANING

Unplug the appliance before cleaning.

Descaling the appliance

To descale the appliance, use an appropriate non-corrosive product designed for washing machines. Read product label for recommended amounts and how often descaling should be carried out.

The exterior

Use warm soapy water to clean the exterior of the appliance. Never use alcohol, solvents or similar products.

Dispenser box

To clean, proceed as follows :

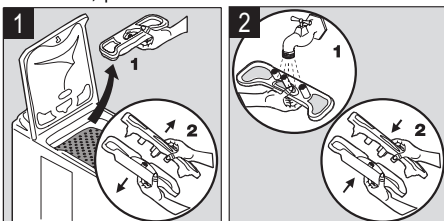

Drainage filter

Clean the filter located at the base of the appliance regularly :

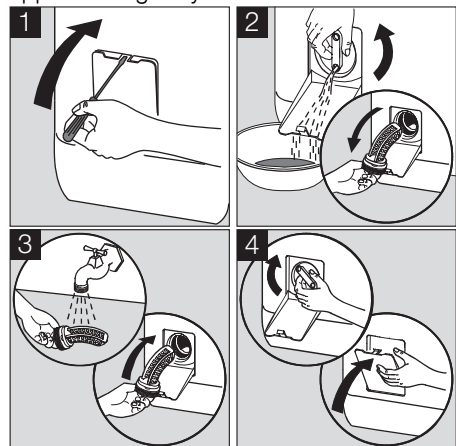

Water inlet filters

To clean, proceed as follows :

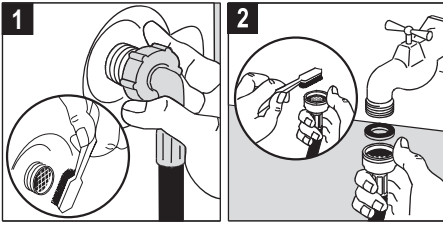

OPERATING PROBLEMS

Numerous checks were carried out on your appliance before it left the factory. However, should you notice a malfunction, please

refer to the sections below before contacting the after-sales service.

Problems	Causes
The washing machine doesn't start or doesn't fill :	<ul style="list-style-type: none"> • the appliance isn't plugged in correctly, the electrical installation isn't working, • the lid of your appliance and the drum shutters aren't closed firmly, • the programme start command hasn't been properly selected, • there is a power failure, • the water supply has been cut off, • the water inlet tap is closed, • the water inlet filters are dirty, • a red tab appears on the water inlet hose¹⁾.
The appliance fills but empties straight away :	<ul style="list-style-type: none"> • the drainage U-piece is fixed too low (see installation section).
The washing machine doesn't rinse or doesn't empty :	<ul style="list-style-type: none"> • the drain hose is blocked or bent, • the drainage filter is obstructed, • the out of balance detector has been activated : washing is unevenly distributed in the drum, • the "Drain" programme or "Night Silence Plus" or "Rinse hold" option have been selected, • the height of the drainage U-piece is unsuitable.
You have found water around the washing machine :	<ul style="list-style-type: none"> • too much detergent has caused foam to overflow, • the detergent is unsuitable for machine washing, • the drainage U-piece isn't attached correctly, • the drainage filter hasn't been put back in place, • the water inlet hose is leaking.
Wash is unsatisfactory :	<ul style="list-style-type: none"> • the detergent is unsuitable for machine washing, • there is too much washing in the drum, • the wash cycle is unsuitable, • there isn't enough detergent.
The appliance vibrates, is noisy :	<ul style="list-style-type: none"> • all packaging have not been removed from the appliance (see installation section), • the appliance isn't level and is unbalanced, • the appliance is too close to the wall or furniture, • washing is unevenly distributed in the drum, • the load is too small.

Problems	Causes
The wash cycle is much too long :	<ul style="list-style-type: none"> • the water inlet filters are dirty, • the power or water supply has been cut off, • the motor overheating detector has been activated, • the water inlet temperature is lower than usual, • the foam detection security system has been activated (too much detergent) and the washing machine has begun draining the foam, • the out of balance detector has been activated: an extra phase has been added to distribute washing more evenly in the drum.
The washing machine stops during a wash cycle :	<ul style="list-style-type: none"> • the water or electricity supply is defective, • a Rinse hold has been selected, • the drum shutters are open.
The lid doesn't open at the end of the cycle :	<ul style="list-style-type: none"> • the "immediate opening"¹⁾ light is not lit, • the temperature inside the drum is too high, • the lid unlocks 1 - 2 minutes after the end of the cycle¹⁾.
The E40 error code appears in the display ²⁾ and the "Start/Pause" pushbutton flashes red ³⁾ :	<ul style="list-style-type: none"> • the lid is not closed properly.
The E20 error code appears in the display ²⁾ and the "Start/Pause" pushbutton flashes red ³⁾ :	<ul style="list-style-type: none"> • the drainage filter is obstructed, • the drain hose is blocked or bent, • the drain hose is fixed to high (see "Installation" section), • the drainage pump is blocked, • the standpipes blocked.
The E10 error code appears in the display ²⁾ and the "Start/Pause" pushbutton flashes red ³⁾ :	<ul style="list-style-type: none"> • the water tap is closed, • the water supply has been cut off. • a red tab appears on the water inlet hose¹⁾.
The EF0 error code appears in the display ²⁾ and the "Start/Pause" pushbutton flashes red ³⁾ :	<ul style="list-style-type: none"> • the drainage filter is obstructed, • the anti-flooding security system has been activated, please proceed as follows : <ul style="list-style-type: none"> - close the water inlet tap, - empty the appliance for 2 minutes before unplugging, - call the after-sales service.
Softener runs directly into the drum when filling the dispenser box:	<ul style="list-style-type: none"> • you have gone past the MAX indicator.

1) Depending on model.

2) On some models, the audible signals can sound

3) After solving any problems, press "Start/Pause" pushbutton to restart the interrupted programme.

DETERGENTS AND ADDITIVES

Only use detergents and additives designed for use in a washing machine. We do not recommend mixing different types of detergents. This may spoil the washing. There are no restrictions on the use of powder detergents. Liquid detergents must not be used when a prewash or the reference pro-

gramme (see Programmes table) has been selected. For cycles without prewash, they must be added via means of a dosing ball. Detergent tablets or doses must be placed in the detergent compartment of your appliance's dispenser box.

TECHNICAL SPECIFICATIONS

DIMENSIONS	Height Width Depth	850 mm 400 mm 600 mm
LINE VOLTAGE /FREQUENCY POWER CONSUMPTION		230 V / 50 Hz 2300 W
WATER PRESSURE	Minimum Maximum	0,05 MPa (0,5 bar) 0,8 MPa (8 bar)
Connection to water supply		Type 20/27

INSTALLATION

Remove all protective packaging for transit before using for the first time. Keep in case needed for future transit: Transporting a non-secured appliance may damage internal components and cause leakages and malfunctions. The appliance can also be damaged through physical contact.

Unpacking

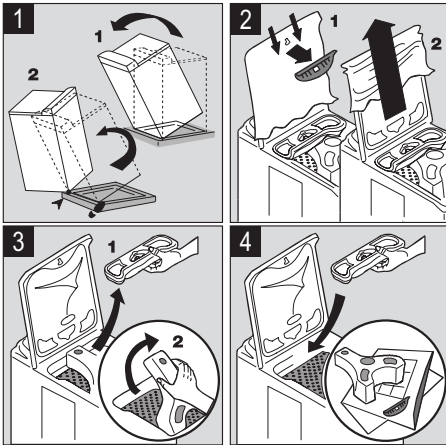

Untying

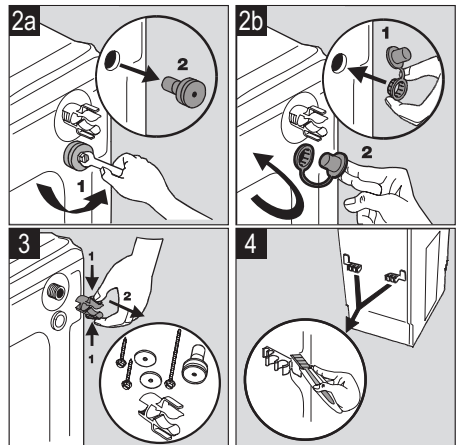
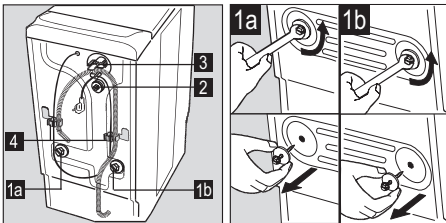

To install your washing machine at the same level as surrounding furniture, proceed as shown on picture 4.

Water supply

Install the supplied water inlet hose at the rear of your washing machine by proceeding as follows. Do not reuse an old hose. The water inlet hose can not be extended. If it is too short, please contact the after-sales service.

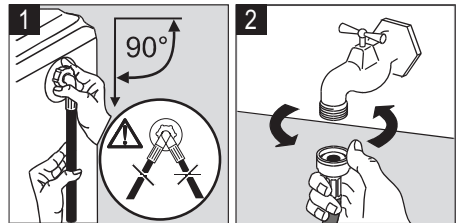

Open the water inlet tap. Check there are no leaks.

Drainage

Fit the U-piece on the drainage hose. Place everything in a drainage point (or in a sink) at a height of between 70 and 100 cm. Ensure it is positioned securely. Air must be able to enter the end of the hose, to avoid any risk of siphoning. The drain hose must never be stretched. If it is too short, contact an engineer.

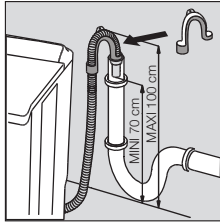

Electrical connection

This washing machine must only be connected in single-phased 230 V. Check the fuse size: 13 A for 230 V. The appliance must not be connected with an extension lead or multi-plug adaptor. Ensure that the plug is earthed and that it is in accordance with current regulations.

Positioning

Position the appliance on a flat and hard surface in a ventilated location. Ensure the

appliance does not come into contact with the wall or other furniture. To move your appliance, proceed as follows:

Place it on its rollers by pulling the lever located at the base of the appliance hard from right to left.

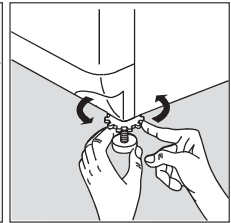
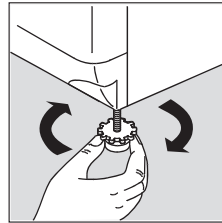
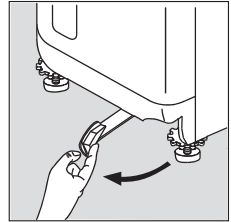

Once the appliance is in the desired position, push the lever back to its original position. Accurate levelling avoids vibrations, noise and prevents the appliance from moving when running.



ENVIRONMENT CONCERNS

The symbol  on the product or on its packaging indicates that this product may not be treated as household waste. Instead it should be taken to the appropriate collection point for the recycling of electrical and electronic equipment. By ensuring this product is disposed of correctly, you will help prevent potential negative consequences for the environment and human health, which could otherwise be caused by inappropriate waste handling of this product. For more detailed information about recycling of this product, please contact your local council, your household waste disposal service or the shop where you purchased the product.

Disposing of the appliance

 All materials carrying the  symbol are recyclable. Dispose of them at a waste

collection site (enquire at your local council) for collection and recycling. When disposing of your appliance, remove all parts which could be dangerous to others: cut off the power supply cable at the base of the appliance.

Protecting the environment

-  To save water and energy and therefore help protect the environment, we recommend the following:
 - Whenever possible, use the appliance at full capacity and avoid partial loads.
 - Only use the prewash and soak programmes for heavily soiled items.
 - Use an appropriate amount of detergent for the hardness of the water, the size of the load and how soiled the washing is.



www.electrolux.com/shop

