

(English)
Ver. 1.0

MULTI FAN CONTROLLER

ZM-MFC2

User's Manual



Please visit our website(www.zalman.co.kr/www.zalmanusa.com) and watch the ZM-MFC2 installation video to assist you in the installation process.

- ※ Please read this manual thoroughly before installation.
- ※ The specifications of the product may change without any prior notice to improve performance.

ZALMAN
COOL INNOVATIONS

Safety Precautions

- The following precautions and directions are measures against possible accidents and injuries. Please read them thoroughly before using this product.



Warning

Neglecting the following may cause serious injury or death.

- ▶ Opening the cover of the product while the power cord is plugged into the Current/Voltage Sensor (CVS) may cause electrocution of the user or critical damage to the product.
- ▶ Handling the power cord with wet hands may cause electrocution.
- ▶ During heavy lightning storms, unplug the main power cord from the CVS to prevent possible system damage and fire hazards.
- ▶ Plugging in the CVS Cable of the CVS into the motherboard's USB port may damage the motherboard and CVS.
- ▶ If the current to be measured exceeds 10A (RMS), use a cable or conductor that allows current greater than the current to be measured to flow through it, and always connect protective grounding prior to use of this instrument.



Caution

Neglecting the following may cause minor injuries, degrade product conditions, or cause malfunction.

- ▶ Operating the product in an extremely cold or hot environment can degrade product performance and life span.
- ▶ Allowing liquids to enter the product can result in malfunction.
- ▶ Operating in a humid or non-ventilated environment can reduce product life span.
- ▶ Do not place heavy objects on top of the CVS.
- ▶ Must use a well wrung-out cloth to clean the CVS.
- ▶ Using the product for purposes not specified by ZALMAN may cause damage to other devices connected to this product.
- ▶ Must be installed on an easily reachable location.

Symbols



Alternating current



Caution, risk of electric shock



CE mark



Nationally Recognized Testing Laboratory mark



Protective conductor terminal



Caution, risk of danger



Federal Communications Commission (FCC) mark



Restriction of Hazardous Substances (RoHS) mark

Environmental Conditions

This product must be used under the following environmental conditions:

- Indoor use;
- Altitude up to 2,000m;
- Temperature 5 °C to 40 °C;
- Maximum relative humidity 80% for temperatures up to 31 °C decreasing linearly to 50% relative humidity at 40 °C;
- MAINS supply voltage fluctuations up to $\pm 10\%$ of the nominal voltage.

Features

1. Real time display of power consumption.
2. Four sensors for temperature monitoring and display.
3. Monitoring and control of one PWM fan and three standard fans.
4. Alarm system to notify non-operation of any of the fans.
5. Fan's operation status indicated with animated propeller images.

Components

1. One ZM-MFC2
2. One CVS (Current/Voltage Sensor)
3. One Bracket / CVS Extension Cable
4. Four Temperature Sensors
5. Fan Cables - 3-Pin 2EA, 4-Pin 1EA, Y-Cable 1EA
6. Four ZM-MFC2 Installation Bolts
7. One Bracket Installation Bolts
8. One User's Manual

ZM-MFC2 Specifications

Dimensions		147 x 87 x 42 (mm)
Power & Temperature Display		30~800W/ -9°C ~ +99°C
Fan Compatibility		1 X 4-Pin (Supports fans with PWM function)
		3 X 3-Pin (Supports fans with RPM output function)
Fan RPM Control	60~5940rpm	PWM Regulation Method (Fan No.4)
		Voltage Control Method (Fan No.1~3)
Output Current		0.7A
Output Voltage		4~11V
Input Voltage		12VDC/+5VDC

CVS Specifications

Input	100-240V~, 50/60 Hz, 10A
Bypass Output	100-240V~, 50/60Hz, 10A
Output	5V~, 0.03A

Front Panel

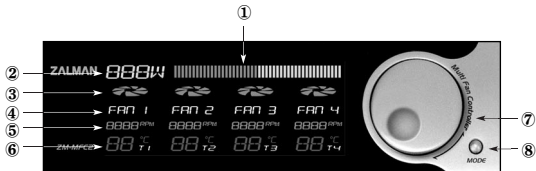

- ① Graphic Power Load Meter: Displays power between 30 to 800W in 4 stages.
- ② Numeric Power Load Display: Numerically displays power between 30 and 800W.
(The Numeric Power Load Display will read "LLL" when an overflow occurs. "LLL" indicates power loads beyond the unit's measurable range.)
- ③ Fan Status Display: The Fan's operation status is indicated with animated propeller images.
- ④ Fan Channels
- ⑤ RPM Display: During RPM Setting, RPM is displayed in units of 60RPM, and actual operational RPM is displayed in units of 10RPM.
- ⑥ Temperature Display: Displays temperature readings between -9°C and +99°C
- ⑦ Jog Wheel: Used for adjusting Fan RPM. RPM can be set from 1000 to 5940RPM in units of 60RPM.
- ⑧ Mode Button: Used for selecting a Fan Channel and saving the Fan RPM setting.

Back Panel

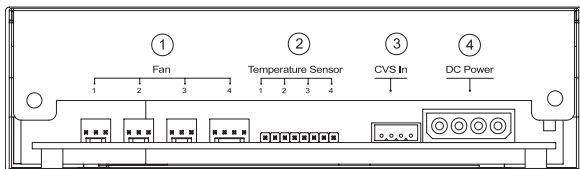

- ① Standard Fans (Fan 1~3): 3-Pin fans that include the RPM output function can be connected for use.
PWM Fan (Fan 4): 4-Pin fan that includes the PWM function can be connected for use.
- ② Temperature Sensing: Four temperature sensors can be connected.
- ③ CVS Terminal: Receives the measured values of the CVS.
- ④ Power Connector: Connects with the PSU's 4-Pin connector.

Installation

1. Turn the computer's power OFF and unplug the Main Power Cord before installing ZM-MFC2.

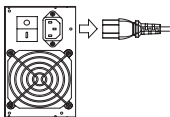

2. Install the ZM-MFC2 into a 5.25" ODD bay as shown in the diagram.

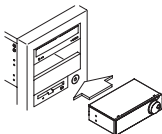

3. Fix it in place with the use of Bolts.

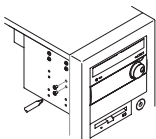

4. Connect the Power Cable and Fan Cables to ZM-MFC2.

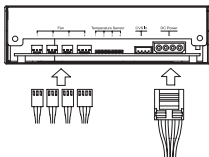

5. Connect the Temperature Sensor's plug to ZM-MFC2, and attach the sensors to desired locations.

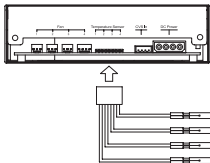

6. Install the Bracket in the Enclosure, and connect the CVS Extension Cable to ZM-MFC2.

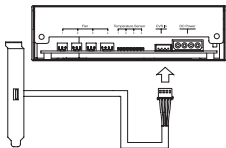

7. Connect the CVS's CVS Cable to the Bracket.

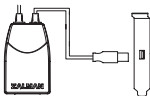

8. Connect the CVS's AC Power Cord to the PSU.

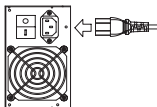

9. Connect the Main Power Cord to the CVS.



Connections

Power Supply

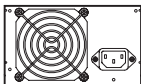

ZM-MFC2

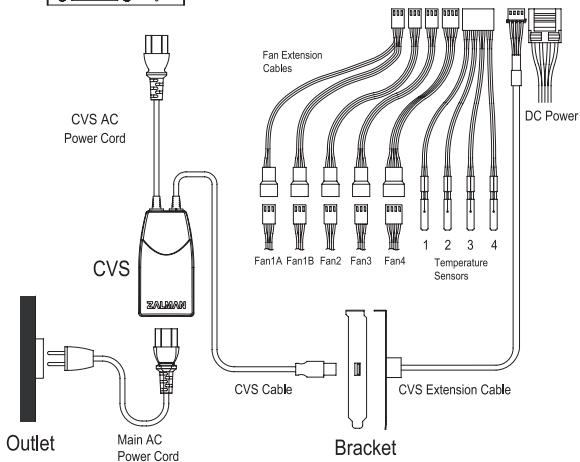
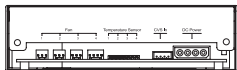

* The Main AC Power Cord is not provided with ZM-MFC2.

Operational Guidelines

- Four channels of ZM-MFC2 detect fan RPM signals.
- The Alarm will activate if a fan is not connected or if there is no RPM input signal for any of the channels.
- To deactivate the Alarm, the Stand-By Mode (default setting: ON) of each unused channel must be deactivated.

1. Selecting a Channel/Deactivating Stand-By Mode

- (1) Select a channel with the Mode Button (The selected channel will begin to flicker).
- (2) Press the Jog Wheel to deactivate the selected channel's Stand-By Mode. The fan image will turn off.
- (3) Deactivate the Stand-By Mode of all unused channels as mentioned above.

Note: Deactivating the Stand-By Mode of all the channels will not deactivate other functions (Channel Output, RPM Display, RPM Setting & Saving etc.)

2. RPM Setting and Saving

- (1) Select a channel with the Mode Button.
- (2) Set the RPM with the Jog Wheel. (Turning the Jog Wheel in clockwise motion will increase the RPM, and turning it counter-clockwise will decrease the RPM)
- (3) Press the Mode Button again to save the set value and to select the next channel.
(If nothing is input for 5 seconds, the ZM-MFC2 will automatically save the latest setting and leave the Setting Mode).

3. Initializing to Default Settings

Press the Mode Button for 3 seconds. (The entire display will be on for 1 second and all fans will be set to 1500 RPM)

Y-Cable Guidelines

Use of the Y-cable allows the operation of 2 fans with 1 channel.

Please read the following guidelines carefully before use.

- (1) A 3-pin fan must be connected to the White Housing.
- (2) The second fan must be connected to the Blue Housing.
- (3) The fan speed cannot be controlled if a fan is connected to the Blue Housing with no fan connected to the White Housing.
- (4) The fan speed is controlled according to the speed of the fan connected to the White Housing, and the specifications of the two fans must be identical.

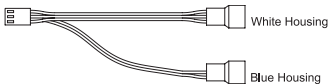

Items to Check Before Reporting for Malfunction

1. Check to see that the CVS is properly connected to the ZM-MFC2 and PSU.
2. Check to see that all the cables are connected properly.
3. Check to see if pressing the Mode Button initializes the device to default settings.
4. Check the fans' specifications.
 - (1) The RPM of 2-Pin Fans that do not output RPM signals cannot be controlled. Must use 3-Pin Fans that output 2 clock pulses for each round.
 - (2) Connecting a 3-Pin Fan to the PWM 4-Pin connector will not allow RPM control.
5. If there are any problems with the fan, then noise will interfere with the RPM clock waves. This disrupts accurate RPM control.
6. Fan RPM cannot be set higher than the fan's specified value. If using a 3000RPM fan, then setting it to 5000RPM will not cause the fan to operate at 5000RPM.
7. For fans with a specified minimum RPM, if the fan is set to a low RPM, there may be cases in which the fans stop and restart rotating. This is not a defect of ZM-MFC2. You must set the RPM higher than the specified minimum RPM of the fan.

Zalman's CNPS (Computer Noise Prevention System) Products

For a stable and noiseless system of the highest quality, use Zalman's Ultra Quiet CPU Coolers, Ultra Quiet VGA Coolers, Ultra Quiet Power Supplies, Heatpipe HDD Cooler, Fanless Northbridge Coolers, and Noiseless Case Fans.



Ultra Quiet CPU Cooler
CNPS9700 LED



Ultra Quiet VGA Cooler
VF900-Cu LED



Ultra Quiet Power Supply
ZM600-HP



Fanless Northbridge Cooler
ZM-NBF47



Silent Case Fan
ZM-F1, F2, F3



Heatpipe HDD Cooler
ZM-2HC2

International Safety and EMC Certifications

This device complies with part 15 of the FCC Rules. Operation is subject to the following two conditions: (1) This device may not cause harmful interference, and (2) this device must accept any interference received, including interference that may cause undesired operation.

Product Warranty (International)

Thank you for purchasing Zalman's product.

Warranty - If this product has any defects, then Zalman guarantees that it can be exchanged within one (1) year from the time of purchase.

* Product exchange is made with the reseller where the product was purchased.

For further inquiries, contact Zalman headquarters at www.zalman.co.kr or via e-mail to a representative.

There will be no exchanges in the following cases:

- A) Violation of the Safety Precautions and the instructions in this manual.
- B) Human fatality and/or property damage due to events of natural causes.
- C) External case damage, electrical problems, and damage to components caused by careless mishandling.

Disclaimer

Zalman Tech Co., Ltd. is not responsible for any damages due to external causes, including but not limited to, improper use, problems with electrical power, accident, neglect, alteration, repair, improper installation, or improper testing.

Contact Information

< Zalman Tech Co., Ltd. >
Homepage : www.zalman.co.kr
E-mail : zalman@zalman.co.kr

< Zalman USA Inc. >
Homepage : www.zalmanusa.com
E-mail : support@zalmanusa.com



Disposal of Old Electrical & Electronic Equipment
(Applicable in the European Union and other European countries with separate collection systems)