

DC260

Visual Presenter

User Manual

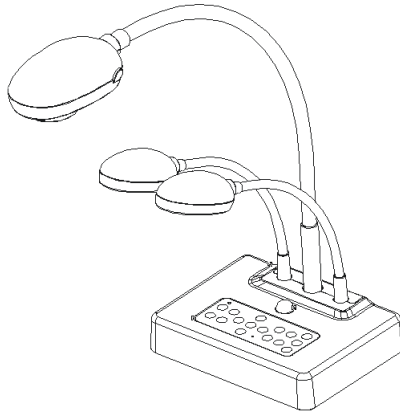

[Important]

To download the latest version of Quick Start Guide, multilingual user manual, software, or driver, etc., please visit Lumens
<http://www.lumens.com.tw/goto.htm>

Contents

Copyright Information	3
Chapter 1 Precautions	4
Chapter 2 Package Content	7
Chapter 3 Product Overview	8
3.1 Relative position of the presenter and DC260	9
3.2 Recommend distance.....	9
3.3 Incorrect use.....	10
Chapter 4 Installation and Connections	11
4.1 System diagram	11
4.2 Mounting the DC260 at desktop.....	12
4.3 Connecting devices	12
4.4 Start using the DC260	16
4.5 Installing remote control holder	16
4.6 Installing driver and application queue.....	17
Chapter 5 DIP Switch Settings	21
5.1 Connecting to a projector or monitor	21
5.2 Connecting to a TV.....	22
Chapter 6 Control Panel/Remote Control and Setting Menu	23
6.1 Functions of control panel and remote control	23
6.2 Setting Menu	25
Chapter 7 Descriptions of major functions	31
7.1 I would like to switch image sources	31
7.2 I would like to make text clearer and photos more colorful	31
7.3 I would like to zoom in /out of images	31
7.4 I would like to use the auto focus	32
7.5 I would like to adjust the brightness	32
7.6 I would like to turn on/ off the lamp.....	32

7.7	I would like to automatically adjust the image to have best brightness and focusing performance	32
7.8	I would like to capture images	32
7.8.1	Setting the quality of captured images	32
7.8.2	Setting continuous capture	33
7.8.3	Capturing and saving images	33
7.9	I would like to view captured images	33
7.10	I would like to delete captured images	33
7.11	I would like to automatically delete the captured images whenever it is turned off (Auto Erase)	34
7.12	I would like to record and play videos	34
7.13	I would like to switch the view between the upper and lower half of the image (Half Page)	35
7.14	I would like to play the slides (Slide Show)	35
7.15	I would like to compare images (Compare live images with captured images) (PBP, Picture by Picture)	36
7.16	I would like to resume the factory default setting (Factory Reset)	37
7.17	I would like to reduce the image noise (Noise Reduction)	37
7.18	I would like to set / change the password (Lock Down)	38
7.19	Using a SD card	39
7.20	Computer-related functions	40
7.20.1	I would like to insert a photo in <i>MS-Paint</i>	40
7.20.2	I would like to insert a photo in <i>MS-Word</i>	41
7.20.3	I would like to change the setting of DC260 then capture a photo in <i>MS-Word</i>	42
7.20.4	I would like to set the DC260 as a <i>webcam</i> for <i>Skype</i>	43
7.20.5	I would like to set the DC260 as a <i>PC Camera</i>	44
7.20.6	I would like to set the DC260 as a <i>Removable Disc</i>	45
7.20.7	I would like to connect Interactive Whiteboard	46
Chapter 8	Connecting to Microscope	48
Chapter 9	Troubleshooting	50

Copyright Information

Copyrights © Lumens Digital Optics Inc. All rights reserved.

Lumens is a trademark that is currently being registered by Lumens Digital Optics Inc.

Copying, reproducing or transmitting this file is not allowed if a license is not provided by Lumens Digital Optics Inc. unless copying this file is for the purpose of backup after purchasing this product.

In order to keep improving the product, Lumens Digital Optics Inc. hereby reserves the right to make changes to product specifications without prior notice. The information in this file is subject to change without prior notice.

To fully explain or describe how this product should be used, this manual may refer to names of other products or companies, nevertheless without any intention of infringement.

Disclaimer of warranties: Lumens Digital Optics Inc. is neither responsible for any possible technological, editorial errors or omissions, nor responsible for any incidental or related damages arising from providing this file, using, or operating this product.

Chapter 1 Precautions

Always follow these safety instructions when setting up and using the visual presenter:

1. Do not place visual presenter in tilted position.
2. Do not place the visual presenter on an unstable trolley, stand or table.
3. Do not use the visual presenter near water or source of heat.
4. Use attachments only as recommended.
5. Use the type of power source indicated on the visual presenter. If you are not sure of the type of power available, consult your dealer or local electricity company for advice
6. Place the visual presenter on a place that it can be unplugged easily.
7. Always take the following precautions when handling the plug. Failure to do so may result in sparks or fire.
 - Ensure the plug is free of dust before inserting it into a socket.
 - Ensure that the plug is inserted into the socket securely.
8. Do not overload wall sockets, extensions leads or multi-way plug boards as this may cause fire or electric shock.
9. Do not place the visual presenter where the cord can be stepped on as this may result in fraying or damage to the lead or the plug.
10. Unplug the projector from the wall socket before cleaning. Use a damp cloth for cleaning. Do not use liquid or aerosol cleaners.
11. Do not block the slots and openings in the projector case. They provide ventilation and prevent the visual presenter from overheating. Do not place the visual presenter on a sofa, rug or other soft surface or in a built-in installation unless proper ventilation is provided.
12. Never push objects of any kind through cabinet slots. Never allow liquid of any kind to spill into the visual presenter.
13. Except as specifically instructed in this User Manual, do not attempt to operate this product by yourself. Opening or removing covers may expose you to dangerous voltages and other hazards. Refer all servicing to licensed service personnel.
14. Unplug the visual presenter during thunderstorms or if it is not going to be used for an extended period, do not place the visual presenter or remote control on top of heat-emitting equipment or heated objects such as a car and etc.





15. Unplug the visual presenter from the wall outlet and refer serving to licensed service personnel when the following situations happen:
 - If the power cable or plug becomes damaged or frayed.
 - If liquid is spilled into it or the visual presenter has been exposed to rain or water.

<Note> Using an incorrect battery type in the remote control may result in breakdown. Follow your country’s instructions on how to dispose of used batteries.

■ Safety Precautions

Warning: To reduce the risk of fire or electric shock, do not expose this appliance to rain or moisture.

This visual presenter has a 3-wire AC line Plug. This is a safety feature to ensure that the plug will fit into the power outlet. Do not try to disable this safety feature. If the visual presenter will not be used for a long period of time unplug it from the power outlet.

	CAUTION RISK OF ELECTRIC SHOCK	
<p>Caution: To reduce the risk of electric shock. Do not remove cover (or back). No user-serviceable parts inside. Refer servicing to licensed service Personnel.</p>		
	<p>This symbol indicates that this equipment may contain dangerous voltage which could cause electric shock.</p>	
		<p>This symbol indicates that there are important operating and maintenance instructions in this User Manual with this unit.</p>

■ FCC Warning

NOTE: THE MANUFACTURER IS NOT RESPONSIBLE FOR ANY RADIO OR TV INTERFERENCE CAUSED BY UNAUTHORIZED MODIFICATIONS TO THIS EQUIPMENT. SUCH MODIFICATIONS COULD VOID THE USER'S AUTHORITY TO

OPERATE THE EQUIPMENT.

Note: This equipment has been tested and found to comply with the limits for a Class A or B digital device, pursuant to Part 15 of FCC Rules. These limits are designed to provide reasonable protection against harmful interference in a residential installation. This equipment generates uses and can radiate radio frequency energy and, if not installed and used in accordance with the instruction, may cause harmful interference to radio communications. However, there is no guarantee that interference will not occur in a particular installation. If this equipment does cause harmful interference to radio or television reception, which can be determined by turning the equipment off and on, the user is encouraged to try to correct the interference by one or more of the following measures:

- Reorient or relocate the receiving antenna.
- Increase the separation between the equipment and receiver.
- Connect the equipment into an outlet on a circuit different from that to which the receiver is connected.
- Consult the dealer or an experienced radio/TV technician for help.

Notice:

- (1) A Unshielded-type power cord is required in order to meet FCC emission limits and also to prevent interference to the nearby radio and television reception. It is essential that only the supplied power cords by used.
- (2) Use only shielded cables to connect I/O devices to this equipment.
- (3) Changes or modifications not expressly approved by the party responsible for compliance could void the user's authority to operate the equipment.

■ EN55022 (CE Radiation) Warning

This product is intended for use in a commercial, industrial, or educational environment. It is not intended for residential use.

This is a Class A product. In a domestic environment it may cause radio interference, in which case the user may be required to take adequate measures. The typical use is in a conference room, meeting room or auditorium.

Chapter 2 Package Content

DC260

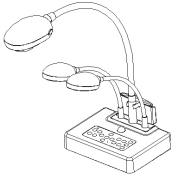

Base Installation
Guide



Software Bag



C-Video Cable



Padded Carry Bag
(Optional)



Quick Start Guide



Remote Control



VGA Cable



Remote Control
Holder

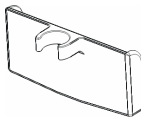

RS232 Adaptor
(Optional)



User Manual

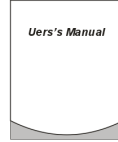

Power Cord

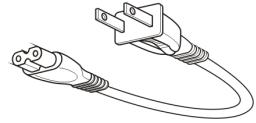

Appearance may vary with
country/region.

USB Cable



Microscope Adaptor

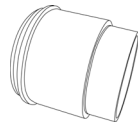

Chapter 3 Product Overview

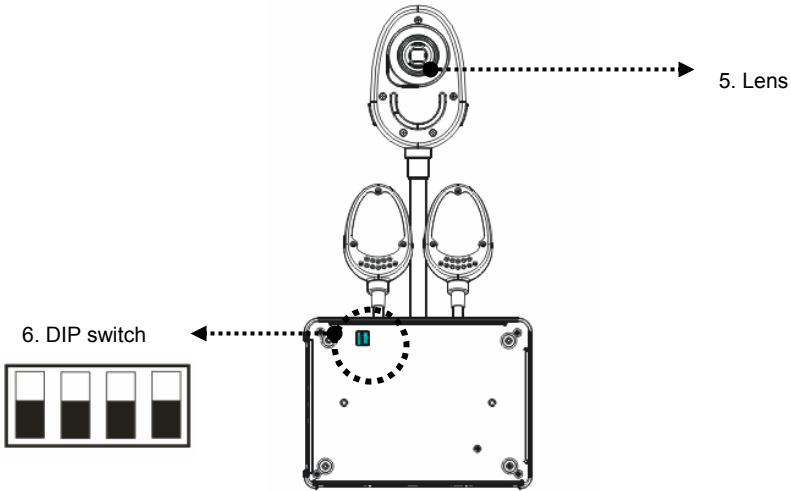
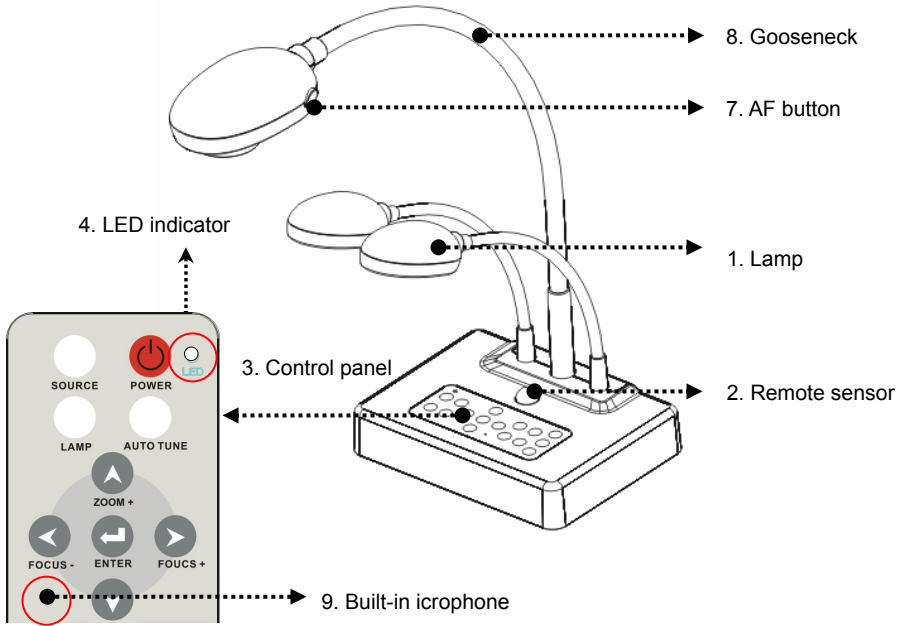

(Bottom)

3.1 Relative position of the presenter and DC260

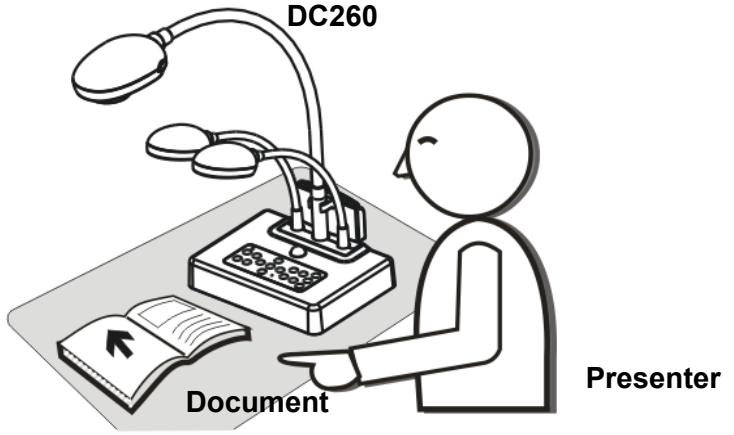

3.2 Recommend distance

About 470mm distance between camera and the desktop is recommended.

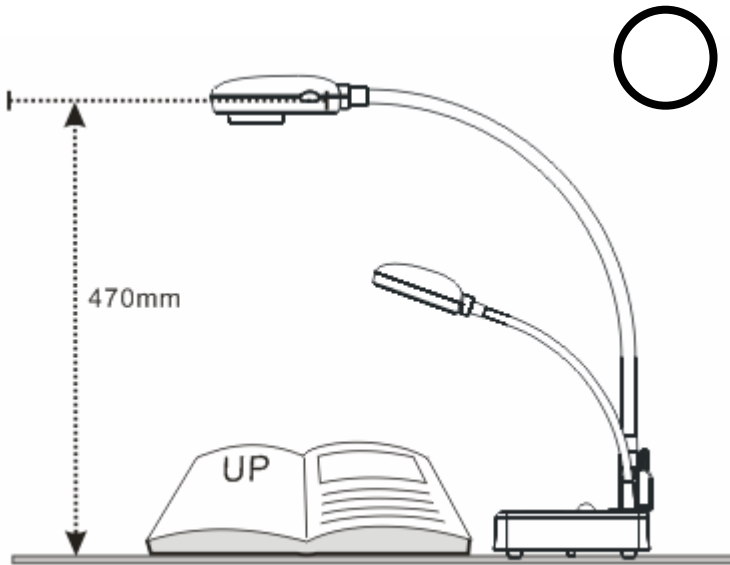

3.3 Incorrect use

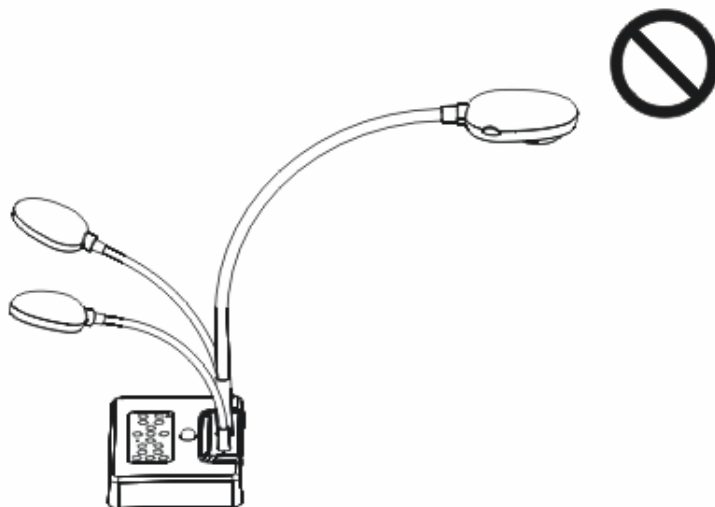
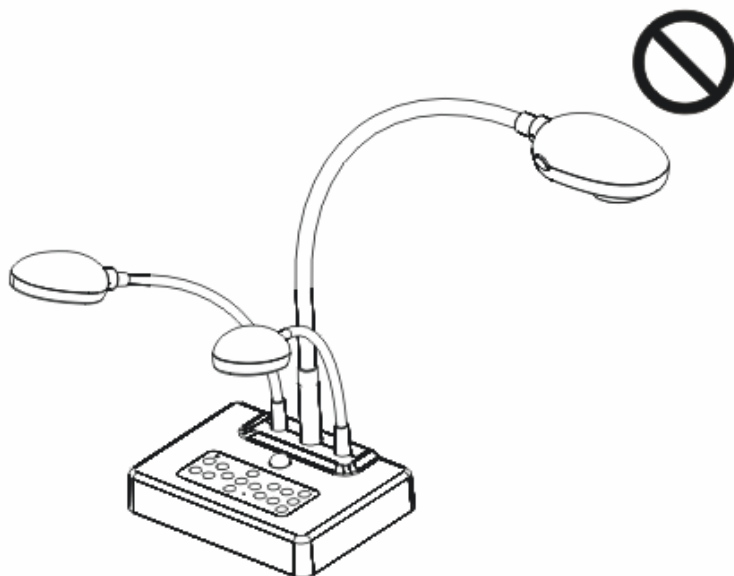

Chapter 4 Installation and Connections

4.1 System diagram

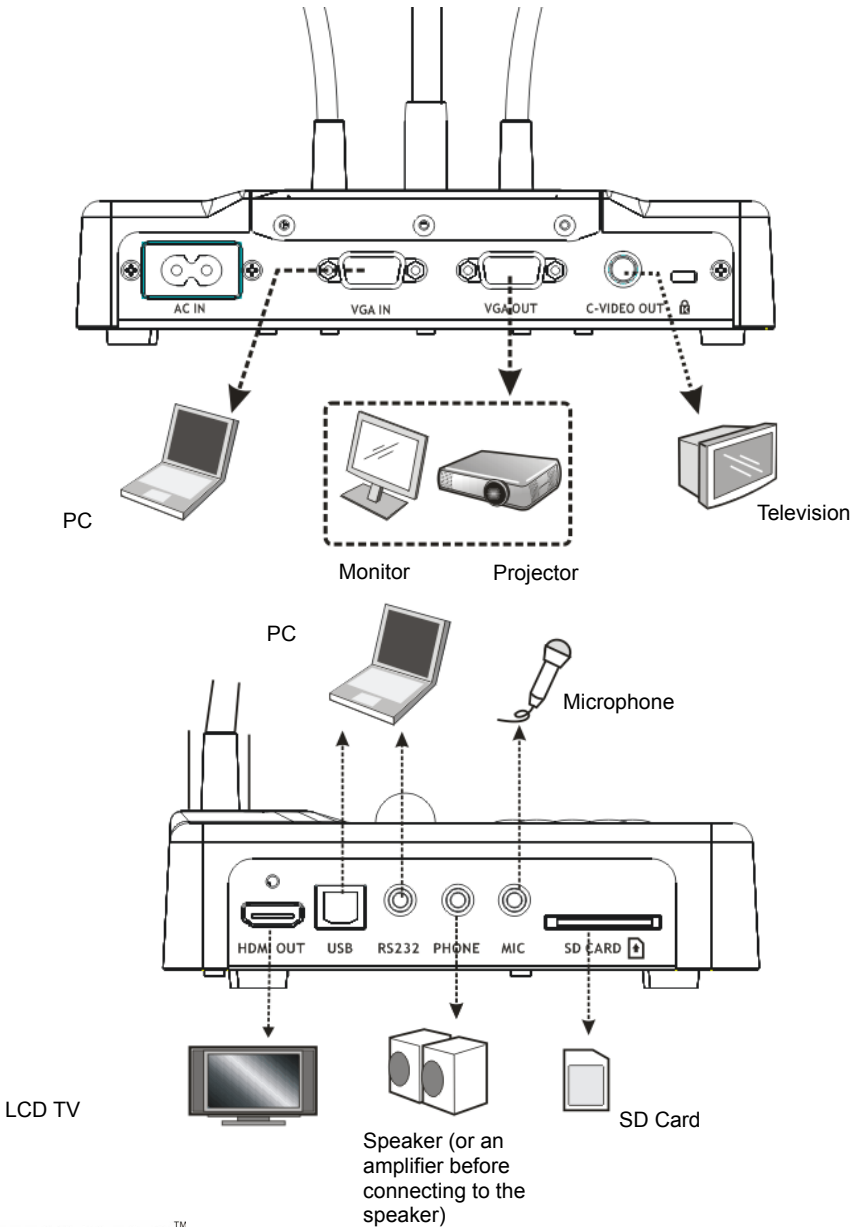

4.2 Mounting the DC260 at desktop

1. Please set up the DIP Switch settings first. Refer to [Chapter 5 “DIP Switch Settings”](#) in the DC260 user manual.
2. Please refer to the [Base Installation Guide](#) for installation instructions for all parts.

4.3 Connecting devices

4.3.1 Step 1: Plugging in the power outlet

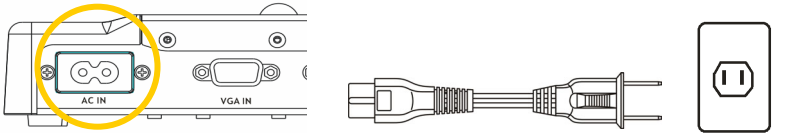

<Note> Appearance of power cord may vary with countries/regions.

4.3.2 Step 2: Connecting with components

➤ Connecting to a projector or monitor

- Use VGA cable to connect VGA OUT connector on DC260 to a projector or the VGA IN connector on a monitor.

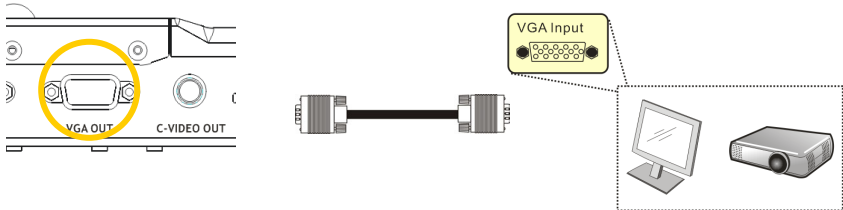

➤ Connecting to a TV

1. Use **C-Video** cable to connect TV.

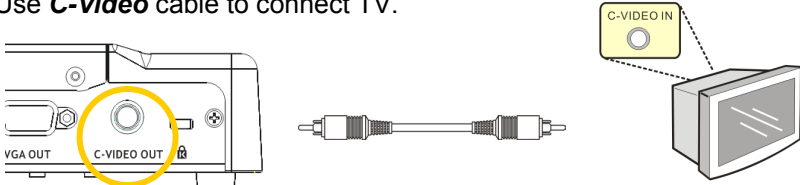

2. Adjust DIP Switch Setting

- NTSC: America, Taiwan, Panama, Philippine, Canada, Chile, Japan, Korea and Mexico

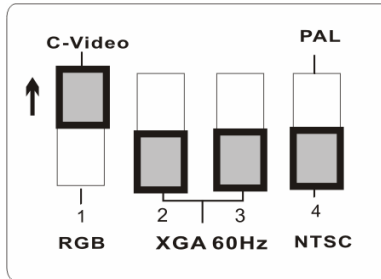

- PAL: Country/region not listed above:

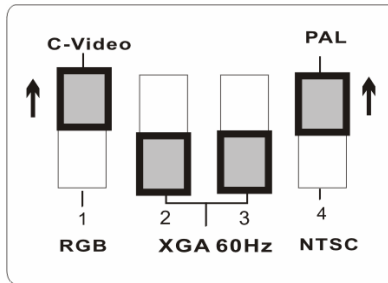

<Note> You are unable to use the [Menu] / [Rotate] / [Half Page] / [Source] / [Record] / [Capture] / [Delete] / [PBP] / [Slide Show] functions in C-Video mode.

<Note> VGA output is not supported once C-Video output enabled.

3. Restart the DC260

DIP Switch setting will not be available until restarting the DC260.

➤ **Connecting to a LCD TV/ PDP**

- Using the HDMI cable to connect a LCD TV/ PDP

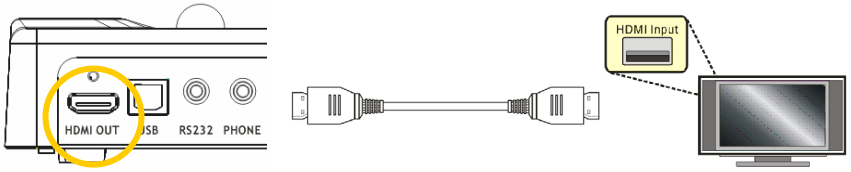

➤ **Connecting to a computer**

- Use VGA cable to connect VGA IN connector on DC260 to the VGA OUT connector on the computer

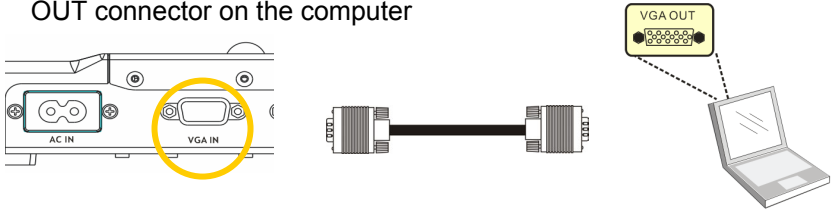

- Connecting to a computer through USB

Connect to USB port. Then install the supplied queue program. Please refer to [DC260 User Manual 4.6 Installing driver and application queue.](#)

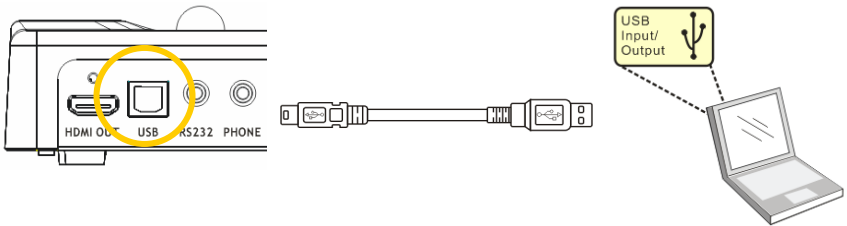

- Connecting to a computer through RS232 (RS232 Adapter is optional)

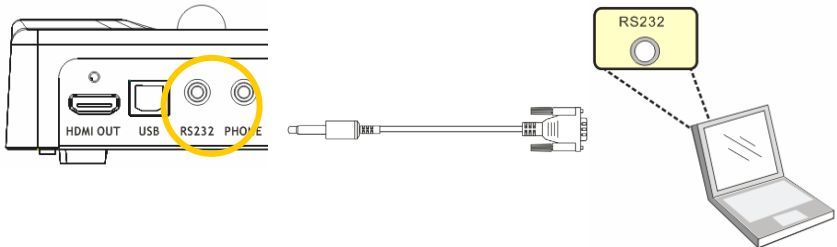

➤ **Connecting to speaker**

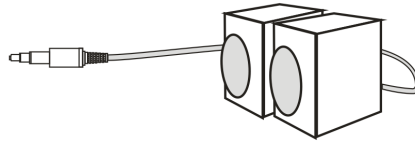
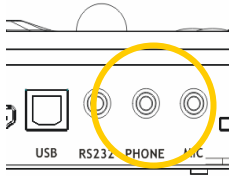

Speaker

<Remark>: Or connect to an additional amplifier before connecting to the speaker

➤ **Connecting to microphone**

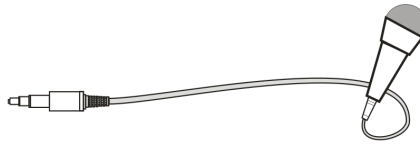

Microphone

4.4 Start using the DC260

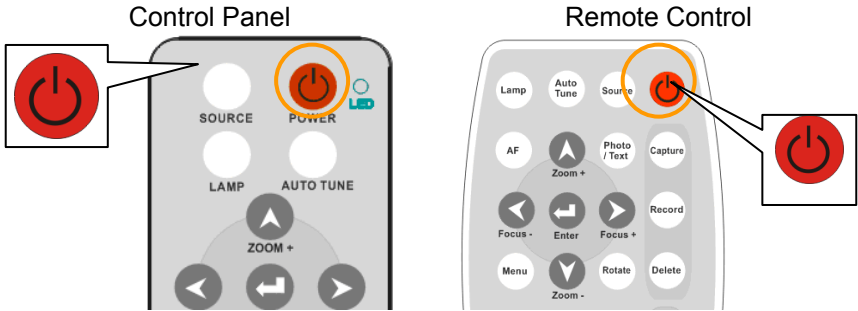

- When using the **remote control**, aim at the receptor on the DC260, and press the power button.
- Once DC260 is turned on, the LED on the **control panel** will flash a few times and stay lit. Please contact your distributor if the LED is not on.

<Note> Once the password page is shown , please key in the password. If you forget it, please contact your distributor or the service center.

4.5 Installing remote control holder

Insert the holder over the gooseneck of the camera and push it down.

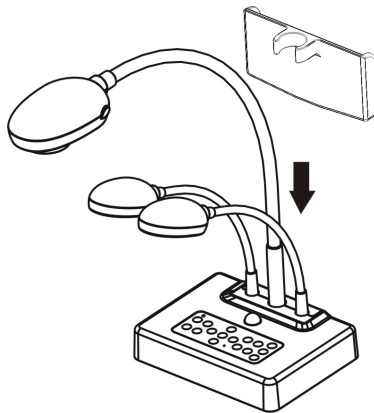

4.6 Installing driver and application queue

After installing the USB driver and application queue, you can use the following functions via the software:

- Control the DC260.
- Capture and record images.
- Annotate the image, highlight important details and save it.
- Supports the full screen function.

4.6.1 System requirements

Operating System	<i>Windows XP</i>	<i>Windows Vista</i>	<i>MAC OS X v10.4.10, v10.5</i>
Minimum System Requirements	<ul style="list-style-type: none">● CPU: P4 2.8 GHz and above● Memory: 512MB● Support Direct X 9● Resolution: 1024x768● Minimum Hard Disc Space Required: 100MB	<ul style="list-style-type: none">● CPU: P4 2.8 GHz and above● Memory: 1GB● Support Direct X 9● Resolution: 1024x768● Minimum Hard Disc Space Required: 100MB	<ul style="list-style-type: none">● CPU: PowerPC G4 866MHz or Intel Pentium® 1.83GHz Intel Core 2 Duo processor● Memory: 512MB● 1,024x768 screen resolution and 24-bit color display● Minimum Hard Disc Space Required: 1GB● QuickTime 7.4.5 above

4.6.2 Installation steps (PC)

1. Please download the software queue at the following URL:
<http://www.lumens.com.tw/goto.htm>
2. Refer to [Chapter 4 Installation and Connections](#) for USB connection.
3. Turn on the DC260.
4. Select the preferred language and press [**Next**]

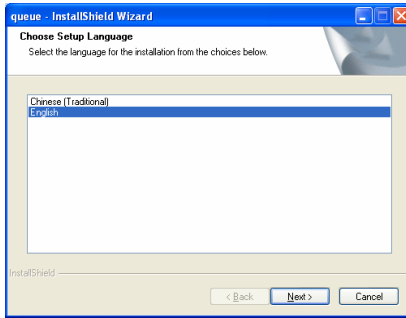

5. Select the preferred language and press **[Next]**.

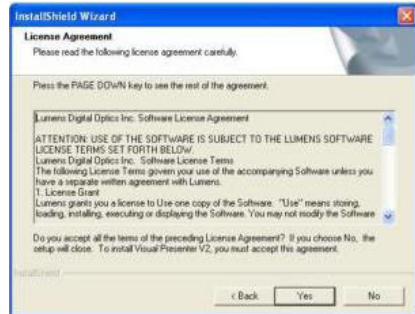
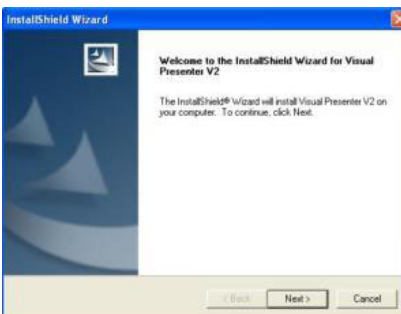
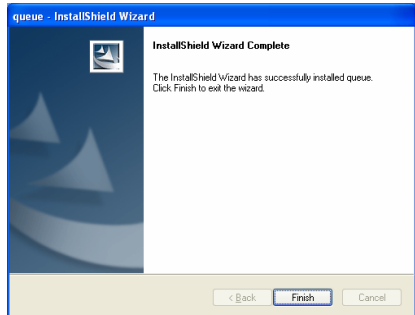
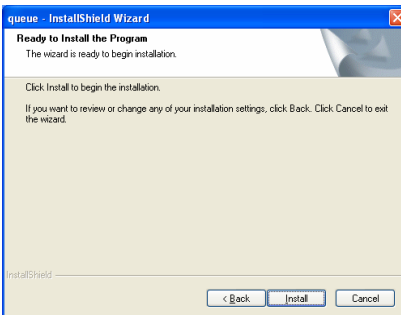
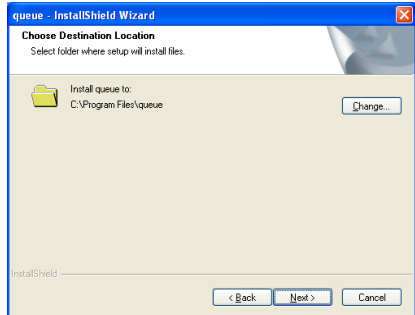
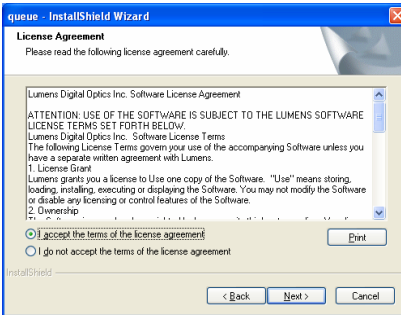

6. Please select Continue



7. Once the installation is completed, press [Finish] to reboot the system.

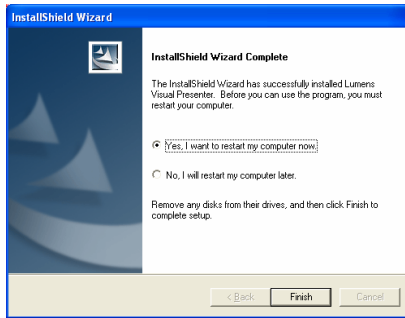

4.6.3 Installation steps (MAC)

1. Please download the software queue at the following URL:
<http://www.lumens.com.tw/goto.htm>
2. Refer to **[Chapter 4 Installation and Connections](#)** for USB connection.
3. Turn on the DC260.
4. Select [queue] to begin installation and follow the screen instructions

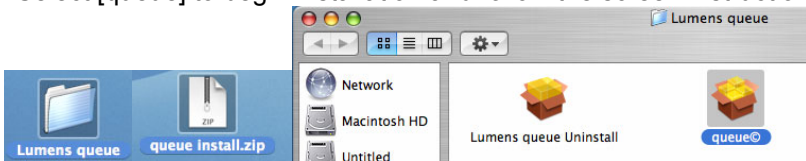

4.6.4 Verifying the installation is completed (PC)

1. Double click the **queue** shortcut on the desktop or click **[Program] > [Start] > [Programs] > [queue]**



<Remark> Please refer to the User Manual of queue for how to use it.
(Please download it from the website below
<http://www.lumens.com.tw/goto.htm>).

4.6.5 Verifying the installation is completed (MAC)

1. Click **[Applications] > [queue]**



<Remark> Please refer to the User Manual of queue for how to use it.
(Please download it from the website below
<http://www.lumens.com.tw/goto.htm>).

Chapter 5 DIP Switch Settings

<Note> You have to reset the unit for setting to take affect.

5.1 Connecting to a projector or monitor

5.1.1 XGA 60Hz output (default values):

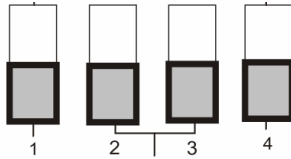

5.1.2 SXGA 60 Hz output

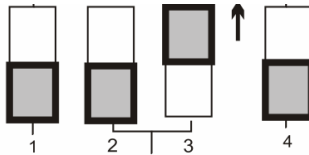

5.1.3 HDTV 720P 50Hz output

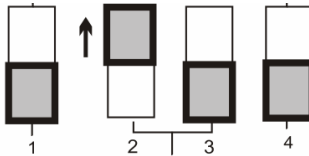

5.1.4 HDTV 720P 60Hz output

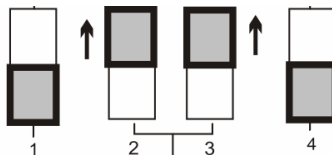

5.2 Connecting to a TV

5.2.1 NTSC: America, Taiwan, Panama, Philippines, Canada, Chile, Japan, Korea and Mexico

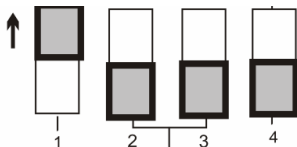

5.2.2 PAL: Countries/regions not listed above.

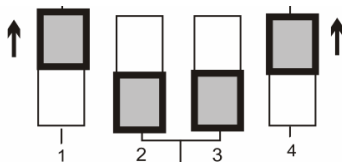



<Remark> VGA output is not supported once C-Video output has been enabled.

Chapter 6 Control Panel/Remote Control and Setting Menu

6.1 Functions of control panel and remote control

<Note> You are unable to use the [Menu] / [Rotate] / [Half Page] / [Source] / [Record] / [Capture] / [Delete] / [PBP] / [Slide Show] functions in C-Video mode.

<Remark> The below functions are listed alphabetically.

Name	Function	Operation
	Turn on and off the visual presenter.	Remote control / Control panel
	Move up, down, left or right to select the needed function.	Remote control / Control panel
AF	Automatically adjust focal length on an object.	Remote control / Camera Head
Auto Tune	Automatically adjust the image to have the best brightness and focusing performance.	Remote control / Control panel
BRT+/-	Manually adjust the brightness of the image.	Remote control
Capture	Capture the image to the SD card (priority) or internal memory.	Remote control / Control panel
Delete	Delete the image stored in the SD card (priority) or internal memory.	Remote control / Control panel
Enter	Enter/Activate functions.	Remote control / Control panel
Focus +/-	Manually adjust focal length on an object.	Remote control / Control panel
Freeze	Freeze the current image to temporarily stay on the screen. Press again to defreeze.	Remote control / Control panel
Half Page	Turn on/turn off the Half Page function. Pressing [Half Page] once will display the upper half of the live image, while pressing [Half Page] twice will show the lower half of the live image. Press [Half Page] again to exit this function.	Remote control / Control panel

Lamp	Turn on / off the lamp.	Remote control / Control panel
M Scope	Enter the microscope mode. Press again to return to the previous mode.	Remote control
Menu	Activate the setting menu function/exit menu.	Remote control / Control panel
Mode	Select general/slide/negative/microscope mode.	Remote control
PBP	PBP (Picture by picture): Compare live images with captured image files.	Remote control
Photo/ Text	Select photo, text or grayscale image mode. Refer to DC260 User Manual Chapter 7 Descriptions of major functions 7.2 I would like to make text clearer and photos more colorful	Remote control
Record	Record motion images. Press [Record] to record images to SD card (priority) or internal memory; press[Record]again to stop recording.	Remote control / Control panel
Rotate	Rotate the image by 0°/90°/180°/270°.	Remote control / Control panel
Slide Show	Show the photos or videos stored in the SD card (priority) or internal memory in slide mode.	Remote control
Source	Switch between different sources of signals: 1. Live images (default) 2. SD card (priority) or internal memory 3. Computer	Remote control / Control panel
Zoom +/-	Increase or decrease the image size.	Remote control / Control panel

6.2 Setting Menu

<Remark> Press [Menu] on the remote control or control panel to enter the setting menu; The bold underlined values in the following table are the defaults.

1 st Level Major Items	2 nd Level Minor Items	3 rd Level Adjustment values	Descriptions
Display	Brightness	0~Max	Use the left and right arrow keys to adjust the brightness.
	Mode	<u>Normal</u> /Slide/ Film/Microscope	Use the left and right arrow keys to select the image mode.
	Photo/Text	<u>Photo</u> /Text/Gray	Use the left and right arrow keys to select the image mode. Refer to DC260 User Manual Chapter 7 Descriptions of major functions 7.2 I would like to make text clearer and photos more colorful
	PBP	<u>Enter</u>	Press [Enter] to immediately activate photo comparison mode. Refer to DC260 User Manual Chapter 7 Descriptions of major functions 7.15 I would like to compare images
	Night Vision	On/ <u>Off</u>	Use the left and right arrow keys to select. The night vision mode suits with darker environment.
	Digital Zoom	On/ <u>Off</u>	Use the left and right arrow keys to turn digital zoom on/off.

Storage	Slide Show	<u>Enter</u>	Press [Enter] to play the photos or videos stored in the SD card (priority) or internal memory. Refer to DC260 User Manual Chapter 7 Descriptions of major functions 7.14 I would like to play the slides
	Slide Show Effect	<ol style="list-style-type: none"> 1. <u>Off</u> 2. Shutter 3. Right 4. Down 5. Side 6. Open 	Use the left and right arrow keys to select the image switch mode.
	Delay	<ol style="list-style-type: none"> 1. <u>1 Sec</u> 2. 3 Sec 3. 5 Sec 4. 10 Sec 5. Manual 	Use the left and right arrow keys to select the delay time. Select manual mode to switch images manually.
	Copy To SD	<u>Enter</u>	Press [Enter] to immediately copy the data in visual presenter to the SD card.
	Delete All	Yes/ <u>No</u>	Use the left and right arrow keys to select, and then press [Enter] to confirm the deletion of photos. Delete the image stored in the SD card (priority) or internal memory.
	Format	Yes/ <u>No</u>	Use the left and right arrow keys to select, and then press [Enter] to format the data stored in the SD card (priority) or internal memory.

	Image Quality	<ol style="list-style-type: none"> 1. High 2. <u>Medium</u> 3. Low 	Use the left and right arrow keys to select the image quality for the captured images and recorded videos.
Setting	Capture	<ol style="list-style-type: none"> 1. <u>Single</u> 2. Continuous 3. Disable 	Use the left and right arrow keys to select the video capture mode. (Single/Continuous/Disable)
	Capture Time	<ol style="list-style-type: none"> 1. <u>1 hr</u> 2. 2 hr 3. 4 hr 4. 8 hr 5. 24 hr 	Use the left and right arrow keys to set the capture time. <Remark> It only works when the capture mode is set to [continuous].
	Capture Interval	<ol style="list-style-type: none"> 1. <u>5 sec</u> 2. 10 sec 3. 30 sec 4. 1 min 5. 2 min 6. 5 min 	Use the left and right arrow keys to set the capture interval. <Remark> It only works when the capture mode is set to [continuous]
	USB Transfer	<ol style="list-style-type: none"> 1. <u>Camera</u> 2. Storage device 	<p>Use the left and right arrow keys to select the USB transfer mode.</p> <p>1.Camera: connecting the DC260 to view live image; 2.Storage device: connecting to the SD card (priority) or internal memory.</p> <p>Refer to DC260 User Manual Chapter 7 Descriptions of major functions 7.20 Computer-related functions</p>

	AE	<u>On/Off</u>	Regardless of outside environment, the machine will adjust the brightness to the optimal condition. Use the left and right arrow keys to select.
	AWB	<u>Enter</u>	Regardless of outside light or color, the machine will adjust the color to the optimal condition. Press [Enter] to activate.
	Digital Zoom	On/ <u>Off</u>	Use the left and right arrow keys to turn digital zoom on/off.
	Noise Reduction	On/ <u>Off</u>	Use the left and right arrow keys to turn on/off the noise reduction function. Refer to DC260 User Manual Chapter 7 Descriptions of major functions 7.17 I would like to reduce the image noise
	Volume	0~Max	Use the left and right arrow keys to adjust the volume.

Advance	Language	<ol style="list-style-type: none"> 1. <u>English</u> 2. 繁体中文 3. Deutsch 4. Français 5. Italiano 6. Español 7. Русский 8. Nederlands 9. Suomi 10. Polski 	<p><u>English</u> Traditional Chinese German French Italian Spanish Russian Dutch Finnish Polish</p> <p>Use the left and right arrow keys in the language option to select the preferred language.</p>
	Output Mode	<ol style="list-style-type: none"> 1. XGA 2. SXGA 3. UXGA 4. 720P 5. 1080P 	<p>Using UXGA - set the DIP switch for XGA, select UXGA for OSD</p> <p>Using 1080P - set the DIP switch as 720P, select 1080p for OSD</p> <p>Based on different DIP switch settings, different output modes are provided. Refer to Chapter 5 DIP “Switch Settings” in the DC260 user manual.</p>
	Lock Down	On/ <u>Off</u>	<p>Use the left and right arrow keys to turn the lock down function on and off. You can set the password when [On] is selected. Refer to DC260 User Manual Chapter 7 Descriptions of major functions 7.18 I would like to set / change the password</p>

	Auto Erase	On/ <u>Off</u>	<p>Use the left and right arrow keys to turn the auto erase function on and off. When [On] is selected, the saved images will automatically be deleted when the system is turned off.</p> <p>Refer to DC260 User Manual Chapter 7 Descriptions of major functions 7.11 I would like to automatically delete the captured images whenever it is turned off</p>
	Preset Load	Yes/ <u>No</u>	<p>Read the value of the current image mode.</p> <p>Use the left and right arrow keys to select, and then press [Enter] to confirm.</p>
	Preset Save	Yes/ <u>No</u>	<p>Save the value of the current image mode.</p> <p>Use the left and right arrow keys to select, and then press [Enter] to confirm.</p>
	Factory Reset	Yes/ <u>No</u>	<p>Use the left and right arrow keys to select, and then immediately press [Enter] to activate the factory reset.</p> <p>Refer to DC260 User Manual Chapter 7 Descriptions of major functions 7.16 I would like to resume the factory default setting</p>

Chapter 7 Descriptions of major functions

7.1 I would like to switch image sources

Live image is the default of image source. Press [Source] on the **remote control** or **control panel** to change:

1. Live images (default)
2. SD card (priority) or internal memory
3. Computer.

7.2 I would like to make text clearer and photos more colorful

Photo is the default. You can change setting via the **remote control** or **control panel**.

Remote control:

1. You can rotate between **photo**, **text**, and **gray**:
 - [Photo] (default): for viewing photos or text with photos and will make the photos more colorful.
 - [Text]: for viewing text files and will make the text clearer.
 - [Gray]: for viewing black and white photos and will make the grayscale differentiation more distinct.

Control panel:

1. Press [MENU] to enter the setting menu.
2. Press [▶] or [◀] to select [Display].
3. Press [▼] to select [Photo/Text].
4. Press [▶] or [◀] to select [Photo/Text/Gray] (Refer to the description above).
5. Press [MENU] to exit.

7.3 I would like to zoom in /out of images

1. Press [Zoom +] on the **remote control** or **control panel** to zoom in.
2. Press [Zoom -] on the **remote control** or **control panel** to zoom out.

7.4 I would like to use the auto focus

1. Press [AF] on the **remote control**.
2. Press the **AF button** on the camera head of main unit.

7.5 I would like to adjust the brightness

Remote control:

1. Press [BRT +] to make it brighter.
2. Press [BRT -] to make it darker.

Control panel:

1. Press [MENU] to enter the setting menu.
2. Press [▶] or [◀] to select [Display].
3. Press [▼] to select [Brightness].
4. Press [▶] or [◀] to adjust the value.

7.6 I would like to turn on/ off the lamp

1. The default of lamp is turn on. Press [Lamp] on the **remote control** or **control panel** to turn off.

7.7 I would like to automatically adjust the image to have best brightness and focusing performance

1. Press [Auto Tune] on the **remote control** or **control panel**.

7.8 I would like to capture images

7.8.1 Setting the quality of captured images

1. Press [Menu] on the **remote control** or **control panel** to enter the setting menu.
2. Press [▶] or [◀] to the [Storage] menu.
3. Press [▼] to find [Image Quality].
4. Press [▶] or [◀] to select among [High/Medium/Low].
5. Press [Menu] to exit.

7.8.2 Setting continuous capture

1. Press [Menu] on the **remote control** or **control panel** to enter the setting menu.
2. Press [▶] or [◀] to the [Setting] menu.
3. Press [▼] to find [Capture].
4. Press [▶] or [◀] to select [continuous].
5. Press [▼] to find [Capture Time]; Press [▶] or [◀] to select time settings.
6. Press [▼] to find [Capture Interval]; Press [▶] or [◀] to select time settings.
7. Press [Menu] to exit.

7.8.3 Capturing and saving images

1. Press [Capture] on the **remote control** or **control panel**.

7.9 I would like to view captured images

1. Press [Source] on the **remote control** or **control panel** to display thumbnails of all captured images.
2. Press [▲] or [▼] or [▶] or [◀] to select the thumbnail you want you view.
3. Press [Enter] for the full-screen display of the image.
4. Press [▶] or [◀] to turn to the previous/next image.
5. Press [Source] to exit.

7.10 I would like to delete captured images

1. Press [Source] on the **remote control** or **control panel**.
2. Press [▲] or [▼] or [▶] or [◀] to select the thumbnail you want you delete.
3. Pressing [Del] will open a [Delete File] window.
4. Press [▶] or [◀] to select [Yes] (The default value is No).
5. Press [Enter] to delete the selected photo.
6. Press [Source] to exit.

7.11 I would like to automatically delete the captured images whenever it is turned off (Auto Erase)

1. Press [Menu] on the **remote control** or **control panel** to enter the setting menu.
2. Press [▶] or [◀] to access the [Advance] menu.
3. Press [▲] or [▼] to [Auto Erase].
4. Press [▶] to select [On].
5. Press [▶] or [◀] to select [OK].
6. Press [Menu] to exit.
7. It will automatically delete all captured photos when it is turned off.

7.12 I would like to record and play videos

7.12.1 Setting the image quality

1. Press [Menu] on the **remote control** or **control panel** to enter the setting menu.
2. Press [▶] or [◀] to the [Storage] menu.
3. Press [▼] to find [Image Quality].
4. Press [▶] or [◀] to select among [High/Medium/Low].
5. Press [Menu] to exit.

7.12.2 Recording videos

1. Press [Record] on the **remote control** or **control panel** to start recording videos.
2. Simultaneously record sounds with the built-in microphone of the control panel or the microphone connected to the MIC port.
3. Press [Record] again to stop recording.

[Note] The MIC port cannot be connected to an amplifier before connecting to the microphone.

7.12.3 Playing videos

1. Press [Source] on the **remote control** or **control panel** to display thumbnails of all video recorded.
2. Press [▲] or [▼] or [▶] or [◀] to select the thumbnail you want you view.
3. Press [Enter] for full-screen play

4. Press [▶] or [◀] to turn to the previous/next video.
5. Press [Source] to exit.

[Note] Only the MOV files recorded can be played and live sound output is not available; additional amplifier can be connected to the PHONE port.

7.13 I would like to switch the view between the upper and lower half of the image (Half Page)

1. Press [Half Page] on the **remote control** or **control panel** and the upper half of the live image will be displayed.
 2. When you press [Half Page] again, the lower half of the live image will be displayed.
 3. Press [Half Page] again to exit this function and return to the live image.
- <Notes> This function is not available under Microscope Mode. The Zoom in / out function is not available when this function is activated.**

7.14 I would like to play the slides (Slide Show)

7.14.1 Setting the slide show effect

1. Press [Menu] on the **remote control** or **control panel** to enter the setting menu.
2. Press [▶] or [◀] to access the [Storage] menu.
3. Press [▼] to find the [Slide Show Effect].
4. Press [▶] or [◀] to select image switch mode between [Off / Shutter / Right / Down / Side / Open].
5. Press [Menu] to exit.

7.14.2 Setting delay time

1. Press [Menu] on the **remote control** or **control panel** to enter the setting menu.
2. Press [▶] or [◀] to access the [Storage] menu.
3. Press [▼] to find the [Delay].
4. Press [▶] or [◀] to select image switch mode between [1 Sec / 3 Sec / 5 Sec / 10 Sec / Manual].
5. Press [Menu] to exit.

7.14.3 Activating/Stopping the slide show

<Notes>Images over 8 MB, cannot be played. Whilst playing, the [Rotate] function can be activated to rotate the images.

Remote control:

1. Press [Slide Show] to start playing.
2. Press [Slide Show] again to stop playing.

Control panel:

1. Press [Menu] to enter the setting menu.
2. Press [▶] or [◀] to access the [Storage] menu.
3. Press [▼] to find [Slide Show]
4. Press [Enter] to play.
5. To stop playing, repeat steps 1 to 4.

7.15 I would like to compare images (Compare live images with captured images) (PBP, Picture by Picture)

This function will compare and contrast a live image with a captured image.

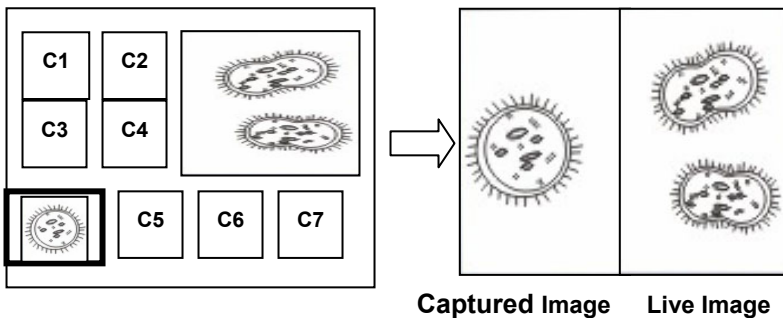

Remote control:

1. Press [PBP] to enter the PBP (Picture by Picture) photo selection screen.
2. Press [▲] or [▼] or [▶] or [◀] to select the files to be compared.
3. Press [Enter] to activate the image comparison.
4. Press [▶] or [◀] to move the images (captured images only) leftward/rightward.
5. Press [PBP] to exit.

Control panel:

1. Press [Menu] to enter the setting menu.
2. Press [▶] or [◀] to access the [Display] menu.
3. Press [▼] to find [PBP]
4. Press [Enter] to enter the PBP (Picture by Picture) photo selection screen.
5. Press [▲] or [▼] or [▶] or [◀] to select the files to be compared.
6. Press [Enter] to activate the image comparison.
7. Press [▶] or [◀] to move the images (captured images only) leftward/rightward.
8. Press [Menu] again to return to image thumbnails.
9. Press [Source] to exit.

7.16 I would like to resume the factory default setting (Factory Reset)

1. Press [Menu] on the **remote control** or **control panel** to enter the setting menu
2. Press [▶] or [◀] to access the [Advance] menu.
3. Press [▼] to select [Factory Reset].
4. Press [▶] or [◀] to select [Yes].
5. Press [Enter] to activate.

7.17 I would like to reduce the image noise (Noise Reduction)

This function enables visual presenter to automatically clear image noise. The noise is especially obvious when Visual presenter is connected to a DLP projector. You can use this function to improve the image quality.

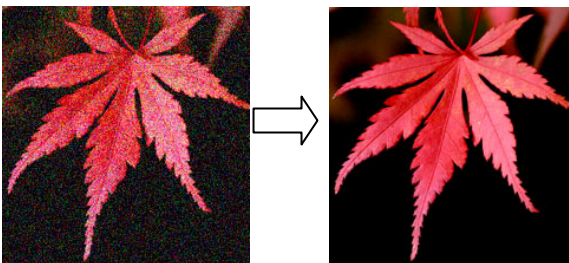

1. Press [Menu] on the **remote control** or **control panel** to enter the setting menu.
2. Press [▶] or [◀] to the [Setting].
3. Press [▼] to find [Noise Reduction].
4. Press [▶] or [◀] to select [On].

7.18 I would like to set / change the password (Lock Down)

7.18.1 Setting the password

1. Press [Menu] on the **control panel** to enter the setting menu.
2. Press [▶] or [◀] to the [Advance] menu.
3. Press [▼] to [Lock Down].
4. Press [▶] or [◀] to select [On].
5. The screen will be displayed, as shown below.



6. Key in the password

Press the keys on the **control panel**. All keys can be used as part of the password except the [Power] and [Enter] keys. **The maximum number of characters is 2.** For example, you can press [Source] + [Menu] as the password.

<Remark>The screen will show * while you enter the password. Ensure that you remember the order in which the keys are entered.

7. After completing the password, press [Enter].
8. The confirmation screen will be displayed, as shown below. Enter the password again.

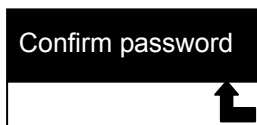

9. After you enter the password, press [Enter].
If the password is entered correctly, setup is completed. If the password is incorrect, an error message is displayed and please follows the screen instructions.

7.18.2 Changing the password

1. Press [Menu] on the **control panel** to enter the setting menu.
2. Press [▶] or [◀] to the [Advance] menu.
3. Press [▼] to [Lock Down]
4. Press [▶] or [◀] to select [Off] and deactivate the password setting function.
5. Press [▶] or [◀] to select [On] and reactivate the password setting function. Refer to Steps 5-8 in [DC260 User Manual Chapter 7 Descriptions of major functions 7.18 I would like to set / change the password](#) for operational steps.

7.19 Using a SD card

7.19.1 Deactivate the write protect function (SD Lock)

If the write protect function of the SD card is activated, you will not be able to use the **Capture** function, although you can still read the files in it. Adjust the Lock of the SD card to deactivate the write protect function.

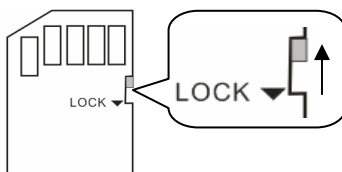

7.19.2 Inserting a SD card

7.19.2.1 The screen will display [Copy to SD card] and ask if you would like to copy the files saved in the DC260 to a SD card.

- Press [▶] or [◀] on the **control panel** to select.



7.19.2.2 The screen will display as follow, once you insert an unformatted SD card.

- Press [▶] or [◀] on the **control panel** to select.

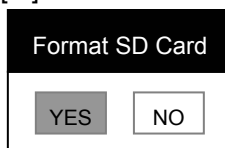

<Note> The data previously saved on the SD card will be erased when it is formatting.

7.19.3 Ejecting a SD card

<Note> Turn the power off before ejecting the SD card to avoid damaging the SD card.

7.20 Computer-related functions

Ensure that the USB cable is connected and the drivers are installed before using the computer-related functions. Refer to [DC260 User Manual Chapter 4 Installation and Connections 4.3 Connecting Devices and 4.6 Installing Driver and Application queue.](#)

7.20.1 I would like to insert a photo in *MS-Paint*

1. Click **File> From Scanner or Camera** in *MS-Paint* shown as the bottom left figure.

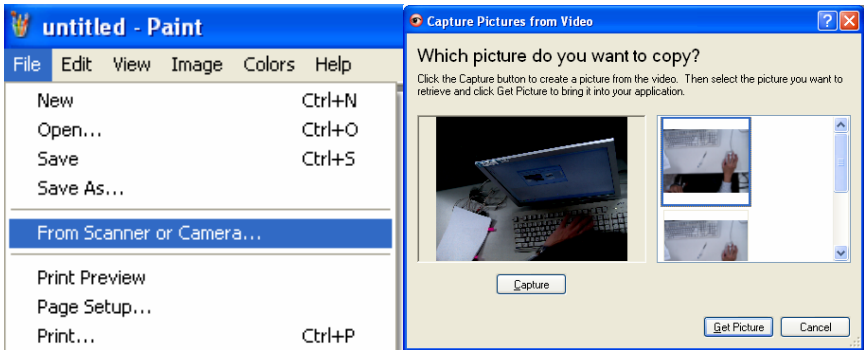

2. Click [Get Picture] will capture the photos of live images and insert the files in use shown as top right figure.

7.20.2 I would like to insert a photo in *MS-Word*

1. Click **Insert > Image > From Scanner or Camera** in **MS-Word**.

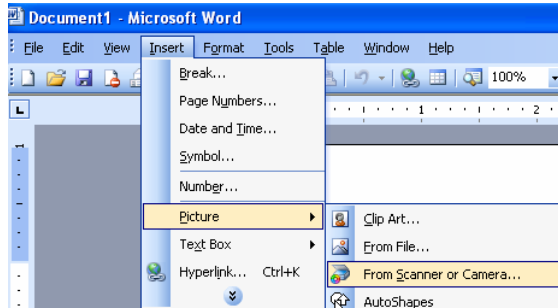

2. Select [Visual Presenter V2] and click [Custom Insert].



3. Click [Get Picture]. It will capture the photo of live image.

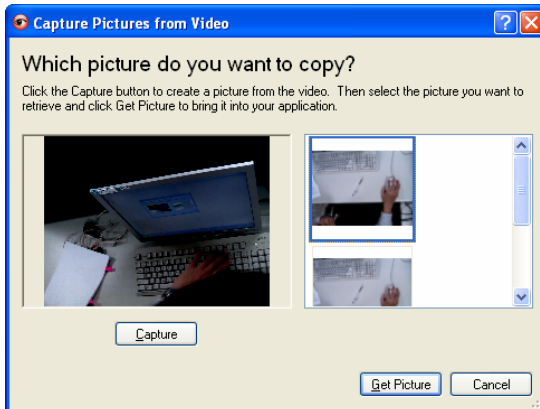

7.20.3 I would like to change the setting of DC260 then capture a photo in *MS-Word*

1. Click **Insert > Image > From Scanner or Camera** in *MS-Word*.

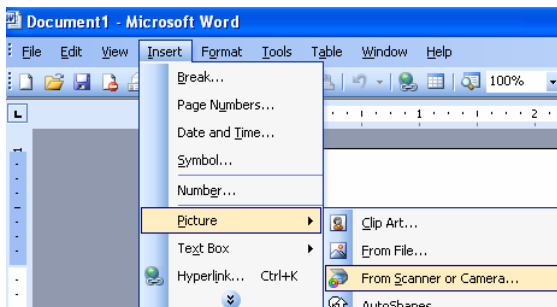

2. Select [Visual Presenter V2 TWAIN] and click [Custom Insert].



3. A window showing a live image (see below) will be displayed.

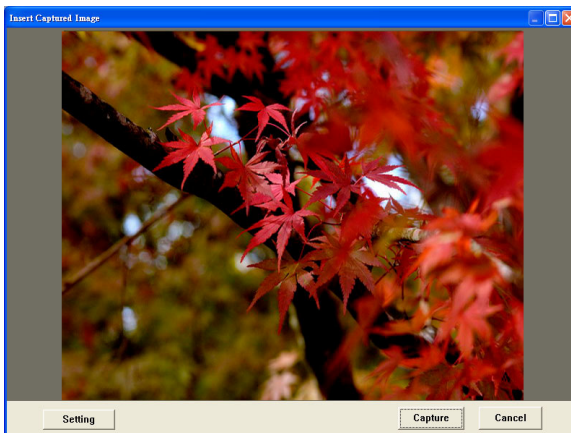

4. Press [Setting] to control the DC260 via the **Camera Settings** interface. The operating procedure is the same with the **remote control** and **control panel** of the DC260. Refer to [DC260 User Manual Chapter 6 Control Panel / Remote Control and Setting Menu](#).
5. Press [Setting] to capture images in **MS-Word**.
6. Press [Cancel] to exit.

7.20.4 I would like to set the DC260 as a **webcam** for **Skype**

The DC260 can be used as a **webcam** for **teleconferencing** software such as **Skype** and **MSN**. The following instructions use Skype as an example.

1. Open **Skype** and enter **Tools > Options...**
2. Select [Video Settings] > [webcam] > [Visual Presenter V2] and check Start my video automatically when I am in a call, as shown below.

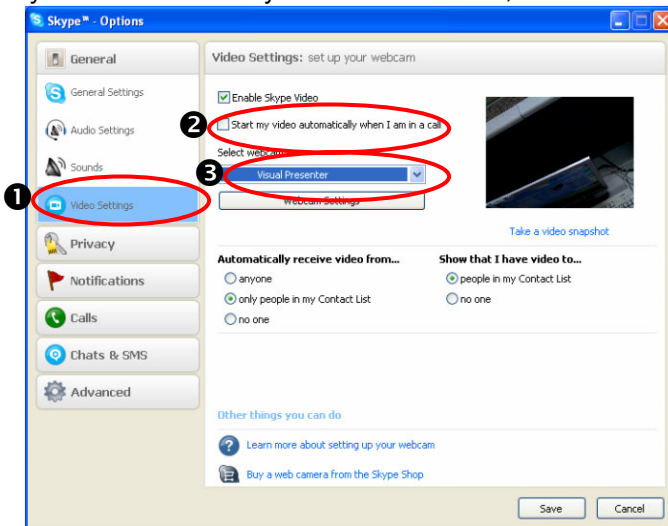

3. Start calling your contact. When both sides are connected, **Skype** will display the video screen.

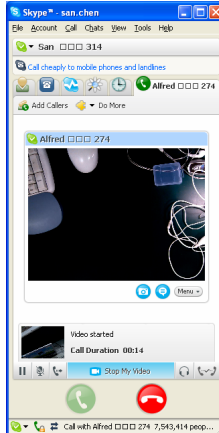

7.20.5 I would like to set the DC260 as a PC Camera

1. Press [Menu] on the **control panel** to enter the setting menu.
2. Press [▶] or [◀] to the [Setting] menu.
3. Press [▼] to find [USB Transfer].
4. Press [▶] or [◀] to select [Camera].
5. A window will be displayed, showing the [Visual Presenter V2], as shown below

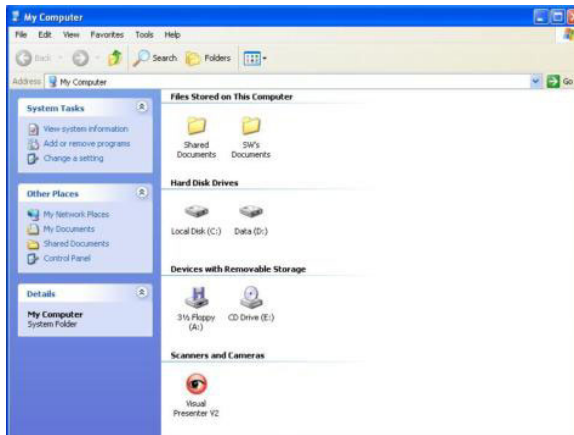

6. Click the [Visual Presenter V2].

7.20.6 I would like to set the DC260 as a *Removable Disc*

1. Press [Menu] on the **control panel** to enter the setting menu.
2. Press [▶] or [◀] to the [Setting] menu.
3. Press [▼] to find [USB Transfer].
4. Press [▶] or [◀] to select [Storage device].
5. Press [Menu] to exit.
6. A **Removable Disc** will be displayed.

<Remark> The **Removable Disc** will select SD card if a SD card has been inserted, but if a SD card has not been inserted, the **Removable Disc** is internal memory.

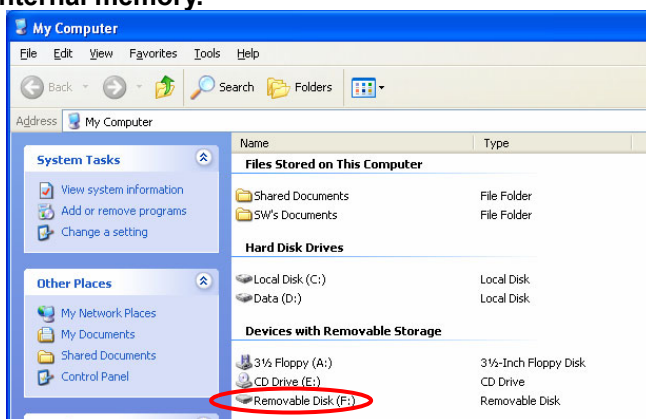

<Note> Doing this will disable the **Capture** function. Suggest you return it to [Camera] mode after using this function. Please follow the steps below.

1. Press [Menu] on the **control panel** to enter the setting menu.
2. Press [▶] or [◀] to the [Setting] menu.
3. Press [▼] to find [USB Transfer].
4. Press [▶] or [◀] to select [Camera].
5. Press [Menu] to exit.

7.20.7 I would like to connect Interactive Whiteboard

1. System diagram

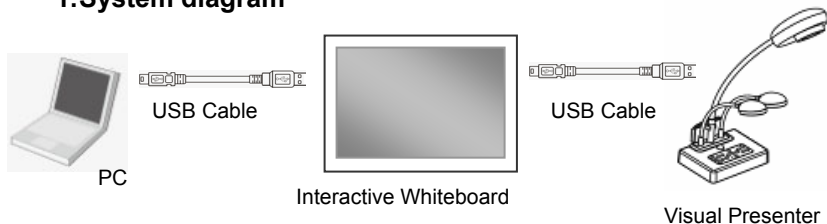

2. Using StarBoard

2.1 Install **LuLulizer** and execute “LuLulizer.exe”

<Note> Please download LuLulizer from the website (www.lumens.com.tw/goto.htm)

2.2 Press [StarBoard] / [LULU]



2.3 Display the live image.



2.4 Press [StarBoard] / [Mode] / [TWAIN]

Please refer to the operations of [7.20.2 I would like to insert a photo in MS-Word](#) and [7.20.3 I would like to change the setting of DC260 then capture a photo in MS-Word](#)

3. Using SmartBoard

3.1 Press [Insert] / [Picture From Scanner]

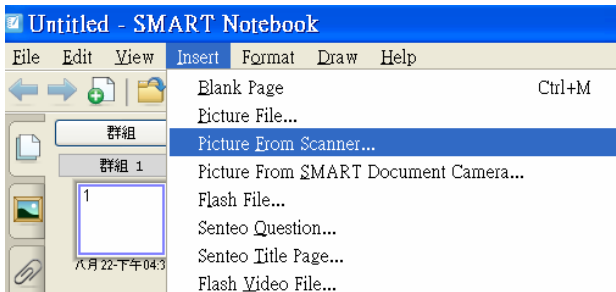

3.2 Please refer to the operations of [7.20.2 I would like to insert a photo in MS-Word](#) and [7.20.3 I would like to change the setting of DC260 then capture a photo in MS-Word](#)

Chapter 8 Connecting to Microscope

1. Mount the **microscope adaptor** onto the microscope.
2. The lens of DC260 connects with the **microscope adaptor**.

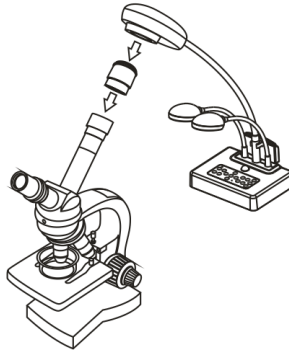

3. Select the [Microscope] Mode

3.1. Press [M Scope] on the **remote control** (suggestion).

3.2. Control panel

3.2.1. Press [MENU] to enter the setting menu.

3.2.2. Press [▶] or [◀] to select [Display].

3.2.3. Press [▼] to select [Mode].

3.2.4. Press [▶] or [◀] to select [Microscope].

4. If the image is not clear.

4.1. Please adjust the focus of microscope.

4.2. Press the **AF** button on the camera head of main unit to activate the auto focus.

5. Digital Zoom

5.1. Press [MENU] to enter the setting menu.

5.2. Press [▶] or [◀] to select [Display].

5.3. Press [▼] to select [Digital Zoom].

5.4. Press [▶] or [◀] to select [On].

5.5. Press [Zoom +]/[Zoom -] on the remote control and control panel

<Note> In microscope mode all functions are available except for the [Zoom +] / [Zoom -] / [Half Page] functions on the remote control and control panel. Please reset to normal mode after using the microscope, otherwise, you are unable to use zoom in/out function.

1. Press [MENU] on the **control panel** to enter the setting menu.

2. Press [▶] or [◀] to select [Display].
3. Press [▼] to select [Mode].
4. Press [▶] or [◀] to select [Normal].

Chapter 9 Troubleshooting

This chapter describes problems you may encounter while using DC260. If you have questions, please refer to related chapters and follow all the suggested solutions. If the problem still occurred, please contact our distributors or service center.

No.	Issues	Solutions
1	Boot without power	Make sure you have plugged in the power cord.
2	No image output from the DC260	<ol style="list-style-type: none">1. Check the power.2. Check the connection, Refer to DC260 User Manual Chapter 4 Installation and Connections 4.3 Connecting Devices3. Check the [Source], refer to DC260 User Manual Chapter 7 Descriptions of major functions 7.1 I would like to switch image sources4. Check the settings for the source of the projector. For the appropriate input selection of the projector, refer to the projectors user manual5. Check if DIP Switch is properly set. Refer to DC260 User Manual Chapter 5 DIP Switch Settings for related settings.
3	Unable to focus	Probably the document is too close. Press [zoom -] on the remote control or control panel . Or pull away the distance between document and lens, then press [AF].
4	The image is incomplete	Check the Auto Image setting of your projector . Please refer to the user manual of the projector .
5	Forget the password for turning on	Please contact your distributor or the service center.
6	Visual Presenter V2, queue or other application cannot be executed simultaneously.	Visual Presenter V2, queue and other applications cannot be executed simultaneously. Only one application can be executed at a time. Please close the currently running applications and then execute the application to be used.

LumensTM

<http://www.lumens.com.tw>

NOV 7 , 2008

Verson:02

P/N: 5080092-51