



Firmware Version: 1.xx

EN

USER INSTRUCTIONS AND SAFETY

Congratulations on your purchase of an N-Com product.

N-Com **B1** was made using the most advanced technologies and the best materials. Long-running tests and thorough system development have allowed the highest audio quality to be achieved.

For additional information about **B1**, and to download high-definition instructions as well as the latest *Firmware* version, visit the website www.n-com.it

REFERENCE STANDARDS

The products of the N-Com line are in compliance with standards as per the table below:

B1	The Bluetooth system complies with the main safety requirements and other applicable provisions of Directive 99/5/CE, Directive 2002/95/CE, Directive 2011/65/CE, Directive 2002/96/CE
-----------	--

Battery charger	Directive 2006/95, 2004/108, 2002/95/CE, 2002/96/CE, 2009/125/CE
------------------------	--

Battery	Directive 2006/66
----------------	-------------------

The Declarations of Compliance can be downloaded from the website www.n-com.it (Download section).

FccID: Y6MNCOM5	 Bluetooth [®]	 N21550	
------------------------	---	--	--

Bluetooth is a registered trademark property of Bluetooth SIG, Inc.

Contents

1. WARNINGS AND SAFETY	4
1.1.Road safety.....	4
1.2.Switching on the system in safe environments	4
1.3.Interferences	4
1.4.Appropriate use	4
1.5.Qualified personnel	5
1.6.Accessories and batteries	5
1.7.Disposal	6
2. CONTENT OF THE PACKAGING	6
3. INSTALLATION	7
3.1.Installing the microphone.....	9
3.2.Connecting the battery	10
3.3.Installing the system on the helmet	11
4. REMOVING THE SYSTEM	14
5. SYSTEM CHARACTERISTICS	14
5.1.Basic functions	15
5.2.N-Com Wizard.....	15
6. PAIRING UP BLUETOOTH DEVICES	15
6.1.Affiliation reset function	16
7. MOBILE PHONE FUNCTIONS	16
8. GPS SATELLITE NAVIGATOR FUNCTIONS	16
9. BLUETOOTH A2DP MUSIC PLAYER	17
10. AUDIO DEVICES WITH CABLE CONNECTION	17
11. RIDER-PASSENGER INTERCOM MODE	18
11.1.Intercom affiliation	18
11.2.Intercom function.....	18
12. BATTERY	19
12.1.Battery discharged signal.....	19
12.2.Recharging the system.....	19
13. SUMMARY TABLE OF CONTROLS	20
14. LIMITED WARRANTY	21
14.1.Warranty coverage	21
14.2.Exclusions and limitations of the coverage.....	21
14.3.Validity of this limited warranty	21
14.4.Procedure for the forwarding of claims	22
14.5.Product identification	22
15. WARRANTY REGISTRATION FORM	23

1. WARNINGS AND SAFETY

Read this User Manual carefully, as well as the User Manuals for other N-Com kits that you will be using with the N-Com **B1**. Read the simple rules listed below. Failure to comply with these rules may lead to dangerous situations.

Caution: The product cannot be used in official or non-official competitions, motordromes, circuits, racing tracks and the like.

Caution: Installation of the N-Com **B1** system results in a weight increase of approximately 110g, which is added to the weight of the helmet and of the other accessories.

Warning: The electronic components of the N-Com system mounted inside the helmet are not waterproof. Consequently, make sure the inside of the helmet, including the comfort padding, does not get wet in order to avoid damage to the system. If it does, remove the N-Com system and the helmet comfort padding and let it air dry. Disconnect the battery connector and let it dry as well.

1.1. Road safety

Always obey all Traffic Regulations in force. While riding the motorcycle, your hands should always be engaged in actually riding the vehicle. Any operation to the N-Com system must be carried out with the vehicle stopped. Specifically:

- Set your cell phone on automatic answer (see the cell phone instructions to do this).
- If your cell phone is not equipped with this function, first stop your vehicle in a safe area, in compliance with Traffic Regulations and then answer the call.
- Do not make any calls while riding. Stop your vehicle in a safe place in compliance with Traffic Regulations, and then make the call.
- Adjust the volume so that it does not cause a disturbance or distraction while riding and at the same time allows you to distinctively hear background noises.
- Do not operate your cell phone or other devices connected to N-Com while riding your motorcycle.
- In all cases, obey the Traffic Regulations and remember that riding the motorcycle has absolute priority over any other maneuver.

1.2. Switching on the system in safe environments

- When using the N-Com system, comply with all limitations and instructions related to the use of cell phones.
- Do not turn on your cell phone or the N-Com system whenever their use is forbidden or when the devices can cause interference or dangerous situations.
- Turn off while refueling. Do not use the N-Com system in filling stations. Do not use the device near combustible materials or chemical products.
- Turn off in proximity to explosive materials.

1.3. Interferences

All phones and devices with wireless signal transmission are subject to interferences that may affect the performance of the device connected to them. These interferences are not ascribable to a defect of the N-Com system.

1.4. Appropriate use

Use the device only in the normal position, as described in the product documentation. Do not attempt to disassemble, tamper with or modify any part of the N-Com system.

Caution: Adjust the volume of the N-Com system (where provided) and of the audio sources connected to it before you use the system on the road.

Caution: Adjusting the volume to very high levels may cause damage to your hearing.

Caution: Adjust the volume of the N-Com system (where provided) and of the audio sources connected to it so as to avoid audio reproduction at high volumes. Constant exposure to high audio volumes may damage your hearing.

Caution: An incorrect installation of the system in the helmet may alter the aerodynamic and safety characteristics of the helmet itself, thus creating dangerous conditions. Install the N-Com system according to the instructions provided in the product documentation. In case of doubt, please contact your local N-Com dealer.

Warning: Listening to other equipment should not interfere with driving the vehicle, which must be the top priority at all times. Carry out all operations on the electronic equipment and on the N-Com system with the vehicle stopped, in compliance with Traffic Regulations.

1.5. Qualified personnel

- Only qualified personnel can carry out technical assistance on this product. In case of any malfunction, always turn to your local dealer.
- The helmet is a safety device. Tampering with it and/or with the electronic system inside the helmet, in addition to invalidating the product warranty, can also lead to dangerous situations.

1.6. Accessories and batteries

- Only use the type of batteries, battery chargers and accessories approved by Nolan for the specific model.
- The use of a battery type different from the recommended one may lead to dangerous situations and invalidate the warranty.
- Contact your local dealer to see about the availability of approved accessories.
- When disconnecting the power supply cable of any accessory or of the battery charger, always grab and pull the plug not the cable.
- Do not use batteries for purposes other than the prescribed ones.
- Never use batteries or battery chargers that turn out to be damaged.
- Do not short-circuit the battery.
- Keep the battery at a temperature between **0° / +45°C (charging); -20° / +60 °C (in use)**.
- Danger of fire or explosion: do not throw the batteries into a fire nor expose them to high temperatures!
- Do not throw out batteries together with household refuse. The batteries should be disposed of in compliance with local regulations
- Do not wear the helmet while the battery is recharging.
- The helmet should never be left within the reach of unsupervised children in order to prevent damage to their health caused by access to the batteries.

Battery	Lithium Ion593847	3,7V – 800mAh
Batterycharger	AK00G-0500040VU	100/240v – 50/60 Hz 5V – 0,4 A
	S-TR-038	100-240V - 60/50Hz 0.1A

1.7. Disposal











Refer to this user manual and to manuals related to other parts of the N-Com system in order to disassemble the system from the helmet. Once the system has been disassembled, dispose of it according to the following instructions:



- The presence of a crossed-out wheeled bin indicates that in the European Union the product is subject to separate collection at the end of its useful life (European Directive 2002/96/EC).
- Do not dispose of these products together with undifferentiated urban waste.
- The proper disposal of obsolete equipment contributes to preventing possible negative consequences on people's health and on the environment.
- For more detailed information on the disposal of obsolete equipment, contact your municipality, a waste disposal service or the store where the product was purchased.

2. CONTENT OF THE PACKAGING

The N-Com **B1** package contains:

 <p>e-box B1</p>	 <p>Electronic plate</p>	 <p>PC connection cable</p>	
 <p>Microphone</p>	 <p>Rechargeable battery</p>	 <p>Battery charger</p>	
 <p>Battery holder</p>	 <p>Key and screw</p>	 <p>Clamp Microphone- Stop</p>	 <p>Adhesive Velcro pads</p>

3. INSTALLATION

You can download the installation video from www.n-com.it N-Com / Download section.

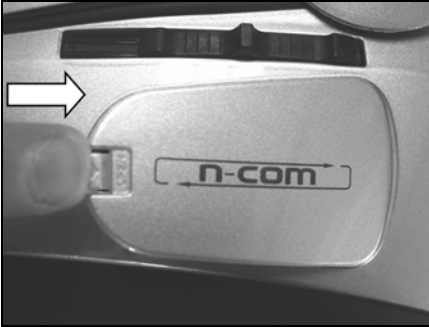

Fig. 1



Fig. 2



Fig. 3

- Remove the “N-Com” protection plate located on the helmet shell (Fig. 1) and open the helmet chin guard (flip up helmets).
- Remove the right and left cheek pads from the helmet (see specific instructions provided in the user manual of the helmet).
- Remove the Noise Reducers from the two cheek pads, and tear off the pre-cut plastic (if equipped).

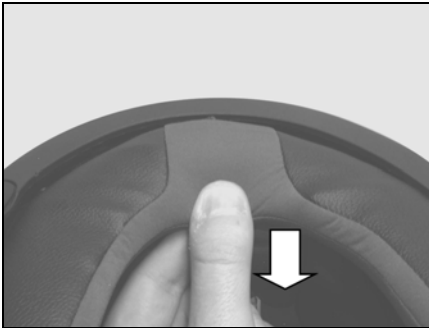

Fig. 4

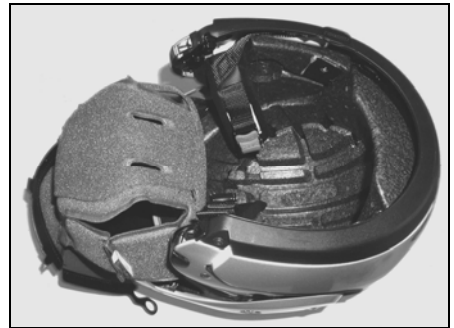

Fig. 5



Fig. 6

- Remove the back of the comfort padding by pulling on the neck roll until it separates from the shell (Fig. 4).
- Temporarily put the padding on the outside of the helmet (Fig. 5).
- Remove the N-Com cover from the helmet border gasket. Push from the inside of the helmet to facilitate the removal (Fig. 6).



Fig. 7

ONLY FOR FULL-FACE HELMETS

- Remove the chin guard by pulling on the special red tab.



Fig. 8

- Remove the right and left polystyrene cheek pads by gently pulling them out of the helmet. The helmet shell can be opened slightly to facilitate the removal of the cheek pad .

Caution: In case the polystyrene cheek pad is damaged during this operation, turn to your local dealer for its replacement.

3.1. Installing the microphone

JET HELMETS OR FLIP-UP HELMETS

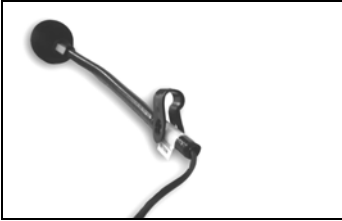

Fig. 9

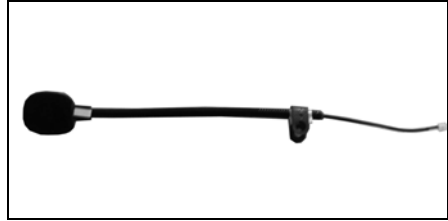

Fig. 10

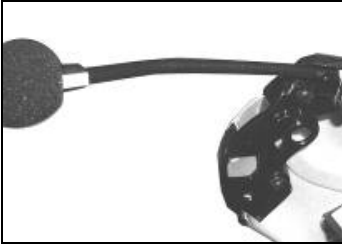

Fig. 11

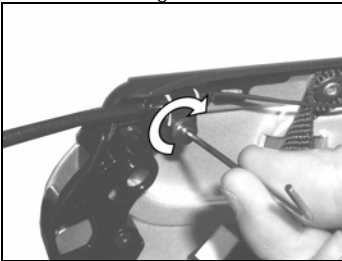

Fig. 12

- Prepare the microphone by inserting the microphone clamp, being careful to position it properly (Fig. 9)

Note: the flat part of the clamp must be facing upward when the microphone is positioned as shown in figure 11.

- Position the microphone in its support as shown in figure 10, being careful that the fluorescent clamp is facing toward the inside of the helmet.
- Insert screw in the microphone clamp; use the key to screw in the microphone securing screw to the shell frame.

FULL-FACE HELMETS



Fig. 13

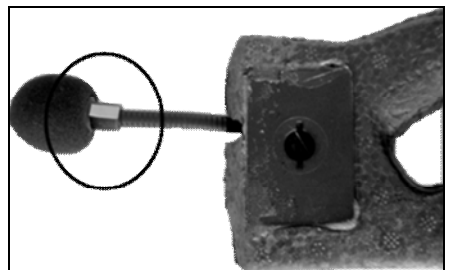

Fig. 14

- Take the polystyrene cheek pad (left-hand side) and position the microphone in its housing, as shown in fig. 13, making sure that the fluorescent band stays facing the inside of the helmet. (Fig. 14)

3.2. Connecting the battery

Only for Jet helmets or flip-up helmets:

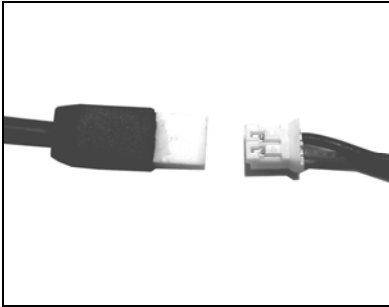

Fig. 15

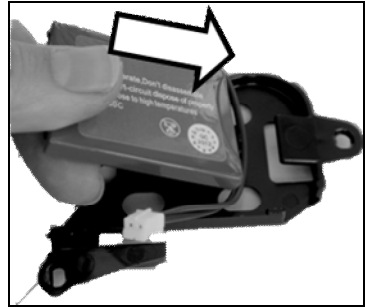

Fig. 16

- Hook up the battery cable (Red+Black) to the connector located on the wiring system (Fig. 15).
- Insert the battery in its holder, first positioning the side equipped with the cables outlet, keeping the cables underneath the plastic tab (Fig. 16).



Fig. 17



Fig. 18

- Insert the connectors set in the cable-stop guide located on the side of the battery-holder (Fig. 17 and 18).

Only for full face helmets:



Fig. 19

- Position the battery in the right polystyrene cheek pad housing (Fig. 19).

3.3. Installing the system on the helmet



Fig. 20

- Position the system inside the helmet as shown in figure 20, next to the N-Com housing in the shell.

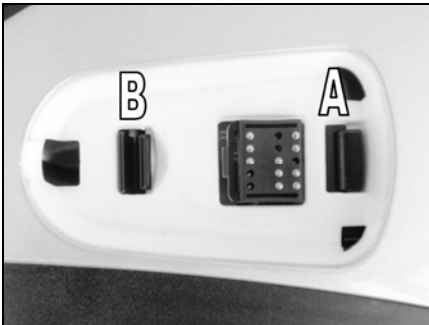

Fig. 21

- Looking at the helmet from the outside, slide the rear positioning tab into groove A as shown in the figure;
- Press in the area marked PUSH from inside the helmet until the fastening clasp B clicks (Fig. 21).



Fig. 22

- Pull out the connectors area from the helmet gasket: the gasket will have to be slightly deformed to facilitate the insertion.



Fig. 23

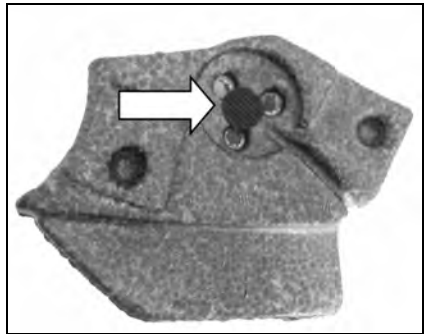

Fig. 24

- Insert the microphone connector in the micro USB electronic plate.
- Before you place the speaker in its housing, apply the Velcro pad to the polystyrene cheek pad (Fig. 24).



Fig. 25

- Position the loudspeaker in the special housing obtained in the polystyrene cheek pad (Fig. 25).



Fig. 26

- Replace the polystyrene cheek pad (left side), positioning the cable in the groove that you see in the cheek pad (Fig. 25).

Note: Make sure the cheek pad is properly positioned in its housing, pushing in the lined corner underneath the ribbing on the shell (Fig. 26).



Fig. 27

Only for Jet helmets or flip-up helmets

- Secure the battery-holder support to the right side of the helmet, lining up the holes with the pins on the shell (Fig. 27)

- Before you place the speaker in its housing, apply the Velcro pad to the polystyrene cheek pad (right side).
- Position the loudspeaker in its housing obtained in the polystyrene cheek pad (right side).
- Replace the polystyrene cheek pad (right side), positioning the cable in the groove you see in the cheek pad.



Fig. 28

Only for full-face helmets

Insert the chin guard (microphone side), gently placing the microphone in its housing. Then press down on the red tab until the chin guard is locked in place on the helmet. (Fig. 28)



Fig. 29



Fig. 30

- Position the comfort padding in its housing (see specific instructions provided in the helmet user manual), hooking the neck roll (Fig. 29).

- Position both the comfort cheek pads in their housing (see specific instructions provided in the helmet user manual) making sure that all the press-studs click.

Note: Carefully check the proper final positioning of the cheek pad, pulling the chinstrap toward the inside of the helmet and testing the press-studs.

Caution: Make sure that there are no cables sticking out of the helmet and that the loudspeakers are in their housing.

Caution: Always verify the proper length of the chinstrap and adjust it as necessary, once again referring to the specific helmet instructions.

- Position the e-box in the relevant housing. First insert the front part, then press down on the e-box until both hooks fully click. To remove the e-box, press the two sliding hooks at the same time until the e-box comes out.

Warning: Do not leave the helmet exposed to atmospheric agents without the e-box or the protection plate provided with the helmet.

4. REMOVING THE SYSTEM

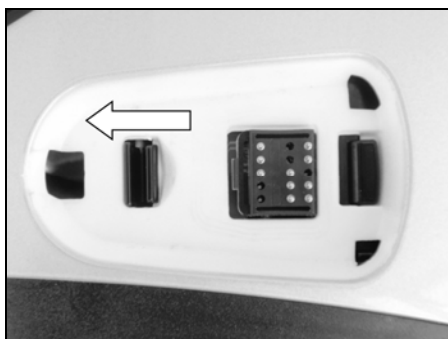

Fig. 31

To remove the system from the helmet, remove the earphone and the comfort cheek pads as shown in the assembly operations. Then remove the polystyrene cheek pads. Remove the protection plate, then, looking at the helmet from the outside, release the connector by acting on the fastening clasp as illustrated in the figure.

After releasing the connector from the shell, also remove the right part by releasing the battery holder.

Now remove the entire system from the helmet.

5. SYSTEM CHARACTERISTICS

N-Com **B1** allows wireless connection to a mobile phone, a satellite navigator, and an MP3 A2DP player using Bluetooth technology.

The system can also be used for wireless intercom communication between two helmets, if both helmets are equipped with a N-Com Bluetooth system.

The system can be expanded by means of a USB Multimedia Wire accessory (sold separately), which is used for cable connection to multimedia sources.



B1 can be managed, updated and customised using the “N-Com Wizard” programme, which can be downloaded from the “Download” section of the Internet site www.n-com.it

5.1. Basic functions

All N-Com system functions are available through the operation of three pushbuttons: “▲”, “on” and “▼”. Every time the system is given a command, a special acoustic signal can be heard, which varies depending on the function being requested. This way, all the functions can be used while wearing the helmet.

The type of command given to the system depends on how long the pushbutton is pressed.

System ON	Press “on” and keep it pressed for about 2 seconds, until the LEDs turn on and you hear a beep in the headset.
System OFF	Press “on” and keep it pressed for about 4 seconds, until the LEDs turn off and you hear a beep in the headset.
Increase Volume	Briefly press “▲” to increase the volume. A double tone signals the highest volume level.
Decrease Volume	Briefly press “▼” to decrease the volume. A double tone signals the lowest volume level.

5.2. N-Com Wizard



“N-Com Wizard” is the PC application that can be used to manage and configure the **B1** system.

The programme can be downloaded from the Internet site www.n-com.it, in the “Download” section. In order to use it, a helmet equipped with **B1** must be connected to the PC, using the USB cable supplied with the system.

N-Com Wizard allows you to customize your **B1**, specifically:

- Setting the system audio levels
- Update the device firmware

The programme includes an on-line guide that explains how it works (after installing it on your PC, press F1 to display this guide).

6. PAIRING UP BLUETOOTH DEVICES

In order for the **B1** system to be connected to another Bluetooth device, the latter needs to be first paired up with the N-Com system.

The pairing up procedure is the same for all Bluetooth devices: mobile phones, MP3 Bluetooth players, satellite navigators, etc.

1. Make sure the **B1** is turned off;
2. Press “on” and keep it pressed (for more than 6 seconds), until the LEDs start to flash quickly and you hear a sharp beep in the headset, indicating the “Pair-up mode”;
3. On the Bluetooth device, turn on the search for Bluetooth devices (refer to the instructions manual of your device for the proper pairing up procedure, as it varies depending on the brand and model of the device);
4. After a few seconds, the device will display the name “N-Com B1 v.X.XX”, followed by the manufacturer’s identification data;
5. Select the N-Com device. If a password is requested, enter **0000** (four zeros);
6. **B1** will confirm the pairing up by means of a tone in the headset, and the LEDs will stop flashing;
7. Turn off and on both the device and the **B1** to store the pairing up data.

Note: The affiliation is stored in the helmet and in the cell phone and it is not lost when the two devices are turned off. As a result it needs to be carried out only once.

Note: If a Bluetooth device (mobile phone or GPS) equipped with music player with Bluetooth A2DP player has already been paired up, the pairing up DOES NOT have to be repeated as the A2DP protocol has already been stored in the **B1**.

Once the Bluetooth device has been paired up, connection is automatic when the system is turned on.

6.1. Affiliation reset function

You can remove all affiliated devices from the system memory. This operation is not reversible; right after resetting, you will have to repeat the affiliation procedure for the cell phone (or for other compatible Bluetooth devices).

To erase all devices previously affiliated, proceed as follows:

- Press “on” and keep it pressed (for more than 4 seconds), until the LEDs start to flash quickly and you hear a sharp beep in the headset, indicating the “Pair-up mode”;
- Press “▲” and “▼” at the same time for 4 seconds, and release them when you hear a beep. The N-Com will emit a special acoustic signal to confirm and will then turn itself off.



This function can also be turned on through PC using the “N-Com Wizard” programme.

7. MOBILE PHONE FUNCTIONS

Answering a phone call	Briefly press any key when you hear the incoming call signal
Hanging up/rejecting a phone call	Press “on” and keep it pressed for about 2 seconds (until you hear the acoustic signal)
Voice call (if equipped)	Press “on” and keep it pressed for about 2 seconds (until you hear the acoustic signal)
Redial last number	Briefly press “▲” and “▼” at the same time
Transferring a call from helmet to mobile phone	To transfer an ongoing call from the helmet to the mobile phone, press both “▲” and “▼” at the same time and keep them pressed for 4 seconds

Conference call function

B1 allows a conference call with Rider and Pillion Passenger.

When a call comes in on a mobile phone connected via Bluetooth to **B1**, the Rider-Pillion Passenger intercom is temporarily turned off. However, if you wish to share the phone call with the other helmet, simply turn on the intercom manually during the phone call (by briefly pressing “on”).

Caution: this function is available only if the Pillion Passenger helmet is also equipped with a N-Com system provided with the same function.

8. GPS SATELLITE NAVIGATOR FUNCTIONS

B1 is compatible with the most common satellite navigators for motorcycles.

By connecting the N-Com system to the GPS, all instructions will be transferred to the helmet.

Every time the navigator communicates instructions, the intercom via Bluetooth with the Pillion Passenger is cut off and automatically restored at the end of the communication.

Note: If the navigator is pre-set for connection to a Bluetooth mobile phone, you will be able to receive the phone call audio directly in the helmet through the GPS. In this case, you can answer the call directly from the navigator.

GPS Conference Call Function

The Conference function allows you to keep the "Rider-Pillion Passenger" intercom open even while the satellite navigator is giving instructions, thus preventing the intercom mode to be turned off every time the navigator gives instructions. However, if you wish to activate the Conference GPS function, simply turn on the intercom manually during the GPS directions (by briefly pressing "on").

Caution: this function is available only if the Pillion Passenger helmet is also equipped with a N-Com system provided with the same function.

At the end of the GPS communication, the intercom with the second helmet stays open and the "Conference" setting is stored for future GPS communications.

9. BLUETOOTH A2DP MUSIC PLAYER

You can listen to high quality music by connecting **B1** to a device equipped with Bluetooth A2DP (Advanced Audio Distribution Profile) protocol.

The **B1** system is also equipped with Bluetooth AVRCP (Audio Video Remote Control Profile) protocol, which allows you to stop and resume music reproduction directly from the helmet (with devices equipped with AVRCP).

Connection to A2DP music player	The connection is automatic when you turn on the system. <u>Wait a few seconds for the connection.</u>
Play music (Play)	Press the "▲" button and keep it pressed for 2 seconds.
Pause function (Pause)	When the player is connected and playing music, press "▲" for 2 seconds.
Next track (Skip)	When the player is playing music, press "▲" for 4 about seconds.
Stop playing music (Stop)	Press "▼" for 2 seconds.

Note: The Bluetooth intercom does not work while listening to an A2DP audio source or an un Mp3 player connected via cable.

10. AUDIO DEVICES WITH CABLE CONNECTION

N-Com B1 allows connection via cable (sold separately) to audio sources equipped with the 3.5mm output generally used by these devices for the headsets.

To listen to the audio source, connect the cable to the helmet using the micro-USB port, then start playing the audio file on the device, then activate the audio peripheral device using the specific key.

You can turn on or off listening in the helmet by pressing the "▼" key for 2 seconds.

N.B. : You cannot stay connected in intercom mode with the pillion passenger while using the audio source via cable.

11. RIDER-PASSENGER INTERCOM MODE

In order to use **B1** in wireless intercom mode, both helmets have to be equipped with a N-Com Bluetooth system.

In order for two N-Com systems to communicate with one another, they have to be paired up first.

11.1. Intercom affiliation

1. Make sure both N-Com Bluetooth systems are turned off;
2. Set both N-Com Bluetooth systems in Pairing up mode by pressing "**on**" (for more than 4 seconds), until the LEDS start to flash quickly;
3. On either one of the two helmets, press "**on**" briefly;
4. After a few seconds, the helmets "recognize" each another, a beep is emitted to signal the pair up was successful and intercom communication is activated;
5. Turn off both N-Com Bluetooth systems and turn them back on to store the pair up data.

11.2. Intercom function

To activate the intercom connection, turn on the two N-Com systems and **briefly** press "**on**" on one of the helmets.

Intercom activation	With B1 turned on, briefly press " on ".
Intercom deactivation	With B1 turned on, briefly press " on ".

12. BATTERY

Before using the N-Com device for the first time, recharge the battery completely for at least 10 hours. To obtain best performances from the battery, it is recommended to completely recharge the battery the first few times. Afterwards, you can recharge the battery for shorter periods. Whenever possible, it is best to recharge the battery completely.

12.1. Battery discharged signal

When turned on, the system signals when the battery is running down by switching to the “**Reserve**” mode.

When the battery charging power falls below 1 hour of operation, the buttons “▲” and “▼” start to flash in order to indicate that the system is in “**Reserve**” mode. Three consecutive beeps also signal the reserve mode.

When the battery operates in “Reserve”, the system automatically turns itself off in case no button is pressed for 30 minutes. The shutting off is signaled by a series of beeps in the helmet. This function makes it possible to always have a small reserve of energy to use it again in case you forget to turn off your helmet.

12.2. Recharging the system

To recharge the **B1** system, connect the USB cable to a battery charger or to a powered USB port. Charging occurs as follows:

B1 system turned off	When you connect the B1 system to the battery charger, the blue LED begins to flash. When the battery is fully charged, the blue LED stops flashing and stays on.
B1 system turned on	When you connect the B1 system to the battery charger, the red LED begins to flash. When the battery is fully charged, the red LED turns off.

N.B.: If the device has not been charged for a long time (a few months), it may not be possible to turn on the system during the first few minutes of the charging, as the voltage may drop below the minimum limit.

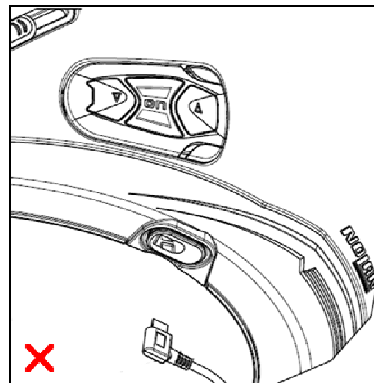
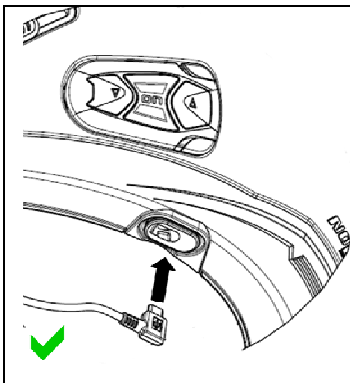

13. SUMMARY TABLE OF CONTROLS

Button		on	on	▲	▲	▼	▼	▲ ▼	▲ ▼
		Brief	Long	Brief	Long	Brief	Long	Brief	Long
Basic Functions	Turning on		X (3s)						
	Turning off		X (4s)						
	Increase Volume			X					
	Decrease Volume					X			
	Activate / Deactivate audio via cable						X (2s)		
	Activate intercom	X							
	Deactivate intercom	X							
Bluetooth peripheral	Answer phone call	X		X		X			
	Voice call		X (2s)						
	Hang up/reject a phone call		X (2s)						
	Redial last number							X	
	Mobile phone connection		X (2s)						
	Mobile phone disconnection								X (4s)
	Call transfer								X (4s)
	Activate Conference Mode	X							
Mp3 player	Connect A2DP device				X (2s)				
	Disconnect A2PD device						X (2s)		
	Play music (Play)				X (2s)				
	Pause Function (Pause)				X (2s)				
	Next track (Forward)				X (4s)				
Setting	Pairing up mode - system turned off		X (4s)						
	Rider-Passenger intercom pair up	X							
	Erase pair ups**								X (4s)

*Briefly press at the same time.

**With N-Com system in Pairing up Mode.

14. LIMITED WARRANTY

With this LIMITED WARRANTY CERTIFICATE, Nolangroup warrants this Product to be free from defects in material and workmanship at the time of its original purchase by the buyer.

We invite you to:

- Read the cautions pertaining to safety and proper use.
- Read the warranty terms and conditions.
- Keep the original sales receipt. This must be shown in case of repairs covered by warranty. In these cases, the product has to be taken back to the dealer where it was purchased.

14.1. Warranty coverage

If any defect covered by this limited warranty certificate is discovered within 2 (two) years from the purchase date shown on the tax receipt, Nolangroup shall repair or replace the defective product through its distribution network after having verified the defect. Nolangroup shall supply all the material and labor that is reasonably required to remedy the defect, except in those cases where the damage is caused by one of the items listed in the following paragraph "Exclusions and limitations of the Coverage".

14.2. Exclusions and limitations of the coverage

This warranty only covers defects in materials and manufacturing. Nolangroup shall not be considered responsible for product defects that can be attributed, either partially or in full, to any other cause, including but not limited to:

- Defects or damages resulting from using the Product in conditions that differ from the usual ones.
- Damages caused by improper use not conforming with normal operation in accordance with the product operating and maintenance instructions provided by Nolangroup.
- Negligence and normal wear of internal and external parts.
- Any damage caused by an accident;
- Any change or modification made to the helmet or to the N-com system by the user or by third parties.
- Color changes or damages caused by exposure to harmful chemical products.
- The use of incompatible accessories that are not part of the N-Com product range.
- Moreover, the warranty does not cover product defects caused by fortuitous events, modifications or adjustments, causes of force majeure or damages deriving from the product coming in contact with liquids.
- The internal helmet components are not and cannot be waterproof. Consequently, any improper exposure to rain, humidity, food spillages or other liquids can result in damages to the N-Com electronic devices, damages for which Nolangroup shall not be responsible.
- This warranty does not include those parts subject to wear and tear such as, for example, the rechargeable battery and the cables used for connection between the various N-Com systems or between the N-Com systems and other devices.
- Since Nolangroup does not supply the system on which the cell phones work, it shall not be responsible for the operation, availability, coverage, services or range pertaining to the aforementioned system.
- Whenever the product is used in conjunction with accessories or equipment not supplied by Nolangroup, Nolangroup shall not guarantee proper operation of the product/device combination, nor will it accept requests for repairs or replacements under warranty in case the product is used in such a way.

Nolangroup shall not be responsible in case the product presents limited capabilities due to the operating mode of cell phones or of other accessories or equipment not supplied by Nolangroup.

Tampering with the internal electronic card or with other parts of the N-Com system shall invalidate the warranty.

Moreover, the defects covered by this warranty do not include all those specific and subjective situations that may come up during the active use of the helmet such as, for example, comfort problems while riding or aerodynamic noises.

Nolangroup shall not be held responsible in any case for incidental or consequential damages (including, without any limitation whatsoever, damages to one or more persons) resulting from non-fulfillment of the obligations arising from this warranty as it pertains to Nolangroup products.

14.3. Validity of this limited warranty

This warranty is valid only if the enclosed warranty form is duly and completely filled out with the following information:

- Product identification code

- Name and stamp of the authorized dealer.
- Product purchase date.
- Buyer's name and address.

Nolangroup reserves itself the right to not carry out repairs under warranty if the aforementioned information is removed or modified after the original purchase of the product from the dealer.

14.4. Procedure for the forwarding of claims

To forward a claim covered by this warranty, the buyer has to directly notify the dealer where the helmet was purchased with regards to the defect, presenting at the same time the defective product, a copy of the sales receipt and the Warranty registration form, duly filled out as instructed above.

PRIOR TO CONTACTING THE DEALER, WE RECOMMEND THAT YOU READ CAREFULLY THE USER MANUAL ENCLOSED WITH THE PRODUCT.

AFTER 2 (TWO) YEARS FROM THE DATE OF PURCHASE, THIS LIMITED WARRANTY IS VOID FOR ALL EFFECTS AND PURPOSES.

Repairs or maintenance under warranty do not extend the period of the warranty itself. Therefore, in case the product or one of its components is replaced, this does not initiate a new warranty period, as the purchase date of the original product shall be taken into account for warranty purposes.

Only for repairs or replacement of electronic components, in the event that Nolangroup proceeds to repairing or replacing the product, said product shall enjoy a warranty period equal to the residual portion of the original warranty or ninety (90) days from the repair date (the longer period being considered).

The repair or replacement can be carried out even with regenerated components with equivalent functions.

The replaced parts or components shall become property of Nolangroup.

THIS WARRANTY VOIDS AND REPLACES ANY OTHER WRITTEN OR VERBAL WARRANTIES PROVIDED FOR BY THE LAW THAT CAN BE DEROGATED AT THE PARTIES' WILL; SPECIFICALLY, NOLANGROUP DOES NOT GRANT SPECIFIC WARRANTS OF MERCHANTABILITY OR FITNESS FOR A PARTICULAR PURPOSE. IN NO CASE SHALL NOLANGROUP BE LIABLE FOR INCIDENTAL OR CONSEQUENTIAL DAMAGES INCLUDING BUT NOT LIMITED TO LOST PROFITS OR COMMERCIAL DAMAGES, TO THE FULL EXTENT THOSE DAMAGES CAN BE DISCLAIMED BY THE LAW.

NOLANGROUP RESERVES ITSELF THE RIGHT TO MODIFY, AT ANY TIME AND WITHOUT ADVANCE NOTICE, THE PRODUCT CHARACTERISTICS, FUNCTIONS, COMPATIBILITY AND SOFTWARE.

Some Countries do not allow the exclusion or limitation of incidental or consequential damages, or the limitation of the duration of implied warranties; as a result of this, the previous limitations and exclusions may not be applicable to you.

This warranty does not have any effect on the customer's legal rights under the national jurisdiction in force or on the consumer's rights towards the dealer sanctioned by the purchase/sale contract.

This warranty is valid throughout the European territory, and it represents the only express warranty provided by Nolangroup in relation to the sale of its own products. This warranty does not affect the rights to which the buyer is entitled and which are expressly provided for by Directive 1999/44/CE.

This warranty does not affect the consumer's rights provided for by the law, and specifically by the provisions of Legislative Decree 2 February 2002 n. 24.

14.5. Product identification

N-Com products are identified by means of a code that allows product traceability and identification.

The identification code is found underneath the bar code printed on the product packaging.



15. WARRANTY REGISTRATION FORM

Product name: **B1**

Identification code

--	--	--	--	--	--	--	--	--	--	--	--	--	--	--	--

Buyer's Information

Name

Last name

Address

Phone

e-mail

Dealer's stamp

Date of purchase

