

Operating Instructions

Model: PRTHW-TS WiFi RF



01/13 Version 1
Ref: PRTHW-TSWIFI RF

Contents Page

Setting up your WiFi Thermostat	2-5
Remote Connection Setup	6-9
Pairing with the Receiver	9-12
Display Symbols Explained	16
Installation Procedure	17-18
Setting the Clock	19
Comfort Levels Explained	20
Setting The Hot Water Switching	23
Hot Water Override	23
Locking the Keypad	24
Temperature Override	24
Temperature Hold	25
Holiday	25
Heat On/Off	26
Clean Screen	26
Factory Reset	26
Optional Feature Setup	27-32
Re-calibrating the Thermostat	33
Wiring Diagrams	34-35

Setting up your WiFi Thermostat

Step 1: Download and install the network utility from our web site: www.heatmiser.co.uk/wifi

Step 2: Connect the thermostat to your pc with the USB cable provided, this will power the thermostat from the USB port & will allow you to test the Wi-Fi connection.

On the Utility press Read to view the current thermostat configuration.

Step 3: You should enter the SSID, Security Type and Security Code of your wireless network. These settings can be found in your wireless router, consult your router manual for more information. For more details see security types below.

Step 4: You need to enter a fixed IP address for your Wi-Fi Thermostat outside of the router DHCP range.

It is likely that your network will be configured to operate on a DHCP basis – this means your router automatically issues an IP address to a device that successfully connects to the network.

Your Wi-Fi thermostat needs a fixed IP address in order for local and remote access to operate, so you will need to set this up manually.

Log into your wireless router and navigate to the LAN settings page. You should see an option for DHCP setup. This should detail the IP range that can be assigned to devices connecting to the network.

As an example, you may have an IP starting range 192.168.1.1 and ending 192.168.1.99.

This would mean you can safely provide your Wi-Fi Thermostat the IP address 192.168.1.100 as no other devices will be assigned this address by the router.

If your DHCP range is from 192.168.1.1 to 192.168.1.253 you cannot use 254 or above, you will need to change the DHCP range, taking care not to change any of the first 3 numbers.

Tip! When setting up an IP address, the first three sets of numbers must be the same as the router IP, the fourth set must not be used elsewhere on the network.

Step 5: Enter the Subnet mask for the network, this information can be found in your wireless router.

Step 6: You need to enter the IP address of your gateway and DNS. In most cases, this is the IP address of your wireless router. If you are using the Multi-Link on the system, the gateway of the thermostat will need to be the IP address of the Multi-Link.

Step 7: *Browser Username & Password*

You should now create a username and password that is used when you access your thermostat from a web browser. The default username is admin and the default password is also admin.

Access PIN

The access PIN is required when you are using the iPhone app and helps secure your system. This PIN should be entered in the Network Setup screen.

Step 8: *Checking Connection*

Once you have entered the details of your Wi-Fi network press Apply and disconnect your thermostat wait 5 seconds then reconnect it. Once the thermostat has rebooted wait approximately one minute, you should then see the Wi-Fi symbol on the display indicating the Wi-Fi Thermostat has successfully connected to your network. The Wi-Fi symbol is 3 curved lines just below the OFF button.

Security Types & Compatability Explained

The Wi-Fi Thermostats operate on the 802.11b standard. If your router is a G model, you should ensure it is setup to work in B&G mode otherwise you will not be able to connect to your thermostat.

There are currently 4 methods of securing your wireless connection in common use

These are :

- OPEN/DISABLED (not recommended)
- W.E.P. (lowest security level)
- W.P.A. (medium security)
- W.P.A.2. (highest security)

Your choice of security settings in the thermostat must match the setting in your router. Quite often you will find WPA and WPA2 as a single option in the router this is perfectly normal the router knows which one to use, and you can therefore set the thermostat up using either one. The password can be up to 63 characters in length including spaces _ . / \ characters.

The W.E.P. option is not so simple. Some routers generate a hidden password from a pass phrase whilst others require a

10 or 26 digit hex password and won't accept anything else. Your thermostat utility can deal with both options.

The following restrictions apply:

A hex password can only be made up of the numbers 0 to 9 and the letters a to f, lower case only.

Hex passwords can only be 10 characters or 26 characters in length.

If a passphrase is used it must be either 5 or 13 characters in length but can be any letter or number.

Your thermostat will automatically calculate the same hidden password your router creates from the same phrase.

You will find most routers have these same restrictions.

Remote Connection Setup

In order to connect to your WiFi thermostat remotely, you need to forward ports within your router to the WiFi thermostat.

This is usually configured in the Port Forwarding section of the router, as all routers are configured differently, you will need to consult your router user manual or the manufacturers website for more information.

As a brief outline, you should first create a new service within your router, specifying the port number and the IP address to forward to, the port numbers needed are explained below.

Remote access via smartphone/tablet

To access your WiFi thermostat remotely via smartphone or tablet, you need to forward port 8068 to the IP address of your WiFi thermostat.

Remote Access via Web Browser

To access your WiFi thermostat remotely via web browser, you need to forward port 80 to the IP address of your WiFi thermostat.

Connecting to the Thermostat from your Web Browser

To connect to your thermostat, open your preferred browser and enter the IP address that you gave the thermostat during setup and press enter. You will now be asked for a password and username, these are both “admin” as default. We recommend you change these settings to ensure the security of your system.

For further information, click the help link within the browser.

Connecting to the Thermostat from your Smartphone or Tablet application

To connect to your thermostat, launch the app on your smartphone or tablet, there are now three sections to fill in.

Lan IP – This is the static IP address you have assigned to the WiFi thermostat.

WAN IP – This is either your static IP address or Dynamic DNS address when connecting to your network remotely.

PIN – This is the four digit pin number assigned to the WiFi thermostat on configuration.

Once this information has been entered the app will store this for the next time you connect.

Pairing the Thermostat with the RC1-W receiver

If using the UH1-W wiring centre as the receiver turn to page 8

On the RC1-W:

Press & hold the pairing button on the RC1-W receiver until the comms led lights up.

On the PRTHW-TS WiFi RF:

- Press Prog then Setup.
- At the top of the screen press the Up button to select feature 06.
- Use the up/down buttons in the centre of the screen & set the large number to 01, this configures the thermostat to communicate with the RC1-W.
- Press the UP button at the top of the screen to select feature 07.
- Use the up/down buttons in the centre of the screen to select the RC1-W receiver address you are communicating with.(01-32)
- The heating output will be automatically assigned to zone 1 and the hot water will be zone 2.
- Press the DONE button.

To pair the thermostat with the receiver, press & hold the SCREEN button for 10 seconds:

Pair Successful

The address of the receiver will flash on the thermostat display & the comms led will flash on the RC1-W receiver. Press DONE on the thermostat to confirm pairing with the RC1-W receiver.

Pair Fail

If the Comms LED on the receiver does not flash, there could be a problem with the RF signal. Reduce the distance between the thermostat and receiver, where possible check that no metal objects are blocking the signal. Also check that features 06 – 08 have been configured correctly.

Pairing the thermostat with the UH1-W

On the UH1-W:

Set the board id number on the UH1-W by selecting from 01-09 indicated on the rotary switch. Each UH1-W on the system will need a different id number.

On the PRT-TS WiFi RF:

- Press Prog then Setup.
- At the top of the screen press the Up button to select feature 06.
- Use the up/down buttons in the centre of the screen & set the large number to 00, this configures the thermostat to communicate with the UH1-W.
- Press the UP button at the top of the screen to select feature 07.
- Use the up/down buttons in the centre of the screen to select the UH1-W board id number you are communicating with. (01-09)
- Press the up button at the top of the screen to select feature 08.

- Use the up/down buttons in the centre of the screen to select which zone number on the UH1-W you are assigning the thermostat to. (01-08)
- Press the up button at the top of the screen to select feature 09.
- Use the up/down buttons in the centre of the screen to select if the thermostat will bring on the pump & boiler outputs. 00=UFH (Outputs enabled) 01=Radiator (Outputs not enabled).
- Press the Done button.

Testing the communications with the UH1-W

On the thermostat use the Up button and take the set temperature above the room temperature then press done.

You will now see the flame symbol and after a few seconds the assigned zone on the UH1-W should now be active.

If the output on the UH1-W does not come on, reduce the distance between the PRTHW-TS WiFi RF and UH1-W also check features 06-09 have been configured correctly, then repeat the above process.

What is a programmable room thermostat?

A programmable room thermostat is both a programmer and a room thermostat. A programmer allows you to set “On” and “Off” time periods to suit your own lifestyle. A room thermostat works by sensing the air temperature, switching on the heating when the air temperature falls below the thermostat setting, and switching it off once this set temperature has been reached.

So, a programmable room thermostat lets you choose what times you want the heating to be on, and what temperature it should reach while it is on. It will allow you to select different temperatures in your home at different times of the day (and days of the week) to meet your particular needs.

Turning a programmable room thermostat to a higher setting will not make the room heat up any faster. How quickly the room heats up depends on the design of the heating system, for example, the size of the boiler and radiators.

Neither does the setting affect how quickly the room cools down. Turning a programmable room thermostat to a lower setting will result in the room being controlled at a lower temperature, and saves energy.





The way to set and use your programmable room thermostat is to find the lowest temperature settings that you are comfortable with at the different times you have chosen, and then leave it alone to do its job.

The best way to do this is to set low temperatures first, say 18°C, and then turn them up by one degree each day until you are comfortable with the temperatures. You won't have to adjust the thermostat further. Any adjustment above these setting will waste energy and cost you more money.

If your heating system is a boiler with radiators, there will usually be only one programmable room thermostat to control the whole house. But you can have different temperatures in individual rooms by installing thermostatic radiator valves (TRVs) on individual radiators. If you don't have TRVs, you should choose a temperature that is reasonable for the whole house. If you do have TRVs, you can choose a slightly higher setting to make sure that even the coldest room is comfortable, then prevent any overheating in other rooms by adjusting the TRVs.

The time on the programmer must be correct. Some types have to be adjusted in spring and autumn at the changes

Wi-Fi Thermostat Display Guide V1.0

	Shown on the PRT-ETS WiFi Model. Displayed when the floor temperature rises above the floor limit temperature.
ROOM TEMP	Indicates the current room temperature.
FLOOR TEMP	Indicates the current floor temperature (PRT-ETS WiFi Only).
	Indicates the thermostat is in Away Mode.
	Indicates the thermostat has successfully connected to the Wi-Fi Router.
	Indicates the heating output is on.
	Indicates the thermostat is locked.
TIMER ON TIMER OFF	Indicates whether the hot water output is on or off.
°C F	Temperature Format Display.
CLEAN SCREEN	Shown when the thermostat is in "Clean Screen Mode" During this mode, all buttons are disabled to allow for cleaning of the thermostat.
HOLIDAY LEFT	Shown during a holiday to indicate holiday time remaining.
HOLD	Shown during a hold period to indicate the hold time remaining.
WAKE	Wake, Leave, Return, Sleep are the 4 comfort settings available.
TIME 1	Time 1-4 are available only on the PRTHW and TM1 versions.

between Greenwich Mean Time and British Summer Time. You may be able to temporarily adjust the heating programme, for example, “Override”, “Advance” or “Boost”. These are explained in the manufacturer’s instructions. Programmable room thermostats need a free flow of air to sense the temperature, so they must not be covered by curtains or blocked by furniture. Nearby electric fires, televisions, wall or table lamps may prevent the thermostat from working properly.

Installation Procedure

DO's

1. Do mount the thermostat at eye level.
2. Do read the instructions fully so that you get the best from our product.

DON'Ts

1. Do not install near a direct heat source as this will affect the workings of the thermostat.
2. Do not push hard on the LCD otherwise you will damage the liquid crystal display and this is not repairable.

Installation

The thermostat is designed to be flush mount, a back box of 35mm should have been sunk in the wall prior to installation.

Step 1

Carefully separate the front half of the thermostat from the back plate by placing a small flat head terminal driver in to the slots on the bottom face of the thermostat.

Step 2

Place the thermostat front half somewhere safe.
Terminate the thermostat as shown in the diagrams at the back of this booklet.

Screw the thermostat back plate on to the back box.

Step 3

Re-connect the two parts of the thermostat

Temperature Display

Room Temp = This is the current room temperature.

SET = This is the temperature you are trying to achieve in your home.

Timer ON/Timer OFF = This is the status of the hot water output.

Setting The Clock

To set the clock, follow these steps:

- Press Prog
- Press Clock
- Enter the Time (In 24hr Format)
- Press Clock
- Enter the day and month
- Press Clock
- Enter the Year
- Press Done

The clock can also be set via the Browser or app.

Comfort Levels Explained

Comfort levels allow you to set different temperatures throughout the day. For example, you may want the home warm in the morning when you are getting ready for work, cooler during the day when the house is unoccupied and then warmer in the evening when you are home relaxing. The thermostat offers 5/2 Day Programming (4 levels for the weekday, 4 for the weekend) and 7 day Programming (4 levels for each day). See pages 25-30 for details on how to switch between these modes.

Tip! If you don't want to use all of the comfort levels, just set the time to --.— and the thermostat will ignore this setting.

Factory Programmed Comfort Levels

The following comfort levels are programmed already, however you can change them easily.





Weekday Level

	Time	Temp
Wake	08.00	21°C
Leave	09.30	16°C
Return	16.30	22°C
Sleep	23.00	17°C

Weekend Level

	Time	Temp
Wake	09.00	21°C
Leave	22.00	16°C
Return	--.--	--°C
Sleep	--.--	--°C





Changing the Comfort Levels

- Press PROG and select Wake.
- Use   to set the time for the 1st Comfort level.
- Use   to set the temperature in °C.
- You should now repeat for the Leave, Return & Sleep levels.
- Press Day to select the next day. In 5/2 day mode the thermostat will highlight “Sat Sun” prompting you to program the temperature levels for the weekend. In 7 day mode, the thermostat will highlight Tuesday.
- When complete, press Done to Store and Exit.

Hot Water Timings Explained

The PRTHW-TS WiFi offers an additional timed output for the hot water cylinder. The thermostat offers 5/2 Day Programming (4 levels for the weekday, 4 for the weekend) and 7 day Programming (4 levels for each day). See pages 25-30 for details on how to switch between these modes.

Changing the Hot Water Times

- Press PROG and select Timer
- You will see TIME 1 and ON flash
- Use   to set the on time for the 1st switching time
- Press Off and then use   to set the off switching time.
- You should now repeat for the Time 2-4
- Press Day to select the next day. In 5/2 day mode the thermostat will highlight “Sat Sun” prompting you to program the switching times for the weekend. In 7 day mode, the thermostat will highlight Tuesday.
- When complete, press Done to Store and Exit.

Hot Water Override

The thermostat has an override function for the hot water output allowing you to override the hotwater into the opposite state.

- Press Hold
- Press Timer
- If the hotwater is already On – press Off
- If the hotwater is already Off – press On



You will then see the hotwater status change and the hotwater output indication will flash to show it has been overridden from the programmed setting. The hotwater will remain in the override state until the next programmed time. To cancel, repeat the steps above.

Locking the Keypad

The thermostat has a keylock facility. To enable this press the bottom right corner of the display and hold for 10 seconds.

When activated, you will see  .
To cancel, repeat the steps above.

Temperature Override

Using the   keys allows you to adjust the set temperature. When you press either of these keys, you will see the word SET and the desired temperature. Press Done to accept.

Note: You should note that this new temperature is maintained only until the next programmed comfort level. At this time, the thermostat will revert back to the programmed levels.

Temperature Hold

The Temperature Hold function is ideal for parties or when you will be going out for a number of hours. It allows you to hold a temperature for a desired period.

- Press HOLD.
- Set the desired Hold time and temperature.
- Press Done.
- To cancel a Hold time, reduce the time to 00.00.

Holiday

The Holiday function reduces the set temperature in your home to the frost temperature setting. The thermostat will maintain this temperature for the duration of the holiday and will then automatically return to the program mode on your return.

Assume you program a holiday on Monday for 1 day, the holiday will start immediately, but the thermostat will count the next day (Tuesday) as the holiday. The thermostat will then revert back to its program at Midnight Tuesday.

- Press HOLIDAY.
- Enter the duration of your holiday.
- Press Done.
- To cancel a Holiday, reduce the Holiday time to 00 days.

Heat On / Off

Frost Protect Mode: Pressing the Off button once will place the thermostat in frost protect mode. In this mode, the thermostat will display the frost icon and will only turn the heating on should the room temperature drop below the set frost temperature (see pages 25-30). Should the heating be turned on whilst in frost mode, the flame symbol will be displayed. To cancel the frost protect mode, press the Off button.

Thermostat Off: To turn the thermostat off completely, press and hold the OFF button. The display and heating output will be turned off. To turn the thermostat back on, press the ON button once.

Clean Screen

Pressing Clean Screen will disable all buttons, allowing you 15 seconds to wipe the screen clean.

Factory Reset

The thermostat has a factory reset function. This will reset all settings back to their factory default.

To perform a factory reset, follow these steps:

Turn off the thermostat by pressing and holding the off button. Press and hold the bottom left corner of the LCD for 10 seconds. You will see all the icons appear for 2 seconds and then disappear. You now need to power down the thermostat for 5 seconds and then power on again.

THE FOLLOWING SETTINGS ARE OPTIONAL AND IN MOST CASES NEED NOT BE ADJUSTED

Optional Features Explained

Feature 01 – Temperature Format: This function allows you to select between °C or °F.

Feature 02 - Switching Differential: This function allows you to increase the switching differential of the thermostat. The default is 1°C which means the thermostat will switch the heating on 1°C below the set temperature and will turn it off when the set temperature is achieved. With a 2°C differential, the heating will switch on 2°C below the set temperature and will switch off when the set temperature is achieved.

Feature 03 - Frost Protect: You can set whether the thermostat will maintain the frost temperature when the thermostat display is turned off. As a default, this is enabled.

Feature 04 – Frost Protect Temperature: This is the temperature maintained when the thermostat is in frost mode. The range is 07-17°C. The default is 12°C and is suitable for almost all applications.

Feature 05 – Output Delay: To prevent rapid switching, an output delay can be entered. This can be set from 00-15 minutes. The default is 00 which means there is no delay.

Feature 06 – UH1-W or RC1-W Receiver: The thermostat can work with our UH1-W or RC1-W. This setting determines which is being used. 00 = UH1-W, 01 = RC1-W

Feature 07 – Receiver Address: Within one building, up to 9 UH1-W's or 32 RC1-W receivers can be used. Each receiver must have a unique receiver address.

Feature 08 – Zone Number: This is the zone number you are assigning the thermostat to on either the UH1-W or the RC1-W receiver. 01-08 - UH1-W, 01-02 – RC1-W

Feature 09 – Underfloor Heating or Radiator Zone (UH1-W Only): This setting determines whether the thermostat will activate the pump & boiler output on the UH1-W. If set to 00 the outputs will be activated.
00 = UFH, 01 = Radiators

Feature 10 – Fail Safe: If enabled, the thermostat will send a signal to the receiver every 20 minutes. Should the receiver fail to receive two signals, the receiver will activate the output for 20% of the time. This is to protect the system against a loss of wireless signal or should the thermostat battery fail whilst you are away.

Feature 11 – Temperature Up/Down Limit: This function allows you to limit the use of the up and down temperature arrow keys. This limit is also applicable when the thermostat is locked and so allows you to give others limited control over the heating system.

Feature 12 - Sensor Selection: On this thermostat you can select to use the built in sensor (00) or remote air sensor (01).

Feature 13 – Floor Limit Sensor: This function does not apply to this model.





Feature 14 – Optimum Start: Optimum start will bring the heating on early if needed, so the house is warm when you wake up. This means you don't need to allow any extra heat up time when programming the comfort levels. The thermostat will automatically learn the required heat up time and will adjust itself, if required, throughout the year.

Feature 15 – Rate Of Change: This is the number of minutes the thermostat has calculated it takes to raise your building 1°C. The thermostat will continue to learn the heat up time of your home and will adjust this setting to suit.

Feature 16 – 5/2 Day 7 Day Programmable: This function allows you to switch between 5/2 day or 7 day programming. 5/2 day means you can program 4 comfort levels for the weekday and 4 different levels for the weekend. 7 day programming allows you to program 4 temperature levels for each day of the week.

Adjusting the Optional Settings

To adjust the settings, follow these steps:

- With the thermostat turned on.
- Press PROG.
- Press SETUP.
- Use the   at the top of the screen to select the feature number (shown on pages 29-30) and then use the   keys in the centre adjust the setting.
- Press Done to accept and Store.

Feature Table

Feature	Description	Setting
01	Temperature Format	00=°C 01=°F
02	Switching Differential	0.5=0.5°C - 3.0=3°C 1.0°C = Default
03	Frost Protect	00 = Disabled 01=Enabled (01=Default)
04	Frost Temp	07-17°C (12=Default)
05	Output Delay	Enter value 00-15 minutes (00=Default)

Feature Table (Continued)

Feature	Description	Setting
06	Receiver Type	00 = UH1-W 01 = RC1-W
07	Receiver Address	UH1-W = 01-09 RC1-W = 01-32
08	Zone Number	UH1-W = 01-08 RC1-W = 01-02
09	Under-floor Heating or Radiators <small>(UH1-W Only)</small>	00 = UFH 01 = Radiators
10	Fail Safe	00 = Disabled 01 = Enabled
11	Temp Limit	00 – 10°C
12	Sensor Selection	00 = Built In Sensor 01 = Remote Air Sensor
13	Floor Limit	Not used on this model
14	Optimum Start (Preheat)	00 = Disabled (Default) 01=1 hour, 02=2 hours, 03=3 hours
15	Rate Of Change	For information only
16	Program Mode	00 = 5/2 Day (Default) 01 = 7 Day

Re-calibrating the thermostat

If you need to re-calibrate the thermostat follow these instructions:

1. Press and hold the OFF button to turn the thermostat off.
2. Press and hold the ON button until the temperature appears on the screen.
3. Use the up/down buttons to set the new temperature.
4. Press DONE to accept.
5. Press the ON button once to turn the thermostat back on.

Heatmiser PRTHW-TS WiFi RF Model

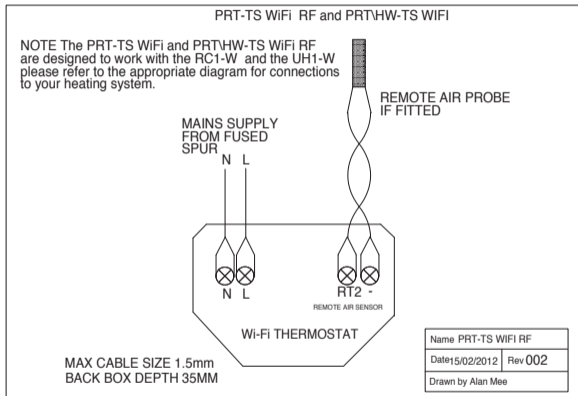

Heatmiser PRTHW-TS WiFi RF Model

