

# 2.4GHz Digital Wireless Video Door Phone User Manual



## Contents

1. Introduction .....	2
2. Features .....	2
3. Packing list .....	3
4. Outdoor camera .....	4
5. Indoor monitor .....	4
6. Installation instructions .....	5
7. E-lock installation .....	7
8. Operation .....	9
9. Working environment .....	14
10. Notices .....	14
11. Specifications .....	14
12. Failure diagnosis .....	15

- Thank you for purchasing our product.
- Please carefully read this user manual before using the product and follow the manual to install and operate.

## 1. Introduction

The product is applicable in office, house, apartment, hotel, building and so on.

The outdoor camera is easy to install. Indoor monitor is portable. It can be hung on the wall, or be placed on the desk.

## 2. Features

- (1) 2.4GHz digital frequency hopping and encryption technology, transmission distance up to 400 meters in free field, robust anti-interference
- (2) Clear night vision can capture image in low-illumination environment
- (3) Rain shield for the outdoor camera is available
- (4) 3.5 or 7 inch TFT color panel for indoor monitor
- (5) Surveillance, unlock, hands-free call and talk
- (6) 16 chord melodies and melody volume is adjustable
- (7) Brightness and talk volume are adjustable
- (8) Date (only one camera with one monitor system) and time shown on the screen
- (9) Indoor monitor could take pictures automatically or by instruction. It could store up to 100 pictures with date and time
- (10) BL-5J battery of camera and monitor is replaceable and rechargeable
- (11) Outdoor camera works about 30 days if with battery. It works all the while if connected with the 2w solar module. Or it works all the while if power adapter is connected.
- (12) Wireless unlock control supports power on and power off unlock
- (13) One outdoor camera supports up to 4 indoor monitors and vice versa

## 3. Packing list



### Outdoor camera part

- (1) Outdoor camera (2) Power adapter Input: 100-240V 50/60Hz Output: 5V/1A  
(3) double-sided tape (4) Wireless unlock control (5) Screws and stoppers  
(6) DC cable



- (7) Remote control (optional) (8) BL-5J battery (optional)  
(9) Solar module charger (optional) (10) 6meters or 10meters antenna

### Indoor monitor part

- (11) 3.5" indoor monitor or 7" indoor monitor  
(12) Fixed iron for 7" indoor monitor (13) BL-5J battery (14) USB Cable  
(15) USB power adapter; Input: 100-240V 50/60Hz Output: 5V/1A (16) User manual

## 4. Outdoor camera

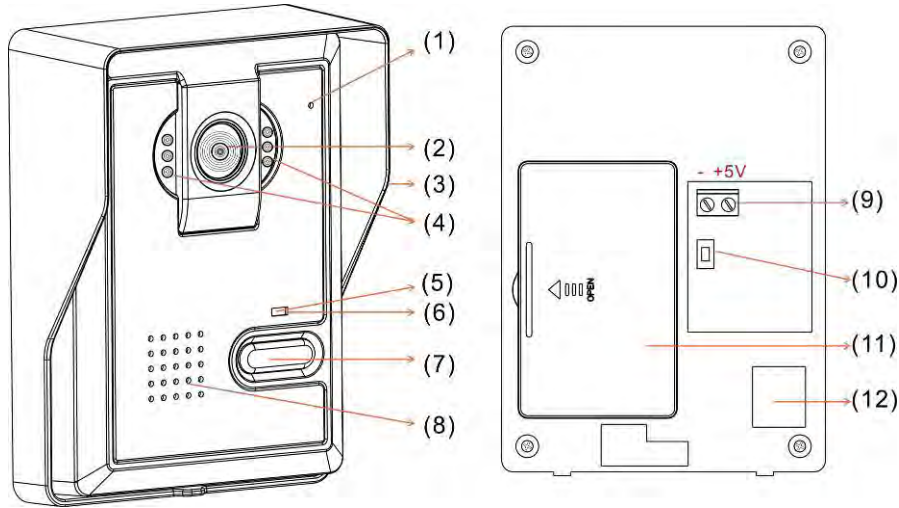

- (1) Microphone (2) Camera lens (3) Rain shield (4) Infrared light  
 (5) Indicating light for recharge  
 (6) Indicating light, show green if press 'pair' or 'call' button, show red if low voltage  
 (7) 'Call' button (8) Speaker (9) Adapter interface (10) 'Pair' button  
 (11) Battery lid of BL-5J (12) Obligate area welding antenna

## 5. Indoor monitor

### (A) 3.5" indoor monitor

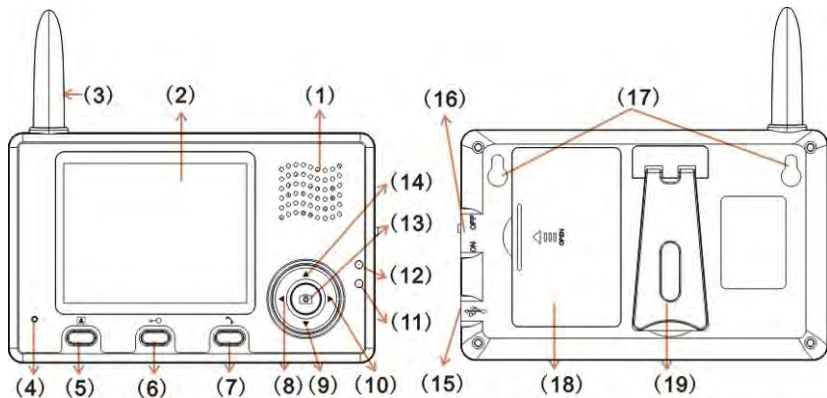

### (B) 7" indoor monitor

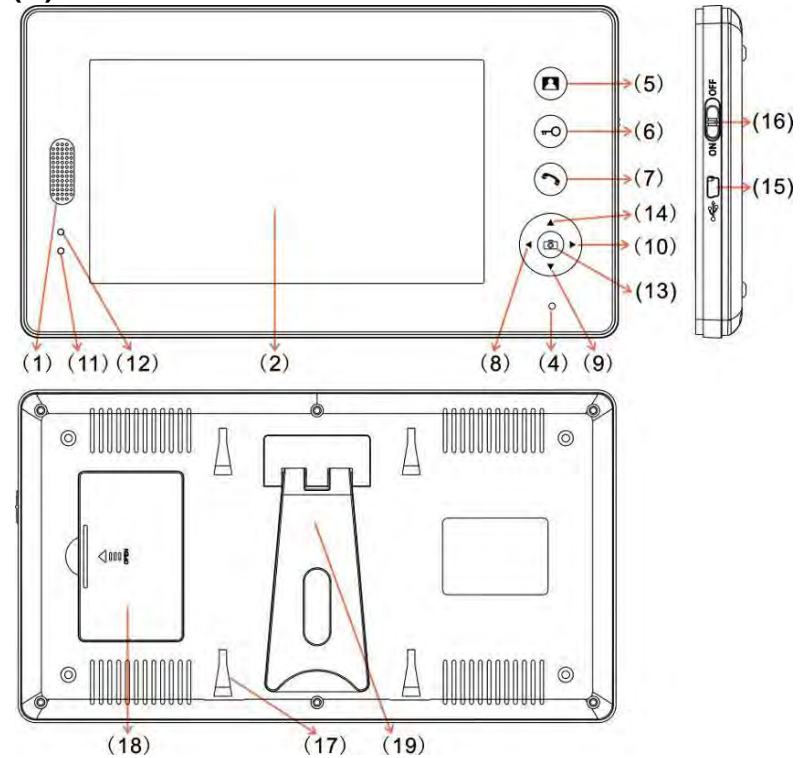

- (1) Speaker (2) TFT screen (3) Antenna (4) Microphone  
 (5) 'Monitor' button (6) 'Unlock' button (7) 'Talk' button  
 (8) Left (9) Down (10) Right (11) charging light  
 (12) Working light (13) 'Take picture' button (14) Up (15) USB interface  
 (16) Power switch (17) Fixed slot (18) Battery lid of BL-5J (19) Bracket

## 6. Installation instructions

The outdoor camera should be installed at the shielded position to be free from direct shining of strong light or raining. The height for installation is recommended to be 1.5~1.7m for outdoor camera to focus on the best monitoring range. Wireless signal will be weakened if there are obstacles between the outdoor camera and the indoor monitor. Please check the best sign of monitor when install the outdoor camera to get the best position.

If wiring needs to go through wall, the plug should be firstly wrapped with tape so as to avoid the sand or dirt going into the plug thus resulting in malfunction.

Use double-sided tape fix camera on the wall or door as the following diagram.

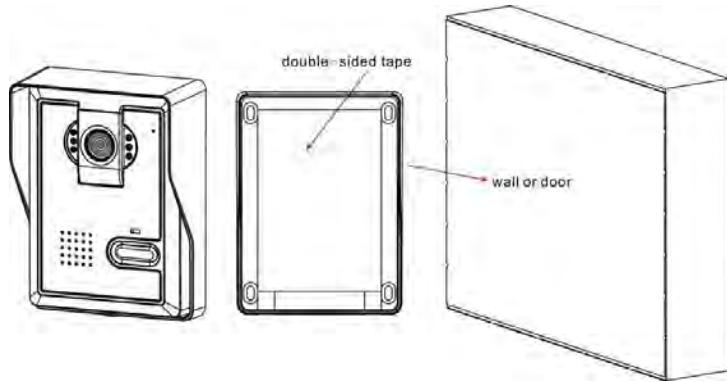

Take off the screw on the bottom, remove the back box fit on the wall, embed the camera to the back box and use screws to fix as the following diagram.

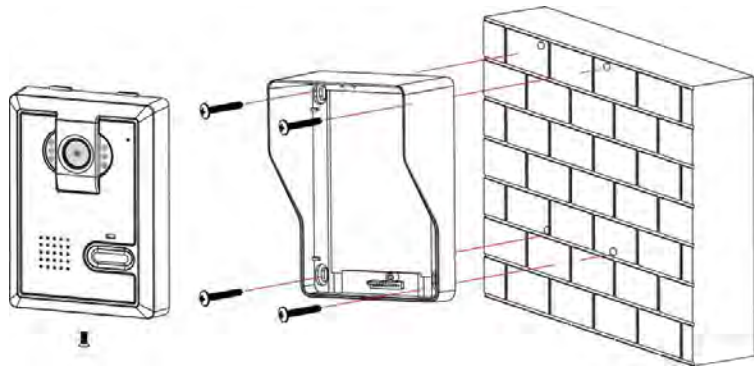

If it is inconvenient for the user to install power adapter near outdoor camera, user can also select solar panel module and rechargeable battery for outdoor camera. But the solar panel module and rechargeable battery are not included in the product package list.

The  $V_{mp}$  and  $I_{mp}$  of the 2w solar panel module are 5v and 400mA respectively.

The wire between solar panel module and camera length is 6 meters. You'd better put the solar module on the place the sun can directly shine. The battery costs 3~4hours to be fully charged by strongly directly shinning. Outdoor camera can work about 30 days each full recharge.



## 7. E-lock installation

E-lock and power of e-lock are not included in this product. Wireless unlock control connects e-lock, shares 12V power adapter with e-lock when it works.



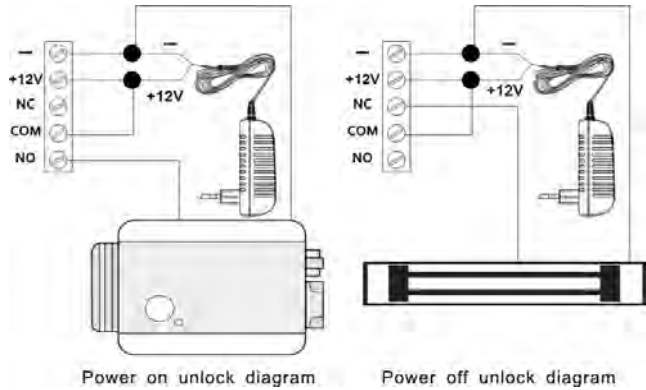

Notes: The distances between wireless unlock control and outdoor camera should be within 10 meters so that the wireless unlock control is able to receive unlock command. The remote control uses 27A/12V battery. presses of remote control to unlock. The work distance between remote control and unlock control should be within 15 meters.

Schematic diagram

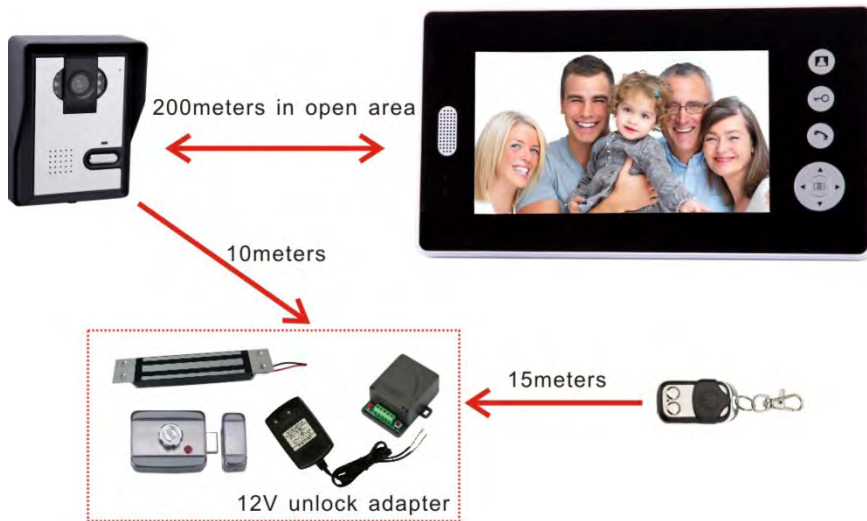

The system can work together with intelligent lock, Intelligent lock uses 4pcs AA batteries.



## 8. Operation

**Note:** When the system is in working condition, if there is no blocking wall between indoor monitor and outdoor camera, you must keep them at least 6 meters apart to avoid the 'whistle' sound.

### A Setting

#### (1) Date and time

When indoor monitor is in non-talk mode, press button for 3 seconds, there will be a "T" (for time) character on the left side of the battery symbols on the screen. User can set the date (year/month/day) and the current time (hour/min). Time format is 24 hours. Only one outdoor camera with one indoor monitor is available for date setting. Press , button to select, press , button to adjust the date and time in grey.

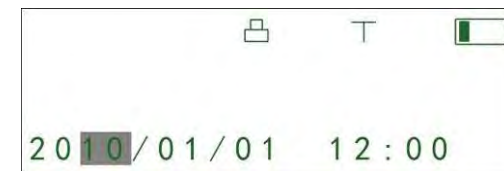

## (2) Melody and volume

When indoor monitor is in non-talk mode, press ► button to select one of the 16 chord melodies as the sound of the bell. Press ◀ choose to the volume of melody (adjust level: 1-2).

16 chord melodies are Ding-dong, To Alice, Westminster bell, Butterfly lovers, The cygnet, Red river valley, My heart will go on, Turkey's march, Small dance, Congratulations you, William's prelude, Love romance hudson, Memory, The Little Mermaid, Green sleeves, Romeo and Juliet.

## (3) Talk volume

In the talk mode, press ◀, ► to adjust the talk volume. Adjust level: 0-7.



## (4) Brightness

In the talk mode, when indoor monitor has dynamic image from outdoor camera, press ▲, ▼ to adjust brightness. Adjust level: 0-7.



## B Operation

### (1) Indoor monitor turn on/off

**Turn on:** Turn the power switch to "ON", working light display red and rings the melody.

**Turn off:** Turn the power switch to "OFF", working light off.

Maximum Com-sign is level 6. Maximum battery bar is level 4.

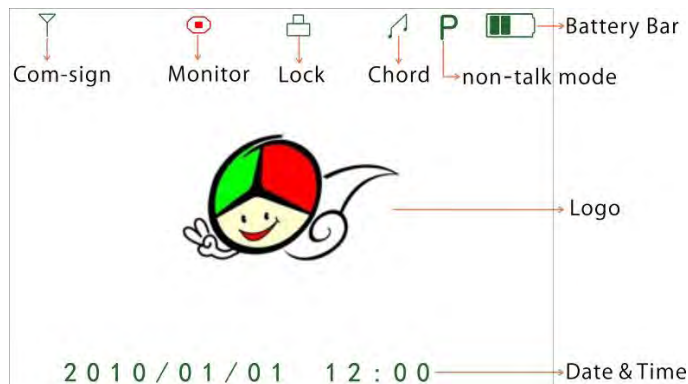

## (2) Talk, unlock

The visitor presses the "call" button of the outdoor camera. All indoor monitors will sound melody.

- A. Press ↶ button of one indoor monitor to speak to visitor before unlock. Other indoor monitors can see the image but can not hear sound of the visitor. If you want to let other indoor monitor to talk, press ↶ button to end the current dialogue, then another indoor monitor could press ↶ button to speak to visitor.

When in talk mode, press 🔓 button to unlock the door lock, the unlock signal shows on the screen. When press 🔓 button again, the unlock signal will disappear.

Press 🧑 button to turn off the screen and enter standby mode, or it will turn into standby mode automatically after 30 seconds.

- B. If do not want to let the visitor go in after seeing the video, no operation or press the 🧑 button to turn off the screen and then enter into standby mode.

Indoor monitor enters into the standby mode after 30 seconds if no any operation.

Note: if you use multiple indoor monitors, please keep distance among indoor monitors to avoid affecting talk effect.



### (3) Monitor

For one outdoor camera or more outdoor cameras with one indoor monitor, if there is no calling from the outdoor camera, the indoor monitors are in standby mode. User can press the 🧑 button once to wake up the indoor monitor; press 🧑 button again to enter monitor mode and monitor the outdoor as long as you like, monitor signal will display on the screen. Press 🧑 button again to quit and turn off the screen.

For several outdoor cameras with one indoor monitor, in monitor mode, press 🧑 button to show the image from the CAM1, CAM2, CAM3, CAM4 (if the system has) in sequence. At the last outdoor camera, press 🧑 button again to quit and turn off the screen.

## (4) Charge

For the first time, the battery should be charged for more than 5 hours to activate the lithium battery. After that charge 3 hours every time, Charging led is red when charging, it turns green when the battery is filled, the color of battery bar will change from green to red when the battery is in low power.

## C Picture

### (1) Take pictures



When there is video from outdoor camera, presses  button to take a picture, one press captures one picture.

When the Call button of outdoor camera is pressed, if the user isn't in or no operation, all indoor monitors automatically save the image from camera after 10 seconds. The new picture will replace the first picture if no memory is available.

### (2) Browse pictures

In the non-talk mode, press ▲, ▼ button to browse the stored pictures, then press  button or after 10 seconds to quit browse mode.

### (3) Delete pictures

Firstly turn off the indoor monitor, then press  and  button together about 5seconds, then turn on the indoor monitor, until the screen displays text: 'Delete all photo, please wait' 'no photo , Please Power off'. After that all pictures have been deleted. Please turn off the indoor monitor.



## D Pair

**pair ok before use get the product.**

### 1 Pair outdoor camera with indoor monitor



**Note: The system only support 3 models as below. User can't mix them when purchase. For one-to-one system, adding more outdoor camera or more indoor monitor can't become one-to-multiple system.**

#### (1) One outdoor camera and one indoor monitor system is 1V1 system

Press 'pair' button of outdoor camera, indicating light flash, press  and  button of indoor monitor at the same time, the screen will show "... 1v1 pairing". If pairing succeeds, the video from outdoor camera will be shown in the screen of

indoor monitor.



#### (2) One outdoor camera and up to 4 indoor monitors system is 1VN system

Firstly, press 'pair' button of outdoor camera, indicating light flash, press  and  button of indoor monitor at the same time, the screen will show "... 1v4 pairing". If pairing succeeds, the video from outdoor camera will be shown in the screen of indoor monitor.

Secondly, repeat the above operation for each indoor monitor.

#### (3) Up to 4 outdoor cameras and one indoor monitor system is NV1 system

**Note: To pair this system is more complex than to do the above two systems. After turn on outdoor camera and indoor monitor, press button ASAP so not let any part enter into standby mode.**

Firstly, press the 'pair' button of outdoor camera, indicating light flash, press  and  button of indoor monitor at the same time, the screen will show "... 4v1 pairing", if pairing succeeds, the video will be shown in the screen of indoor monitor.

Secondly, repeat the above operation as soon as possible until finish all pairing. Thirdly, check whether pairing is successful, let system power on again, and then press 'monitor' button continuously to monitor each outdoor camera. If each outdoor camera works, it means that system pairs successfully. Otherwise repeat the first step.

### 2 Pair unlock control with door phone system

Unlock control is connected to 12V power adapter. Outdoor camera uses the battery, or is connected to the power adapter. Firstly press the pair button of unlock control, the pair light will flash once. Press the  button of the indoor monitor under talk mode, pair light will continuously flash.

Once again press the pair button of unlock control, pair light stops flashing.

Finally press the  button of the indoor monitor under talk mode, the pair light will flash 3 seconds, it means that pairing is successful.

### 3 Pair remote control with unlock control

Unlock control is connected to 12V power adapter. Firstly press the pair button of unlock control, pair light will flash once. Press the  button of remote control, pair light will continuously flash.

Once again press the pair button of unlock control, pair light will stop flashing.

Finally press the  button of remote control, the pair light will flash 3 seconds, it means that pairing is successful.

## 9. Working environment

(1) Working temperature: -15℃—+55℃ (2) Working humidity: ≤85%

## 10. Notices

(1) Please don't cover anything on the Microphone or speaker when it is in working mode.

(2) Please always use the specified power adapter, or that with the same model (same standard voltage and current).

(3) Do not attempt to service this product yourself as opening or removing covers may expose you to dangerous voltage or other hazards.

## 11. Specifications

Camera		Indoor monitor	
Light Source	6 LED lights	USB Power	Input: AC 100-240V 50/60Hz Output: DC 5V/1A
Camera	CMOS 300K pixels	Screen	3.5" TFT 320x240 7" TFT 800x480
Battery	BL-5J 1250mAh(option)	Battery	BL-5J 1250mAh
Power supply	Solar module, battery or 5V 1A power adapter	Power supply	Battery or 5V 1A power adapter
Size	126x93x42 mm	Size	3.5" 141x87x20 mm 7" 236x130x18 mm
Installation	Double-sided tape or screw fix	Installation	Place on the desk etc. Or wall mounting type
Standby	35 days	Standby	3.5" 20 days 7" 4 days

## 12. Failure diagnosis

Malfunction	Checking	Debug
Fail to start the product	If turn the switch to the "ON"?	Turn the switch to the ON
	If the power of Li-on battery is not enough?	Charge the Li-on battery
Fail to charge	If the plug of power adapter correctly?	Re-connect indoor monitor with power adapter
	If the power adapter correctly get through the 100-240V AC electricity?	Re-insert the plug to make power adapter get AC electricity.
No voice in talk mode	If the talk volume is adjusted to be the least?	To adjust the talk volume to be suitable.
The image is flashing or noisy	If the indoor monitor is close to induction cooker and microwave oven which has magnetic wave?	Keep indoor monitor far away from these things which has magnetic wave.
No signal for indoor monitor	If the outdoor camera doesn't connect the power?	To connect power adapter to the outdoor camera
	If the outdoor camera is far away from the indoor monitor?	Keep the distance in 60 meters within (stopped by multi-wall)
	If there is other strong magnetic space bother?	Keep indoor monitor far away from the strong magnetic space