



- Programmable channel generator with optional built-in GSM Modem
- Event and time based data logging functions for digital, analog and counter values
- Log Records are sent to the central Dupline-Online Webserver via GSM Modem or the Internet
- User access to real-time and historical Dupline-Online data via the Internet
- Export of files with logged data via the internet
- Real-time, timer and logic functions
- Analog set-point control and monitoring
- Light and Rollerblind control functions
- Alarm Monitoring
- Option for Radio controlled clock for high real time accuracy
- User-friendly configuration via Windows 98/2000/NT/XP software
- 2 x RS232 ports for configuration and Dupline data read/write
- 1 x RS485 port for networking of up to 32 Data Loggers
- Modbus-RTU protocol
- Built-in software driver for external radio modem
- 4 digital inputs / 4 digital outputs on-board
- H8-housing for DIN-rail mounting (EN50022)
- AC or DC power supply

Product Description

Programmable channel generator with built-in event and time based logging functions for digital, analog and counter values. Log Records can be sent to the central Dupline-Online Webserver via built-in GSM modem (optional) or the Internet. Users can access real-time and historical logged data via the Internet as alarm buffers, trend curves, bargraphs or as comma separated files. The Data Logger also contains intelligent functions for light and roller blind control,

alarm monitoring and analog set-point control. In addition to that, there is realtime, timer and logic functions. Programming is easily performed through Windows-based configuration software. Up to 32 Data Loggers can be networked as slaves in a RS485 network using the Modbus protocol. The unit has 4 digital inputs and 4 digital outputs onboard, and it is possible to create links to other Dupline networks via external Radio Modem.

Ordering Key

G 3800 1036 230

Type: Dupline®
H8-housing
GSM phone
Data Logger
Supply

Type Selection

Supply	Ordering no.	Ordering no. w. GSM telephone
115/230 VAC	G 3800 0036 230	G 3800 1036 230
10-30 VDC	G 3800 0036 800	G 3800 1036 800

Input/Output Specifications

Serial Port COM 1 COM 2	RS 232 115 kBaud 9600 Baud, adjustable	Sequence time 32 channels / 128 channels	38.6 ms / 132.3 ms
Data format COM 1, COM 2	8 bit No parity, 1 stop bit 9-pole female SUB-D	Digital outputs Function	4 PNP transistors Programmable
Pin assignment	TxD Pin 2 RxD Pin 3 GND Pin 5	Output voltage V _{DO}	≤ 35 VDC
Dielectric voltage Com.port - Dupline®	≥ 2 kVAC (rms)	Output current	≤ 100 mA
RS 485	Modbus-RTU	Output voltage drop	≤ 2 V
Termination	Pin 27 When in use, connect to pin 31	Off-state leakage current	≤ 100 µA
Fs-B	Pin 28 When in use, connect to pin 30	Short-circuit protection	None
Fs-A	Pin 29 When in use, connect to pin 31	Built-in protective diodes	None
+ (B)	Pin 30	Dielectric voltage	≥ 4 kVAC (rms)
- (A)	Pin 31	Output - Dupline®	200 V
GND	Pin 32	Output - Input	External noise suppression required
V+	Pin 33 ¹⁾	Inductive loads	
Protocol	Modbus-RTU	Inputs	
Dupline® Output	Dupline® carrier	Digital	6 - 30 VDC
Output voltage	8.2 V	Voltage	ON > 5.5 V; OFF < 1.5 V
Current	< 130 mA	Current	≤ 6 mA
Short-circuit protection	Yes	Dielectric voltage	≥ 4 kVAC
		Input - Dupline®	
		GSM Modem	
		Siemens cellular engine	TC35
		Dual Band	EGSM900 and GSM1800
		Output power	Class 4 (2 W) EGSM900 Class 1 (1 W) GSM1800
		Antenna connector	FME

¹⁾ V+ and GND may be used as supply for digital I/O's, if RS 485 is not used.

Supply Specifications

Power supply AC-Types	Overvoltage cat. III (IEC 60664)
Rated operational voltage through term. 21 & 24 jumper term. 22 & 23	230 VAC ± 15% (IEC 60038)
Power on term. 21 & 23	
Neutral on term. 22 & 24	115 VAC ± 15% (IEC 60038)
Frequency	45 to 65 Hz
Rated operational power	Typ. 7 VA/3 W
Power dissipation	
G38000036	≤ 6 W
G38001036	≤ 7 W
Rated impulse withstand voltage	230 V
	115 V
Dielectric voltage	
Supply - Dupline [®]	≥ 4 kVAC (rms)
Supply - Output	≥ 4 kVAC (rms)
Supply - Input	≥ 4 kVAC (rms)
Supply - Com. ports	≥ 4 kVAC (rms)
Heat dissipation	4 W

Power supply DC-Types	Overvoltage cat. III (IEC 60664)
Rated operational voltage through term. 21 & 22	10 to 30 VDC
DC supply terminal 24 and 25	- 50 Hz for synchronizing the clock - in case of voltage break (AC) the log will automatically update itself until 10 mSec before the loss of current
Reverse polarity protection	Yes
Rated operational power	6 W

Supply Specifications (cont.)

Power dissipation	
G38000036	≤ 6 W
G38001036	≤ 7 W
Inrush current	1 A
Rated impulse withstand volt.	800 V
Dielectric voltage	
Supply - Dupline [®]	500 V
Supply - Output	200 V

General Specifications

Real-time clock	
Accuracy	Better than ± 1 minute/month
Internal back-up time	Typ. 48 hours
Power ON delay	< 2.5 s
Indication for	
Supply ON	LED, green
ON Line	LED, yellow
COM 1	LED, red
COM 2	LED, red
RS 485	LED, red
GSM	LED, red
Environment	
Degree of protection	IP 20
Pollution degree	3 (IEC 60664)
Operating temperature	0° to +50°C (+32° to +122°F)
Storage temperature	-20° to +85°C (-4° to +185°F)
Humidity (non-condensing)	20 to 80% RH
Mechanical resistance	
Shock	15 G (11 ms)
Vibration	2 G (6 to 55 Hz)
Dimensions	
Material	(see "Technical Information")
Weight	H8-housing 640 g

Wiring Diagrams

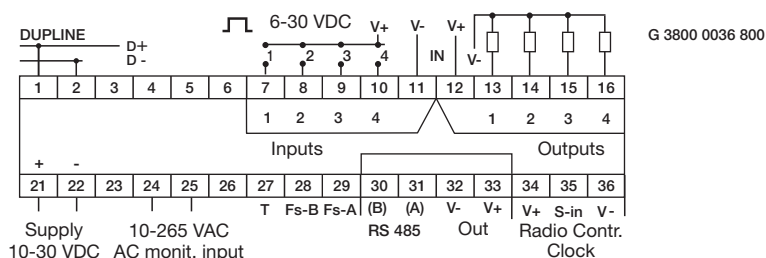
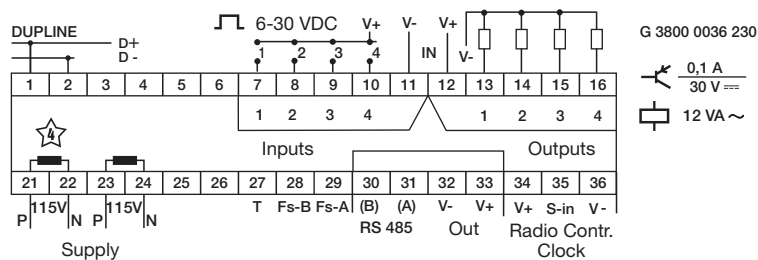

Mode of Operation

Logging functions to Dupline-Online

The G3800x036 Data Logger is a programmable channel generator, which can perform event and time based logging functions. Digital signals changing state and analog signals crossing a set-point are recorded as events, while analog signals and counter values are logged in regular user-defined time intervals. All Log Records include the address and description of the signal, and a time and date tag. Logged data are stored in non-volatile memory and are simultaneously sent to the central Dupline-Online Webserver via GSM modem or the Internet. Each Data Logger has its own unique ID-code that enables the central server to uniquely identify where a log record is coming from and thereby save it at the correct position in the database.

If Log Record transmission via the Internet is desired, an external pre-configured RS232-Ethernet converter is required (type ETHCONV1). A Data Logger using Internet transmission will continue to re-transmit the Log Record every minute over a 24 hour period until an acknowledge from the central server is received. The data telegrams are encrypted to ensure safe transmission via the Internet.

A Data Logger using GSM transmission will continue to re-send the Log Record as an SMS message until the GSM provider returns with an acknowledge that the SMS has been received. The central server is checking the telephone number of every received SMS data telegram to ensure safe transmission.

Users can access real-time and historical logged data via the Internet as alarm buffers, trend curves, bargraphs or as comma separated files. Since data is stored in a central server shared by multiple users with individual usernames and passwords allowing access to own data, there is no need to invest in new IT equipment. Any PC with an Internet connection and a standard browser can be used for data access. The central server is well-protected by a heavy-duty firewall and data back-up is performed on a daily basis to ensure data preservation.

Intelligent functions

The Data Logger is also equipped with intelligent functions for lighting control, roller blind control, temperature control and alarm monitoring. In addition to that the unit can be configured to perform real-time, logic and timer functions. The windows based configuration software is extremely easy to use due to the pre-programmed functions.

Data Logger configuration

The Data Logger is as default configured to operate as a standard channel generator without logging and intelligent functions. In order to make use of the intelligent functions the Data Logger must be configured by means of the user-friendly windows-based configuration software. This is included in the package and must be installed on a Win 95/98/2000/NT/XP PC. When the configuration is completed the configuration is downloaded into the Data Logger via COM1 (RS232 port). The configuration can be saved on a file and it is also possible to upload the configuration from a Data Logger.

In order to register the Data Logger for Dupline-Online operation on the Internet, it is necessary to upload to the Central Server a special configuration file created by the configuration software.

GSM Modem Option

The G38001036 Data Logger has a built-in GSM Modem which enables transmission of event and/or time based Log records to the Central server via SMS messages. Alternatively, the GSM modem can be used for monitoring and control of Dupline signals via SMS messages to/from mobile GSM telephones. There are 3 different ways to use SMS messaging:

- The Data Logger can be programmed to send out event based SMS messages. The event can be a channel switching ON or OFF, or it can be an analog signal crossing a setpoint.
- Requests for status of digital or analog data can be sent and answered via SMS messages
- Status of digital channels can be controlled by sending commands via SMS messages

In order to make use of the GSM modem, the following is required:

- A SIM-card with the pin-code 9090 needs to be inserted into the slot in the front of G38001036. The SIM-card must be a 3V type.
- A GSM antenna needs to be connected to the FME connector on G38001036. If the unit is installed in a metal enclosure, the antenna must be installed outside the enclosure and connected to the Data Logger via a cable (an antenna of this type is available as accessory).

An LED in the front of G38001036 indicates the status of the GSM modem. By emitting different blink patterns, the LED indicates "connecting", "SIMcard missing", "No network found", "No response from modem", "SMS sent" and "SMS received".

Radio Controlled Clock Option

It is possible to equip the G3800x036 with an external antenna for radio-controlled clock in order to achieve high timing accuracy in connection with real-time functions and event time stamps. When the antenna ANT2 is used, the G3800x036 will receive accurate timing signals from the DCF77 transmitter located in Frankfurt a.M., Germany. The antenna outputs the demodulated signals to the Data Logger via an open collector driver. The DCF77 transmitter covers all of Central Europe since the transmission radius is at least 1000 km. For longer distance the use of ANT2 depends on receiver conditions. ANT2 connects to the G3800x036 terminals.

RS232 ports

The Data Logger is equipped with two RS232 ports (COM1 and COM2) which both can be used by PC's/PLC's for read/write of Dupline data using the Modbus-RTU protocol. COM1 is also used for download and upload of configuration files (created by the Data Logger configuration software) and for firmware upgrades. If transmission of Log Records via the Internet is desired, the external RS232-Ethernet converter (ETHCONV1) needs to be connected to COM2. The same is the case if the option for an external radio modem is desired.

COM1 has a fixed baudrate of 115 kBaud, while the baudrate of COM2 is adjustable.

RS485 port

The RS485 port enables networking of up to 32 Data Loggers with or without automatic data exchange. This enables control and monitoring of up to 4096 data points. If desired, it is also possible to use Ethernet instead of RS485. In that case each Data Logger must be equipped with a converter. A Modbus Device Address needs to be assigned to each Data Logger during configuration. In a network with automatic data exchange, one Data Logger is configured as RS485 Master, and will thus synchronize a continual automatic data exchange between all the Data Loggers. When programming the individual Controllers it is then possible to make references to signals in other Dupline networks. For example the wind speed value measured by a sensor in one Dupline network, can be used in the roller blind control function in the other Dupline networks.

It is also possible to make e.g. "all lights OFF" functions for a big building by activating a single pushbutton. A PC or PLC, connected to one of the COM-ports of the G3800X036 operating as RS485 Master, gets access to all 4096 data points using the Modbus protocol. Also, using the PC makes it possible to change the configuration in any of the Data Loggers in the network.

In a network without automatic data exchange, a PC or PLC need to be RS485 Master and all the Data Loggers will operate as Modbus-RTU slaves. This makes it possible for the PC or PLC to read/write data from any of the 32 Data Loggers. See following RS485 networking diagram for both operating modes.

Modbus-RTU protocol

Using the Modbus-RTU commands 2 and 3 through COM1, COM2 or RS485 makes it possible to read any type of Dupline data (digital, analog, multiplexed analog or counter data). The status of digital and multiplexed analog data and reset of counter can be controlled via the commands 5, 6

and 16. See manual for memory map information.

Software

The Dupline Data Access software package (type no. DUP-DATACC) has been developed specifically for the Master Generator and the Data Logger. It contains two software tools that provide easy access from a PC to Dupline digital, analog and counter data via one of the RS232 or RS485 ports. The DDE-driver provides a Dynamic Data Exchange interface, which can be used from applications that support client side DDE such as Microsoft EXCEL. Getting Dupline data into an EXCEL spreadsheet is a simple copy-and-paste operation. The

Dupline ActiveX driver provides an ActiveX interface, which is a Microsoft standard for communication between two products. The Dupline ActiveX driver can be used from any development tool that supports client side ActiveX such as Microsoft Visual Basic, Delphi and Borland C++ builder. The Dupline Data Access package can be used on single Data Loggers as well as Data Logger networks.

Radio Modem driver

The Data Logger has a built-in driver for control of an external Radio Modem, which can be used to create wireless links where no cable is available in parts of an installation. One Data Logger just be defined as

the central Data Loggers and up to 32 Data Loggers can be defined as remote Data Loggers. The central Data Logger is continuously polling and updating the Dupline data from all remote Data Loggers via the radio modem network, and in this way it makes the entire system operate as one big Dupline network. Apart from increased reaction time (depending on the number of remote Data Loggers), the system will operate as if it was one Data Logger connected to all the I/O-modules with cable. The Data Logger supports the Radio Modem type 2ASxE and all 3AS types from the Finnish manufacturer SATEL (www.satel.fi). Find below an

application diagram for the Radio Modem option.

Note: Analink modules cannot be used with Radio Modems.

On-board I/O

The Data Logger has 4 digital inputs and 4 digital outputs on-board. These have been implemented to reduce the cost of remote stations with only a few signals (e.g. in connection with an SMS alarm system or radio modem remote stations). The onboard I/O's are used via the logic functions of the Data Logger, where they can be assigned to specific channel addresses.

Dupline-Online Principal Diagram

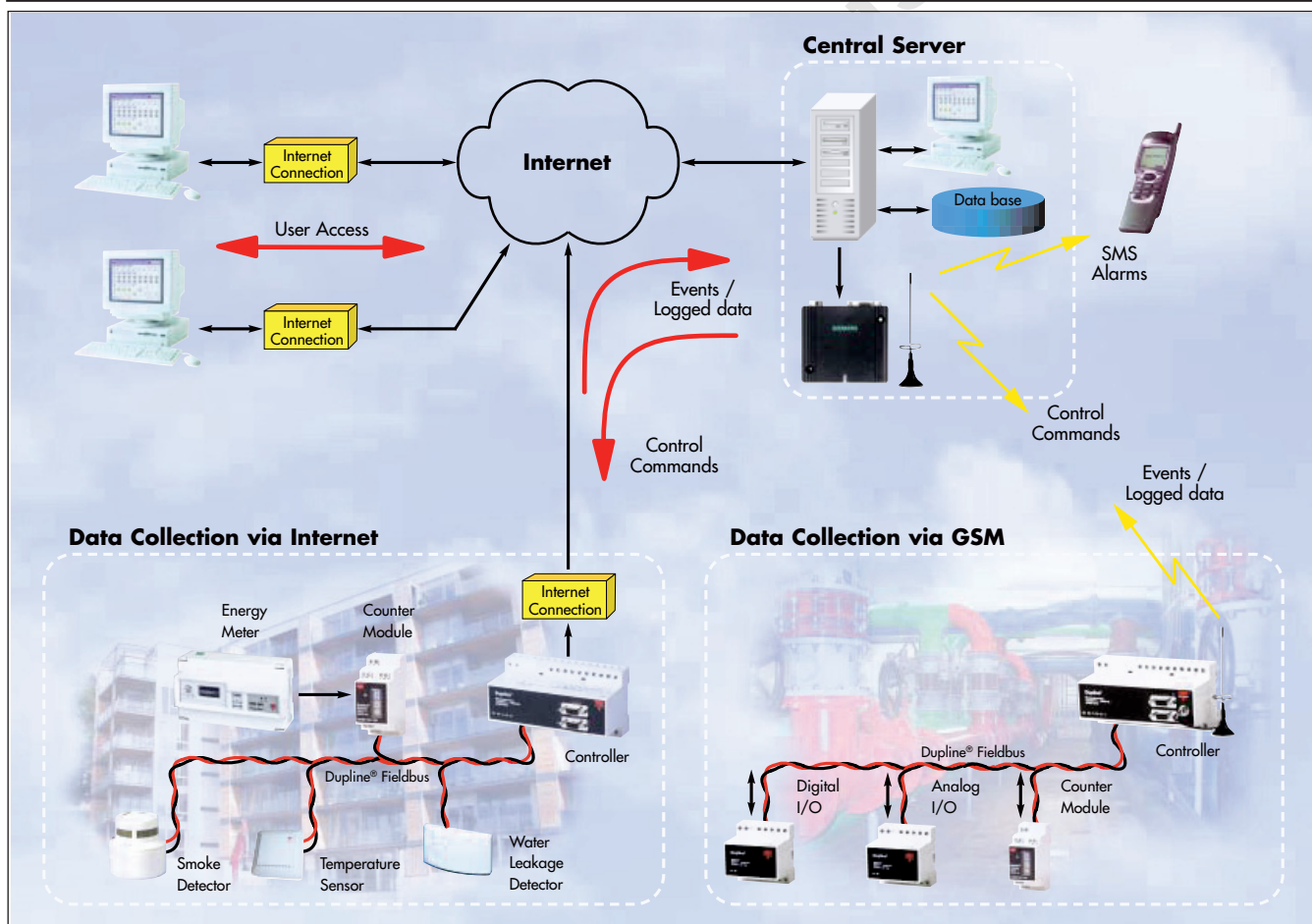

Pin Assignment, COM1, COM2

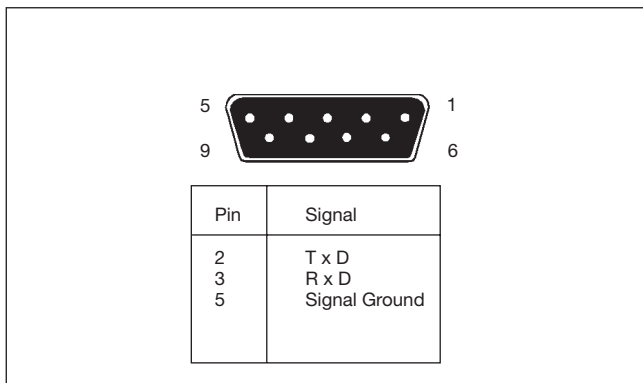

RS 232 Cable

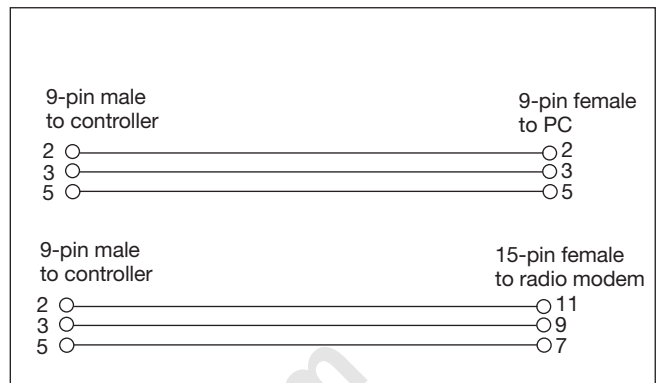

Radio Modem Application

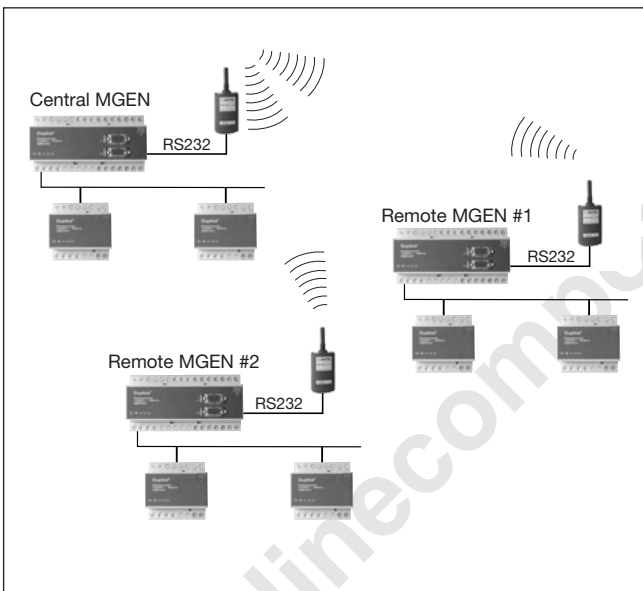

Dimensions (mm)

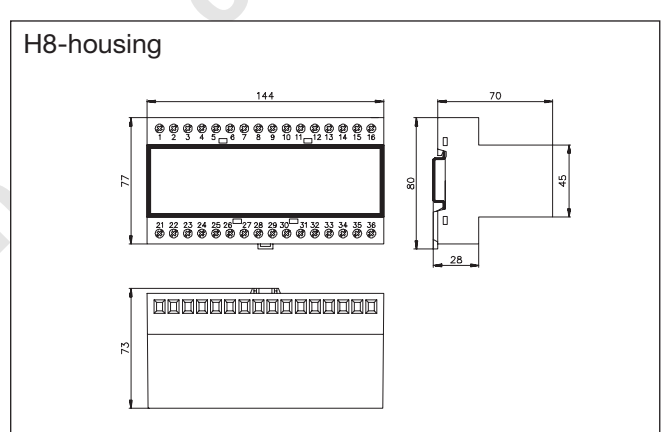

Scope of Supply

- 1 x Data Logger
- 1 x User manual
- 1 x RS 232 cable
- 1 x Configuration software

- G 3800 x036 xxx
- MAN G 3800 0036 ENG
- RS 232-9 M/9 F
- SW G 38xx36

Accessories

- RS232-Ethernet Converter
- Dupline Data Access Software
- GSM Antenna 900 MHz
- Antenna for Radio controlled clock
- ETHCONV1 (preconfigured)
- DUPDATAACC
- ANT1
- ANT2

