



USERS MANUAL / GEBRUIKERSHANDLEIDING / BETRIEBSANLEITUNG  
MODE D'EMPLOI / MANUAL DE UTILIZACION / ISTRUZIONI PER L'USO

# MASS SINE

## 12/800, 24/800 & 48/500

230V sine wave inverter



MASTERVOLT  
Snijdersbergweg 93,  
1105 AN Amsterdam  
The Netherlands  
Tel.: +31-20-3422100  
Fax.: +31-20-6971006  
[www.mastervolt.com](http://www.mastervolt.com)

ENGLISH:	PAGE 1
NEDERLANDS:	PAGINA 17
DEUTSCH:	SEITE 33
FRANÇAIS:	PAGINA 49
ESPAÑOL:	PÁGINA 65
ITALIANO:	PAGINA 81

v 4.1. February 2006

## CONTENTS:

<b>QUICK INSTALLATION INSTRUCTIONS</b> .....	<b>3</b>
<b>1 GENERAL INFORMATION</b> .....	<b>4</b>
1.1 Use of this manual .....	4
1.2 Guarantee specifications .....	4
1.3 Quality.....	4
1.4 Validity of this manual.....	4
1.5 Liability.....	4
1.6 Changes to the inverter .....	4
<b>2 SAFETY GUIDELINES AND MEASURES</b> .....	<b>5</b>
2.1 Warnings and symbols .....	5
2.2 Use for intended purpose .....	5
2.3 Organizational measures.....	5
2.4 Maintenance & repair.....	5
2.5 Warning for specific dangers .....	5
2.6 Warning regarding life support applications .....	5
<b>3 INSTALLATION</b> .....	<b>6</b>
3.1 Environment.....	6
3.2 Wiring.....	6
3.3 Unpacking.....	6
3.4 Tools required for installation .....	6
3.5 Mounting of the cabinet .....	7
3.6 Connecting.....	8
3.6.1 Removal of the front panel.....	8
3.6.2 Connecting the AC wiring and earth wiring.....	8
3.6.3 DC wiring.....	8
3.6.4 Battery cable connections .....	8
3.7 Connecting the remote control panel.....	9
3.8 Commissioning after installation.....	10
3.9 Automatic switching between AC sources.....	10
3.10 Decommissioning .....	10
3.11 Storage and transportation .....	10
3.12 Low energy mode .....	10
3.12.1 Low power mode.....	11
3.12.2 Economic mode.....	11
3.12.3 Stand-by mode.....	11
<b>4 OPERATION</b> .....	<b>12</b>
4.1 General .....	12
4.2 Switching on and off .....	12
4.3 Indicator lights on the front of the inverter .....	12
4.4 The remote control.....	13
4.5 Maintenance .....	13
<b>5 TROUBLE SHOOTING</b> .....	<b>14</b>
<b>6 TECHNICAL DATA</b> .....	<b>15</b>
<b>7 EC DECLARATION OF CONFIRMITY</b> .....	<b>16</b>

## QUICK INSTALLATION INSTRUCTIONS

**1**  This section provides a brief overview of a basic installation of the Mass Sine inverter.

However; please review the entire manual for connection of additional features and to ensure best performance and years of trouble-free service.

**2** The electrical system must be disconnected from any power source during the entire installation!  
Use isolated tools!



**3** Mount the inverter to a vertical surface. Allow at least 10 cm / 4 inch space around the apparatus!

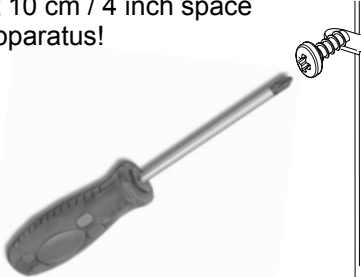

**4** Open the connection compartment; Steps:

- 1 Loosen the two Philips screws that secure the front cover plate for two turns.
- 2 Slide the front cover plate from the cabinet

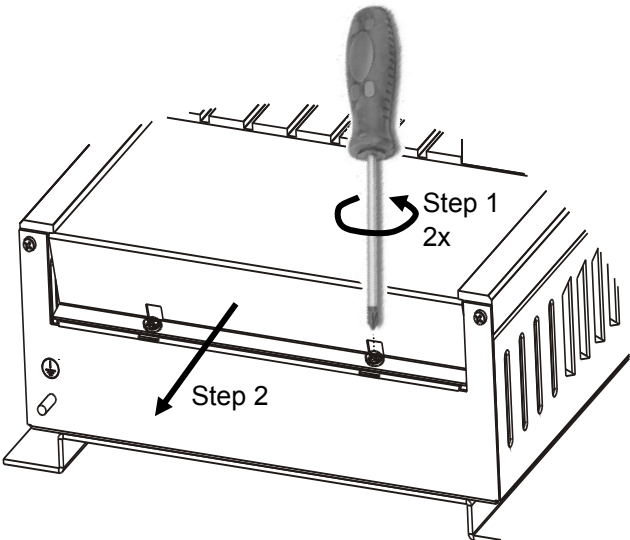

**5** Connect the AC load to the AC output.

For safe installation it is necessary to:

- Connect both the earth (PE/GND) and the neutral (N) of the AC output of the inverter to the central grounding point
- Integrate a Residual Current Device (RCD) in wiring of the AC output

Refer to local applicable regulations on these issues.

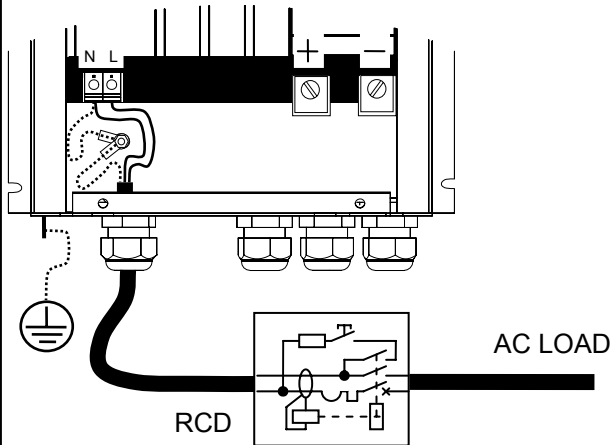

**6** Connect the battery to the DC input.

Integrate a fuse holder in the positive battery wire, but do not place the fuse yet.

Connect positive wire to +, negative wire to -.

Incorrect polarity will damage the inverter!

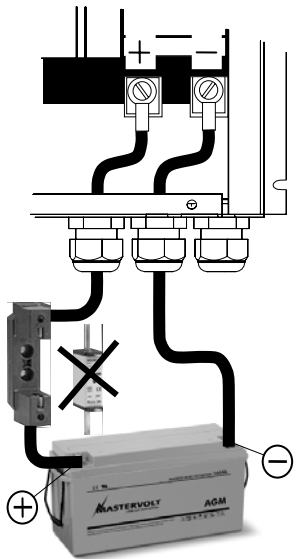

**7**

- Close the connection compartment.
- Place the inverter fuse.
- Switch on the inverter.



# 1 GENERAL INFORMATION

## 1.1 USE OF THIS MANUAL

This manual serves as a guideline for safe and effective operation, maintenance and possible correction of minor malfunctions of the inverter. It is therefore obligatory that every person who works on or with the inverter must be completely familiar with the contents of this manual, and that he/she carefully follows the instruction contained herein. Installation of, and work on the inverter, may be carried out only by qualified, authorized and trained personnel, familiar with the locally applicable standards and taking into consideration the safety guidelines and measures (chapter 2 of this manual).

Keep this manual at a secure place!

This manual has 16 pages.

## 1.2 GUARANTEE SPECIFICATIONS

Mastervolt guarantees that this unit has been built according to the legally applicable standards and specifications. Should work take place, which is not in accordance with the guidelines, instructions and specifications contained in this user's manual, then damage may occur and/or the unit may not fulfil its specifications. All of these matters may mean that the guarantee may become invalid.

## 1.3 QUALITY

During their production and prior to their delivery, all of our units are exhaustively tested and inspected. The guarantee period is two years after date of purchase.

## 1.4 VALIDITY OF THIS MANUAL

All of the specifications, provisions and instructions contained in this manual apply solely to the Mastervolt delivered standard versions of the MASS inverter. This manual is valid for the following models:

Description	Part number
MASS SINE 12/800	24010800
MASS SINE 24/800	24020800
MASS SINE 48/500	24040500

## 1.5 LIABILITY

Mastervolt can accept no liability for:

- consequential damage due to use of the inverter;
- possible errors in the manuals and the results thereof.



### CAREFUL!

Never remove the type number plate.

Important technical information required for service, maintenance & secondary delivery of parts can be derived from the type number plate.

## 1.6 CHANGES TO THE INVERTER

Modifications to the inverter may be carried out only after the written permission of Mastervolt.

## 2 SAFETY GUIDELINES AND MEASURES

### 2.1 WARNINGS AND SYMBOLS

Safety instructions & warnings are marked in this manual by the following symbols:



#### CAREFUL!

Special data, restrictions and rules with regard to preventing damage.



#### WARNING

A WARNING refers to possible injury to the user or significant material damage to the charger if the user does not (carefully) follow the procedures.

### 2.2 USE FOR INTENDED PURPOSE

- 1 The inverter is constructed as per the applicable safety-technical guidelines.
- 2 Use the inverter only:
  - in a technical correct condition;
  - in a closed, well-ventilated room, protected against rain, moisture, dust and non condensing circumstances;
  - observing the instructions in the user's manual



#### WARNING

Never use the inverter in situations where there is danger of gas- or dust explosion!.

- 3 Use other than as mentioned above is not considered to be consistent with the intended purpose. Mastervolt is not liable for any damage resulting from failure to comply with the above.

### 2.3 ORGANIZATIONAL MEASURES

The user must always:

- have access to the user's manual;
- be familiar with the contents of this manual. This applies in particular to chapter 2, Safety Guidelines and Measures.

### 2.4 MAINTENANCE & REPAIR

- 1 If the inverter is switched off during maintenance and/or repair activities, it should be secured against unexpected and unintentional switching on:

- switch off the connection with the batteries or remove the inverter fuse;
- be sure that third parties cannot reverse the measures taken.

- 2 If required, use only original spare parts. The inverter has no serviceable parts, except the fan and PCB.

### 2.5 WARNING FOR SPECIFIC DANGERS

- 1 Connect the earth of the inverter output to the central ground and use a Residual Current Device (RCD) in the inverter output.
- 2 Protect the DC wiring with a fuse, according to the guidelines in this user's manual.
- 3 Check the wiring at least once a year. Defects such as loose connections, heat damaged cables etc. must be corrected immediately.
- 4 Do not work on the inverter or the electrical system if it is still connected to a current source. Only allow changes in your electrical system to be carried out by qualified electricians.
- 5 Connection and protection must be done in accordance with local standards.
- 6 Before opening the cabinet of the inverter, switch off the mains and remove the inverter fuse.



#### WARNING

Setting the switch on the front of the inverter to 0 is not sufficient!

### 2.6 WARNING REGARDING LIFE SUPPORT APPLICATIONS

Mastervolt products are not sold for applications in any medical equipment intended for use as a component of any life support system unless a specific written agreement pertaining to such intended use is executed between the product manufacturer and Mastervolt. Such agreement will require the equipment manufacturer either to contract for additional reliability testing of the Mastervolt parts and/or to commit to undertake such testing as a part of the manufacturing process. In addition such manufacturer must agree to indemnify Mastervolt from any claims arising from the use of Mastervolt parts in the life support equipment.

### 3 INSTALLATION



#### WARNING

During installation and commissioning of the MASS inverter, the Safety Guidelines and Measures are applicable at all times. See chapter 2 of this manual.

#### 3.1 ENVIRONMENT

Install the MASS inverter in a dry, well ventilated, dust free situation. Locate the inverter as close as possible to the DC distribution in order to keep the battery cables short. Do not locate the inverter in the same compartment as the batteries. The heat of the inverter is discharged by a fan with a variable speed, from the bottom of the cabinet to the side.

When fitting the inverter be sure that:

- the air flow is not obstructed;
- the inverter is mounted vertically;
- no water and/or dust can enter the cabinet.



#### WARNING

Never use the inverter in locations where there is gas or explosion danger!

#### 3.2 WIRING

The way of wiring has influence on the EMC behaviour of the system in which the inverter is a component. This is caused by the fact that wires and cables are excellent reception and transmitter antennas of radio frequency electro magnetic interference. Most problems originate from mutual influencing of wires and cables.

Starting points for wiring with good EMC properties: Lay the cables in metal cable trunking. The metal of the trunking offers a low resistance to interference currents, so that these currents run in the trunking. The DC cables are to be in contact with one another, as far as possible. The cables of different groups should not be twisted, but run in parallel. If trunking is not possible, lay the cables parallel to a metal bar. If this is not possible, make a cable bunch in which the cables run in parallel.

#### 3.3 UNPACKING

In the box in which the inverter is delivered contains, in addition to the inverter this user's manual. After unpacking, check the inverter for possible damage. Do not use the inverter if the cabinet is damaged.



#### CAREFUL!

Never remove the type number plate!

Important technical data required for service, maintenance and later delivery of parts can be obtained from the type number plate (see fig. 1).

#### 3.4 TOOLS REQUIRED FOR INSTALLATION

We recommend as a minimum tool kit:

- Flat blade screw driver 0.6 x 3.5 mm to fix the screw terminals of the AC wiring.
- Flat blade screw driver 1 x 8 mm to fix the DC cabling.
- Tools to fix the screws / bolts (M5) with plugs to mount the cabinet to a surface
- Phillips screw driver nr. 2 to open the connection area of the inverter.

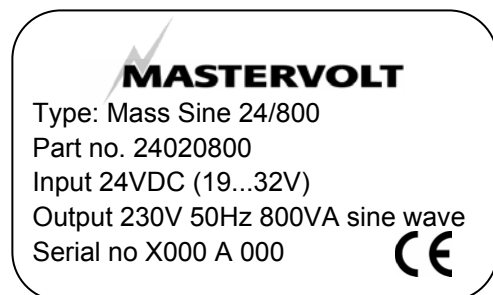

Fig 1: Type number plate MASS Sine

### 3.5 MOUNTING OF THE CABINET

Take the following steps to mount the cabinet (see fig. 2):

- 1 Determine the mounting points.
- 2 Drill mounting holes for the cabinet.
- 3 Mount the MASS inverter with four screws or bolts (M5) to the wall.
- 4 Fasten all screws or bolts securely.

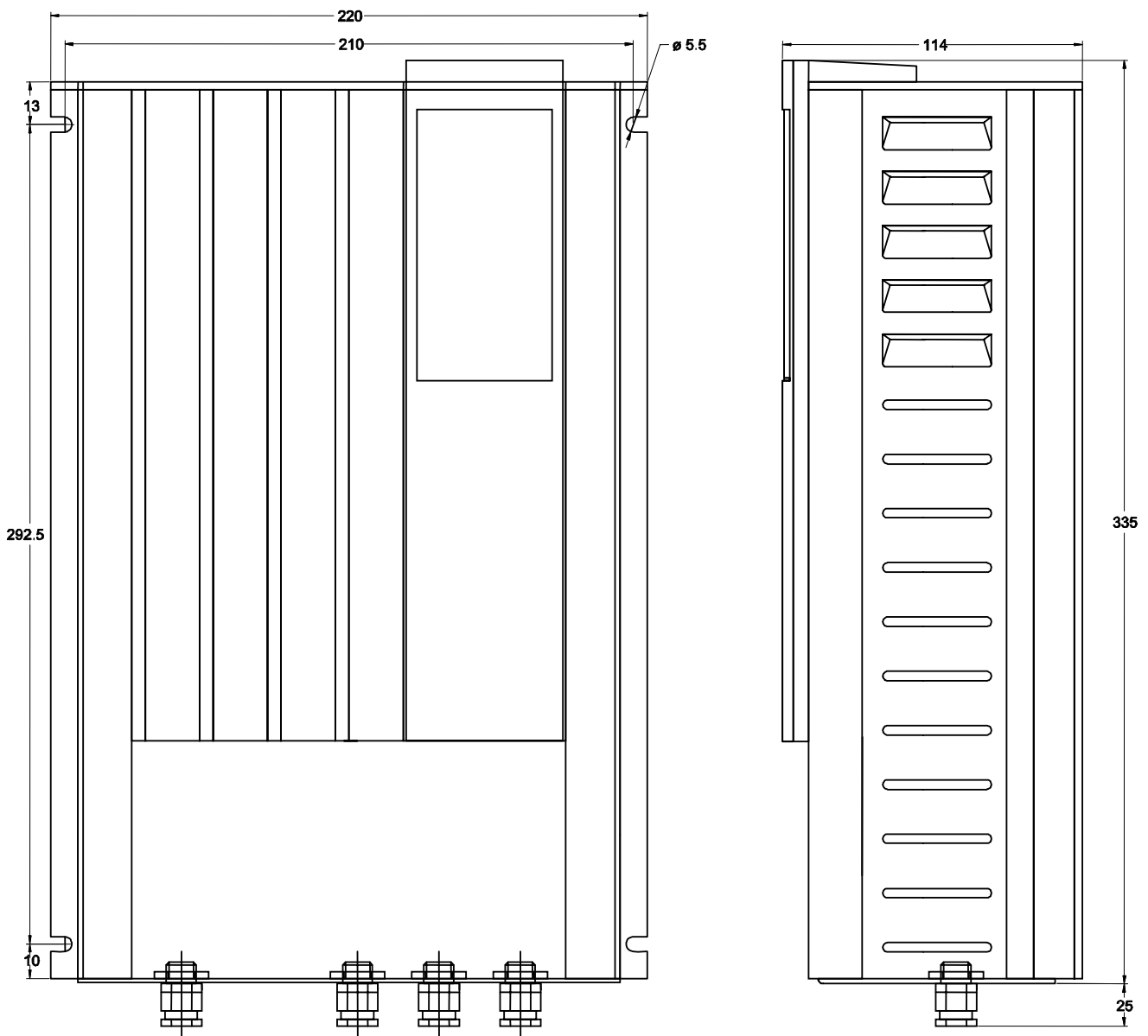

Fig. 2: Dimensions of the Mass Sine 12/800, 24/800 & 48/500

### 3.6 CONNECTING

Before beginning to connect the wiring, make the AC and DC distribution voltage-free.

#### 3.6.1 Removal of the front panel

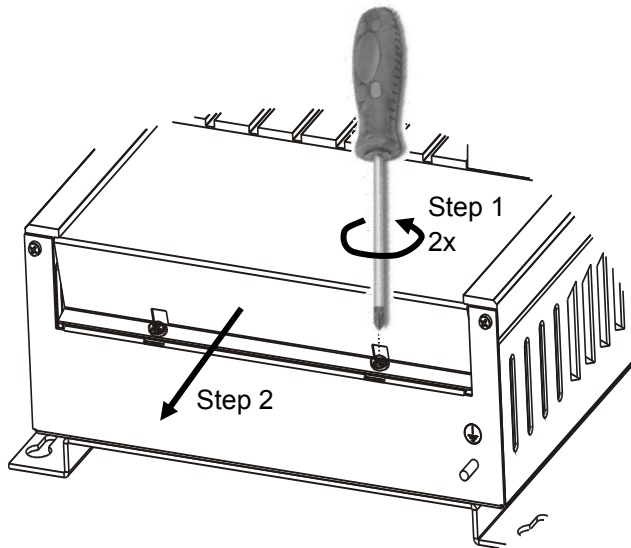

Figure 3

See figure 3. Steps:

- 1 Loosen the two Phillips screws that secure the front cover plate for two turns.
- 2 Slide the front cover plate from the cabinet (downwards).

The connectors for the battery, the AC and the remote panel are now visible.

#### 3.6.2 Connecting the AC wiring and earth wiring

General:

The inverter is protected against overload and short circuit, so it is not necessary to install a fuse in the output of the inverter.



**CAREFUL!**

For safe installation it is necessary to:

- connect the earth (PE) and neutral (N) of the inverter output to the central ground;
- insert a Residual Current Device (earth leakage switch) of 30mA in the inverter output.



**WARNING**

Check whether the voltage from the inverter is the same as the connected equipment.



**WARNING**

The earth wire offers protection only if the inverter cabinet is connected to the earth. Connect the inverter's earth terminal (at the right hand side of the AC terminal block) to the hull or chassis.

Move the on/off switch to the off position. On the left hand side is the connector for the AC wiring. Integrate a RCD (earth leakage) switch in the inverter output. Connect the AC on-board system brown wire to the terminal L, the bleu wire to the terminal N and the green/yellow earth wire to the terminal PE. Use 1.5 - 2.5 mm<sup>2</sup> wires.

#### 3.6.3 DC wiring

Keep the cable length as short as possible, this will keep the system efficiency as high as possible. The recommended minimum size of the battery cables is:

Inverter model:	12/800	24/800	48/500
Cable thickness	25 mm <sup>2</sup>	16 mm <sup>2</sup>	10 mm <sup>2</sup>
DC fuse	100A	63A	35A

The recommended length is a maximum of 6 meters. When longer cables are required, use thicker cables. When possible, use coloured (red and black) battery cables. If this is not possible, mark the cables with red and black isolation tape or heat shrink sleeve.

#### 3.6.4 Battery cable connections

The Mastervolt Service Centers have all accessories available, like battery terminals and supply cables in all sizes. Pull the battery cables through the glands at the bottom side of the inverter. Keep the cable connection between batteries and inverter as short as possible (maximum 6 meters). Connect the black negative battery cable to the negative connection bolt (right) and the red positive battery cable to the positive bolt (left) of the inverter. Cut the cables to the right length and fix, if necessary, connect cable clamps to both ends. Connect the negative cable to the negative battery pole and the positive cable via the inverter fuse to the positive red pole. See the connection diagram in fig. 4.





**CAREFUL!**

Reversing positive and negative will cause major damage to the inverter. This damage is not covered by the guarantee.



**CAREFUL!**

Too-thin cables and/or loose connections can cause dangerous overheating of the cables and/or terminals. Therefore tighten all connections well, in order to limit transition resistance as far as possible. Use DC cables of the correct size.

**3.7 CONNECTING THE REMOTE CONTROL PANEL**

See fig. 4. The remote control panel C4-RI for the MASS inverter comprises an off/on switch and two LEDs. The LED 'inverter on' indicates proper functioning of the inverter and the availability of 230VAC output voltage. The LED 'failure' indicates overload, over-temperature or low voltage. Connect the remote control panel by means of a modular communication cable; see figure 5 (not supplied with the panel).

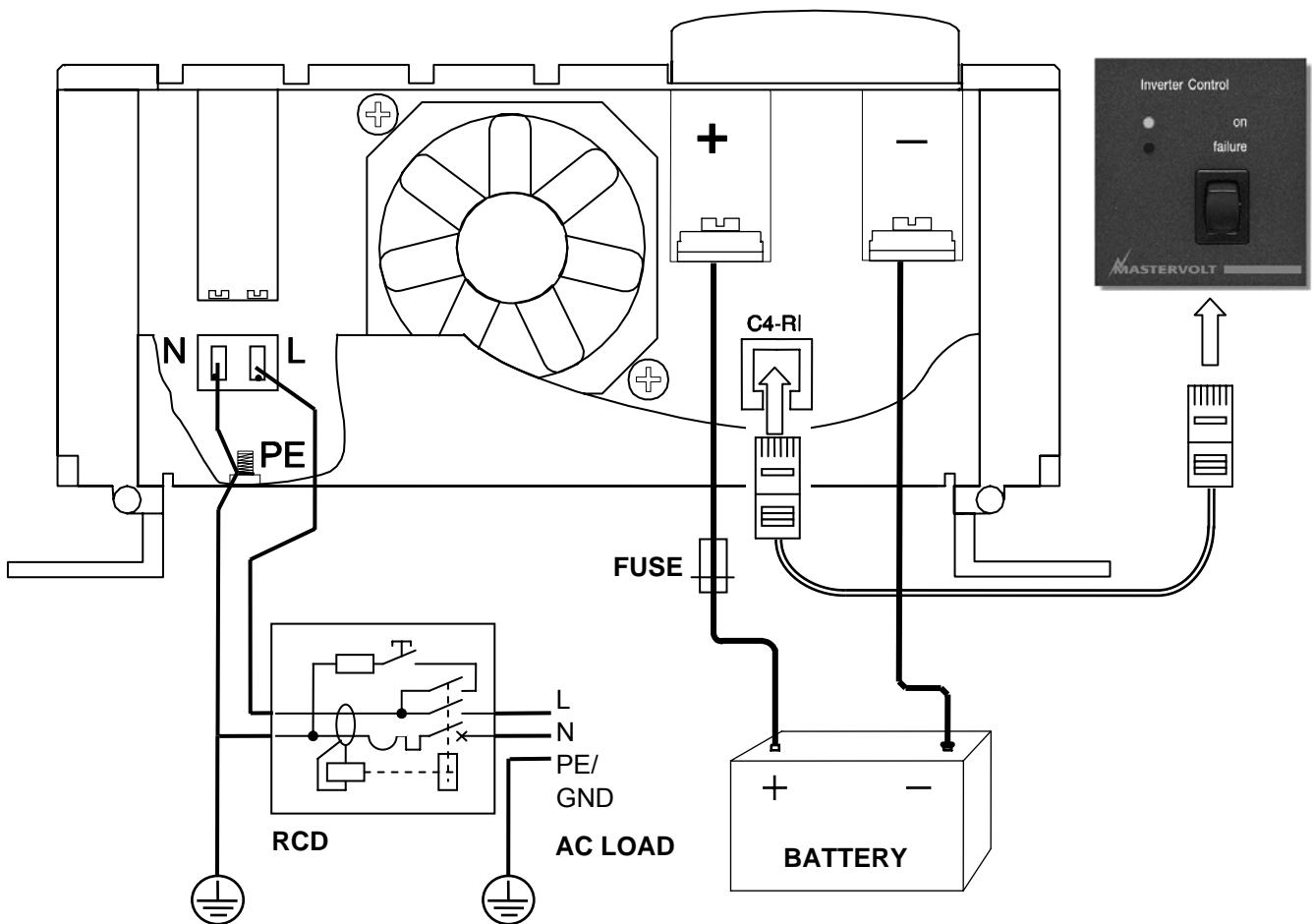

Fig. 4: connection of the Mass Sine 12/800, 24/800 and 48/500

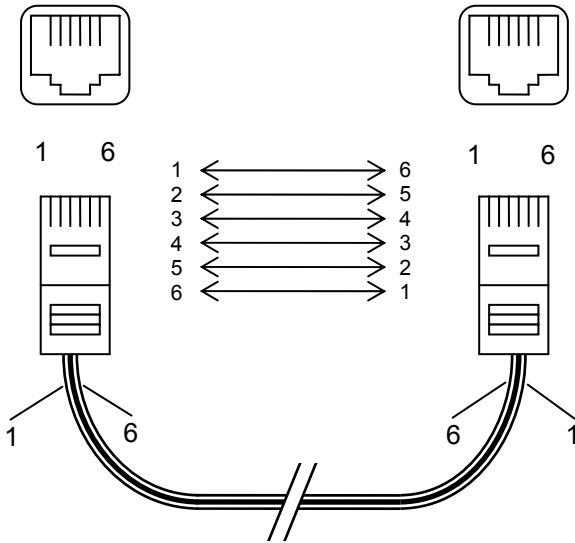

Fig. 5: Connection cable for panel C4-RI (not delivered as a standard)

### 3.8 COMMISSIONING AFTER INSTALLATION



**WARNING**

Remove the inverter fuse, if placed already.

- 1 Tighten all cable glands to ensure the pull relief
- 2 Carefully check the polarity of the connections.



**CAREFUL!**

Only insert the inverter fuse if the polarity is correct. Switching on with incorrect polarity will damage the inverter irreparably. The inverter fuse cannot prevent this.

- 3 If the connections are correct:
  - Close the front cover plate of the connection compartment
  - Check whether the on/off switch is in the "OFF" position;
  - Insert the inverter fuse. When inserting the inverter fuse, a spark will occur, caused by the capacitor used in the inverter. This is normal.

Now the inverter is ready for use.

### 3.9 AUTOMATIC SWITCHING BETWEEN AC SOURCES

Please contact your Mastervolt supplier if you intend to use the inverter with a generator set or shore power connection. Manually switching or simple relay switching systems could damage your inverter, because of the lack off time delay. This kind of damage is not covered by the warranty.

### 3.10 DECOMMISSIONING

Proceed as follows for decommissioning of the inverter:

- 1 Move the main switch to the OFF position.
- 2 Remove the DC fuse. Be sure that others can not reverse this action taken.
- 3 Now the inverter can be demounted in a safe way.

### 3.11 STORAGE AND TRANSPORTATION

When not installed, store the inverter in the original packing, in a dry and dust free environment.

Always use the original packing for transportation. Contact your local Mastervolt Service Centre for further details if you want to return the apparatus for repair.

### 3.12 LOW ENERGY MODE

For applications that request a very low energy mode, it is possible to set the inverter into "low energy mode". The "low energy mode" can be selected by placing a jumper (green) on the two metal pins on the top (left) corner of the PCB (see fig. 6).

To change the jumper settings, act as follows:

- Pull the inverter away from the wall.
- Loosen the four corner screws from the top cover.
- Remove the top cover from beneath the green plastic.
- The jumpers S1 and S2 are visible now.
- Set the jumpers to the desired state (see table 1).
- Place the top cover again and tighten the four corner screws.

**3.12.1 Low power mode**

In this mode the output voltage will drop to 208V if the connected load stays below 30W. The output voltage will be  $\pm 230V$  again if the connected load rises above 30W. Small loads like a digital clock will function properly and still 10% energy can be saved. The inverter can be set in this mode by placing jumper S2. Do not place jumper S1.

**3.12.2 Economic mode**

In this mode the output voltage will drop to 208V if the connected load stays below 250W. The output voltage will be  $\pm 230V$  again if the connected load rises above 250W. Most loads will function properly and still 10% energy can be saved. The inverter can be set in this mode by placing jumper S1. Do not place jumper S2.

**3.12.3 Stand-by mode**

The inverter has now been set to stand by mode, there will be no output voltage. The inverter checks if there is a load connected and will switch on when a load is detected. This mode will reduce the no load consumption with 90%. This mode is especially useful when mostly heavy loads are connected to the inverter. Loads with digital clocks can function irregularly, if this is the case set the inverter to economic or low power mode. The inverter can be set in this mode by placing jumper S1 and S2.

Table 1, jumper settings:

S1	S2	mode	output voltage
0	0	standard	230V
0	1	low power	208V < 30W
1	0	economic	208V < 250W
1	1	stand-by	0V, switches on in case of load

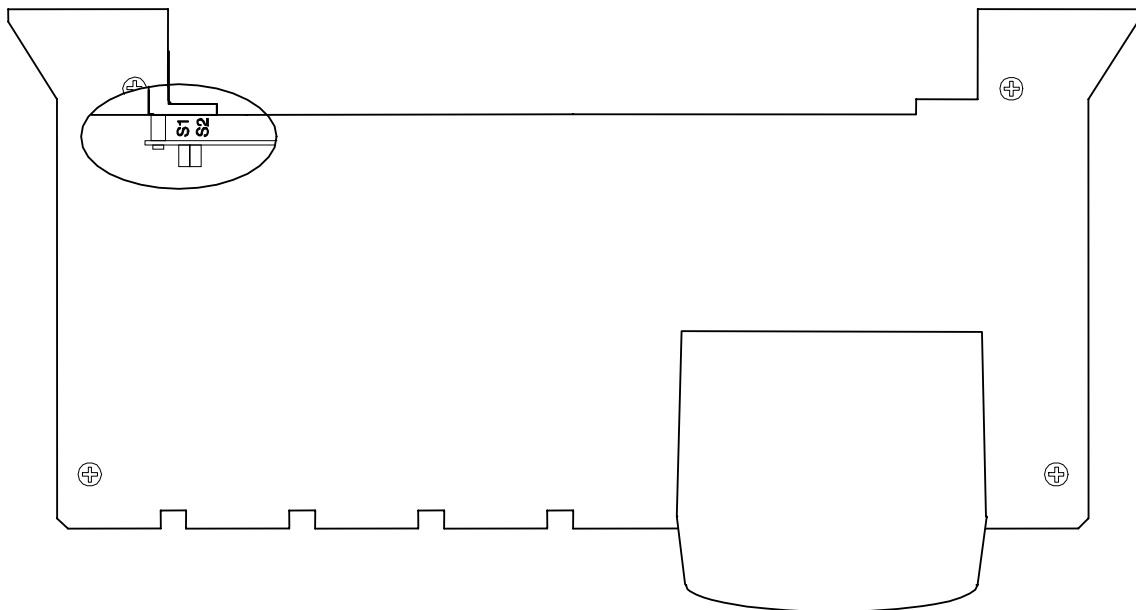

Fig. 6: Top view of the inverter and position of the jumpers

## 4 OPERATION

### 4.1 GENERAL

The MASS SINE inverter is a fully automatic high efficiency inverter, developed and produced by Mastervolt Amsterdam. The MASS SINE inverter is part of a series advanced quality battery chargers and inverters supplied by Mastervolt all over the world. The MASS SINE inverter converts a DC voltage to 230V AC, 50 Hz. The output voltage has a sinusoidal waveform for reliable and trouble free operation of connected equipment. The inverter is protected against overload, short circuit and over temperature. In case of overload, the inverter will reduce its output power. The MASS SINE inverter has a very high efficiency, due to the application of MOSFETS with high frequency switching technology.

### 4.2 SWITCHING ON AND OFF

**Switching on:** Move the on/off/remote switch on the front of the inverter to the "on" position. The green "inverter on" indicator illuminates and the inverter will start.

**Switching off:** Move the on/off/remote switch on front of the inverter to the "off" position. The inverter stops and all the indicators that are on, go off.



#### CAREFUL!

Switching off the inverter with the switch on the front does not break the connection to the batteries. The inverter remains connected to the batteries.

### 4.3 INDICATOR LIGHTS ON THE FRONT OF THE INVERTER

The functions of the indicator lights on the front are:

<b>inverter on:</b>	inverter is switched on
<b>overload:</b>	inverter is overloaded
<b>overload + inverter on 'blinking':</b>	overload in 'wait' state
<b>low battery:</b>	battery voltage is too low
<b>high temperature:</b>	inverter is overheated

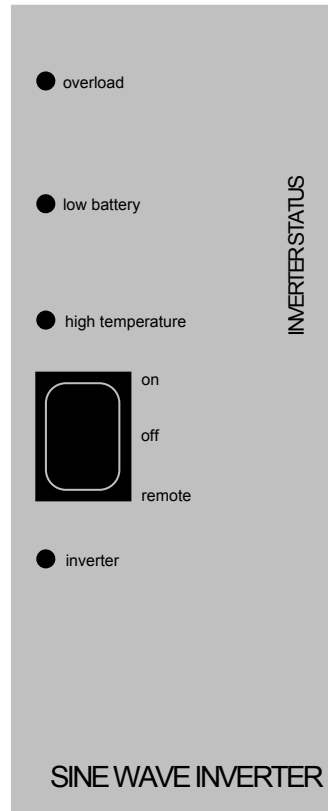

Fig. 7: Indicator lights of the inverter

Short description:

#### "inverter on"

The green light shows when the inverter is switched on.

#### "overload"

Glows if the inverter is overloaded. Depending on the load, the inverter will shut down after a short period.

#### "overload" + "inverter on"

The indicator lights "overload" and "inverter on" will flash in turn if the inverter has been switched off because of an overload condition. The inverter stays off for 1.5 min. Then the inverter will restart automatically. If the overload situation repeats itself 10 times within a period of 5 minutes, then the inverter will not restart automatically. Pressing the on/off switch will restart the inverter.

**“low battery”**

The inverter is switched off if the battery voltage is too low (see table hereunder). If the voltage rises above the values given below, the inverter restarts automatically.

model	12/800	24/800	48/500
Shut off voltage	10V	19V	36V
	±0.5V	±0.5V	±0.5V
Restart voltage	11V	22V	44V
	±0.5V	±0.5V	±0.5V

**“high temperature”**

The inverter switches off in case of high ambient temperatures and /or sustained overload. After cooling down, the inverter restarts automatically.

**4.4 THE REMOTE CONTROL**

If you use a remote control panel, the on/off/remote-switch on front of the inverter must be set to the ‘remote’ position. Move the on/off switch on the remote control panel to the ‘on’ position to switch on the inverter.

The meaning of the illuminated LED’s is:

<b>inverter on:</b>	inverter is switched on
<b>failure:</b>	inverter is overloaded, overheated or battery voltage is too low



Fig. 8: Remote control panel

If the failure LED is lit you can check the nature of the failure on the inverter front.

**4.5 MAINTENANCE**

For a reliable and optimum function of the inverter, the following is required:

- Check at least once a year if all cable and wire connections are still firmly connected.
- Keep the inverter dry, clean and dust-free, in order to ensure good heat discharge.
- Check the fan operation (has a life time of at least 10 years in normal use).

## 5 TROUBLE SHOOTING

Malfunction	Possible cause	What to do
No output voltage and no indication lights (LED's are off)	High battery voltage	Check battery voltage and switch charger off
	DC fuse blown	Replace the fuse.
	Switch set to remote, but no remote present	Put switch at on.
No output voltage, LED "low battery" is lit	Flat battery	Charge the batteries, the inverter will switch on if the battery voltage is above 11/22/24V.
No output voltage and LED "high temperature" is lit.	The inverter has been overloaded	Reduce the load and let the inverter cool off.
No output voltage and LED "inverter on" is lit	The inverter is in stand by mode	Connect a load or change the jumper settings.
Low output voltage	Low power mode = jumper setting	Connect a load > 40W or change jumper settings
	Economy mode = jumper setting	Connect a load > 250W or change jumper settings.
Inverter goes on and off, LED "inverter on" and LED "low battery" are blinking on turns	Flat battery	Disconnect load and charge batteries.
	DC cables too thin	Replace with cables of correct diameter.
	Connections are corroded or bad	Tighten the connections. If the cables are burned, replace them.
Inverter goes on and off, LED "inverter on" and "overload" blink in turns one time per second, ventilator is running at full speed	Inverter is overloaded	Reduce the load on the inverter
Inverter goes on and off, LED "inverter on" and "overload" blink in turns five times per second, ventilator is running at full speed.	Inverter has been switched off ten times as a result of an overload situation	Reduce the load. Reset the inverter manually by means of the on/off switch.

If you cannot correct a problem with the aid of the malfunction table, contact your Mastervolt Service Centre or Mastervolt Amsterdam for an extended service list, tel: INT+ 31-20-3422100.

### ORDERING INFORMATION

Part number	Description
70404110	Panel C-4-RI Remote control panel for Mastervolt inverters. Features: <ul style="list-style-type: none"> <li>• Remote operation of the inverter (on/of)</li> <li>• Status read-out: "power on" and "failure"</li> <li>• Dimensions: 60x65x60 mm</li> <li>• Mastervision compatible, Series size: 4</li> </ul>
6502001030	Modular communication cable, cross wired, 6 pole, 6 meter
6502100100	Modular communication cable, cross wired, 6 pole, 10 meter
124001000	Shorefix, RCD (residual current device) 16Amp/B/30mA in cabinet
6385401610	RCD (residual current device) for DIN rail mounting 16Amp/B/30mA, 1P+N

Mastervolt can offer a wide range of products for your electrical installation, including automatic AC transfer switches, remote control panels and shore cable connection sets

See our website [www.mastervolt.com](http://www.mastervolt.com) for an extensive overview of all our products

## 6 TECHNICAL DATA

Model	MASS SINE 12/800	MASS SINE 24/800	MASS SINE 48/500
Part number:	24010800	24020800	24040500
Function of the apparatus:	Conversion of a DC voltage to a pure AC sine wave voltage		
Manufacturer:	Mastervolt, Amsterdam, the Netherlands		

Input (DC)			
Nominal battery voltage:	12VDC	24VDC	48VDC
Under voltage shut down:	10V, $\pm 0.5V$	19V, $\pm 0.5V$	36V, $\pm 0.5V$
Under voltage restart:	11V, $\pm 0.5V$	22V, $\pm 0.5V$	44V, $\pm 0.5V$
Over voltage shut down:	15.5V, $\pm 0.5V$	31V, $\pm 0.5V$	62V, $\pm 0.5V$
Over voltage restart:	14.5V, $\pm 0.5V$	30V, $\pm 0.5V$	59V, $\pm 0.5V$
Maximum allowed ripple:	5% RMS	5% RMS	5% RMS
Current (nominal load)	68A	34A	12A
No load (off):	0 mA	0 mA	0 mA
No load (stand-by):	65mA/0.8W	35mA/0.8W	15mA/0.6W
No load (low power):	410mA/4.9W	200mA/4.9W	75mA/3.6W
No load (standard):	470mA/5.6W	240mA/5.6W	80mA/3.9W
Recommended DC fuse:	100A (slow blow)	63A (slow blow)	35A (slow blow)
Recommended DC cables:	25mm <sup>2</sup> / AWG 3	16mm <sup>2</sup> / AWG 5	10mm <sup>2</sup> / AWG 7
Minimum battery capacity:	100Ah	50Ah	25Ah

Output (AC)			
Output voltage:	230V ( $\pm 5\%$ )	230V ( $\pm 5\%$ )	230V ( $\pm 5\%$ )
Output waveform	True sine wave, THD: <5%		
Frequency:	50 Hz, $\pm 0.01\text{Hz}$	50 Hz, $\pm 0.01\text{Hz}$	50 Hz, $\pm 0.01\text{Hz}$
Nominal power ( $T_{\text{amb}}=40^{\circ}\text{C}$ ):	650VA @ $\cos \phi 1$	650VA @ $\cos \phi 1$	450VA @ $\cos \phi 1$
P30 power ( $T_{\text{amb}}=25^{\circ}\text{C}$ ):	800VA @ $\cos \phi 1$	800VA @ $\cos \phi 1$	500VA @ $\cos \phi 1$
Peak power:	1600VA	1600VA	1000VA
Cos phi:	All power factors allowed		
Maximum efficiency:	92%	92%	91%

Environment			
Operating temperature:	-25 to 40°C or -13 to 104°F, derating -3.3%/°C or -1.8%/°F above 25°C or 77°F		
Storage temperature:	-25 to 70°C or -13 to 158°F		
Cooling:	Temperature regulated fan		
Relative humidity:	< 95%, non-condensing		
Protection degree:	IP23		
Dimensions (H x W x D):	325 x 220 x 111 mm / 12.8 x 8.7 x 4.4 inch		
Weight:	3.9 kg / 8.6 Lbs	3.9 kg / 8.6 Lbs	3.9 kg / 8.6 Lbs

Miscellaneous	
Protections:	Overload, short circuit, over / under voltage, over temperature
Reversed polarity:	Reversed polarity may lead to permanent damage

Standards	
Emission	EN 55014-1:2000
Immunity	EN 55022:1998
Safety	EN 60950: 2000

## 7 EC DECLARATION OF CONFIRMITY

Manufacturer Mastervolt  
 Address Snijdersbergweg 93  
 1105 AN Amsterdam  
 The Netherlands



Herewith declares that:

Product: Mass Sine 12/800  
 Mass Sine 24/800

Is in conformity with the the following provisions of the EC:

EMC directive 89/336/EEC and amendments 92/31/EEC and 93/68/EEC.

The following harmonized standards have been applied: :

Generic emission standard	EN 55014-1:2000	Conducted Emission and click disturbances
Generic immunity standard	EN 55022:1998	Radiated Emission – Class B
	EN 61000-3-2:2000	Harmonic current emissions
	EN 61000-3-3:1995	Limitation of voltage fluctuations
	EN 61000-6-2:2001	Generic Industrial Immunity standard, from which
	EN 61000-4-2:1995	Electrostatic discharge (ESD) immunity
	EN 61000-4-3:2002	Radiated Electro-Magnetic field immunity
	EN 61000-4-4:1995	Electrical fast transient (EFT) immunity
	EN 61000-4-5:1995	Surge transient immunity
	EN 61000-4-6:1996	Conducted Radio-Frequency disturbances immunity
	EN 61000-4-8:1993	Power frequency magnetic field immunity
	EN 61000-4-11:1994	Immunity to voltage dips and short interrupts

Safety directive 72/23/EEC and amendment 93/68/EEC, with the following standard:

Low voltage directive EN60950: 2000

Amsterdam,



R.J. ter Heide,  
 General Manager MASTERVOLT

**MASTERVOLT**

Snijdersbergweg 93, 1105 AN Amsterdam, The Netherlands  
 Tel : + 31-20-3422100  
 Fax : + 31-20-6971006  
 Email : info@mastervolt.com