



## Operating Instructions

# CHARGER C650

Microprocessor controlled high performance rapid charger for LiPo battery packs with cell balancer.

**Charge current up to 8A, 100W, for 1-6 LiPo cells**



### Chargery Power Co., Ltd.

**Add:** Room 20B, Haihui Building, NanShan, ShenZhen, China

**Zip code:** 518054

**Tel:** +86 755 2643 6165

**Fax:** +86 755 2641 2865

**Email:** Jasonwang3a@163.com

**Web:** www.chargery.com

Welcome to the CHARGER CY-C650 intelligent charger designed especially for 1 to 6 LiPo cells. Please read the instructions carefully before using the charger.

## Special Features

### ■ Only for LiPo not lead acid battery and NIMH/NICd battery pack

It is super easy to operate the CY-C650. You need not choose and confirm the battery type; the battery chemistry is no opportunity to confuse you. What you do is to connect the charger to the battery pack and then to connect the DC power to the charger.

### ■ High power and intelligent circuit

The CY-C650 has a maximum output power of 100W with up to 90% power conversion efficiency. The unit can charge 1-6S LiPo cells at a maximum current of 8.0A. The automatic thermal management and efficient cooling system ensures that the charger can operate at full power without risk of overheating.

### ■ Dual confirmation for battery count in series

In addition to the user manually setting the cell count (displayed as "S"), the CY-C650 will identify the count automatically (displayed as "R"), and adjust the charging voltage and current automatically through comparing the "S" with "R".

### ■ Perfect safety design

#### Charging time limit

The charging time can be restrained; you can set it upon the battery status to prevent from any possible defect.

#### Battery temperature limit

The battery temperature will rise by its internal chemical reaction. If you set the limit of temperature, the charging process will be stopped forcibly when the temperature reach the limit.

#### Capacity charged limit

The capacity charged always calculated by multiple of the charge current and time. If the capacity charged reached the limit you set the charging will be terminated automatically.

#### Input power monitor

To protect the car battery using as input power from being damaged the input voltage always monitored. If it drops the lower limit the charging process will be ended automatically.

At the same time, when you use the AC adaptor or transformer as input power, if the input voltage is more than the limit the charging process will be terminated to protect the CY-C650 from being damaged.

### ■ Brightly back-light LCD screen

The clear back- light LCD shows pack voltage, charge current, charge time, capacity charged

### ■ Light and attractive AL alloy case

High-quality aluminum case is light and durable and very efficient to cool out the internal heat.

■ **Protection function**

- Reverse polarity and short circuit protection( input and output)
- Over charge and Over current protection
- Detect the over-discharged battery and pre-charge the battery at a small current to resume the battery capacity
- For the battery voltage is less than 2V/each cell, the CY-C650 will refuse to charge to prevent from happen safety accident.

**Program flow chart**

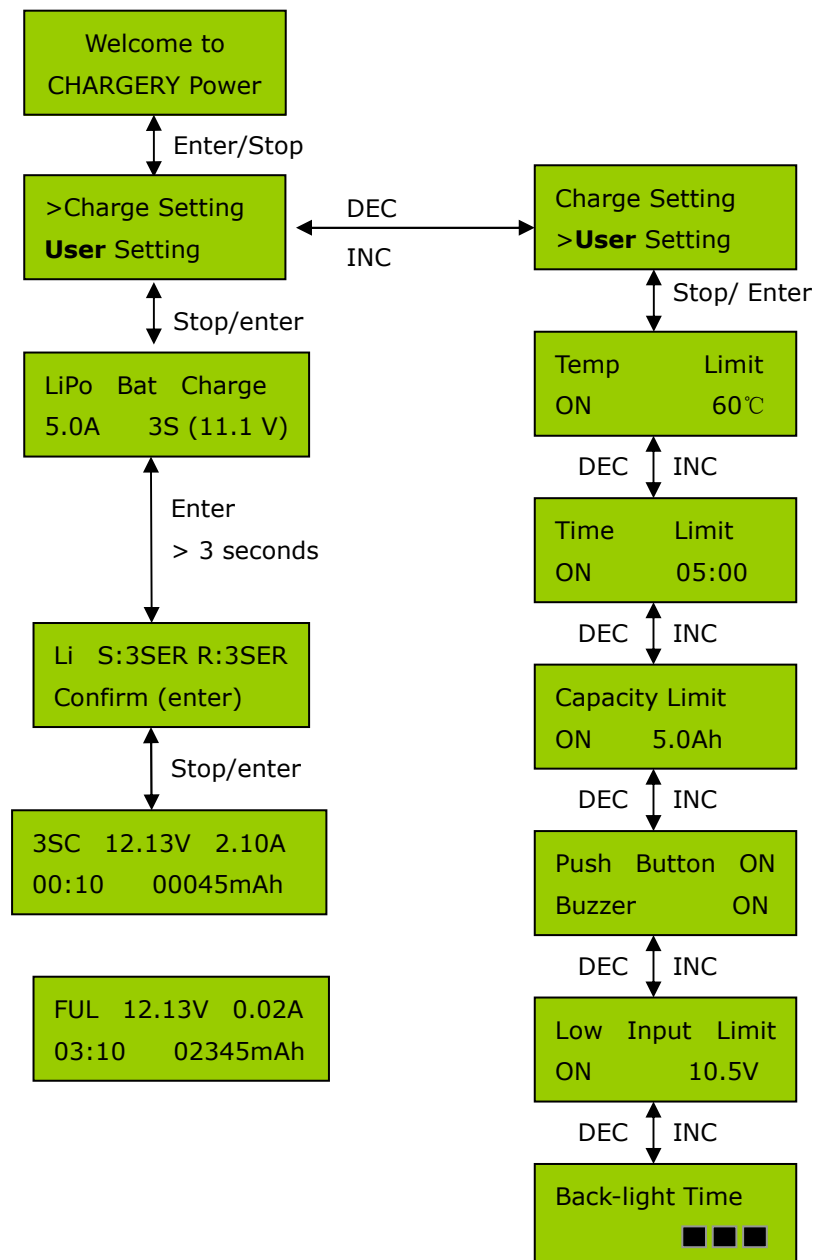

## Initial parameter set up

CY-C650 will be operated with the default value of the essential user settings when it is connected to a 12V lead acid battery or a 12V adapter for the first time. The LCD displays the following information in sequence and the user can change the value of parameter on each step. When you are willing to alter the parameter value in the program, press **START/ENTER** button to make it blink then change the value with **DEC** or **INC** button. The value will be stored by pressing **START/ENTER** button once.

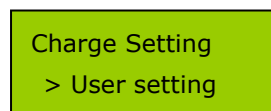

This is star screen.

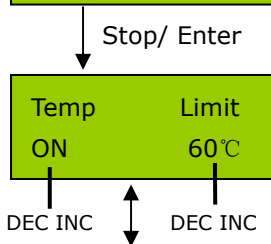

An optional feature using temperature probe contacts the surface of battery. The feature can be on or off. If it is on, set the maximal temperature at which the charger allows battery to reach during charge. Once the battery temperature reaches the limit while charge, the charging will be ended to protect the battery

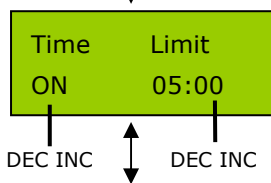

When you start a charge process, the integral safety timer automatically starts running at the same time. This is programmed to prevent overcharge the battery if it proves to be faulty or if the termination circuit can not detect the battery full charged. The value should be generous enough to allow a full charge of the battery. The time format is hh:mm.

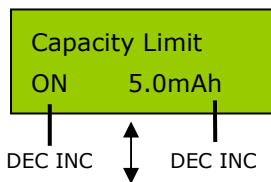

The program sets the maximal charge capacity that will be supplied to the battery during charge. If the termination circuit can not detect the battery full charged, this feature will automatically stop charging at the set capacity value.

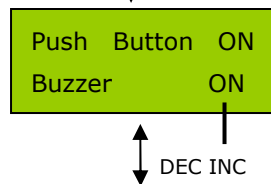

The beep sounds at every time pressing the buttons to confirm your action. The beep or melody sounded at various times during operation to alert different mode changes. These audible sounds can be on or off.

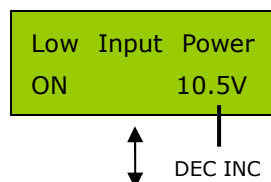

The program monitors the voltage of battery used as input power. If the voltage drops below the value you set, the charging process will be terminated forcibly to protect the battery.

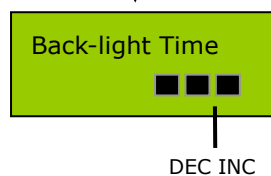

You can adjust the time of LCD light on

## Lithium polymer battery charging mode

These programs are only suitable for charging LiPo batteries with a nominal voltage of 3.7V/cell. The type of battery need to be charged at constant current (CC) and constant voltage(CV) mode. The charge current is dependent on the battery capacity, generally the charge current is less than 1C (the C is battery capacity, for example, if the capacity is 1000mAH, the charge current is less than 1000mA). The terminal voltage of full charged is very important, it should be 4.2V/cell for the nominal battery of 3.7V/cell, if the voltage exceeds 4.2V, the battery will explode during charge. The charge current and nominal voltage as for cell count set on the charge program must always be correct for the battery to be charged.

You should connect the battery power leads to the output of charger at this program. When you want to alter the parameter value in the program, press **STATR/ENTER** button to make it blink then change the value with DEC or INC. The value will be stored by pressing **STATR/ENTER** button once again.

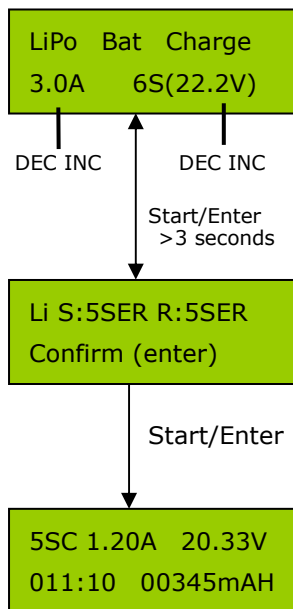

The value on the second line sets a charge current and the voltage of the battery pack. Press the **STATR/ENTER** button, and then press the **DEC or INC** to set value. After setting the current and voltage press **STATR/ENTER** button for more than 3 seconds to start the process. (Charge current: **0.1~8.0A**, Voltage: 1~6 series)

The left screen shows the battery count, 'S' is the result set up by you at the previous screen and 'R' shows the battery count detected by the CY-C650. You can start charging by pressing **STATR/ENTER** button. Or press **STOP** button to go back to previous screen. Then carefully check the battery nominal voltage or battery count to set again.

The screen shows the present situation during charge process. **"5S"** means the battery pack charged is 5 cells in series even the cell count you selected is not 5. The **"C"** indicates "Charge", the **"P"** indicates "Pre-charge", On the top line it means battery count, charging current and battery voltage from left to right. While for the bottom line, it means charging time and capacity charged.

To change the charge current, press **STATR/ENTER** button. Decrease or increase the current by pressing the **DEC or INC** button.

To stop the charge, press **STOP** button.

You can also check the parameters you set up on the USER SETTING by pressing **INC or DEC** button; include Input voltage limit, Battery temperature Limit, and the real battery temperature.

## Warning and error messages





CY-C650 designed a various protection and alarm functions to monitor the operation of charger. In any case of occurring error, the LCD will display the possible cause.

Battery Over-discharge	Battery voltage is lower than 2.8V, or the battery voltage is not over 3V, 6V, 9V, 12V, 15V, 18V after pre-charging.
Battery Voltage High	Battery voltage is over 25.2V
Short circuit	The battery connect reversely, or the DC out leads short-circuit
Connection Break	This will be displayed in case of detecting an interruption of the connection between battery and output
Low Input Power	The voltage of input power lowers the limit.
Battery Temp. High	The battery temperature rose over the limit.
Capacity Charged High	The capacity charged reached the limit.
Charging Time High	The charging time reached the limit.

### Specifications

- Applied battery type: LiPo battery
- LiPo battery count: 1~ 6 series
- Input voltage: DC 11-18V, 12A
- Circuit power: MAX. 100W
- Charge current:0.1~8A
- Dimensions:126\*78\*28mm
- Weight:350g

### Accessories

<b>CW1:</b> Input and Output leads, 4mm gold banana to alligator clips		<b>CW9:</b> temperature sensor
		
<b>CW5:</b> Output, 4mm gold banana to JST	<b>CW3:</b> Output, 4mm gold banana to Deans	<b>CW4:</b> Output, 4mm gold banana to Tamiya
		

### Warnings and safety information

- Never leave the charger unattended when it is connected to its power supply. If any malfunction is observed immediately terminated charging and refer to the operation instructions.
- Keep away the unit from dust , damp, rain, heat direct sunshine and vibration. Do not drop it.
- The charger and the battery to be charged should be set up on a head-resistant, non-inflammable and non-conductive surface. Never place them on a car seat, carpet or similar.

- Keep all the inflammable volatile materials well away from operating area.
- Be sure to understand the information of the battery to be charged accurately. If the battery count is set up incorrectly the battery can severely be damaged, even cause a fire or an explosion by over-charged.
- Do not connect more than one battery pack to the charger output lead at any time.
- Do not attempt to charge the following types of battery:
  - Lead acid battery or VRLA
  - NIMH/NICd battery pack.
  - Any other types of battery except for li-ion and lithium polymer battery.
  - Battery pack, which consists of different types of cell (including different manufacturers).
  - Battery, which is already fully charged or just slightly discharged.
  - Non-rechargeable batteries (Explosion hazard).
  - Faulty or damaged battery.
  - Batteries with unconfirmed charging current
- Please bear in mind of checking the following point before charge operation.
  - Did you select the appropriate program, which are suitable for the type of battery?
  - Did you set up adequate current for charging?
- Lithium battery pack can be composed with parallel and series circuits mixed. You have to [check the composition of the battery pack carefully before charging](#).
  - Are all connection firm and safe, or is there an intermittent contact at any point in the circuit?

Those warnings and safety notes are particularly important. Please follow the instructions for a maximum safety; otherwise the charger and the battery can be damaged. And also it can cause a fire to injure a human body or to lose the property.

### Warranty and Service

Chargery Power Co., Ltd. as manufacture of R/C model power warrants its CHARGER charger and battery pack to be free of defects in material and workmanship. This warranty is effective for 18 months from date of purchase. If within the warranty period the customer is not satisfied with the products performance resulting from a manufacturing defect the accessory will be replaced or repaired. This warranty does not cover the damage due to wear, overloading, incompetent handling or using of incorrect accessories.