

Before operating this unit, please read this manual thoroughly and retain it for future reference.

User's Manual

GKB D341 Series IP Camera

HD IR dome
Network Camera (Brilliant IR)



Making Security Easier.

GKB 

About this Manual

This user manual is for use with the GKB D341 Series IP Camera. This document contains important information and instructions detailing proper operation and maintenance of GKB D341 Series IP Camera. Installation instructions for these cameras are provided separately in the Installation Guide.

Be aware that GKBD341 Series IP Camera must be installed and used in accordance with the instructions given in this manual. Before installing or operating the unit, please read all safety notes and warnings provided in this manual.

GKB D341 Series IP Camera is a surveillance device for use in security systems that assist in the management of security. GKB is not liable nor can be held responsible for any material loss and/or personal injuries cause by robbery, fire, natural disaster or problems of any kind resulting from the use of this device.



Do not dispose this camera as general waste. This product must be treated as a recyclable product. Contact your local government recycling program or the supplier of the product to confirm the proper method of disposal.

Warning and Precaution

This information is provided to ensure your safety and to prevent loss either physical or financial. Read carefully before using the product. Read all sections of this manual where the following marks are shown.



Ignoring this may result in material loss and/or serious personal injury including death.



Ignoring this may result in material loss and/or slight personal injuries.



Do not disassemble.

Precaution



1. Do not drop the camera.

GKB DZ Series IP Camera is not designed to resist heavy impact. Handle with care to avoid damage to sensitive internal components.



2. Do not expose the camera to radioactivity and mount facing strong light sources.

Exposing the camera to radioactivity or strong light over long periods of time will damage the camera's sensor.



3. Do not supply voltage higher than GKB DZ Series regulated voltage.

Before supplying power to your camera, please make sure the power supply voltage is supported by your camera.



4. Do not install the camera under unstable light conditions.

Installing GKB DZ Series in environments with unstable light conditions may cause the camera to function abnormally.

Package Content



Dome Camera X 1

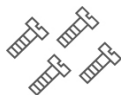

Accessory Pack X 1

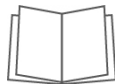

User's Manual X 1

Dimensions (Unit: mm)

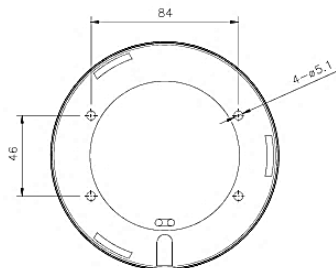
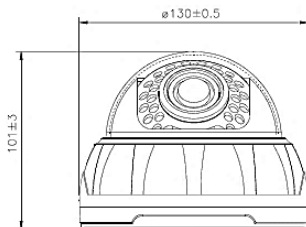
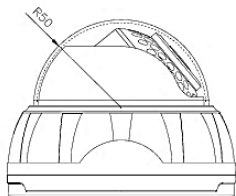

Features

GKB D341 Series

- CMOS Megapixel Sensor
- H.264 Video Compression
- Cloud Platform service
- 8 video streams
- Brilliant IR
- 2 way audio
- DI / DO

Software

- GKB_Loader includes Cam_setup, NVR10, Viewer11.
http://www.gkbsecurity.com/software/GKB_Loader_Package.zip
- Cloud-NVR : <http://www.cloud-nvr.com>

Specification

Model No.		GKBD34124	GKB D34131	
Video	Resolution	720P(1280*720),VGA,QVGA	1080P(1920*1080),VGA,QVGA	
	Frame Rate	Up to 720P, 30 fps	Up to 1080P, 25 fps	
	Video Compression	H.264		
	Video Streams	8		
Camera	Image Sensor	1/4" CMOS HD Sensor	1/2.5" CMOS HD Sensor	
	Lens	2.8~12mm lens		
	Min. Illumination	0.1 Lux (color mode)		
	Infrared Distance	20 meters; Brilliant IR		
	Infrared Quantity	30 pcs		
	Night Mode	Auto		
	White Balance	AWB		
	BLC	Yes		
	Shutter Control	1/10~1/10,000 sec Electronic rolling shutter(ERS)		
	Scanning System	Progressive		
	Gamma	0.45		
	S/N Ratio	>44 dB		
	General	Power Supply	12V DC / PoE (IEEE 802.3af)	
		Power Consumption	<7W	
Audio compression		GSM		
Storage		MicroSD Card up to 32GB (Enable Remote Site Playback)		
DI / DO		DI : 12V~24V DC DO : 30V DC-1A or 125V AC-0.5A		
Connector		RJ-45 x 1 Audio In x 1 Audio Out x 1 DI x 1 DO x 1 Composite Video Output x 1		
Dimension		101(H)x 130(Ø) mm		
Operating Temperature		-20 °C ~ 60 °C		
Weight		400 g		
Networking		Protocol	HTTP,TCP,UDP,DNS,DHCP,PPPoE, Samba,RTP,RTCP,RTSP	
	Ethernet	10/100Mbps Fast Ethernet RJ-45 port		
Software	Operating System	Windows XP and above		
	Software Package	NVR-10: 64 Channel NVR	Viewer-11	
		Cloud-NVR http://www.cloud-nvr.com	Setup Software Utility	

How to install GKB D341 Series?

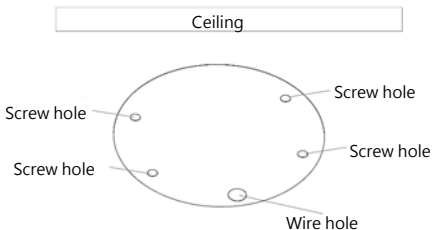

1. Put the installation sticker onto ceiling → Drill holes

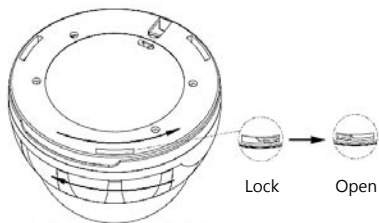

2. Turn the bottom cover clockwise and take off the upper cover

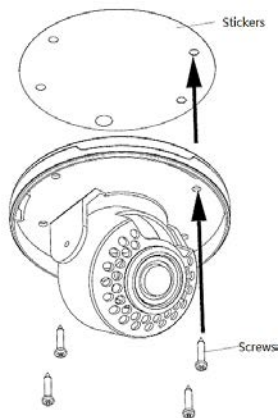

3. Lock 4 screws and fix camera onto ceiling

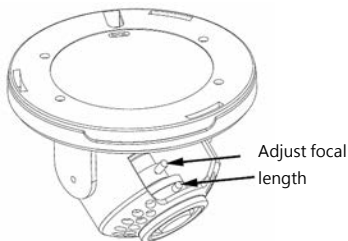

4. Adjust focal length and vertical/horizontal shooting angle

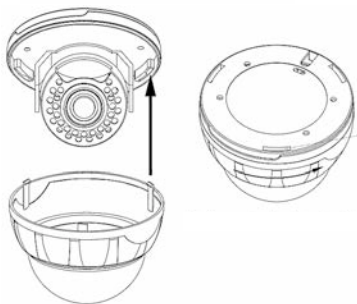

5. Put the cover back and turn clockwise to lock

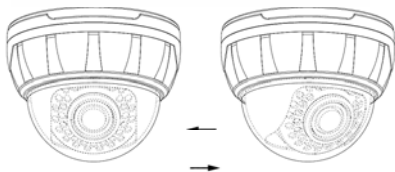

6. For minor adjustment, turn the outer cover, the inner black cover and lens would be turned as well

Warranty Policy

For detailed information on product warranties and warranty claim, please contact your local GKB distributor or agent.