



User's Guide

artec500 active series



Antes de utilizar el equipo, lea la sección "Precauciones de seguridad" de este manual. Conserve este manual para futuras consultas.

Before operating the device, please read the "Safety precautions" section of this manual. Retain this manual for future reference.

CONTENTS

SAFETY PRECAUTIONS	3
WARRANTY	4
DECLARATION OF CONFORMITY	5
INTRODUCTION	6 a 7
CONFIGURATIONS	8 a 11
<u>4x artec506A + 1x artecS15A</u>	
<u>4x artec508A + 2x artecS15A</u>	
<u>4x artec510A + 2x artecS15A</u>	
<u>4x artec526A + 2x artecS15A</u>	
LINE DRAWINGS	12
SPECIFICATIONS	13
AMPLIFIER	14 a 16
<u>Description</u>	
<u>ON / OFF</u>	
<u>Overload indicators</u>	
<u>Equalisation</u>	
<u>Overheating</u>	
<u>Low mains voltage</u>	
<u>Current consumption</u>	
<u>Troubleshooting</u>	
ACCESSORIES	17
APPENDIX	18
<u>Line connections: unbalanced and balanced</u>	



Cajas acústicas activas / Self-powered loudspeaker enclosures

El signo de exclamación dentro de un triángulo indica la existencia de importantes instrucciones de operación y mantenimiento en la documentación que acompaña al producto. Conserve y lea todas estas instrucciones. Siga las advertencias. ATENCIÓN: Es un producto clase A, por lo que en entornos domésticos puede causar radio-interferencias, en cuyo caso el usuario tendrá que tomar las medidas oportunas. De acuerdo con EN55103-2, usar el equipo sólo en entornos E1, E2, E3 ó E4.



No desconecte la tierra en el conector de alimentación pues es peligroso e ilegal. Equipo de Clase I.

El signo del rayo con la punta de flecha, alerta contra la presencia de voltajes peligrosos no aislados. Para reducir el riesgo de choque eléctrico, no retire la cubierta.



Sólo use este equipo con el cable de red de alimentación adecuado para su país.

No instale el aparato cerca de ninguna fuente de calor como radiadores, estufas u otros aparatos que produzcan calor. Debe instalarse siempre sin bloquear la libre circulación de aire por las aletas del radiador.

Si los altavoces se utilizan al aire libre en un día soleado, colocar los altavoces en un área sombreada o a cubierto. Los amplificadores de los altavoces tienen circuitos de protección que silenciarán temporalmente el altavoz cuando las temperaturas que se alcanzan sean extremadamente altas. Esto puede suceder en los días calurosos cuando el altavoz esté expuesto a la luz solar directa.

No exponga este equipo a la lluvia o humedad. No use este aparato cerca del agua (piscinas y fuentes, por ejemplo). No exponga el equipo a salpicaduras ni coloque sobre él objetos que contengan líquidos, tales como vasos y botellas. Equipo IP-20.

Este símbolo indica que el presente producto no puede ser tratado como residuo doméstico normal, sino que debe entregarse en el correspondiente punto de recogida de equipos eléctricos y electrónicos.



Equipo diseñado para funcionar entre 15°C y 42°C con una humedad relativa máxima del 95%, con un rango de $\pm 10\%$ de la tensión nominal de alimentación indicada en la etiqueta trasera (según IEC 60065:2001). Si debe sustituir el fusible preste atención al tipo y rango.

El cableado exterior conectado al equipo requiere de su instalación por una persona instruida o el uso de cables flexibles ya preparados.

Si el aparato es conectado permanentemente, la instalación eléctrica del edificio debe incorporar un interruptor multipolar con separación de contacto de al menos 3mm en cada polo.

Desconecte este aparato durante tormentas eléctricas, terremotos o cuando no se vaya a emplear durante largos periodos.

No emplace altavoces en proximidad a equipos sensibles a campos magnéticos, tales como monitores de televisión o material magnético de almacenamiento de datos.



Para las cajas con vaso para trípode, la altura máxima de seguridad desde el suelo a la base de la caja montada sobre trípode modelo TRD-2, con pies a 55 cm del eje del trípode, es:

- artec 506A -----> 135 cm
- artec 526A -----> 130 cm
- artec 508A -----> 135 cm
- artec 510A -----> 125 cm

El colgado del equipo sólo debe realizarse utilizando los herrajes de colgado recomendados y por personal cualificado. No cuelgue la caja de las asas.

No existen partes ajustables por el usuario en el interior de este equipo. Cualquier operación de mantenimiento o reparación debe ser realizada por personal cualificado. Es necesario el servicio técnico cuando el equipo se haya dañado de alguna forma, como que haya caído líquido o algún objeto en el interior del aparato, haya sido expuesto a lluvia o humedad, no funcione correctamente, haya recibido un golpe o su cable de red esté dañado.

Limpie con un paño seco. No use limpiadores con disolventes.

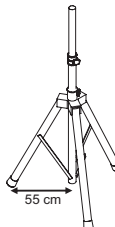

The exclamation point inside an equilateral triangle is intend to alert the users to the presence of important operating and maintenance (servicing) instructions in the literature accompanying the product. Heed all warnings. Follow all instructions. Keep these instructions.

WARNING: This is a class A product. In a domestic environment this product may cause radio interferences in which case the user may be required to take adequate measures.

Use this product only in E1, E2, E3 or E4 environments according to EN55103-2.

Do not remove mains connector ground, it is dangerous and illegal. Class I device.

The lightning and arrowhead symbol warns about the presence of uninsulated dangerous voltage. To reduce the risk of electric shock, do not remove the cover.

Only use this equipment with an appropriate mains cord for your country.

Do not install near any heat sources such as radiators, heat registers, stoves or other apparatus that produce heat. The circulation of air through the heatsink must not be blocked.

If loudspeakers are used outdoors on a sunny day, place the loudspeakers in a shaded or covered area. The loudspeaker amplifiers have protection circuits that temporarily shut the loudspeaker off when extremely high temperatures are reached. This can happen on hot days when the loudspeaker is in direct sunlight.

Do not expose this device to rain or moisture. Do not use this apparatus near water (for example, swimming pools and fountains). Do not place any objects containing liquids, such as bottles or glasses, on the top of the unit. Do not splash liquids on the unit. IP-20 equipment.

This symbol on the product indicates that this product should not be treated as household waste. Instead it shall be handed over to the applicable collection point for the recycling of electrical and electronic equipment.

Working temperature ranges from 15°C to 42°C with a relative humidity of 95%, with $\pm 10\%$ of the rated main voltage value indicated on the rear label (according to IEC 60065:2001). If the fuse needs to be replaced, please pay attention to correct type and ratings.

The outer wiring connected to the device requires installation by an instructed person or the use of a flexible cable already prepared.

If the apparatus is connected permanently, the electrical system of the building must incorporate a multipolar switch with a separation of contact of at least 3mm in each pole.

Unplug this apparatus during lightning storms, earthquakes or when unused for long periods of time.

Do not place loudspeakers in proximity to devices sensitive to magnetic fields such as television monitors or data storage magnetic material.

For enclosures with tripod socket, the maximum safety height from floor to bottom of enclosure when mounting on a TRD-2 tripod, with legs spread 55cm from the central pole, is:

- artec 506A -----> 135 cm
- artec 526A -----> 130 cm
- artec 508A -----> 135 cm
- artec 510A -----> 125 cm

The appliance should be flown only from the rigging points and by qualified personnel. Do not suspend the box from the handles.

No user serviceable parts inside. Refer all servicing to qualified service personnel. Servicing is required when the apparatus has been damaged in any way, such as power-supply cord or plug is damaged, liquid has been spilled or objects have fallen into the apparatus, the apparatus has been exposed to rain or moisture, does not operate normally or has been dropped.

Clean only with a dry cloth. Do not use any solvent based cleaners.

GARANTÍA

Todos nuestros productos están garantizados por un periodo de 24 meses desde la fecha de compra.

Las garantías sólo serán válidas si son por un defecto de fabricación y en ningún caso por un uso incorrecto del producto.

Las reparaciones en garantía pueden ser realizadas, exclusivamente, por el fabricante o el servicio de asistencia técnica autorizado.

Otros cargos como portes y seguros, son a cargo del comprador en todos los casos.

Para solicitar reparación en garantía es imprescindible que el producto no haya sido previamente manipulado e incluir una fotocopia de la factura de compra.

WARRANTY

All D.A.S. products are warrantied against any manufacturing defect for a period of 2 years from date of purchase.

The warranty excludes damage from incorrect use of the product.

All warranty repairs must be exclusively undertaken by the factory or any of its authorised service centers.

To claim a warranty repair, do not open or intend to repair the product.

Return the damaged unit, at shippers risk and freight prepaid, to the nearest service center with a copy of the purchase invoice.



DECLARACIÓN DE CONFORMIDAD DECLARATION OF CONFORMITY

D.A.S. Audio, S.A.

C/ Islas Baleares, 24 - 46988 - Pol. Fuente del Jarro - Valencia. España (Spain).

Declara que la *serie artec 500*:

Declares that *artec 500 series*:

Cumple con los objetivos esenciales de las Directivas:

Abide by essential objectives relating Directives:

- Directiva de Baja Tensión (Low Voltage Directive) 2006/95/CE
- Directiva de Compatibilidad Electromagnética (EMC) 2004/108/CE
- Directiva RoHS 2011/65/UE
- Directiva RAEE (WEEE) 2012/19/UE

Y es conforme a las siguientes Normas Armonizadas Europeas:

In accordance with Harmonized European Norms:

- EN 60065:2002+A1:2006 +A11:2008+A2:2010 +A12:2011
Audio, video and similar electronic apparatus. Safety requirements.
- EN 55103-1:2009
Electromagnetic compatibility. Product family standard for audio, video, audio-visual and entertainment lighting control apparatus for professional use. Part 1:Emission.
- EN 55103-2:2009
Electromagnetic compatibility. Product family standard for audio, video, audio-visual and entertainment lighting control apparatus for professional use. Part 2:Immunity.

INTRODUCCIÓN

The new *artec 500 series* are designed for fixed and portable applications. With a wide range of accessories for truss, wall, ceiling and rigging mounting, the new *artec 500 series* is a great option from a portable installation to the most elegant nightclub.

Características

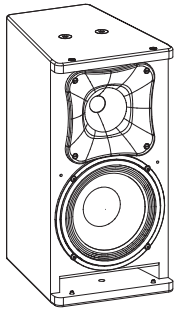

artec 506A

- Ultra lightweight Class D amplifier
- Switch-mode power supply
- Reduced size and weight
- Horizontal or vertical position
- Wall mount accessories
- Pole mount accessories

The *artec 506A* incorporates a single 6" loudspeaker for low frequency reproduction. The 720 W peak power of the Class D amplifier provides extended bandwidth, improved dynamic range and exceptionally low distortion-features hard to find on other systems in this market segment. The D.A.S. 6p loudspeaker provides accurate low frequency reproduction. High frequencies are handled by the M-34 compression driver with 1" exit offering excellent HF performance. The birch plywood cabinet construction offers an ultra-compact design which is available in black or white.

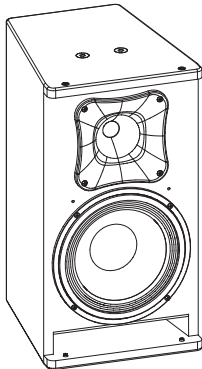

artec 508A

- Ultra lightweight Class D amplifier
- Switch-mode power supply
- Reduced size and weight
- Horizontal or vertical position
- Wall mount accessories
- Pole mount socket

The *artec 508A* incorporates a single 8" loudspeaker for low frequency reproduction. The 720 W peak power of the Class D amplifier provides extended bandwidth, improved dynamic range and exceptionally low distortion-features hard to find on other systems in this market segment. The D.A.S. 8C loudspeaker provides accurate low frequency reproduction. High frequencies are handled by M-34 compression driver with 1" exit offering excellent HF performance. The birch plywood cabinet construction offers an ultra-compact design which is available in black or white.

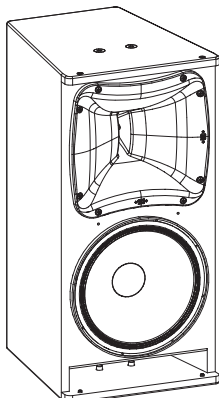

artec 510A

- Ultra lightweight Class D amplifier
- Switch-mode power supply
- Reduced size and weight
- Wall mount accessories
- Pole mount socket

The *artec 510A* incorporates a single 10" loudspeaker for low frequency reproduction. The 720 W peak power of the Class D amplifier provides extended bandwidth, improved dynamic range and exceptionally low distortion-features hard to find on other systems in this market segment. The D.A.S. 10p loudspeaker provides accurate low frequency reproduction. High frequencies are handled by the M-60N compression driver with 1" exit and titanium diaphragm offering excellent performance. The birch plywood cabinet construction offers an ultra-compact design which is available in black or white.

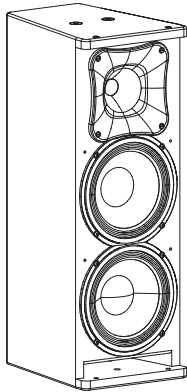

artec 526A

- Ultra lightweight Class D amplifier
- Switch-mode power supply
- Reduced size and weight
- Horizontal or vertical position
- Pole mount accessories

The **artec 526A** incorporates twin 6" loudspeakers for low frequency reproduction, The 720 W peak power of the Class D amplifier provides extended bandwidth, improved dynamic range and exceptionally low distortion-features hard to find on other systems in this market segment. The D.A.S. 6p loudspeakers provide accurate low frequency reproduction. High frequencies are handled by the M-34 compression driver with 1" exit construction offers an ultra-compact design which is available in black or white.

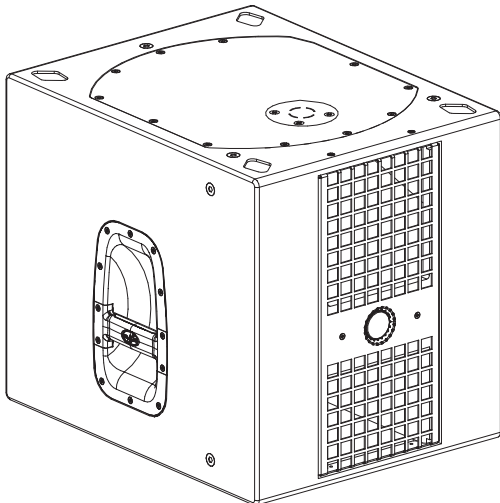

artec S15A

- Powered subwoofer system
- High output 15" loudspeaker
- Loop Thru connections
- Filtered output defeat switch
- Variable LPF range 100-138 Hz

The **artec S15A** is a powered subwoofer system designed to provide extended bass response for the **artec** full-range cabinets. A 2000 W peak Class D amplifier drives a D.A.S. 15SX bass loudspeaker. The 15SX loudspeaker incorporates a 4" voice coil for high power handling and output. The subwoofer system includes two balanced inputs with stereo filtered output connections for **artec** satellite systems. The variable LPF ranges from 100 Hz - 138 Hz.

CONFIGURATIONS

4 x Artec 506
 1 x Artec S15
 Standard Configuration

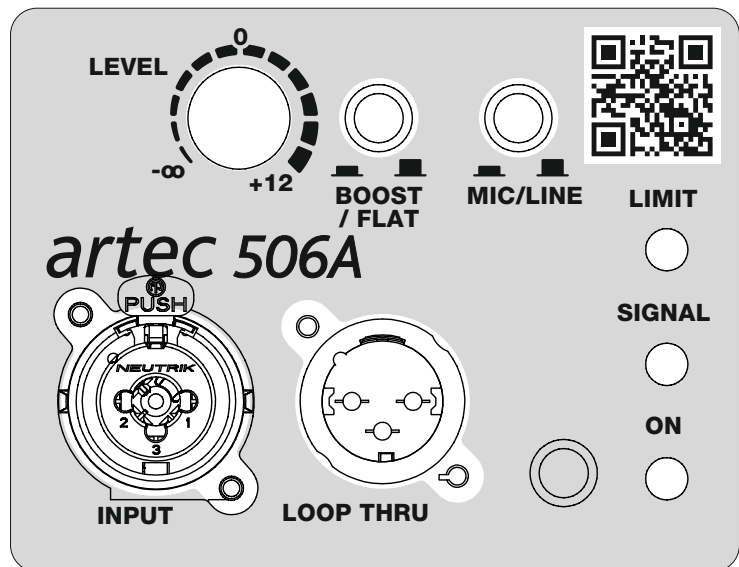
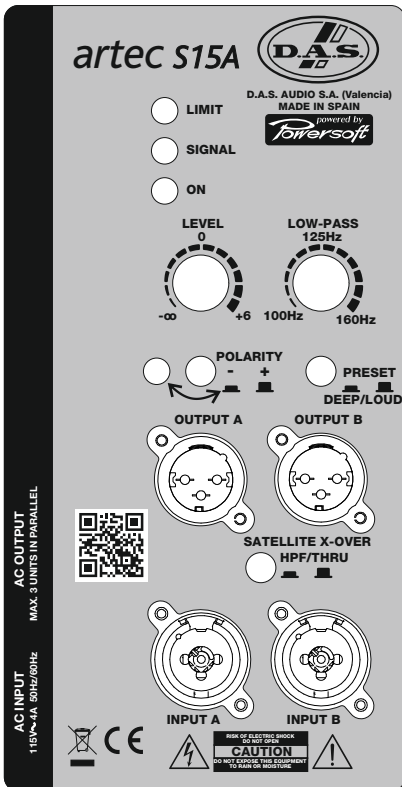
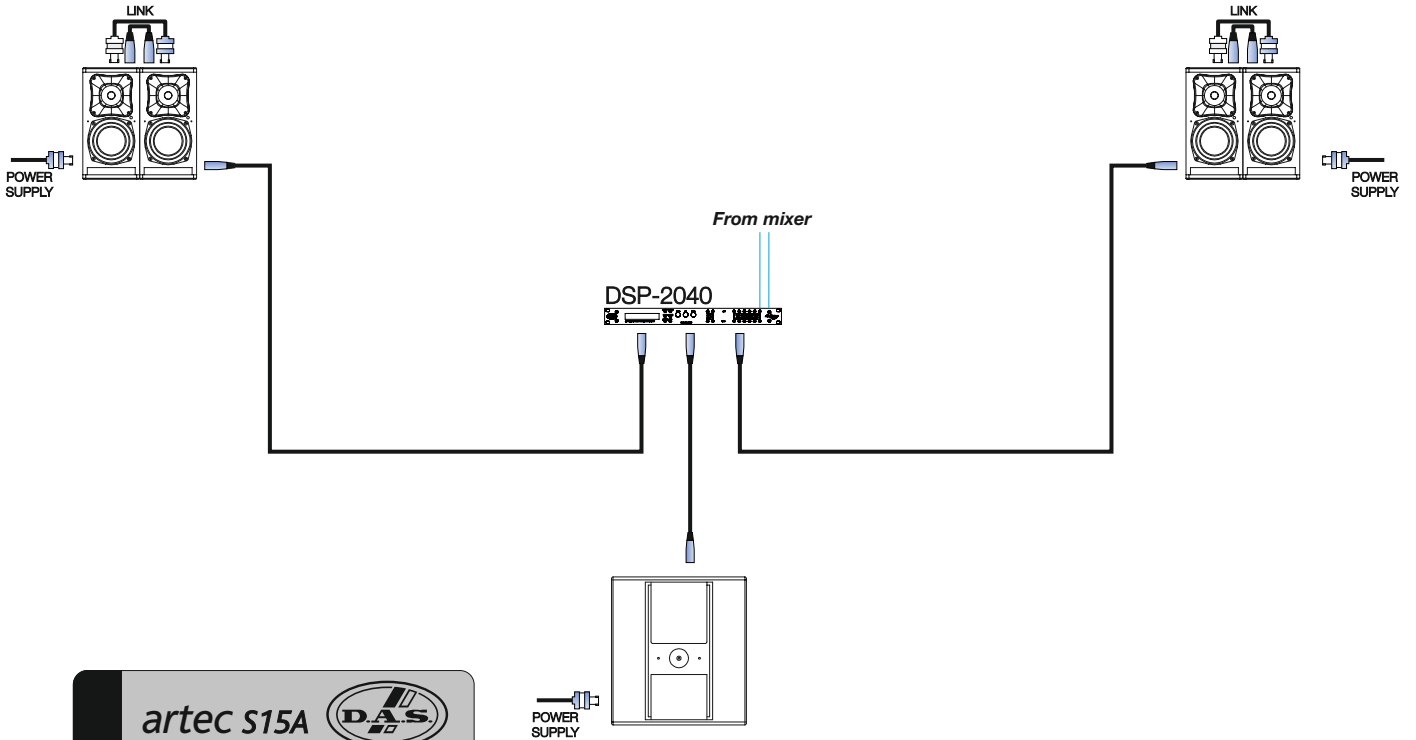

CONFIGURATIONS (cont'd)

4 x Artec 508
2 x Artec S15
Standard Configuration

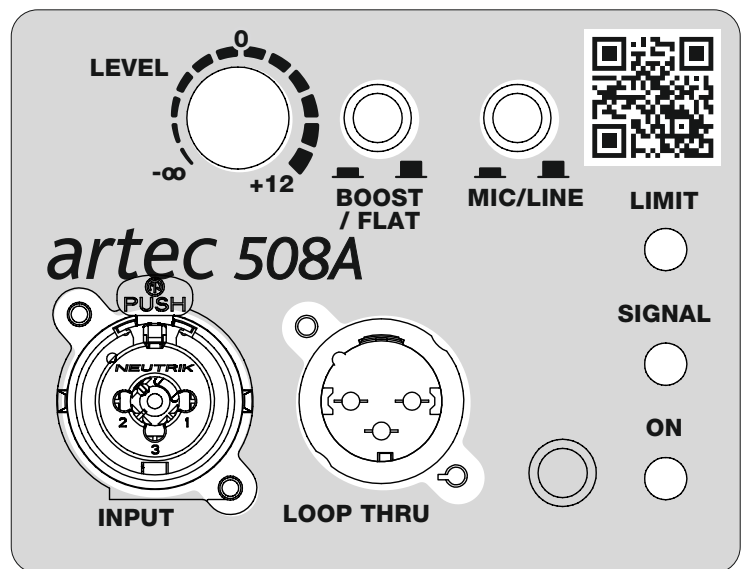
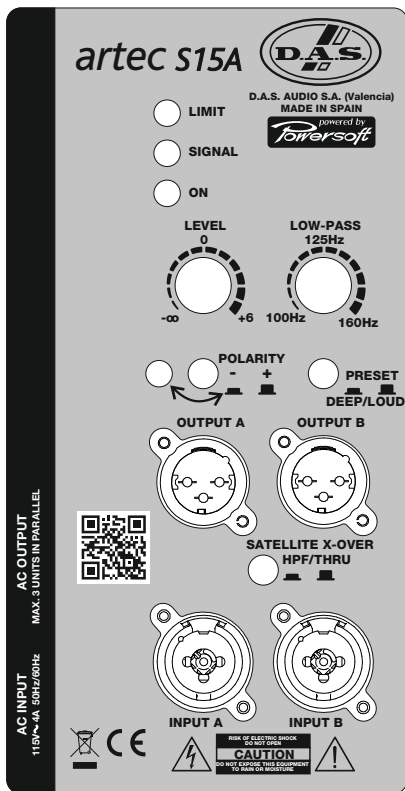
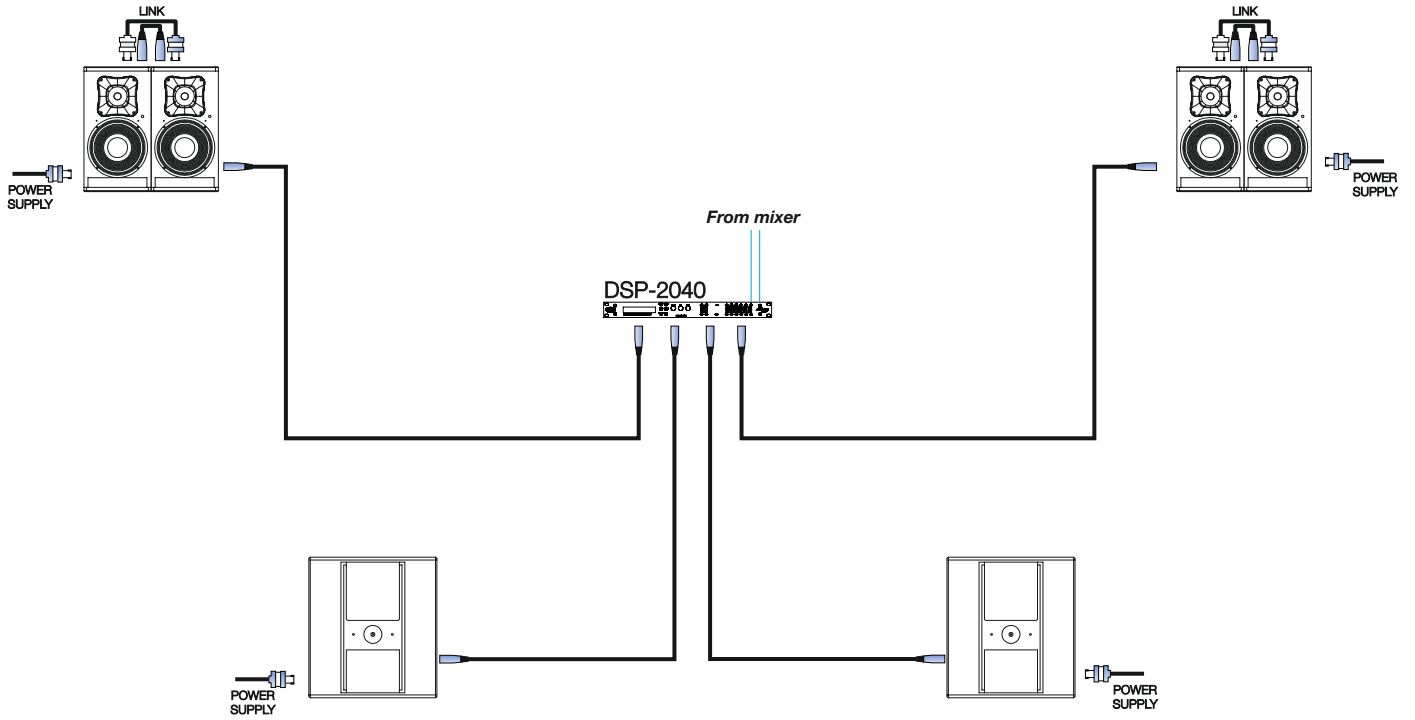

CONFIGURATIONS (cont'd)

4 x Artec 510
2 x Artec S15
Standard Configuration

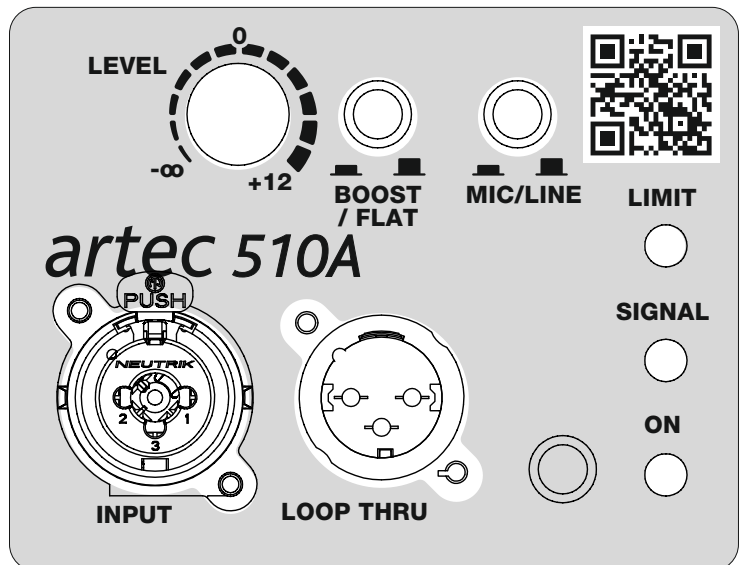
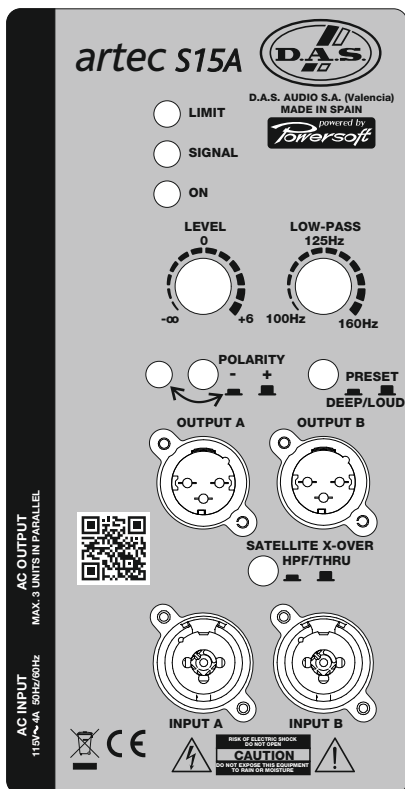
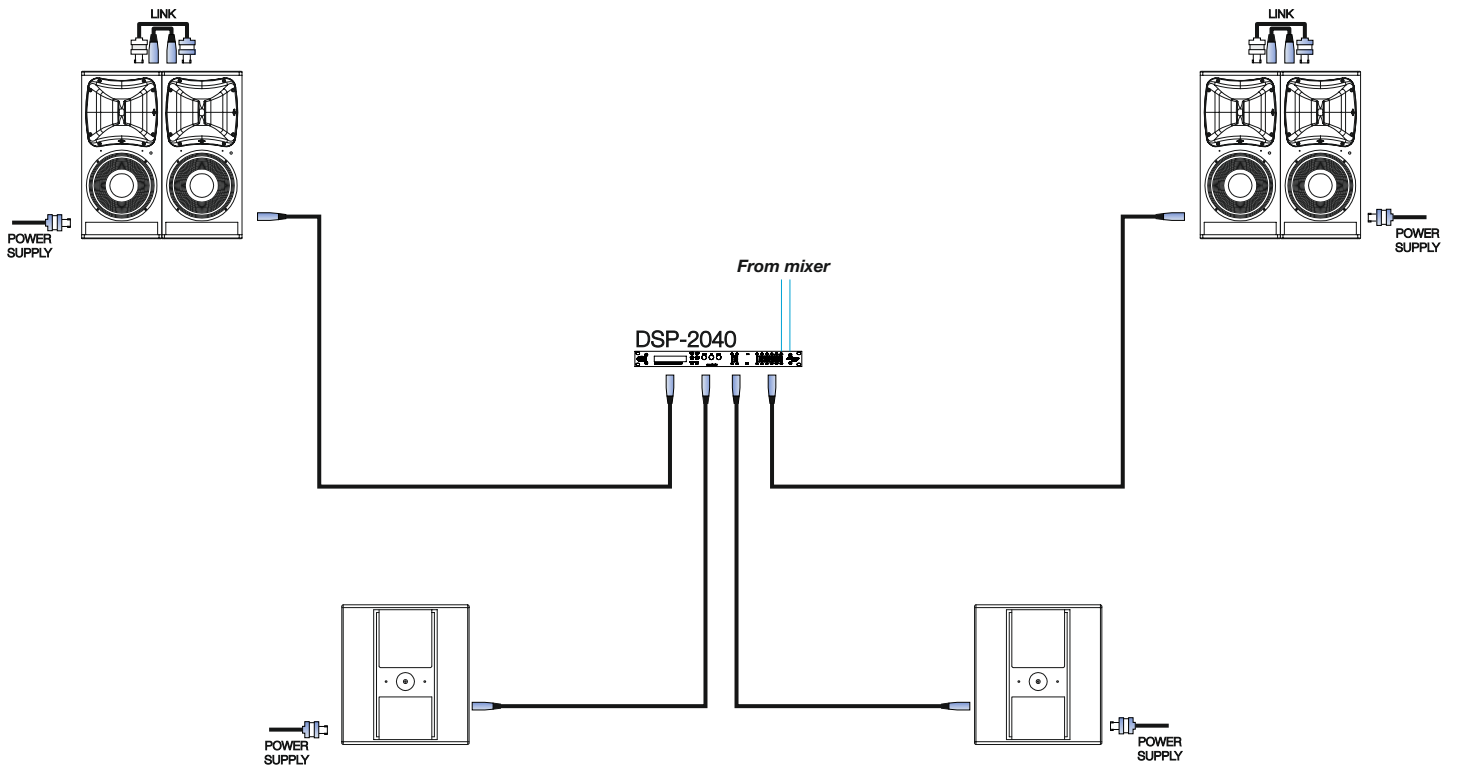

CONFIGURATIONS (cont'd)

4 x Artec 526
2 x Artec S15
Standard Configuration

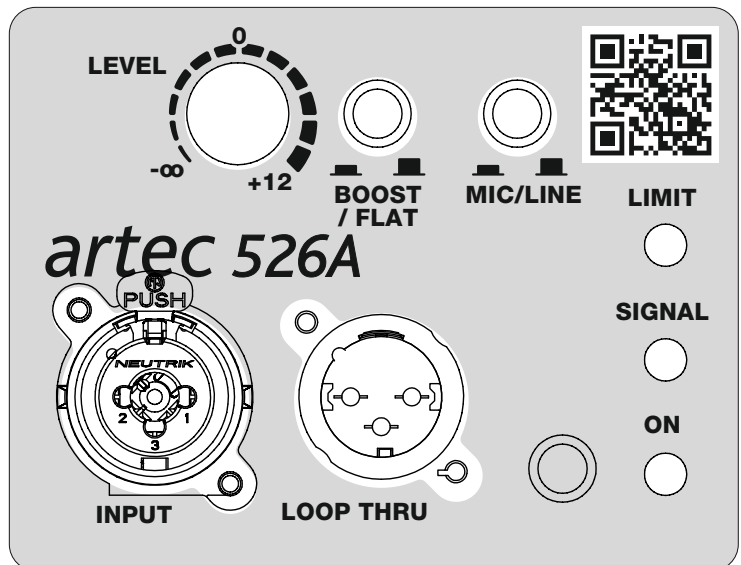
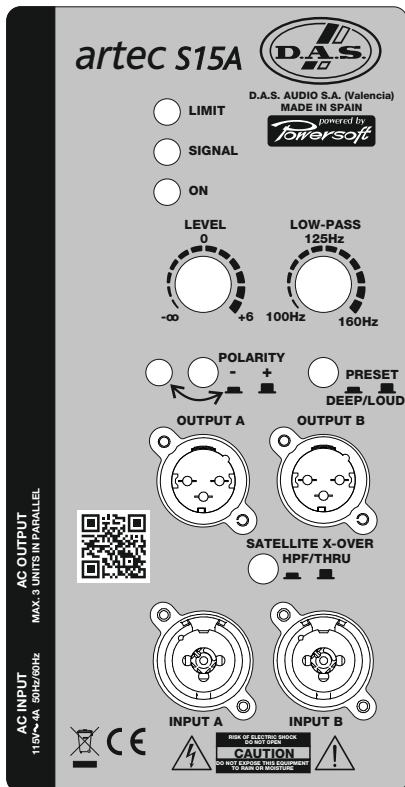
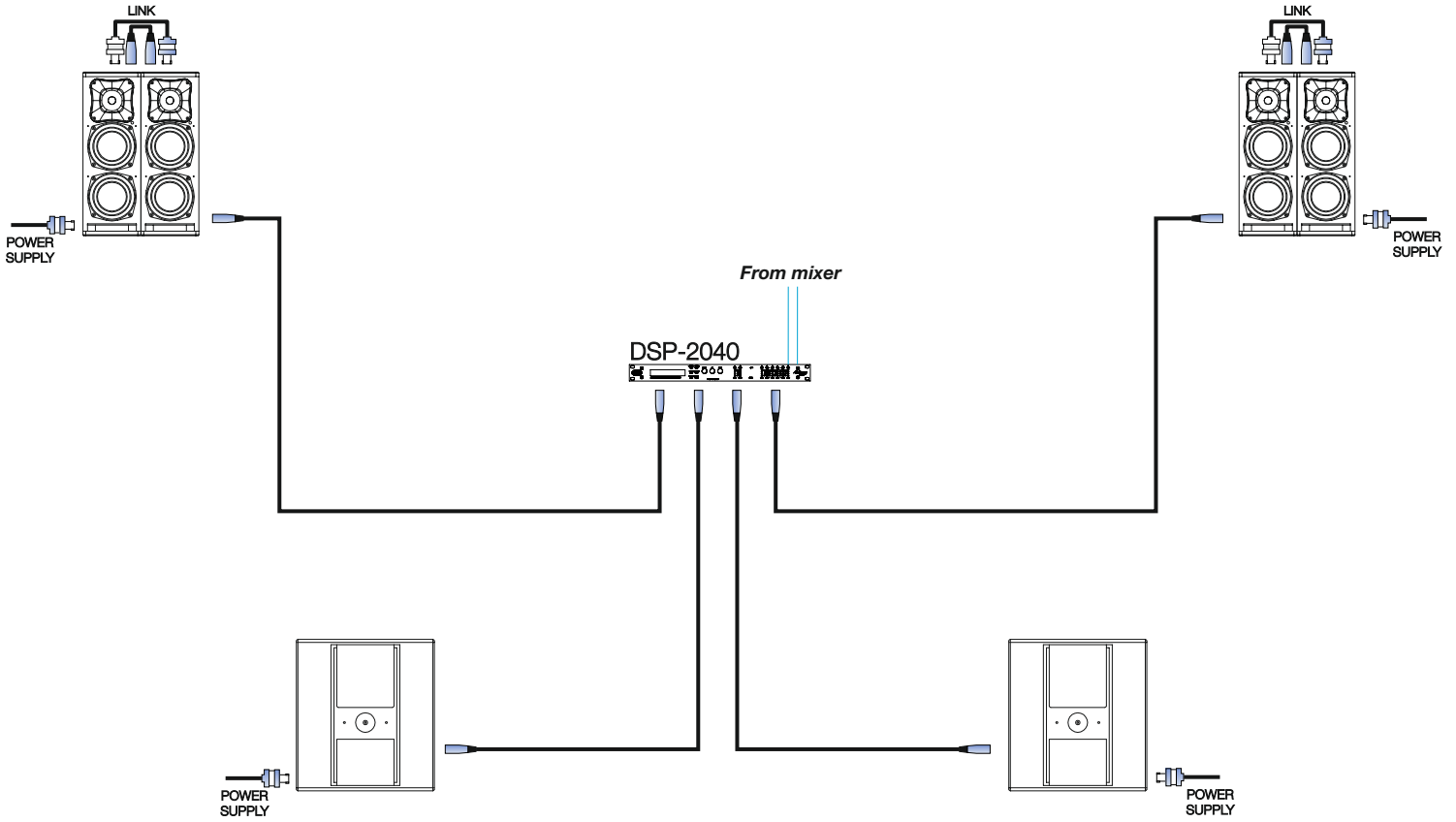

LINE DRAWINGS

ALL DIMENSIONS IN MILIMETERS

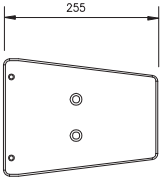
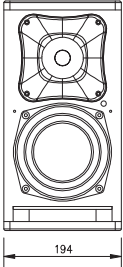
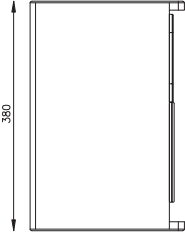
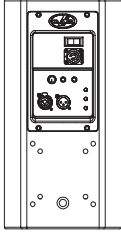
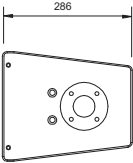
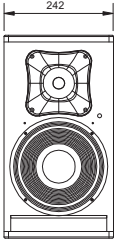
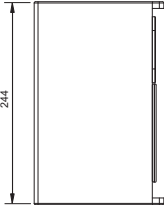
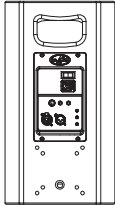
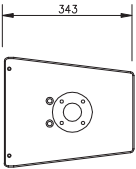
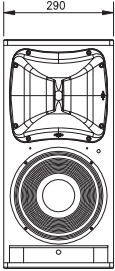
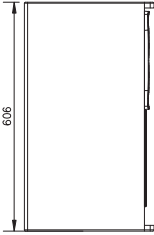
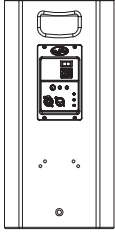
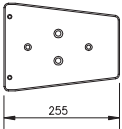
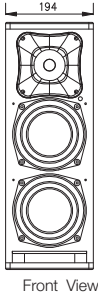
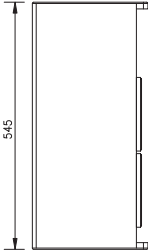
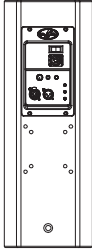
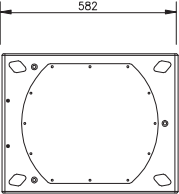
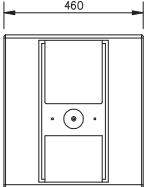
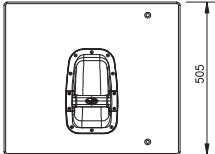
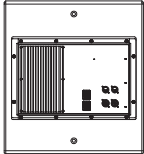
artec506A	 <p>Top View</p>	 <p>Front View</p>	 <p>Right View</p>	 <p>Rear View</p>
artec 508A	 <p>Bottom View</p>	 <p>Front View</p>	 <p>Right View</p>	 <p>Rear View</p>
artec510A	 <p>Bottom View</p>	 <p>Front View</p>	 <p>Right View</p>	 <p>Rear View</p>
artec526A	 <p>Top View</p>	 <p>Front View</p>	 <p>Right View</p>	 <p>Rear View</p>
artecS15A	 <p>Bottom View</p>	 <p>Front View</p>	 <p>Right View</p>	 <p>Rear View</p>

SPECIFICATIONS

Model	artec 506A	artec 508A	artec 510A	artec 526A	artec S15A
Power Amplifier	720 W peak 360 W continuous (Class D Bi-amplified)	720 W peak 360 W continuous (Class D Bi-amplified)	720 W peak 360 W continuous (Class D Bi-amplified)	720 W peak 360 W continuous (Class D Bi-amplified)	2000 W peak 1000 W continuous (Class D Bi-amplified)
Input Type	Balanced Differential Line	Balanced Differential Line	Balanced Differential Line	Balanced Differential Line	Balanced Differential Line
Input Impedance	Line: 20 kohms	Line: 20 kohms	Line: 20 kohms	Line: 20 kohms	Line: 20 kohms
Sensitivity	Line: 1.95V (+8dBu)	Line: 1.95V (+8dBu)	Line: 1.95V (+8dBu)	Line: 1.95V (+8dBu)	Line: 1.95V (+8dBu)
Frequency Range (-10 dB)	65 Hz - 20 kHz	55 Hz - 20 kHz	45 Hz - 20 kHz	60 Hz - 20 kHz	45 Hz - 138 Hz (variable LFP)
HF Horn Coverage Angles (-6 dB)	80° x 80°	80° x 80°	110° x 50°	80° x 80°	---
Maximum Peak SPL at 1m	114.5 dB	120.5 dB	121.5 dB	120.5 dB	134 dB
Transducers/ Replacement Parts	LF: 6P HF: M-34 / GM M-34	LF: 8C / GM 8C HF: M-34 / GM M-34	LF: 10P / GM 10P HF: M-60N / GM M-60	LF: 2x 6P4 / 6P4 HF: M-34 / GM M-34	LF: 15SX / GM 15LX
Enclosure Material	Birch Plywood	Birch Plywood	Birch Plywood	Birch Plywood	Birch Plywood
Color/Finish	Black or White/ Paint	Black or White/ Paint	Black or White/ Paint	Black or White/ Paint	Black or White/ Paint
Connectors	INPUT: Female XLR LOOP THRU: Male XLR AC INPUT: Male IEC	INPUT: Female XLR LOOP THRU: Male XLR AC INPUT: Male IEC	INPUT: Female XLR LOOP THRU: Male XLR AC INPUT: Male IEC	INPUT: Female XLR LOOP THRU: Male XLR AC INPUT: Male IEC	INPUT: 2x Female XLR LOOP THRU: 2x Male XLR AC INPUT: PowerCon NAC 3 FCA
AC Power Requirments	115V, 2.4A, 50 Hz / 60 Hz 230V, 1.2A, 50 Hz / 60 Hz	115V, 2.4A, 50 Hz / 60 Hz 230V, 1.2A, 50 Hz / 60 Hz	115V, 2.4A, 50 Hz / 60 Hz 230V, 1.2A, 50 Hz / 60 Hz	115V, 2.4A, 50 Hz / 60 Hz 230V, 1.2A, 50 Hz / 60 Hz	115V, 4A, 50 Hz / 60 Hz 230V, 2A, 50 Hz / 60 Hz
Dimensions (H x W x D)	38 x 19.5 x 25.5 cm 15 x 7.7 x 10 in	44.5 x 24.5 x 28.5 cm 17.5 x 9.6 x 11.2 in	60.5 x 29 x 34.5 cm 23.8 x 11.4 x 13.6 in	45 x 19.5 x 25.5 cm 21.3 x 7.7 x 10 in	51 x 46 x 58 cm 20 x 10.1 x 22.8 in
Weight	9 kg (19.8 lb)	9.9 kg (21.8 lb)	13 kg (28.7 lb)	11 kg (24.3 lbs)	31 kg (68.3 lbs)
Accessories	ANL-2 TRD-2+AXC-ZT TRD-6+AXC-ZT AXW-1 AXU-A506 AXF-A508 AXR-A500	ANL-2 TRD-2 TRD-6 AXW-1 AXU-A508 AXF-A508 AXR-A500	ANL-2 TRD-2 TRD-6 AXW-3 AXU-A510 AXF-A510 AXR-A500	ANL-2 TRD-2+AXC-ZT TRD-6+AXC-ZT AXW-1 AXR-A500	ANL-2 TRD-6

D.A.S. Audio S.A. continuously strives to enhance its products through investigation and development. All specifications are subject to change without prior warning.

AMPLIFIER

Description

1) INPUT :

1/4" Jack+XLR combined socket-type input signal connector. This is a balanced connector just like the LOOP THRU connector with the following pin assignments:

- 1 or S =GND (ground).
- 2 or T =(+) Non inverted input.
- 3 or R =(-) Inverted input.

2) LOOP THRU (except SUBs):

XLR-type output signal connector for connecting several units together and sending them all the same signal.

2) SATELLITE OUTPUT (only SUBs):

A and B, XLR-type output signal connectors for connecting several units together and sending them all the same input signal or filtered signal (by using THRU/HPF).

3) LIMIT :

Red LED indicates amplifier saturation. Amplifier limiter indicator lights.

4) SIGNAL :

Green LED indicates signal presence.

5) ON :

Green LED indicates that the unit is ON.

6) LEVEL / SUB LEVEL :

Potentiometer for adjusting the unit level.

7) BOOST / FLAT :

Button for switching between two types of frequency response.

7) LOW-PASS CROSSOVER (only SUB's) :

Button for LPF adjustment for subwoofer. We recommend 100 Hz.

8) MIC / LINE :

Button for switching between microphone and line sensitivities. **NEVER PRESS THIS BUTTON WITHOUT FIRST REDUCING THE LEVEL OF THE UNIT TO AVOID EXTREMELY HIGH SPL.**

9) AC INPUT :

PowerCon NAC3FCA mains connector (inserted, rotated and locked for ON). **Only use this equipment with an appropriate mains cord.**

10) PHASE :

Switch for inverting the phase of the unit.

11) DEEP/LOUD PRESET :

Button for switching between two of types frequency response, DEEP or LOUD.

12) AC OUTPUT (only artecS15A) :

PowerCon NAC3FCB connector for AC loop thru allows up to 6 units when using a 230V version (see unit's label)). **Only use this equipment with an appropriate mains cord.**

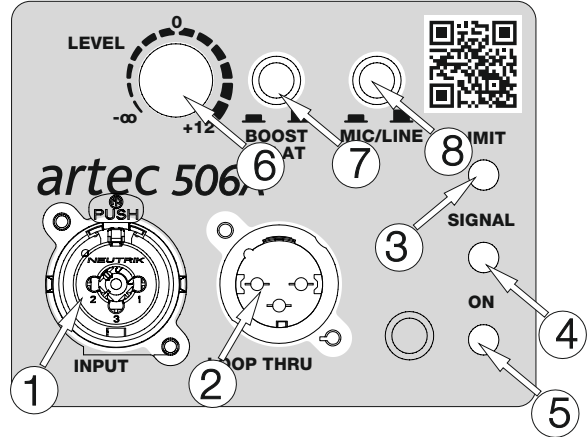

Amplifier of
artec506A, artec508A, artec510A & artec526A

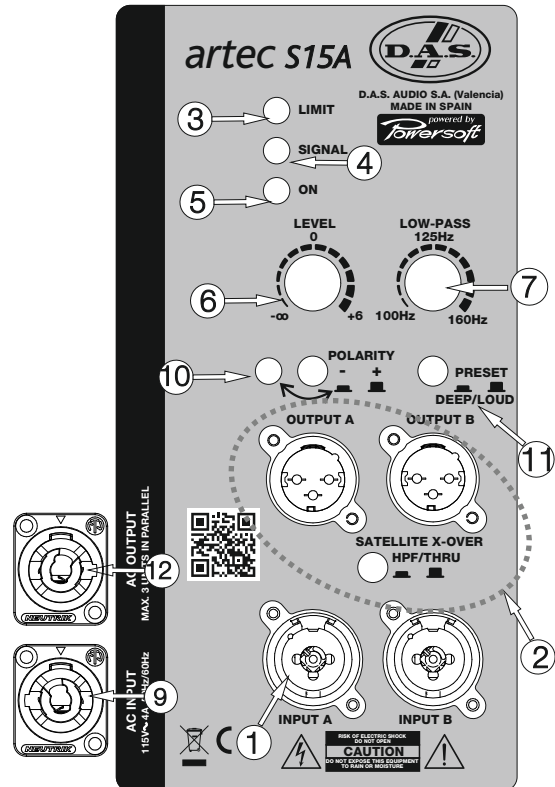

Amplifier of artecS15A

ON/OFF

A sound system should be switched on sequentially. Switch on the self-powered units last in your sound system (switch on the subwoofer before the mid-high system). Switch on the sound sources such as CD players or turntables, then the mixer, then the processors, and finally the self-powered unit. If you have several units, it is recommended that you switch them on sequentially one at a time.

Follow the inverse order when switching off, turning self-powered units off before any other element in the sound system.

Disconnect the device by removing the mains connector from the mains socket. The mains connector and mains socket must always be freely accessible and never covered or blocked in any way.

The models use a power cable equipped with a Neutrik PowerCon NC3FCA connector. Power can be daisy chained (only *artec S15A*) via the NC3FCB output connector (see details on product label).

IMPORTANT: Do not disconnect the unit while in use.

Ensure that the device is disconnected from the mains by observing that the ON LED is turned off. Please note that the ON LED can stay on for several seconds after the mains power has been disconnected.

Overload indicator

This device has an indicator (LIMIT LED) that lights when the signal is excessive.

The indicator should not be lit continuously. This distorts the signal (quickly fatiguing your ears) and may damage the speakers. Therefore, it is recommended that you never work with this LED on; at most it should blink only occasionally.

Equalisation

The unit does not need extreme settings of equalisation to produce quality sound. Avoid high levels of gain on the equalisers. Gain values above +3 dB on a console's EQ are not recommended.

Overheating

This equipment does not normally overheat during normal conditions of use. When overheating occurs, the unit protects itself. You should then find out why and if necessary contact an authorised dealer for technical assistance.

Normally it is enough just to let the unit cool down after you have corrected the problem so that the system functions properly again.

Keep grilles clean and dust-free.

Do not block or obstruct in any way the air entrance or exit while the equipment is in use.

Air circulates from the bottom to the top of the amplifier.

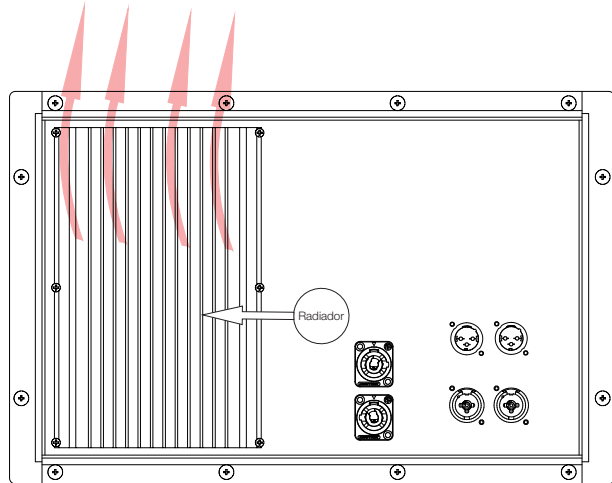

Low mains voltage

If mains voltage falls below the shutdown voltage for the unit, it will stop playing. When acceptable levels are regained, the unit will switch back on automatically.

Therefore the current consumed by a 115V version is double the 230V version to achieve the same acoustic power level.

Pink Noise Mains 230 Vrms	1/3 Potencia
<i>artec506A</i>	1.2A
<i>artec508A</i>	1.2A
<i>artec510A</i>	1.2A
<i>artec526A</i>	1.2A
<i>artecS15A</i>	2A

Troubleshooting

PROBLEM	CAUSE	SOLUTION
No sound from the unit. The SIGNAL LED does not light up.	1 – The signal source is sending no signal. 2 – Defective cable.	1 – Check that the mixer or sound source is sending signal to the UNIT. 2 – Check that the cable from the sound source to the UNIT is connected correctly. Replace the cable if defective.
Full power cannot be obtained. The LIMIT LED never lights up.	The signal source does not have a hot enough output.	If using a mixer, use the balanced output if available. Use a professional mixer with a hotter output.
Sound is distorted. The LIMIT LED is not on, or only lights up occasionally.	The mixer or signal source is distorting.	Turn mixer channel gains down. Check that none of your signal sources are distorting.
Sound is distorted and very loud and LIMIT LED lights up.	The system is overloaded and has reached maximum power.	Turn down the mixer's output.
Hum or buzz when a mixer is connected to the unit.	1.– The console probably has un-balanced outputs. You may be using an incorrect un-balanced to balanced cable. 2.– The mixer and the powered speaker are not plugged into the same mains outlet. 3.– The audio signal cable is too long or too close to an AC cable	1.– Read the appendix of this manual to make a correct un-balanced to balanced cable. 2.– Connect the mixer and the unit to the same mains outlet. 3.– Use a cable that is as short as possible and/or move the audio signal cable away from mains cables.
Hum or buzz when using lighting controls in the same building.	1.– The audio signal cable is too long or too close to the lighting cable. 2.– On a sound system with three-phase AC, the lighting equipment and the UNIT are connected to the same phase.	1.– Move the audio signal cable away from lighting cables. Try to find out at what point the noise is leaking into the system. 2.– Connect the sound system to a different phase than the lights. You may need the help of an electrician.
The ON LED does not light up when the mains connector is connected and the unit is switched to ON.	1.– Bad or loose AC connection to the UNIT or the mains outlet. 2 – Faulty AC cable.	1.– Check your connections. 2.– Check the cables, connectors and AC power with a suitable mains tester.

AXU Mounting

Introduction

The AXU series are designed for enclosures *artec 506A*, *artec 508A*, *artec 510A*, *artec 526A* and different versions.

Mounting instructions

You can consult the *AXU* mounting instructions for *artec 500 series* on the web: www.dasaudio.com

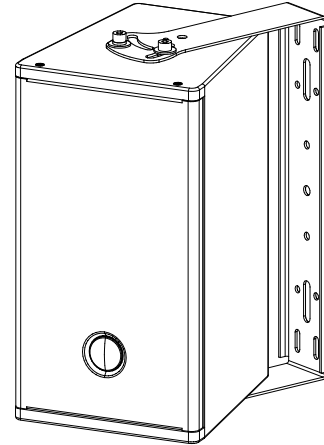

AXF Mounting (only for Artec 508A & Artec 510A)

Introduction

The AXF series are designed for enclosures *artec 506A*, *artec 508A*, *artec 510A* and different versions.

Mounting instructions

You can consult the *AXF* mounting instructions for *artec 500 series* on the web: www.dasaudio.com

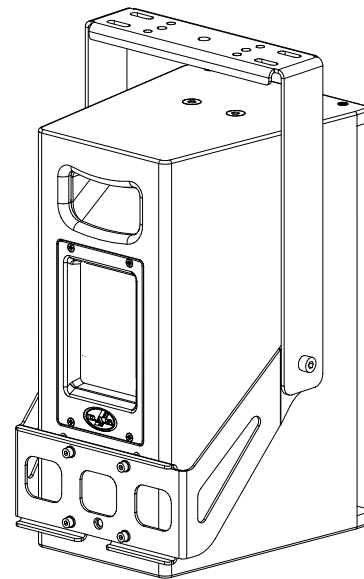

Safety Precautions

Wall plugs provided are to be used in brick walls only. For other wall materials, source the suitable wall plug before use.

D.A.S. Audio is not responsible for use other than the recommended or whether it be the result of insufficient strength of the support structure. Use only the screws and wall plugs supplied on surfaces that will provide sufficient support. Do not use on surfaces such as plaster, and gypsum. It is highly recommended and in most parts of the world mandatory, that a safety cable be used to secure the enclosure to the structure.

To ensure optimum safety, the installation should be checked thoroughly at regular intervals replacing all deteriorated elements.

Loosen the screws before reorienting the speaker. Never force the rigging elements.

Contact a licensed rigger if there is any doubt.

APPENDIX: Line connections: unbalanced and balanced

There are two basic ways to transport an audio signal with microphone or line level:

Unbalanced line: Utilising a two conductor cable, it transports the signal as the voltage between them. Electromagnetic interference can get added to the signal as undesired noise. Connectors that carry unbalanced signals have two pins, such as RCA (Phono) and ¼" (6.35mm, often referred to as jack) mono. 3 pin connector such as XLR (Cannon) may also carry unbalanced signals if one of the pins is unused.

Balanced line: Utilising a three conductor cable, one of them acts as a shield against electromagnetic noise and is the ground conductor. The other two have the same voltage with respect to the ground conductor but with opposite signs. The noise that cannot be rejected by the shield affects both signal conductors in the same way. At the device's input the two signals get summed with opposite sign, so that noise is cancelled out while the programme signal doubles in level. Most professional audio devices use balanced inputs and outputs. Connectors that can carry balanced signal have three pins, such as XLR (Cannon) and ¼" (6.35mm) stereo.

The graphs that follow show the recommended connection with different types of connectors to balanced processor or amplifier inputs. The connectors on the left-hand side come from a signal source, and the ones on the right hand side go to the inputs of the processor or amplifier. Note that on the unbalanced connectors on the left-hand side, two terminals are joined inside the connector. If hum occurs with balanced connections, try disconnecting the sleeve (ground) on the input connector. Note that the illustrations show what should be connected to what, but that pin locations on an actual XLR connector are different. Also, pin 2 hot is assumed on XLR connectors.

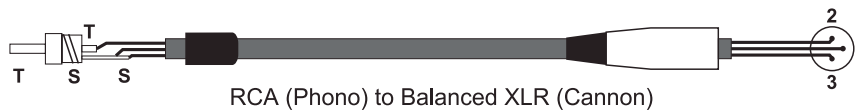
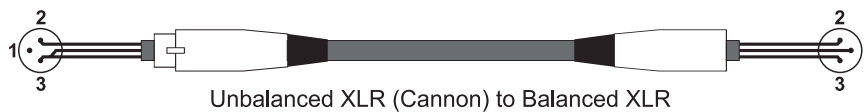

www.dasaudio.com



D.A.S. AUDIO, S.A.

C/ Islas Baleares, 24
46988 Fuente del Jarro
Valencia, SPAIN
Tel. 96 134 0525
Tel. Intl. +34 96 134 0860
Fax 96 134 0607
Fax Intl. +34 96 134 0607

D.A.S. AUDIO OF AMERICA, INC.

Sunset Palmetto Park
6816 NW 77th Court.
Miami, FL. 33166 - U.S.A.
TOLL FREE: 1-888DAS4USA
Tel. +1 305 436 0521
Fax +1 305 436 0528

D.A.S. AUDIO ASIA PTE. LTD.

25 Kaki Bukit Crescent #01-00/02-00
Kaki Bukit Techpark 1
Singapore 416256
Tel. +65 6742 0151
Fax +65 6742 0157