



USER'S MANUAL

Uninterruptible Power Supply GX 100 Series (5kVA)

Model M-UPS050AD1C
 M-UPS050AD1B

For Safe Use

- Handling of this manual

This manual describes important information for using this product safely. Please read this manual carefully before using this product. Use this product, after reading and understanding especially "Caution about Safety" and "Caution for Use" in this manual well. Furthermore, this manual should be retained for future reference.

High-safety Uses

This product is designed and manufactured for the general uses such as a general office use and a personal use, and it is not designed and not manufactured for uses (hereinafter called "high-safety uses") that require a high degree of safety, and are hazardous to human life and body if the required safety is not maintained, such as atomic nuclear command, aircraft flight control, air traffic control, mass transport control, life supporting system, and weapon control, etc.). Do not use this product without carrying out measures to ensure the required safety for high-safety uses. If using this product for high-safety uses, consult with our sales representatives.

Prevention of Radio Disturbance

Important
This product is class A information technology equipment based on the standard of Voluntary Control Council for Interference by Information Technology Equipment (VCCI). Using this product in a residential area may cause radio disturbance. In this case, the user may be requested to take an appropriate measure.

Prevention of Higher Harmonics Current Disturbance

This product conforms to IEC61000-3-12.

Introduction

An uninterruptible power supply is a device for supplying stable electric power to OA devices, FA devices, and computer devices.

This manual describes installation, running, daily management, troubleshooting, and maintenance of an uninterruptible power supply. Use an uninterruptible power supply correctly in accordance with this manual.

In this manual, an uninterruptible power supply (this product) is described as UPS for short.

● Content and organization of this manual

The organization of this manual is as follows:

Caution about Safety and Caution for Use

The cautions about safety are described. If you use the UPS, be sure to read this section.

- 1 **Unpacking**
The cautions for taking out the UPS from a box are described.
- 2 **Overview**
The name of each part and the operation mode of the UPS are described.
- 3 **Installation**
Installation of the UPS and connection of the cable are described.
- 4 **Running**
The methods of run and stop of the UPS are described.
- 5 **Inspection**
The cautions about daily inspection and rolling blackouts are described.
- 6 **Troubleshooting**
Troubleshooting is described.
- 7 **Maintenance**
Replacement of battery and cooling fan and method of storing the UPS are described.
- 8 **Appendix**
Rated specification and the additional description for UL type products are described.

Depending on the purpose to use, the chapters which should be especially referred to are as follows.

- For installation personnel Caution about Safety, Caution for Use, Chapters 1, 2, 3, and 4
- For users Caution about Safety, Caution for Use, Chapters 2, 4, 5, and 6
- For maintenance personnel Caution about Safety, Caution for Use, Chapters 2, 4, 5, and 7

- **Warning indication**

In this manual, the following warning indications are described so that user or the people around the UPS do not suffer damage to the body and property.



“Warning” indicates that death or serious injury may result, if the UPS is not used correctly.



“Caution” indicates that slight or moderate injury may result or that the UPS or user’s property may be damaged, if the UPS is not used correctly.

Important

“Important” indicates precautions for use of the UPS.

- **Symbols in this manual**

Symbols in this manual have the following meanings:



The state of the UPS is described.



Have a look if necessary. How to deal with, the reference place, etc. are described.

Attention

- Information in this manual is subject to change without notice.

Caution about Safety

- **List of important warnings**

The important warnings described in this manual are as follows.



Warning “Warning” indicates that death or serious injury may result, if the UPS is not used correctly.

Electric shock **Do not remove the cover of the UPS.**

Since there are parts of high voltage inside the UPS, there is the fear of an electric shock.



Caution

“Caution” indicates that slight or moderate injury may result or that the UPS or user’s property may be damaged, if the UPS is not used correctly.

Electric shock **Put neither a stick nor a finger into the cooling fan or the vent hole.**

Injury

There is the fear of an electric shock or an injury.

Electric shock **The maintenance other than daily inspection such as the replacement of battery or cooling fan must be performed by the specialist engineer.**

There is the fear of an electric shock.

Connect a grounding wire to a ground terminal. (class D grounding)

There is the fear of an electric shock.

A commercial power source usually has the electrodes of a grounding side and an ungrounded side separately from a grounding electrode (earthing). Be sure to check before connecting.

If connected in reverse, there is the fear of the malfunction by the noise or an electric shock.

When inspecting or maintaining the connection device (a device getting connected to the UPS) or the UPS, turn off the connection device and the UPS. And turn off the input breaker of the back of the UPS, and cut off connection to the AC input terminal (R, S).

There is the fear of an electric shock.

Caution about Safety

Injury Do not ride on the UPS and not put the objects on top of the UPS.

There is the fear of an injury or an overturn.

Injury Damage This UPS is a heavy load. Pay adequate attention to handling of the UPS.

Take out the UPS in the level and flat place. Pay adequate attention so that an accident such as an overturn or a drop will not occur. The mass of the UPS is as follows:

- M-UPS050AD1C : 84kg (without batteries : 48kg)
- M-UPS050AD1B : 78kg (without batteries : 42kg)

Fire Damage This UPS can be also installed transversely. If installing the UPS transversely, install it in the direction that took down the UPS to the right side as viewed from the front. Never install it in the direction that took down the UPS to the left side.

There is the fear of a fire or the UPS failure by the leak of battery.

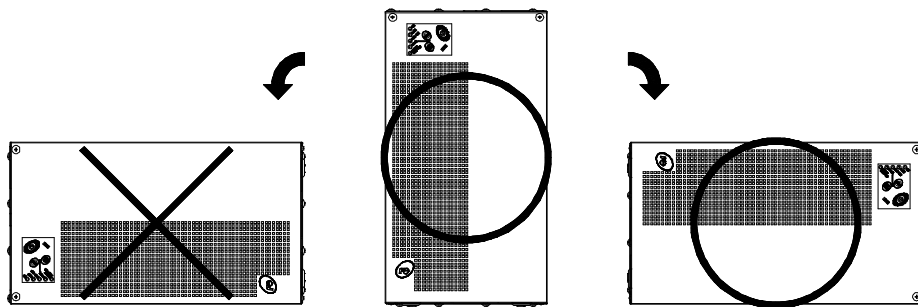

Damage **Do not use the UPS for the uses that may damage the human body or exert an important influence on the society and public.**

- The medical equipment which has an influence on the human life directly
- The equipment that may damage the human body
- The socially and publicly important computer system

Do not put the objects (CRT display or floppy disk, etc.) that are vulnerable to magnetism around the UPS.

There is the fear of having a bad influence on the objects.

Confirm that the voltage which was set by the voltage setup switch is within the input voltage range of the connection device.

There is the fear of damaging the connection device.

Do not operate the voltage setup switch during operation of the UPS.

There is the fear of damaging the connection device. And even if operating the switch during operation of the UPS, the output voltage cannot be changed.

Replace the battery periodically.

If continuing to use the battery that reached the end of battery life, there is the fear of the leak of battery and a smoke.

For the replacement battery, use the battery specified by our company, and the new battery.

If using the battery other than the specified battery, or using a new battery and an old battery in mixture, it becomes the cause of failure and trouble.

When performing the rolling blackouts or when turning off the input breaker of the back of the UPS, confirm that the RUN LED (green) is blinking slowly (in the cycles of approximately 1.6 sec.).

When the RUN LED is lighting up, if turning off the breaker of distribution board or the input breaker of the back of the UPS, the internal battery will be discharged, because it will become the same condition as a power failure.

There is the fear of the battery damage or the shortening of battery replacement cycle.

● **Warning label**

A warning label is affixed to the UPS.

- Never remove the label.
- This warning label is directed to the UPS users.

Caution for Use

Be careful about the following when using the UPS.

Important	“Important” indicates precautions for use of the UPS.
------------------	---

Do not install and store the UPS in the following places:

- In an outdoor location
- A place exposed to the elements
- An extremely humid place and a dusty place
- A place with corrosive gas or salinity
- A place subjected to direct sunlight
- A place near sparks or heating element
- An extremely hot or cold place, or place where the temperature fluctuates greatly
- A place where vibration and a shock are added

Do not perform the battery check in succession.

When the battery check is performed, the internal battery discharges actually and the voltage is checked.

If the battery check is performed in succession, there is the fear of the battery damage or the shortening of battery replacement cycle.

If the UPS is not used for a long time, charge the battery every two months.

Charge the battery by operating the UPS 12 hours or more every two months, and after charging the battery, perform the battery check.

If leaving the UPS unused for a long time, the battery becomes an over-discharge state due to self-discharge and there is fear that the battery becomes impossible to use.

The disposal of used battery has legal restrictions.

Request the disposal to industrial waste disposal contractor or consult with a sales agency that you purchased the UPS, or the maintenance agency.

Do not block the cooling fan and the vent hole and not use the UPS in a stuffy place.

The cooling fan and the vent hole are equipped in order to cool the inside of the UPS.

There is fear that the inside and ambient temperature of the UPS get out of the rated specification.

Replace the cooling fan periodically.

If continuing to use the fan that reached the end of fan life, there is fear that the inside temperature of the UPS gets out of the rated specification.

Do not use 5 to 9 of the voltage setup switch.

The UPS will become unable to start up normally.

The allowable voltage between the input electric cable of the UPS and the ground is 230 VAC.

If applying the voltage of more than 230 VAC, the filter circuit of the input part may be damaged.

The input surge voltage capacity of the UPS is 5kV peak ($1.2 \times 50\mu\text{s}$). However, if the model of the UPS is "-UC", it is 2kV peak ($1.2 \times 50\mu\text{s}$).

If applying the surge voltage of more than 5kV peak (2kV peak in case of "-UC"), the filter circuit of the input part may be damaged.

The input voltage of the UPS is 85 to 138 VAC.

When input voltage is different from the rated specification (200 VAC, etc.), install a transformer at the outside of the UPS to convert voltage. If applying the voltage that exceeds the input voltage range, the UPS may be damaged.

The input voltage of the UPS should be within the rated input voltage range of the connection device.

During the bypass operation, the input voltage of the UPS is outputted to the connection device as the output voltage as it is. If applying the voltage that exceeds the rated voltage range of the connection device, the connection device may be damaged.

Do not apply the single-line grounding at the output side.

It is not insulated between the input and output of the UPS. Therefore, do not apply the single-line grounding at the output side.

There is the fear of causing the trouble by the noise or the failure.

When connecting the UPS to a three-phase power supply system, be sure to connect the grounding phase of the three-phase power supply system to the electrode of a grounding side of the AC input of the UPS.

If connecting the UPS to an ungrounded power source, there is the fear of causing the malfunction.

When using a generator temporarily during the rolling blackouts, use a generator satisfying the following specification.

If connecting a generator not satisfying the following specification to the input part of the UPS, there is the fear of causing the malfunction or damage of the UPS.

- Voltage variation: 85 to 138 VAC
- Frequency variation: within $\pm 5\%$ of the rated frequency (1Hz/sec.)
- Voltage waveform distortion: within 5%
- Voltage zero-cross condition: Zero-cross must not occur more than twice per cycle.

Index

	Introduction.....	i
	Caution about Safety	iii
	Caution for Use.....	vi
1	Unpacking	
1.1	Opening the Packing	1
	● Opening the packing	
	● Confirming the contents of the packing	
2	Overview	
2.1	Name and Main Function of Each Part	2
2.2	Operation Mode of the UPS	4
	● At the normal operation	
	● At the battery operation (In the event of an input power failure)	
	● At the bypass operation (In the event of the abnormalities inside the UPS)	
3	Installation	
3.1	Installing the UPS.....	6
	● Caution about installation	
	● Determining an installation location	
	● Determining the installation method	
	● Installation method	
3.2	Connecting the Cable	10
	● Caution about connecting the cable	
	● Preparation before connecting the cable	
	● Connecting the input and output cable	
3.3	Interface Port.....	13
	● CN1 (No-voltage contact signal interface)	
	● CN2 (RS-232C interface)	
3.4	Setting up the Output Voltage	15
	● The setup procedures of the rated output voltage	
4	Running	
4.1	Turning on the UPS.....	17
	● Confirming cable connection	
	● Turning on the UPS	
	● Turning on the connection device	
4.2	Turning off the UPS.....	20
	● Turning off the connection device	
	● Turning off the UPS	
5	Inspection	
5.1	Care and Daily Inspection	22
	● How to care for the UPS	
	● Daily inspection	

5.2	Caution and Measures for the Rolling Blackouts	24
	● Operation before the rolling blackouts	
	● Operation after the rolling blackouts	
5.3	Inspecting the Battery (Battery Check)	25
	● Confirming the state of the UPS	
	● Using the manual check function	
	● Charging the battery	
6	Troubleshooting	
6.1	If a Warning Beep Sounds	29
6.2	Operation Mode List	30
	● Types of blink of LED	
	● Types of the warning beep	
	● Operation mode list	
7	Maintenance	
7.1	Replacing the Battery	35
	● Timing of the battery replacement	
	● The method of battery replacement	
	● Disposal and storage of battery	
7.2	Replacing the Cooling Fan	38
	● Timing of the cooling fan replacement	
	● The method of cooling fan replacement	
7.3	When Not Using the UPS (Storage)	40
	● Work before storage	
	● If a storage period exceeds two months	
8	Appendix	
8.1	Rated Specification	41
8.2	Additional Description for UL Type	43

1 Unpacking

1.1 Opening the Packing

- **Opening the packing**

 Caution	
Injury Damage	This UPS is a heavy load. Pay adequate attention to handling of the UPS. Take out the UPS in the level and flat place. Pay adequate attention so that an accident such as an overturn or a drop will not occur. The mass of the UPS is as follows: <ul style="list-style-type: none">• M-UPS050AD1C : 84kg (without batteries: 48kg)• M-UPS050AD1B : 78kg (without batteries: 42kg)

1. Open the packing box and take out the UPS.

- **Confirming the contents of the packing**

2. Confirm that there is no damage to the appearance of the UPS.

3. Confirm that all accessories are contained.

UPS model	Accessories	No. of pcs
M-UPS050AD1C	User's manual (this document)	1 copy
M-UPS050AD1B	Guarantee (this document) Bracket (with 6 fixing screws)	1 set



If the UPS got damaged or accessories are missing:
Contact a sales agency that you purchased the UPS.

2 Overview

2.1 Name and Main Function of Each Part

This chapter describes the name and main function of each part of the UPS.

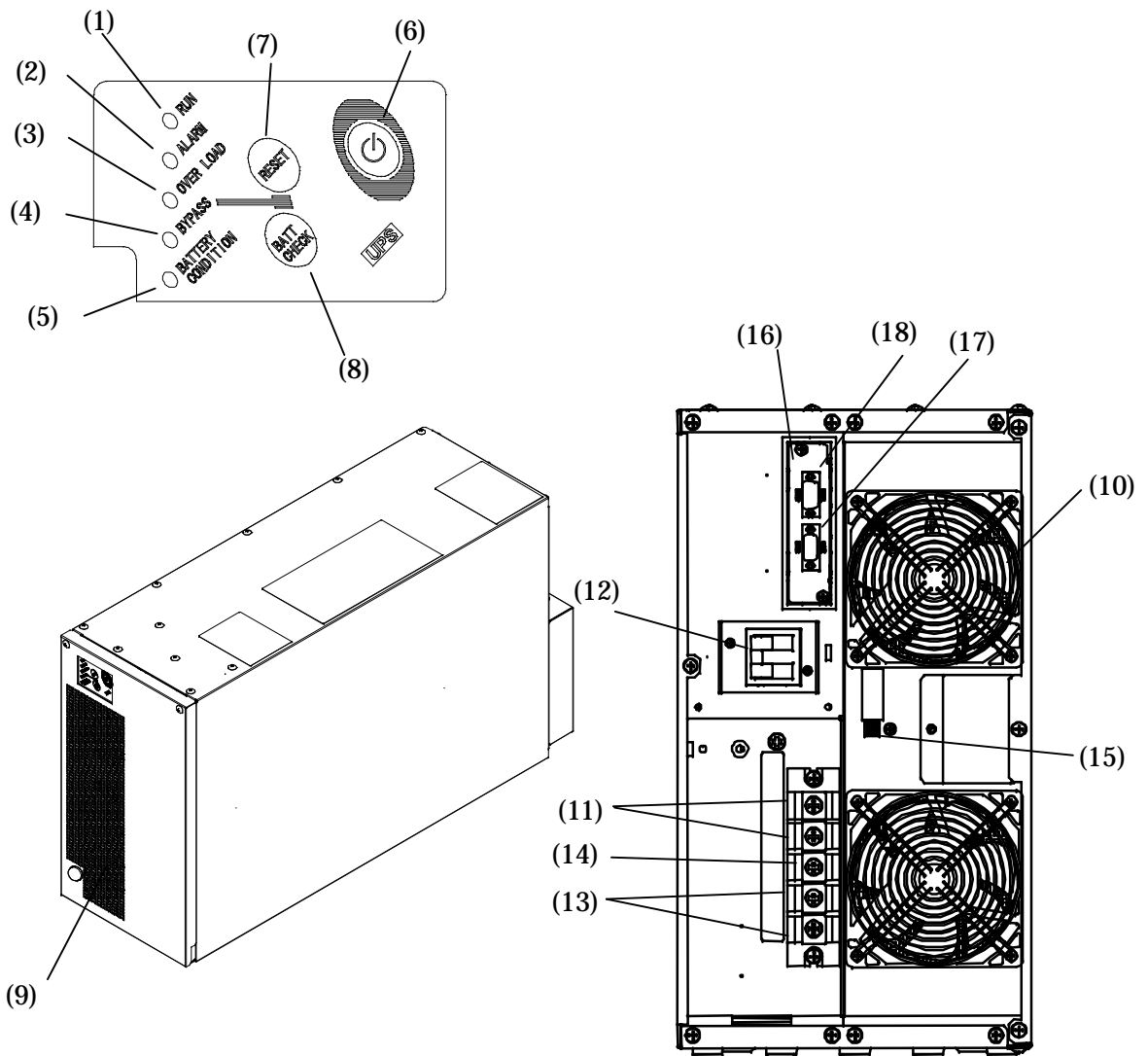

	Name	Main function
(1)	LED	RUN It blinks (green) when the UPS is connected to an input power source. It lights up (green) while the UPS is operating normally.
(2)		ALARM It lights up (orange) when the abnormalities occurred inside the UPS.
(3)		OVER LOAD It lights up (orange) when the load capacity of the connection device exceeded the rated specification.
(4)		BYPASS It lights up (orange) while the UPS is performing the bypass operation.
(5)		BATTERY CONDITION When the battery is normal, it indicates the amount of battery charge according to the type (lights out, blinking, or lighting) of lighting (green). When the battery is abnormal, it lights up (orange).
(6)	Switch	RUN/STOP It is the switch for performing the operation and stop of the UPS. The operation and stop are switched each time one presses the switch for approximately 1 second.
(7)		RESET Press this switch when stopping the warning beep. Also, if pressing the switch for approximately 3 seconds after restoring the failure, the ALARM LED goes out.
(8)		BATT CHECK It is the switch for performing the battery check manually. By pressing the switch for approximately 2 seconds, the battery check is performed.
		BYPASS If switching to the bypass operation forcibly (manually) while the UPS is operating normally, press the switches (7) and (8) simultaneously for approximately 3 seconds. When pressing the switches simultaneously for approximately 3 seconds again, the UPS returns to the normal operation.
(9)	Vent hole	It ventilates the inside of the UPS. The direction of air is intake.
(10)	Cooling fan	It cools the inside of the UPS. The direction of air is exhaust.
(11)	Input terminal block	Connect the UPS to an input power source.
(12)	Input breaker	It is the breaker for protecting the input circuit.
(13)	Output terminal block	Connect the UPS to an output system.
(14)	Ground terminal	Connect a grounding wire.
(15)	Voltage setup switch	Set the output voltage.
(16)	Interface slot	Mount various interface cards.
(17)	Contact signal (CN1)	It outputs a no-voltage contact signal.
(18)	RS-232C (CN2)	It is a RS-232C interface.

2.2 Operation Mode of the UPS

- **At the normal operation**

While the UPS is operating normally, the UPS operates an AC power supply as an input, and supplies the output of constant voltage to connection device. Simultaneously, the UPS charges an internal battery and prepares for the battery operation.

Output frequency is synchronized with input frequency.

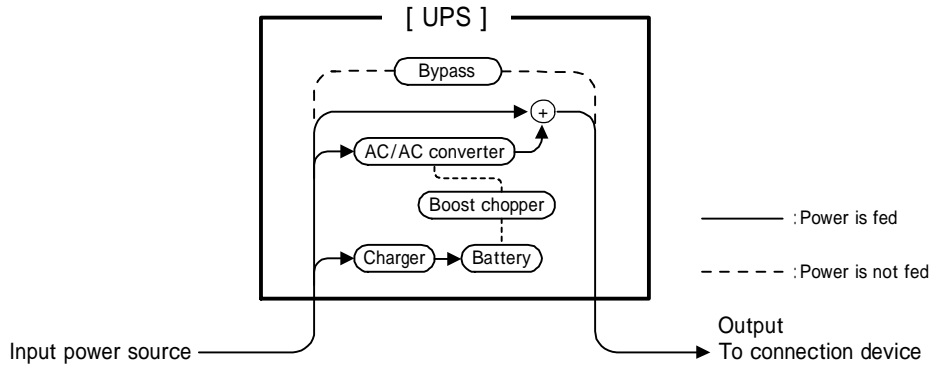

Flow of electricity during normal operation

- **At the battery operation (In the event of an input power failure)**

When the voltage or the frequency of an AC input power source is abnormal, the UPS starts the electric discharge from the battery, and continues to supply the stable electric power to the connection device. In addition, the changeover to the battery operation is performed without instantaneous interruption.

If the input power source returns, the UPS will return to the above normal operation automatically.

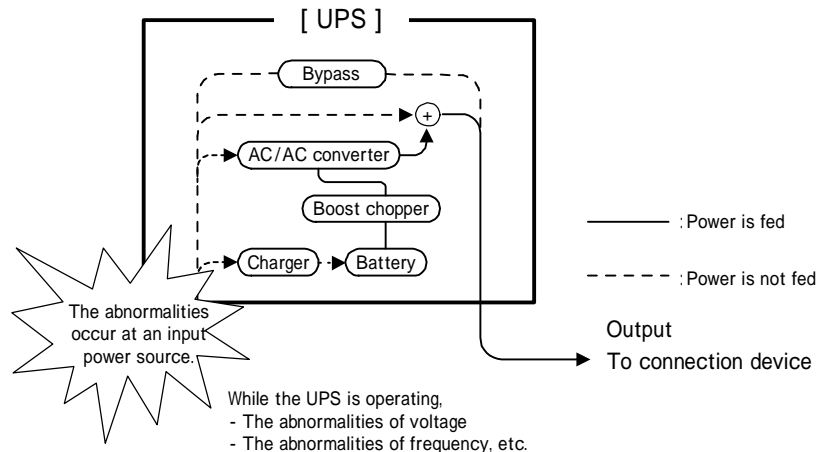

Flow of electricity during battery operation

- **At the bypass operation (In the event of the abnormalities inside the UPS)**

When the abnormalities occur inside the UPS, an output switching circuit switches to a bypass circuit, and continues to supply electric power through the bypass circuit to the connection device.

In addition, changeover between circuits can switch without instantaneous interruption.

It is also the same as when switching to the bypass operation manually with the switch on the front of the UPS.

At the bypass operation, electric power is not supplied (battery operation) from the battery to the connection device.

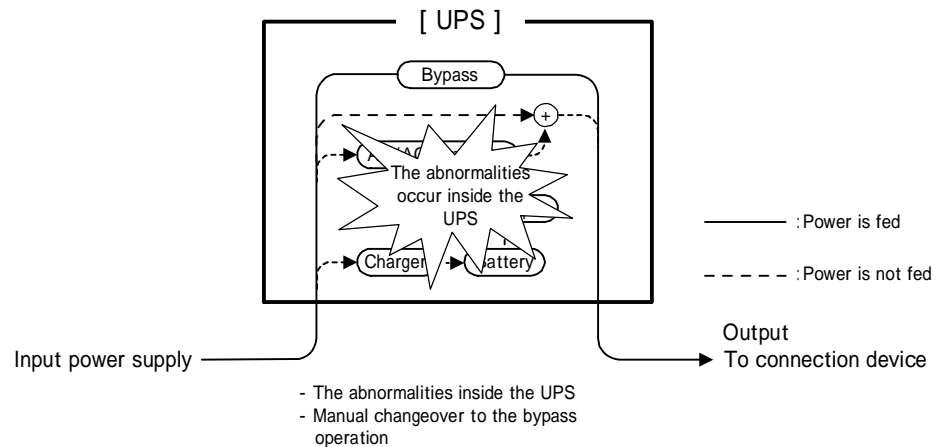

Electricity flow during bypass operation

3 Installation

3.1 Installing the UPS

- **Caution about installation**

 Caution	
Injury	Do not ride on or put an object on the UPS. There is fear of an injury or an overturn.
Damage	Do not put an object (CRT display or floppy disk, etc.) vulnerable to magnetism around the UPS. There is fear of exerting a bad influence on the object.

- **Determining an installation location**

Important
<p>Do not install the UPS in the following places:</p> <ul style="list-style-type: none">• In an outdoor location• A place exposed to the elements• An extremely humid place and a dusty place• A place with corrosive gas or salinity• A place subjected to direct sunlight• A place near sparks or heating element• An extremely hot or cold place or place where the temperature fluctuates greatly• A place where vibration and a shock are added
<p>Do not use the UPS in a residential area or its adjacent area.</p> <p>This UPS is class A information technology equipment based on the standard of Voluntary Control Council for Interference by Information Technology Equipment (VCCI). Using this UPS in a residential area may cause radio interference. In this case, the user may be requested to take an appropriate measure.</p>
<p>Do not block the vent hole and cooling fan or use the UPS in a stuffy place.</p> <p>The vent hole and cooling fan are equipped in order to cool the inside of the UPS. There is a possibility that the inside and ambient temperature of the UPS may get out of the rated specification.</p>

The following spaces are required for an installation location.

- The UPS takes in air through the vent hole on the front of the UPS and exhausts air through the cooling fan on the back of the UPS. Therefore, the space of 10cm or more is required in the front and rear of the UPS.

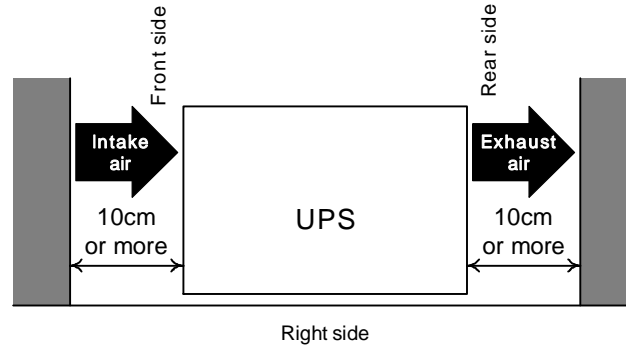

When performing maintenance of the UPS:
The space of approximately 1m is required in the front and rear of the UPS.

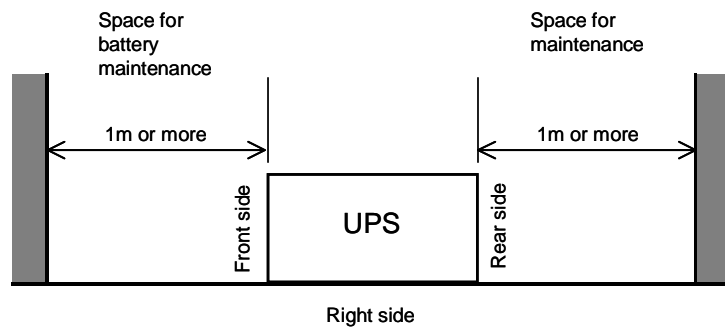

Confirm the environment of the installation location. The recommended environment in consideration of the battery life, etc. is as follows.

Item	Recommended environment
Temperature	15 to 25 degrees C
Humidity	30 to 70% (no condensation)

● Determining the installation method

 **Caution**

Fire Damage This UPS can be installed laying down. If installing laying the UPS down, tilt it only to the right side, seeing from the front. Never tilt the UPS to the left side.

There is fear of a fire or the UPS failure owing to a leak of battery.

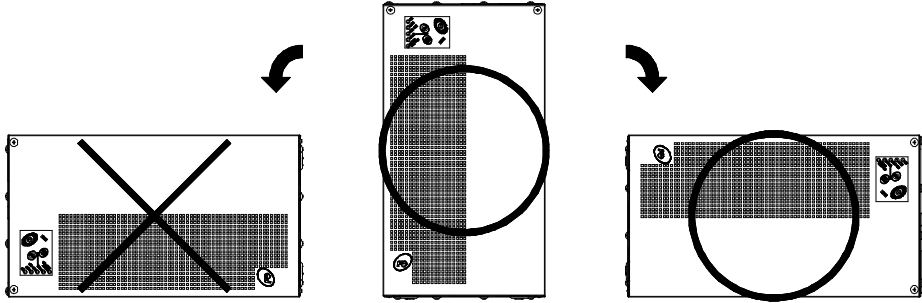

 This UPS can be put in a 19-inch rack using the optional rack mount attachment kit.

● Installation method

⚠ Caution	
Injury Damage	<p>The UPS is heavy. Pay enough attention to handling the UPS.</p> <p>Take out the UPS in a level and flat place. Pay enough attention to prevent an accident such as an overturn or a drop. The weight of the UPS is as follows:</p> <ul style="list-style-type: none"> • M-UPS050AD1C : 84kg (without battery: 48kg) • M-UPS050AD1B : 78kg (without battery: 42kg)

When using the bracket (standard attachment) to fasten the UPS to the floor, first fasten the bracket to the UPS, and fasten the bracket to the floor. This bracket is for preventing an overturn of the UPS.

[M-UPS050AD1C]

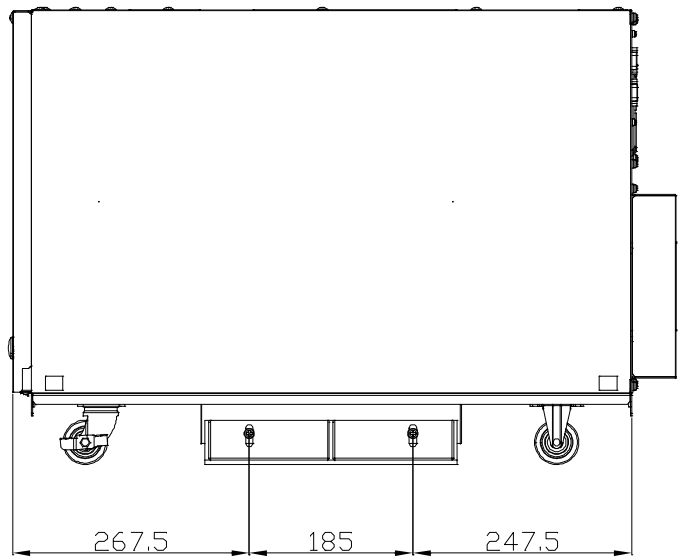
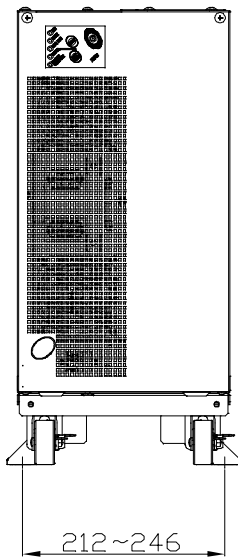

[M-UPS050AD1B]

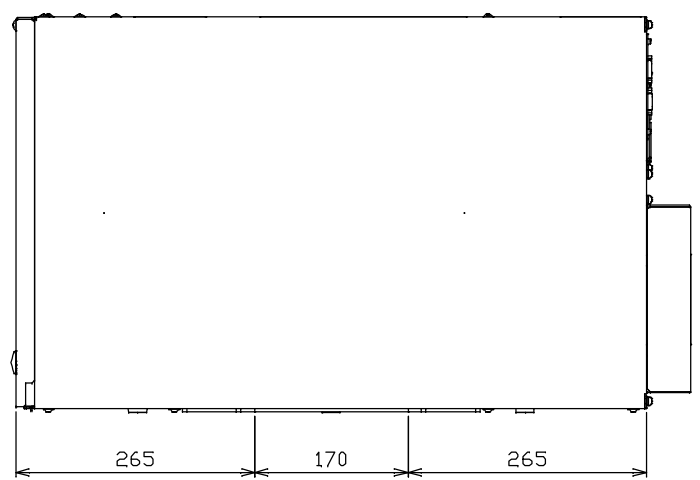
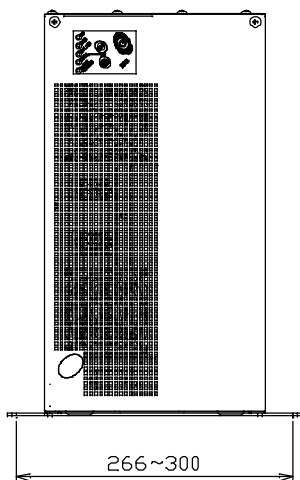

3.2 Connecting the Cable

- **Caution about connecting the cable**

 Caution	
Electric shock	<p>Connect a grounding wire to a ground terminal. (class D grounding)</p> <p>There is fear of an electric shock.</p> <p>A commercial power ordinarily has electrodes of a grounding side and an un-grounding side apart from a grounding electrode (ground). Be sure to confirm before connecting.</p> <p>If connected in reverse, there is fear of the malfunction by noise or the electric shock.</p>

Important	
<p>The permissible voltage between the input electric cable of the UPS and the ground is 230 VAC.</p> <p>If the voltage more than 230 VAC is applied, the filter circuit of the input part may be damaged.</p>	
<p>The permissible input surge voltage of the UPS is 5kV peak (1.2 × 50μs). However, if the model of the UPS is "-UC", it is 2kVpeak (1.2 × 50μs).</p> <p>If the surge voltage more than 5kV peak ("-UC" is 2kV peak) is applied, the filter circuit of the input part may be damaged.</p>	
<p>The input voltage of the UPS is 85 to 138 VAC.</p> <p>When input voltage is different from the rated specification (200 VAC, etc.), install a transformer at the outside of the UPS to convert voltage. If the voltage more than the range of the input voltage is applied, the UPS may be damaged.</p>	
<p>Connect the UPS to an input power supply within the range of the rated input voltage of the connection device.</p> <p>At the bypass operation, the input voltage of the UPS is outputted to the connection device directly. If the voltage more than the range of the rated input voltage of the connection device is applied, the connection device may be damaged.</p>	
<p>Do not apply single-line grounding on the output side.</p> <p>Between the input and output of the UPS is not insulated. Therefore, do not apply single-line grounding on the output side.</p> <p>There is a possibility of becoming the cause of the trouble by noise or the failure.</p>	

● **Preparation before connecting the cable**

Important
<p>When connecting the UPS to a three-phase power supply system, be sure to connect the grounding phase of the three-phase power supply system to the electrode of a grounding side of the AC input of the UPS.</p> <p>If connecting to an un-grounding power supply, there is a possibility of becoming the cause of the malfunction.</p> <p>When using a generator temporarily during the rolling blackouts, use a generator satisfying the following specification.</p> <p>If connecting a generator not satisfying the following specification to the input part of the UPS, there is a possibility of becoming the cause of the malfunction or damage of the UPS.</p> <ul style="list-style-type: none"> • Voltage variation: 85 to 138 VAC • Frequency variation: within rated frequency $\pm 5\%$ (1Hz/sec.) • Voltage waveform distortion: within 5% • Voltage zero-cross condition: Zero-cross must not occur twice or more in 1 cycle.

1. Confirm the input power supply. The input power supply which can connect with this UPS is as follows.

UPS model	Breaker capacity	Input capacity	Input voltage	Input frequency	Number of phase
M-UPS 050AD1C	75A or more	5kVA	85 to 138 VAC	50/60Hz $\pm 5\%$ (Note)	Single-phase two-wire
M-UPS050 AD1B					

Remarks If the input voltage and the frequency are out of this range, the UPS may become the following state or be damaged.



When the UPS is turned on:

The UPS will become the “input error at startup”. In this case, the UPS cannot be started up.



While the UPS is operating:

“Abnormalities of input voltage” is detected and the battery operation is performed. If the UPS is connected to an input power supply which gets out of this range frequently, by repeating the charge and discharge of the battery, the battery will be in an empty state or will become the cause of damage.

Note) The input frequency is automatically chosen according to the area in which the UPS is used.

3 Installation

2. The specifications of the input and output terminal block are as follows. Select the crimp-type terminal which is suitable for specification.

UPS side	Specification			Connect with
Input and output terminal block	Terminal marking	Connection	Figuration	Input power supply and output system
	L/R	AC input (un-grounding side)	5 pole screw terminal (M6)	
	N/S	AC input (grounding side)		
	l/U	AC output (un-grounding side)		
	n/V	AC output (grounding side)		
	PE(G)	Ground (protective grounding)		

- **Connecting the input and output cable**

Remove the terminal block cover on the back of the UPS, and connect the AC output cable to the output terminal block. And confirm that the ground of an input side is connected.

Finally, connect the AC input cable to the input terminal block.

3.3 Interface Port

The interface port (D-sub 9 pins) is mounted on the back of the UPS and can take out the following signals. Use as necessary.

- **CN1 (No-voltage contact signal interface)**

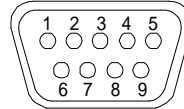

D-sub 9 pins, male
(3mm screw)

Pin No.	Classification of signal	Name of signal	Content
1-4	“Open” at operation	UPS failure signal	It is the no-voltage contact signal which operates when the abnormalities occur inside the UPS, when the abnormalities occur in the battery, or when the recommendation time of battery replacement comes.
1-6	“Close” at operation		
2-5	“Open” at operation	Input power supply abnormal signal	It is the no-voltage contact signal which is outputted when the abnormalities, such as the power failure, occur at an input power supply. (In the power failure for 1.5 seconds or less, it does not operate.)
2-7	“Close” at operation		
3-9	“Open” at operation	Battery voltage drop signal	It is the no-voltage contact signal which is outputted approximately 2 minutes before (at the rated load) the end of battery discharge during the battery operation.
3-8	“Close” at operation		

Use the contact output in the range of the voltage and current in the following graph.

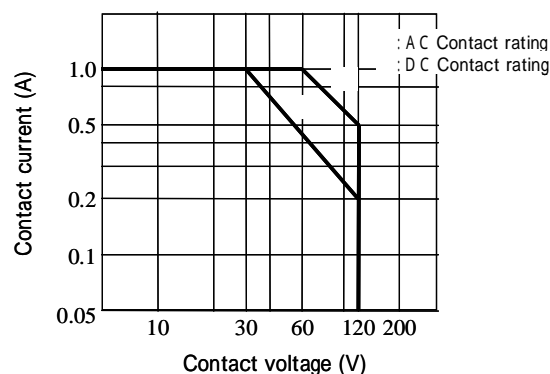

● **CN2 (RS-232C interface)**

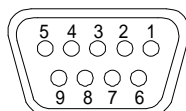

D-sub 9 pins, female
(#4-40 inch screw)

Pin No.	Classification of signal	Name of signal	Content
2-3	“Close” at operation	Input power supply abnormal signal (*1)	It is the no-voltage contact signal which is outputted when the abnormalities, such as the power failure, occur at an input power supply. (In the power failure for 1.5 seconds or less, it does not operate.)
1-3	“Close” at operation	Battery voltage drop signal (*1)	It is the no-voltage contact signal which is outputted approximately 2 minutes before (at the rated load) the end of battery discharge during the battery operation.
8-7	AC output stop at ‘H’ signal reception	UPS automatic shutdown signal (*2)	It is the signal which inputs into the UPS when stopping the AC output of the UPS. (1) The stop of the AC output is possible only during the battery operation. (2) Input this signal (5 to 25 VDC) approximately 0.6 seconds or more.
6-7	RS-232C serial signal (*3)	Serial data input (RX)	[Communication system] Baud rate : 2400 bps
9-7		Serial data output (TX)	Data length : 8 bits
7		Signal ground (SG)	Stop bit : 1 bit Parity : non Character type : ASCII

- *1 Refer to the graph of the previous page for contact capacity.
When using the UPS monitoring function (using the above contact signal) preinstalled in the following OS, contact your maintenance staff, since the dedicated RS-232C cable for contact signal which corresponds to each OS is needed separately. For more detail on the UPS monitoring function preinstalled in each OS, refer to an instructions manual, an on-line manual, etc. of each OS.
- Windows NT/2000/XP:FiFH/WS9 (RS-232C cable)
- *2 In the case of Windows 2000 and XP, although the shutdown of OS can be performed during the power failure, a subsequent UPS automatic shutdown cannot be performed.
- *3 When performing the RS-232C serial communication, contact your maintenance staff, since the RS-232C cable is needed separately.
- FiFA/WS9 (RS-232C cable)

3.4 Setting up the Output Voltage

This UPS can change the rated output voltage by the switch of voltage setting on the back of the UPS.

 Caution	
Damage	<p>Confirm that the voltage set up by the switch of voltage setting is within the range of input voltage of the connection device.</p> <p>There is fear of damaging the connection device.</p> <p>Do not operate the switch of voltage setting during operation of the UPS.</p> <p>There is fear of damaging the connection device. And even if operating the switch during operation of the UPS, the output voltage cannot be changed.</p>

Important	
<p>Do not use 5 to 9 of the switch of voltage setting.</p> <p>It becomes impossible for the UPS to start up normally.</p>	

● The setup procedures of the rated output voltage

1. Turn off the connection device.
2. Press the RUN/STOP switch on the front of the UPS for approximately 1 second. The buzzer will sound if the switch is received.
3. An output stops.
The RUN LED (green) on the front of the UPS blinks slowly (in the cycles of approximately 1.6 sec.).
4. Turn off the input breaker on the back of the UPS.
5. After confirming that all LEDs on the front of the UPS have gone out, operate the switch of voltage setting on the back of the UPS. The rated output voltage corresponding to a setup of the switch of voltage setting is shown below.

Setup of the switch of voltage setting	Rated output voltage
0	100 VAC
1	105 VAC
2	110 VAC
3	115 VAC
4	120 VAC
5-9	They are not used.

6. Connect the UPS to an input power supply and the connection device.
The RUN LED (green) on the front of the UPS blinks slowly (in the cycles of approximately 1.6 sec.).

3 Installation

7. Press the RUN/STOP switch on the front of the UPS for approximately 1 second. The buzzer will sound if the switch is received.
8. AC voltage set up is outputted from the output terminal block. The RUN LED (green) on the front of the UPS lights up.
9. Turn on the connection device, if the normal operation is started with the rated voltage set up.

4 Running

4.1 Turning on the UPS

⚠ Caution

Damage Confirm that the voltage set up by the switch of voltage setting is within the range of input voltage of the connection device.
There is fear of damaging the connection device.

- **Confirming cable connection**

1. Confirm that the UPS is connected to an input power supply and the connection device.
Turn on the input breaker on the back of the UPS.
The RUN LED (green) on the front of the UPS blinks slowly (in the cycles of approximately 1.6 sec.).

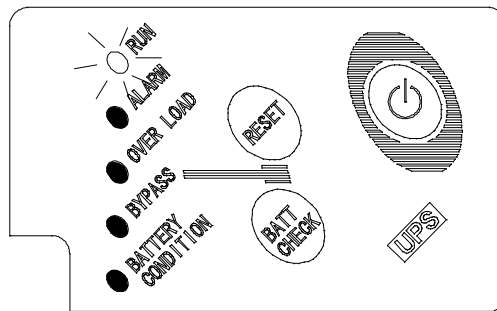

 If the UPS is not connected:
Refer to Chapter 3.2 “Connecting the Cable”.

● Turning on the UPS

2. Press the RUN/STOP switch on the front of the UPS for approximately 1 second. The buzzer will sound if the switch is received.

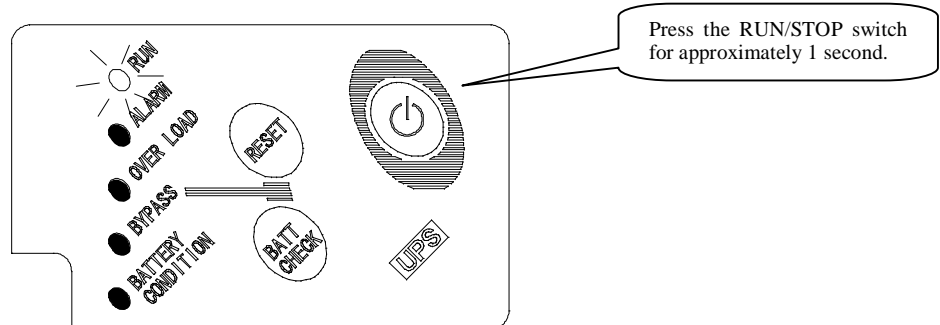

3. AC voltage is outputted from the output terminal block. The RUN LED (green) on the front of the UPS lights up. The BATTERY CONDITION LED (green) on the front of the UPS indicates the amount of battery charge according to the sort of lighting.

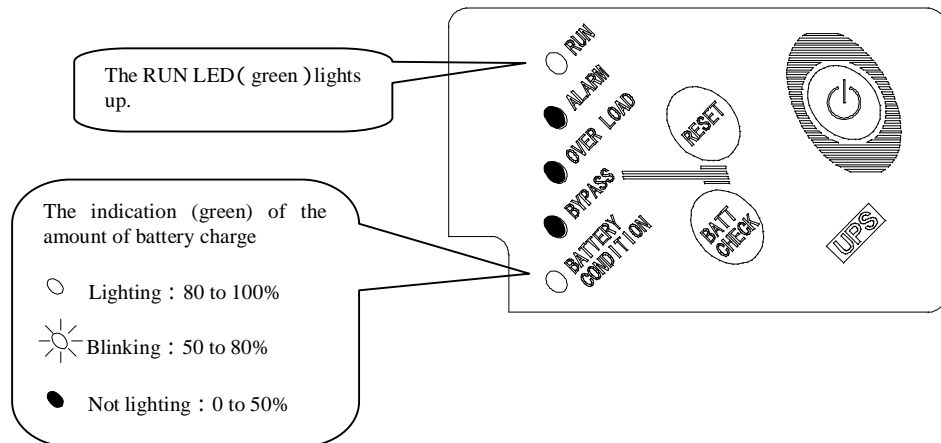

4. The battery check is performed automatically.
The BATTERY CONDITION LED (orange) on the front of the UPS blinks (in the cycles of approximately 1.6 sec.).

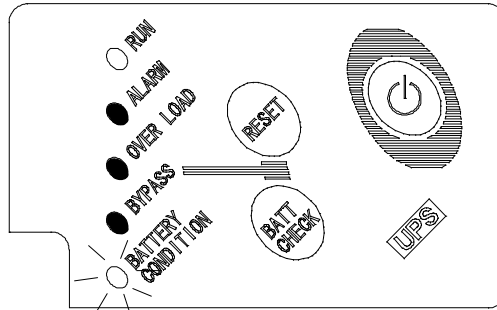

5. The battery check is performed for approximately 5 seconds. Then, if the battery is normal, the BATTERY CONDITION LED (green) on the front of the UPS indicates the amount of battery charge again, and the UPS returns to the normal operation.

 If the normal operation is not started:
Refer to Chapter 6 “Troubleshooting”.

- **Turning on the connection device**

6. Turn on the connection device if the normal operation is started.

4.2 Turning off the UPS

Also when the rolling blackouts are performed, be sure to perform the following operation. (For details, refer to Chapter 5.2 “Caution and Measures for the Rolling Blackouts”)

 Caution	
Damage	<p>When turning off the input breaker on the back of the UPS, confirm that the RUN LED (green) is blinking slowly (in the cycles of approximately 1.6 sec.).</p> <p>If the breaker of the distribution board is turned off or the input breaker on the back of the UPS is turned off, without turning off the UPS, the internal battery will be discharged, since it will be in the same state as a power failure.</p> <p>There is fear of the battery damage or a shortening of a cycle of battery replacement.</p>

- **Turning off the connection device**
 1. Turn off the connection device.

- **Turning off the UPS**
 2. Press the RUN/STOP switch on the front of the UPS for approximately 1 second.
The buzzer will sound if the switch is received.

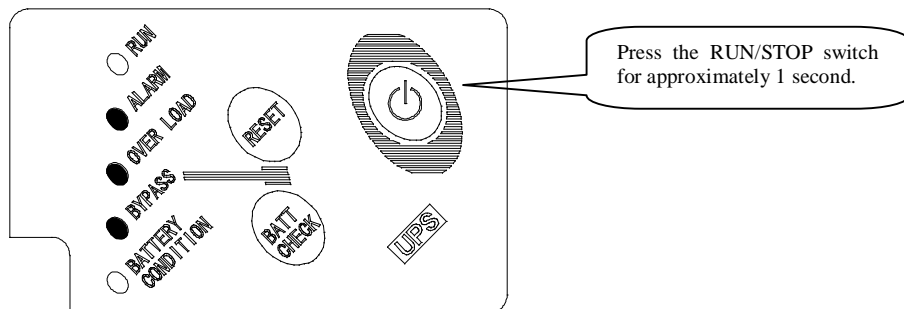

- An output stops.
The RUN LED (green) on the front of the UPS blinks slowly (in the cycles of approximately 1.6 sec.).

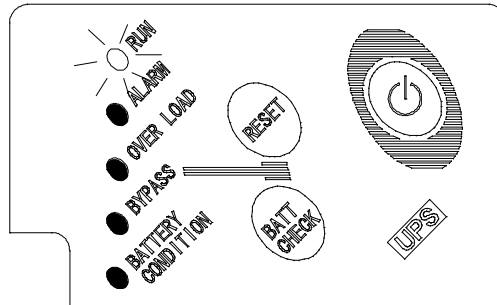

 If an output does not stop normally:
Refer to Chapter 6 “Troubleshooting”.

- Turn off the input breaker on the back of the UPS.

5 Inspection

5.1 Care and Daily Inspection

In order to use the UPS safely over the long term, perform the following care and daily inspection regularly.

Warning

Electric shock	Do not remove the cover of the UPS. Since there are some portions with high voltage in the inside of the UPS, there is fear of an electric shock.
-----------------------	---

Caution

Electric shock	When inspecting or maintaining the connection device (a device getting connected to the UPS) or the UPS, turn off the connection device and the UPS. And turn off the input breaker on the back of the UPS, and cut off connection with AC input terminal (R, S).
-----------------------	--

There is fear of an electric shock.

Only maintenance personnel must perform the maintenance other than daily inspection, such as the replacement of battery and cooling fan.

There is fear of an electric shock.

Damage	When turning off the input breaker on the back of the UPS, confirm that the RUN LED (green) is blinking slowly (in the cycles of approximately 1.6 sec.).
---------------	--

If the breaker of the distribution board is turned off or the input breaker on the back of the UPS is turned off, without turning off the UPS, the internal battery will be discharged, since it will be in the same state as a power failure.

There is fear of the battery damage or a shortening of a cycle of battery replacement.

- **How to care for the UPS**

1. Turn off the UPS after turning off the connection device, and remove the dust adhering to the vent hole and cooling fan of the UPS with a cleaner, etc.
2. Wipe the surface of the UPS with a dry and soft cloth.

- **Daily inspection**

- Confirm that the dust is not adhering to the vent hole and the cooling fan.
 - ☞ When the dust is adhering:
Refer to “How to care for the UPS.”
- Confirm that the surface of UPS and the electric cables are not heating unusually.
 - ☞ When they are heating:
Confirm the state, and contact an agent from which you purchased the UPS, or a maintenance company.
- Confirm that a loud abnormal sound or a nasty smell is not occurring during the operation of the UPS.
 - ☞ When abnormalities have occurred:
Confirm the state, and contact an agent from which you purchased the UPS, or a maintenance company.

5.2 Caution and Measures for the Rolling Blackouts

Important

When using a generator temporarily during the rolling blackouts, use a generator satisfying the following specification.

If connecting a generator not satisfying the following specification to the input part of the UPS, there is a possibility of becoming the cause of the malfunction or damage of the UPS.

- Voltage variation: 85 to 138 VAC
- Frequency variation: within rated frequency $\pm 5\%$ (1Hz/sec.)
- Voltage waveform distortion: within 5%
- Voltage zero-cross condition: Zero-cross must not occur twice or more in 1 cycle.

● Operation before the rolling blackouts



Turn off the connection device and the UPS before performing the rolling blackouts (Note).

1. Turn off the connection device.
2. Press the RUN/STOP switch on the front of the UPS for approximately 1 second. The buzzer will sound if the switch is received.
3. An output stops.
The RUN LED (green) on the front of the UPS blinks slowly (in the cycles of approximately 1.6 sec.).

If the rolling blackouts are performed without turning off the UPS, the UPS will be in the same state as an ordinary power failure. Electric power is supplied to the connection device from the internal battery of the UPS until the rolling blackouts are completed. Electric power is not supplied to the connection device until an input power supply returns after the electric discharge is completed.

Note) The rolling blackouts mean the blackouts to which the date and hour, such as the safety inspection of electricity, is informed beforehand.

● Operation after the rolling blackouts

1. Confirm that the UPS is connected to an input power supply and the connection device.
The RUN LED (green) on the front of the UPS blinks slowly (in the cycles of approximately 1.6 sec.).
2. Press the RUN/STOP switch on the front of the UPS for approximately 1 second. The buzzer will sound if the switch is received.
3. AC voltage is outputted from the output terminal block, and the RUN LED (green) on the front of the UPS lights up.
4. Turn on the connection device if the normal operation is started.
 -  For details, refer to Chapter 4.1 “Turning on the UPS”.
 -  When a warning beep sounds:
Refer to Chapter 6.1 “If a Warning Beep Sounds”.

5.3 Inspecting the Battery (Battery Check)

Inspection of the battery is performed using a battery check function. There are two kinds of battery check functions, an automatic check and a manual check.

The manual check is not necessary ordinarily since the automatic check is performed while the UPS is operating.

Automatic check is performed in the following cases:

- When the operation of UPS is started up
- Every two weeks in an operation continuation state
- When having switched to the normal operation from the bypass operation

Perform manual check in the following cases:

- When a warning beep sounds due to the abnormalities in a battery
- When performing the battery check other than the automatic check

Important

Do not perform the battery check in succession.

When the battery check is performed, the internal battery is actually discharged and the voltage is checked.

If the battery check is performed in succession, there is fear of the battery damage or a shortening of a cycle of battery replacement.

● Confirming the state of the UPS

1. Confirm that the UPS is operating normally.

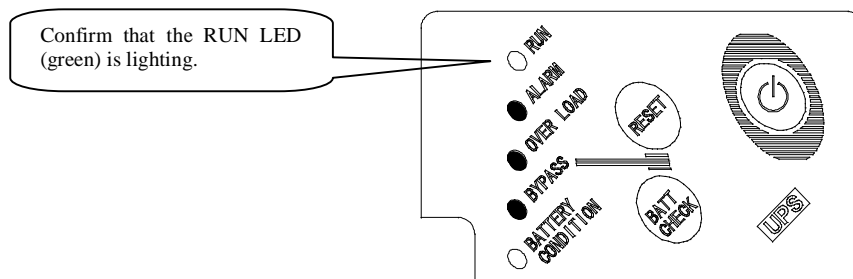

- ☞ When the UPS is in a stop state (all LEDs on the front of the UPS are going out):
Turn on the UPS, and proceed to Procedure 2.
For details, refer to Chapter 4.1 “Turning on the UPS”.
- ☞ When the normal operation cannot be confirmed in states other than a stop:
Proceed to Procedure 2 after dealing with the trouble, with reference to Chapter 6 “Troubleshooting”.

- Using the manual check function

2. Press the BATT CHECK switch on the front of the UPS for approximately 2 seconds.

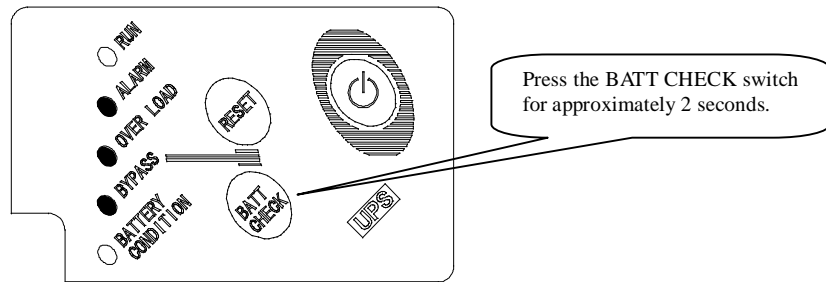

A buzzer sounds and the BATTERY CONDITION LED (orange) blinks (in the cycles of approximately 1.6 sec.).

A buzzer sounds again approximately 5 seconds later and the battery check is completed.

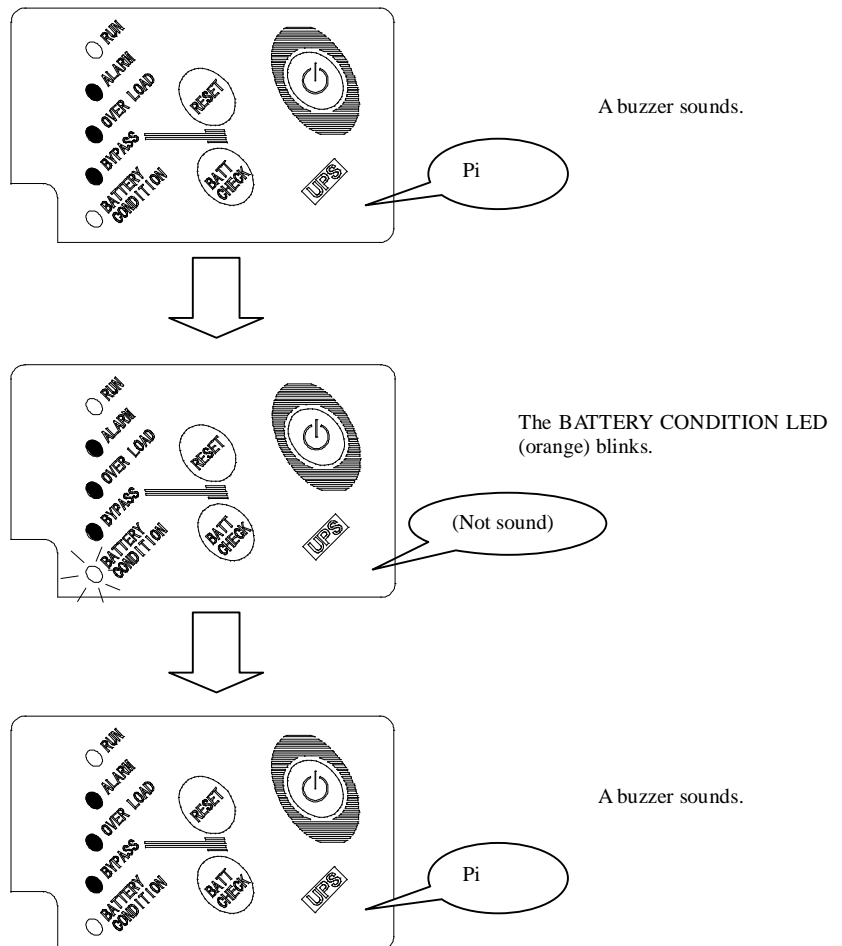

3. As a result of the battery check, the UPS will be in the following state.

☞ If the battery is fully charged:



The RUN LED (green) on the front of the UPS lights up, and the UPS returns to the normal operation.

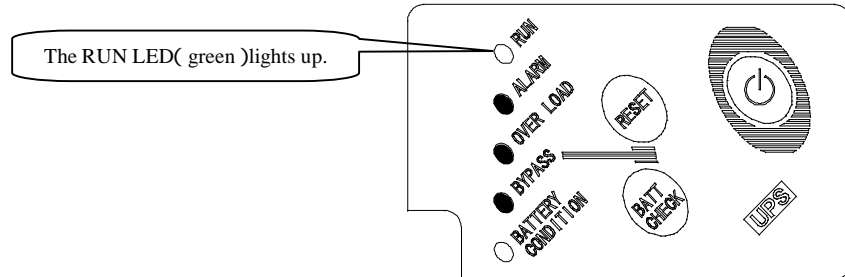

☞ If the battery is not fully charged:



A warning beep sounds and the BATTERY CONDITION LED (orange) on the front of the UPS blinks. Proceed to Procedure 4.

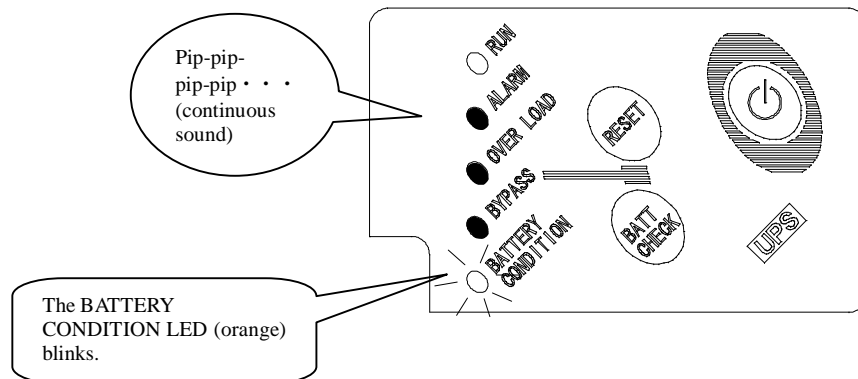

● **Charging the battery**

4. Put out the BATTERY CONDITION LED (orange) by pressing the RESET switch on the front of the UPS for approximately 3 seconds, and operate the UPS 12 hours or more to charge the battery.



When pressing the RESET switch, once the BATTERY CONDITION LED (orange) on the front of the UPS goes out, and is switched to the indication (green) of the amount of battery charge.

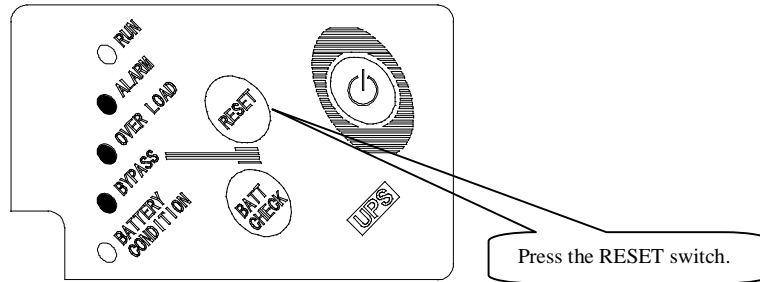

Remarks. In this state, even if a power failure occurs, the battery operation may not be performed.

5. Return to Procedure 2, and perform the battery check again manually.

☞ When the UPS will be in the state of Procedure 3 “If the battery is not fully charged” again:
The battery is out of order (end of battery life). Replace the battery.
For details, refer to Chapter 7.1 “Replacing the Battery”.

6 Troubleshooting

6.1 If a Warning Beep Sounds

1. Confirm the state of LED on the front of the UPS, and the type of a warning beep.
2. Refer to the “Operation mode list”, and deal with it according to directions.

If the UPS is not connected to an input power supply, connect. For details, refer to Chapter 3.2 “Connecting the Cable”.



How to stop a warning beep:

A warning beep can be stopped by pressing the RESET switch on the front of the UPS for approximately 1 second. (Note)

However, if a warning beep does not stop even if pressing the RESET switch, stop a warning beep by the following procedures. For details, refer to Chapter 4.2 “Turning off the UPS”.

- (1) Turn off the connection device.
- (2) Press the RUN/STOP switch on the front of the UPS for approximately 1 second.
- (3) An output stops.
The RUN LED (green) on the front of the UPS blinks slowly (in the cycles of approximately 1.6 sec.).
- (4) Turn off the input breaker on the back of the UPS.

Note) In the output overload state, even if pressing the RESET switch, a warning beep does not stop. Reduce the capacity of the connection device to less than the rated value of the UPS.



6.2 Operation Mode List

When it seems that the abnormalities have occurred inside the UPS or the connection device has stopped, confirm the LED and a warning beep by the following lists, and deal with the trouble in accordance with the remarks in the "Operation mode list".

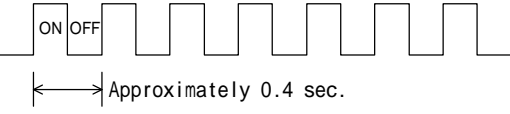
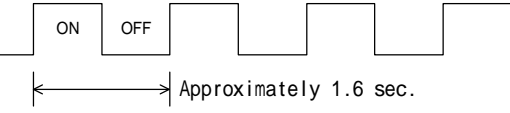
- **Types of blink of LED (The symbols correspond to the symbols in the "Operation mode list".)**

Symbol	Blink pattern
(a) Fast blink (in the cycles of approximately 0.4 sec.)	
(b) Slow blink (in the cycles of approximately 1.6 sec.)	

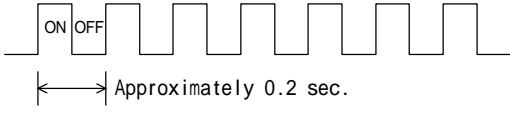
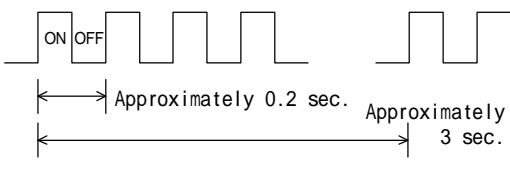
- **Types of the warning beep (The symbols correspond to the symbols in the "Operation mode list".)**

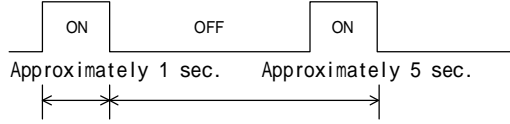

Symbol	Warning beep
(1) Pip-pip-pip-pip . . . (continuous sound)	
(2) Pip-pip-pip-pip (a stop for approximately 2 sec.) Pip-pip-pip-pip (four times every approximately 3 sec.)	
(3) Pi— (continuance)	
(4) Pi— (a stop for approximately 4 sec.) Pi—	



● Operation mode list

- Symbols of LED: ○ Lighting ● Not lighting ☀ Blinking
- The BATTERY CONDITION LED (green) indicates the amount of battery charge according to the sort of lighting as follows:
 - (Not lighting)..... 0 to 50% : The battery is not fully charged. Even if a power failure occurs, the UPS may not be able to back up.
 - ☀ (Blinking)..... 50 to 80% : The battery is charged to some extent. However, an adequate backup time cannot be assured.
 - (Lighting)..... 80 to 100% : The battery is fully charged. There is backup time at full.





No.	LED					Warning beep	Operational status	Remarks
	RUN (green)	ALARM (orange)	OVER LOAD (orange)	BYPASS (orange)	BATTERY CONDITION (green/orange)			
1	Lighting ○	●	●	●	Indication of the amount of battery charge (green)	-	Normal operation	The UPS is operating normally.
2	●	●	●	●	●	-	Stopping (without an input power supply)	The output of the UPS is stopping. If an input power supply returns, the UPS will become the stopping (No.3). If the UPS does not become the stopping (No.3) even if an input power supply returns, check whether or not the input breaker has tripped. If the breaker has tripped, reset it. Nevertheless, if the UPS does not become the stopping (No.3), contact an agent from which you purchased the UPS, or a maintenance company. When the UPS stopped since the input power failure had continued and electric discharge of a battery had been completed, the UPS will return to the normal operation (No.1) automatically if an input power supply returns.
3	(b) Slow blink ☀	●	●	●	●	-	Stopping (with an input power supply)	The output of the UPS is stopping. The UPS will return to the normal operation (No.1) by pressing the RUN/STOP switch for approximately 1 second.

6 Troubleshooting

No.	LED					Warning beep	Operational status	Remarks
	RUN (green)	ALARM (orange)	OVER LOAD (orange)	BYPASS (orange)	BATTERY CONDITION (green/orange)			
4	●	Lighting ○	●	Lighting ○	●	(1)	Bypass operation due to UPS failure	The UPS became the failure state and switched to the bypass operation. Evacuate important connection device from the UPS. In this state, even if an input power failure occurs, the battery operation cannot be performed. Confirm ambient temperature and ventilation, and press the RESET switch on the front of the UPS for approximately 3 seconds after approximately 10 minutes have passed. If there is no problem, the UPS will return to the normal operation (No.1). If the ALARM LED does not go out or lights up again, even if the above operation is performed, contact an agent from which you purchased the UPS, or a maintenance company.
5	Lighting ○	●	●	●	Indication of the amount of battery charge (green)	(3)	Abnormality in cooling fan	Abnormalities have occurred in the cooling fan. If this state continues for approximately 2 minutes or the inside temperature of the UPS rises, the UPS will become the failure state of No.4.
6	●	●	●	(b) Slow blink 	●	-	Manual bypass operation	The UPS has been switched to the bypass operation manually. In this state, even if an input power failure occurs, the battery operation cannot be performed.
7	(b) Slow blink 	(a) Fast blink 	●	●	●	(1)	Input error at startup	Since the abnormalities have occurred at an input power supply, the UPS cannot be started up. Stop the UPS once, and restart after confirming that an input power supply is within the range of the following conditions. Input voltage: 85 to 138 VAC Input frequency: 47.5 to 52.5 Hz or 57 to 63 Hz
8	Lighting ○	●	Lighting ○	Lighting ○	●	(1)	Bypass operation due to an output overload during the normal operation	Since the capacity of the connection device exceeded the rated value and the UPS became the overload state, the UPS has switched to the bypass operation automatically. Reduce the capacity of the connection device to less than the rated value of the UPS. If the capacity of the connection device become below the rated value, the UPS will return to the normal operation (No.1). In the state of the continuation of overload, even if pressing the RESET switch, the warning beep does not stop. Although it may become the overload temporarily by inrush current at the time of a load injection.

No.	LED					Warning beep	Operational status	Remarks
	RUN (green)	ALARM (orange)	OVER LOAD (orange)	BYPASS (orange)	BATTERY CONDITION (green/orange)			
9	●	●	Lighting ○	(b) Slow blink 	●	(1)	Output overload during the bypass operation	During the bypass operation, the capacity of the connection device exceeds the rated value. Reduce the capacity of the connection device to less than the rated value of the UPS. In this state, even if pressing the bypass switch (pressing the RESET switch and the BATT CHECK switch for approximately 3 seconds simultaneously), the UPS will not return to the normal operation (No.1).
10	Lighting ○	●	Lighting ○	●	Indication of the amount of battery charge (green)	(1)	Output overload during the battery operation	During the battery operation, the capacity of the connection device exceeds the rated value. Reduce the capacity of the connection device to less than the rated value of the UPS. If this state continues for 100 seconds, the UPS will stop. Evacuate important connection device from the UPS.
11	Lighting ○	●	●	●	Indication of the amount of battery charge (green)	(2)	Battery operation	Since the abnormalities occurred at an input power supply, the UPS started to supply the electric power to the connection device from the battery. It is not necessary to deal with it especially. If an input power supply returns, the UPS will return to the normal operation (No.1) automatically.
12	Lighting ○	●	●	●	Indication of the amount of battery charge (green)	(1)	Battery voltage drop due to continuing the battery operation	The battery voltage dropped since the battery operation has continued. In the rated load, the battery operation will be completed approximately 2 minutes later. Evacuate important connection device from the UPS. If an input power supply returns, the UPS will return to the normal operation (No.1) automatically.
13	Lighting ○	●	●	●	(b) Slow blink (orange) 	(4) (at the manual check)	Battery checking	The battery check is performed. At the manual battery check, a buzzer sounds at the start and end of the battery check. After the battery check is performed for approximately 5 seconds, the UPS will return to the normal operation (No.1) if there is no problem.
14	Lighting ○	●	●	●	(a) Fast blink (orange) 	(1)	Battery check error	There is possibility that the battery is not fully charged. Perform the battery check manually after operating the UPS 12 hours or more to charge the battery. Since an adequate backup time cannot be assured, evacuate important connection device from the UPS. If the UPS becomes this state again, the battery is out of order. Since it is necessary to replace the battery, contact an agent from which you purchased the UPS, or a maintenance company.

6 Troubleshooting

No.	LED					Warning beep	Operational status	Remarks
	RUN (green)	ALARM (orange)	OVER LOAD (orange)	BYPASS (orange)	BATTERY CONDITION (green/orange)			
15	Lighting ○	●	●	●	Lighting (orange) ○	(1)	End of battery life	The recommendation time of battery replacement has come. Since it is necessary to replace the battery, contact an agent from which you purchased the UPS, or a maintenance company. Although the alarm (indication and warning beep) can be stopped by pressing the RESET switch for 3 seconds, the alarm (warning beep) is issued again 24 hours later or at the restart. When only the warning beep is stopped by pressing the RESET switch 1 second or more, the alarm (warning beep) of the end of battery life will be issued again at the automatic battery check which is performed every two weeks.
16	(b) Slow blink 	(a) Fast blink 	●	●	●	(1)	Setting error of rated output voltage	A setup of the switch of voltage setting on the back of the UPS is wrong. Use 0 to 4 of the switch of voltage setting. For details on a setup, refer to Chapter 3.4 "Setting up the Output Voltage".
17	(b) Slow blink 	●	●	●	(b) Slow blink (orange) 	-	Waiting for a restart	The output of the UPS has stopped by setup of the RS-232C communication using the connector for RS-232C on the back of the UPS. After a time specified at the setup passes, the UPS will be started up automatically, and return to the normal operation (No.1). Also, the UPS can be started up with the RUN/STOP switch.

7 Maintenance

7.1 Replacing the Battery

- **Timing of the battery replacement**

 Caution	
Damage	Replace the battery periodically.
	If continuing to use the UPS that the battery life ended, there is fear of a leak of battery and a smoke.

In the following cases, it is the end of battery life. Replace the battery.

- When the BATTERY CONDITION LED (orange) on the front of the UPS lights up and a warning beep sounds

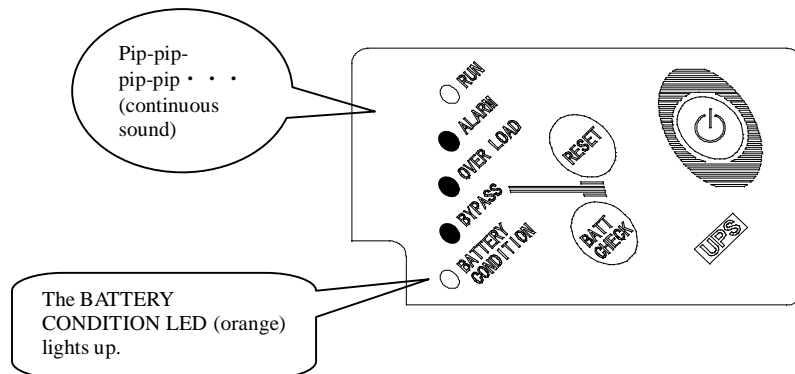

- When the backup time of the battery has been lowered to 3 minutes or less (at the rated load)

Battery life is influenced greatly by ambient temperature and the conditions of connection device. If using the UPS in the standard environment and conditions (an ambient temperature of 25 degrees C, and the rated load), replace the battery in approximately 3 years.

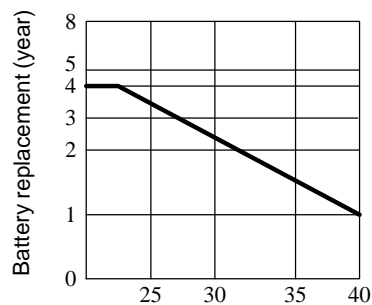

Ambient temperature of the UPS ()
Relation between the ambient temperature and the cycle of battery replacement

● The method of battery replacement

 Caution	
Electric shock	<p>Only maintenance personnel must perform the battery replacement.</p> <p>There is fear of an electric shock.</p>
Damage	<p>Replace the battery with one specified by our company and a new one.</p> <p>If using the un-specified battery or mixing an old battery and a new battery, it becomes the cause of failure and trouble of the UPS.</p>

Important
<p>The disposal of used battery has legal restrictions.</p> <p>Commission industrial waste disposal contractor, or consult with an agent from which you purchased the UPS, or a maintenance company.</p>

The battery of this UPS can be replaced (hot-swap) without turning off the UPS and connection device (Note). For details, consult with an agent from which you purchased the UPS, or a maintenance company.

Note) The UPS performs the bypass operation during hot swapping. In the state of the bypass operation, even if the abnormalities, such as a power failure, occur at an input power supply, the battery operation cannot be performed.

Use the battery shown in the following list. For the method of purchasing the battery unit, consult with an agent from which you purchased the UPS, or a maintenance company.

UPS model	Arrangement model	Type of battery unit	Number of units (Note) (per UPS)	Battery unit	
				Mass (a unit)	Battery capacity
M-UPS050 AD1C	Battery for M-UPS 050AD1B	RRABU-GX14	4 units	Approximately 9kg	12V, 9Ah × 3
M-UPS050 AD1B					

Note) It is necessary to replace the battery by the unit.

- **Disposal and storage of battery**

- Pay enough attention to disposal and storage of the battery. When disposing of the used battery, dispose of it separately from a dry cell, etc., sticking the insulating tape on the terminal of battery to prevent a short circuit.
- This UPS uses the small sealed lead storage battery. The small sealed lead storage battery uses expensive and rare resources. However, these precious resources are able to recycle. Cooperate in recycling without disposing of the used battery. If you have any questions, consult with an agent from which you purchased the UPS, or a maintenance company.



This mark is the recycle mark of small sealed lead storage battery.

7.2 Replacing the Cooling Fan

- **Timing of the cooling fan replacement**

Important
<p>Replace the cooling fan periodically.</p> <p>If continuing to use the UPS that the fan life ended, there is a possibility that the inside temperature of the UPS may get out of the rated specification.</p>

In the following cases, it is the end of cooling fan life. Replace the cooling fan.

- When the ALARM LED (orange) and the BYPASS LED (orange) light up, after a warning beep sounded for 120 seconds

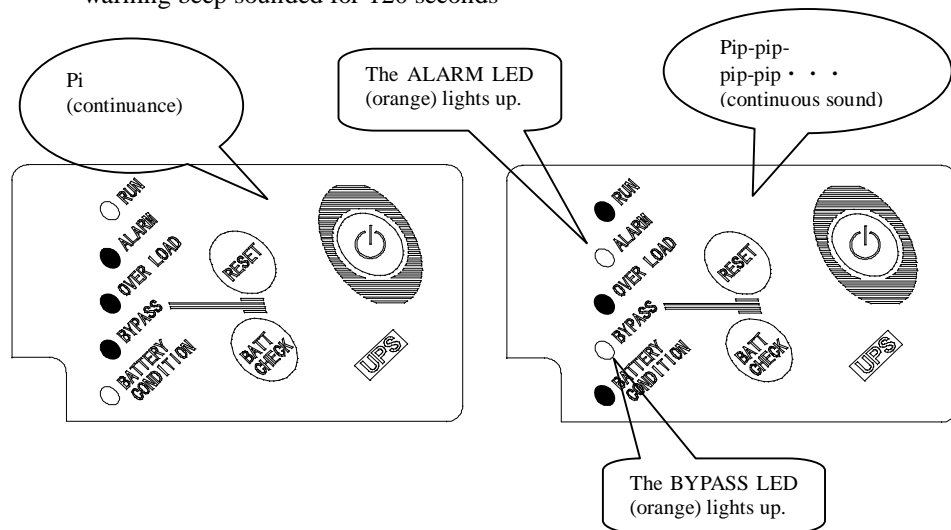

- At the second battery replacement (at an ambient temperature of 25 degrees C and approx. 6th year in cases of the rated load)

It is necessary to replace the cooling fan with new one periodically, since the cooling fan has a life by wear of the bearing. However, since the life of cooling fan may become short according to the use environment, replace the cooling fan early.

- **The method of cooling fan replacement**

 Caution	
Electric shock Injury	<p>Put neither a stick nor a finger into the cooling fan or the vent hole.</p> <p>There is fear of an electric shock or an injury.</p>
Electric shock	<p>Only maintenance personnel must perform the cooling fan replacement.</p> <p>There is fear of an electric shock.</p>

The cooling fan of this UPS can be replaced (hot-swap) without turning off the UPS and connection device (Note). For details, consult with an agent from which you purchased the UPS, or a maintenance company.

Note) The hot-swap should be performed in a short time. The UPS starts the bypass operation if the temperature inside the UPS rises (out of the rated specification). In the state of the bypass operation, even if the abnormalities, such as a power failure, occur at an input power supply, the battery operation cannot be performed.

Use the following cooling fan. For the method of purchasing the cooling fan, consult with an agent from which you purchased the UPS, or a maintenance company.

Cooling fan type for replacement:

Fan for M-UPS050AD1B (RRAF-R1 × 2 / RRAF-GX12 × 2)

7.3 When Not Using the UPS (Storage)

● Work before storage

Important
<p>Do not store the UPS in the following places:</p> <ul style="list-style-type: none"> • In an outdoor location • A place exposed to the elements • An extremely humid place and a dusty place • A place with corrosive gas or salinity • A place subjected to direct sunlight • A place near sparks or heating element • An extremely hot or cold place or place where the temperature fluctuates greatly • A place where vibration and a shock are added

1. Perform the battery check using the manual battery check function after operating the UPS 12 hours or more to charge the battery.
For details, refer to Chapter 5.3 “Inspecting the Battery (Battery Check) ”.
The period that can store the battery used for this UPS is approximately 2 months from the state charged fully.
2. Turn off the UPS after turning off the connection device, and turn off the input breaker on the back of the UPS.
Remove all of the connections of input and output terminal.
For details, refer to Chapter 4.2 “Turning off the UPS”.
3. Put the UPS in a box (the box, etc. which was packing the UPS) and store it.

● If a storage period exceeds two months

Important
<p>If the UPS is not used for a long time, charge the battery every two months.</p> <p>Charge the battery by operating the UPS 12 hours or more every two months, and after charging the battery, perform the battery check. If the UPS is left without operating for a long time, there is a possibility that the UPS get unusable since the battery becomes an over-discharge state due to self-discharge.</p>

Perform the battery check using the manual battery check function after operating the UPS 12 hours or more every two months to charge the battery.
For details, refer to Chapter 5.3 “Inspecting the Battery (Battery Check) ”.
Even if the UPS is not used, the battery is discharged by itself inside the UPS. If the UPS is left two months or more, there is a possibility that the UPS get unusable since the battery becomes an over-discharge state.

8 Appendix

8.1 Rated Specification

Model	M-UPS050AD1C	M-UPS050AD1B	
Rating capacity	5000VA/4000W		
Voltage	100/105/110/115/120V \pm 2%		
Frequency	50/60Hz (automatic changeover inside the UPS)		
Frequency accuracy	At the normal operation	Depend on input frequency	
	At the battery operation	Within \pm 0.1%	
Number of phase	Single-phase two-wire (with a ground terminal)		
Load condition	Linear load or rectified load with a crest factor of up to three times		
Voltage waveform distortion factor	At the resistance load:	4% or less	
	At the rectified load:	6% or less	
Overcurrent protection	Effective value:	100% or more	
	Peak value:	300% or more of rated effective value (bearing the load of the crest factor of three)	
Grounding system	Un-grounding		
Straightforward bypass circuit	Thyristor system (changeover time: without instantaneous power interruption) Changeover is impossible at the time of a power failure and overload.		
AC input	Voltage *1	85 to 138V	
	Frequency	50/60Hz \pm 5%	
	Number of phase	Single-phase two-wire (with a ground terminal)	
	Capacity	5000VA or less	
	Grounding system	Un-grounding or single-line grounding	
	Power factor	0.97 or more (at the rated operation)	
	Input harmonic current	Based on IEC61000-3-12	
Battery	Type	Small sealed lead storage battery (long-life battery)	
	Backup time *2 (initial value)	Approximately 6 minutes (4000W)	
	Nominal voltage	72V	
Others	Ambient temperature	0 to +40°C	
	Relative humidity	20 to 95% (no condensation)	
	Noise	55dB(A) max. (at 1m from the front of the UPS)	
	Cooling method	Forced air cooling	

8 Appendix

Model		M-UPS050AD1C	M-UPS050AD1B
Outside dimension W × D × H		240 × 700 × 514mm	240 × 700 × 434mm
Mass		84 kg (without battery: 48 kg)	78 kg (without battery: 42 kg)
Standard		UL1778 (-U, -UC type)	
Applicable standard		VCCI CLASS A, In conformity with EN62040 (-UC type)	
External connection	Input	Terminal block (L/R, N/S : M6 screws)	
	Output	Terminal block (I/U, n/V : M6 screws)	
	Ground	Terminal block (PE(G) : M6 screws)	

*1 Operation of UPS according to an input voltage

Low voltage detection : 77V return : 82V

Overvoltage detection : 148V return : 142V

*2 The backup time is the test result and is not a guaranteed value.

8.2 Additional Description for UL Type

IMPORTANT SAFETY INSTRUCTIONS SAVE THESE INSTRUCTIONS

This manual contains important instructions for UPS GX100 series Models that should be followed during installation and maintenance of the UPS and batteries.

Internal battery voltage is 72 V dc.

Models M-UPS050AD1 * -U with suffix. (* : B or C)

This unit intended for installation in a controlled environment and maximum ambient temperature is 25

(temperature controlled, indoor area free of conductive contaminants)

This UPS must be fasten down the floor by L-branckets or stabilizer attached UPS when vertical installation.

This UPS must be fasten down the floor by branckets attached this UPS.

This UPS is intended for use in Japan-domestic.

Need to provide External Disconnect / Overcurrent Protective Device for the AC input and the AC output. -for example ,an UL Listed branch circuit breaker with suitable ratings could provide both functions (disconnect and overcurrent protection).

- A readily accessible disconnect device shall be incorporated in the building installation wiring.
- Circuit Breaker (UL Listed Inverse-time Circuit Breaker) is not provided on the UPS at input side as shipped. This Model must connect Circuit Breakers for use with the UPS. The rated tripping current of the Circuit Breaker (2 pole type) are shown in Table1 and Table2.
- Field wiring connection must be made by a UL and CSA Listed closed-loop terminal connector sized for the wire gauge involved and fully insulated up to terminals. Connector must be fixed using the crimp tool specified by the connector manufacturer. Closed-loop terminal is shown in Table1 and Table2 (made by Japan Solderless Terminal). If can not get these terminals , use the similer terminal.
- Use 75 Copper conductors.
- Wire size and tightening torque are shown in Table1 and Table2. Circuit diagrams are shown by figure 1. UPS must be set up with flexible conduit.

Table 1. Input rating, wire size, torque, external input circuit breaker size

MODEL	INPUT & GROUND				TIGHTENING TORQUE (N · m)	2POLE CIRCUIT BREAKER	
	Vin(V)	Iin(A)	WIRE SIZE AWG	Type of Closed-loop Terminal		V	A
M-UPS050AD1C-U	100/105	50/47.6	4	R14-6	3.0	AC240	70
M-UPS050AD1B-U	110/115	45.5/43.5					
	120	417					

Table 2. Output rating, wire size, torque, external output circuit breaker size

MODEL	OUTPUT				TIGHTENING TORQUE (N · m)	2POLE CIRCUIT BREAKER	
	Vin(V)	Iin(A)	WIRE SIZE AWG	Type of Closed-loop Terminal		V	A
M-UPS050AD1C-U M-UPS050AD1B-U	100/105 110/115 120	50/47.6 45.5/43.5 41.7	4	R14-6	3.0	AC240	70

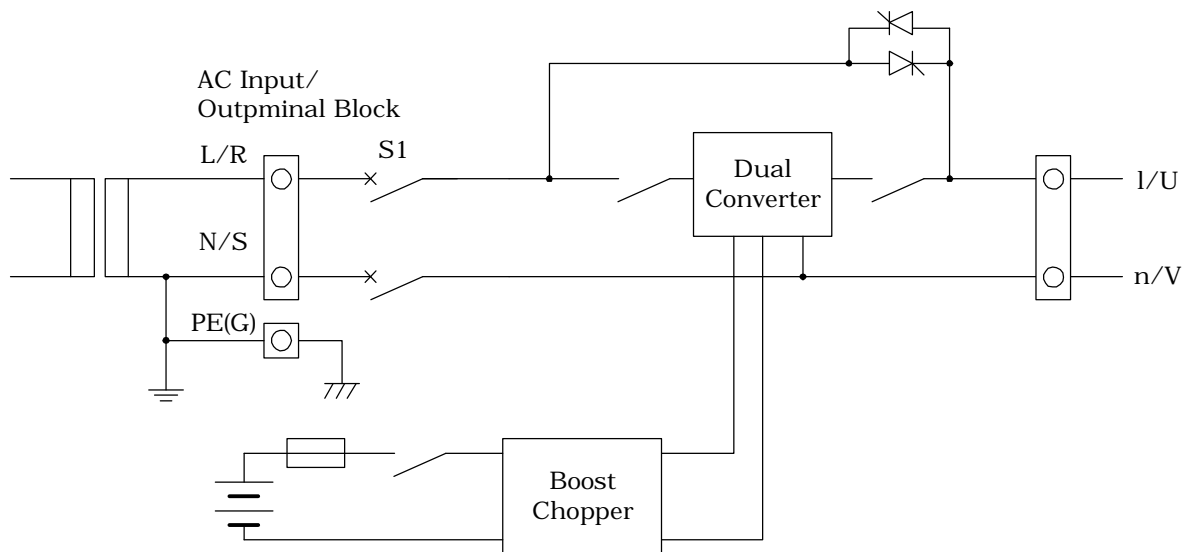

Figure 1 - Circuit diagram of Models M-UPS050AD1C-U or M-UPS050AD1B-U

 **DANGER**

Risk of electric shock
Do not touch uninsulated battery terminal.

 **WARNING**

Risk of electric shock
• Do not remove the cover for any reason. There are no user-serviceable parts inside the UPS. Refer servicing to qualified service personnel.

 **CAUTION**

Don't use this equipment in life support applications where failure of this equipment can reasonably be expected to cause the failure of the life support equipment or to significantly effect its safety or effectiveness.

Risk of explosion if battery is replaced by an incorrect type. Dispose of used batteries according to the instructions.

Replace batteries are only the one designated by our company.

Risk of electric shock

- Battery and cooling fan servicing should be performed by only authorized servicing personnel who were qualified technically. Keep unauthorized personnel away from batteries and cooling fan.
- The UPS has an internal energy source (the battery). The output may be energized when the unit is not connected to an AC power line.
- Terminal marked "PE(G)" is intended for connection of the Protective Earthing (Grounding) conductor(s). This earth connection is essential before connecting supply conductors. Also ensure the reliability of this connection during any servicing, including connection of protective earthing (grounding) conductors to the output (load).
- Capacitor stores hazardous energy. Do not remove cover until 7 minutes after disconnecting all sources of supply.
- If this UPS installs, removes or does any services, be off the external input circuit breaker for disconnecting all sources of supply.

Do not dispose of batteries in a fire. The batteries may explode.

Do not open or mutilate batteries. Released electrolyte is harmful to the skin and eyes. It may be toxic.

A battery can present a risk of electrical shock and high short-circuit current. The following precautions should be observed when working on batteries:

- a) Remove watches, rings, or other metal objects.
- b) Use tools with insulated handles.
- c) Wear rubber gloves and boots.
- d) Do not lay tools or metal parts on top of batteries.
- e) Disconnect charging source prior to connecting or disconnection battery terminals.
- f) Determine if battery is inadvertently grounded.
If inadvertently grounded, remove source from ground.
Contact with any part of a grounded battery can result in electrical shock. The likelihood of such shock can be reduced if such grounds are removed during installation and maintenance (applicable to equipment and remote battery supplies not having a grounded supply circuit).