

Owner's Manual

Ceiling Fan Installation Instructions



Total fan weigh
with light

For 5CLR66XXD Series Fans

READ AND SAVE THESE INSTRUCTIONS

MONTE CARLO
Quality Ceiling fans



Installation

SAFETY TIPS

WARNING: TO REDUCE THE RISK OF FIRE, ELECTRIC SHOCK, OR INJURY TO PERSONS, OBSERVE THE FOLLOWING: READ AND SAVE THESE INSTRUCTIONS

1. Installation work and electrical wiring must be done by qualified person(s) in accordance with applicable codes and standards (ANSI/NFPA 70-1999), including fire-rated construction.
2. Use this unit only in the manner intended by the manufacturer. If you have any questions contact the manufacturer.
3. After making the wire connections, the wires should be spread apart with the grounded conductor and the equipment-grounding conductor on one side of the outlet box and ungrounded conductor on the other side of the outlet box.
4. Before you begin installing the fan, Switch power off at Service panel and lock service disconnecting means to prevent power from being switched on accidentally. When the service disconnecting means cannot be locked, securely fasten a prominent warning device, such as a tag, to the service panel.
5. Be cautious! read all instructions and safety information before installing your new fan. Review the accompanying assembly diagrams.
6. When cutting or drilling into wall or ceiling, do not damage electrical wiring and other hidden utilities.
7. Make sure the installation site you choose allows the fan blades to rotate without any obstructions. Allow a minimum clearance of 7 feet from the floor to the trailing edge of the blade.
8. **WARNING – Risk of fire, electric shock, or personal injury,** The fan in this box may be either directly supported from a structural framing member of a building and/or may be mounted to an outlet box marked acceptable for fan support of 31.8 kg. (70 lbs.) or less. Most outlet boxes commonly used for the support of luminaires may not be acceptable for fan support and may need to be replaced. Consult a qualified electrician if in doubt. Do not bend blade holders during installation to motor, balancing or during cleaning. Do not insert foreign object between rotating blades.
9. Attach the mounting bracket using only the hardware supplied with the outlet box.
10. To reduce the risk of fire or electric shock, do not use this fan with any solid state fan speed control device, or variable speed control.
11. If this unit is to be installed over a tub or shower, it must be marked as appropriate for the application.
12. NEVER place a switch where it can be reached from a tub or shower.
13. The combustion airflow needed for safe operation of fuel-burning equipment may be affected by this unit's operation. Follow the heating equipment manufacturer's guideline safety standards such as those published by the National Fire Protection Association (NFPA), and the American Society for Heating, Refrigeration and Air Conditioning Engineers (ASHRAE) and the local code authorities.
14. Before servicing or cleaning unit, Switch power off at Service panel and lock service disconnecting means to prevent power from being switched on accidentally. When the service disconnecting means cannot be locked, securely fasten a prominent warning device, such as a tag, to the service panel.

TOOLS REQUIRED

Phillips Screwdriver

Wire Cutters

Pliers

Step Ladder



1
Before you begin installing the fan, Switch power off at Service panel and lock service disconnecting means to prevent power from being switched on accidentally. When the service disconnecting means cannot be locked, securely fasten a prominent warning device, such as a tag, to the service panel.

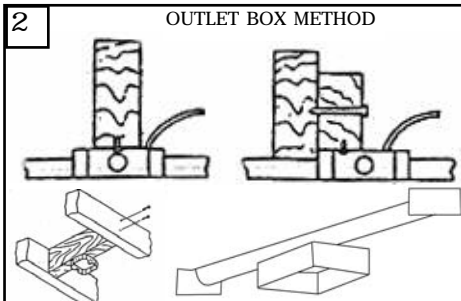

2
Warning-Risk of fire, electric shock, or personal injury. The fan in this box may be either directly supported from a structural framing member of a building and/or may be mounted to an outlet box marked acceptable for fan support of of 31.8 kg (70 lbs) or less. Most outlet boxes commonly used for the support of luminaires may not be acceptable for fan support and may need to be replaced. Consult a qualified electrician if in doubt.



3
Remove Safety bar from mounting bracket by loosening screws, sliding bar to side, and lifting it off the 2 screws.



4
Remove the 4 screws attaching the Mounting neck the mounting plate. Retain the 4 screws for re-assembly.

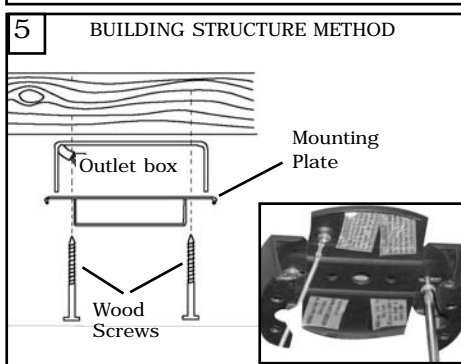

5
Secure mounting plate directly to a joist from the buliding structure via the two knock out holes on the outlet box. Use only the appropriate wood screws and washers included with your fan. Caution: Wood screws must go through into the building joist.



6
Install the mounting Plate to approved fan brace and box combination use only the hardware provided with the fan brace and box.

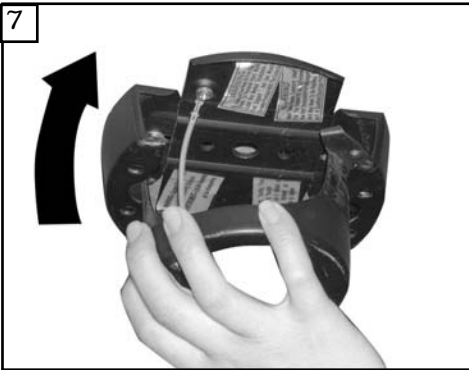

Lift mounting neck to mounting Plate and align screws.

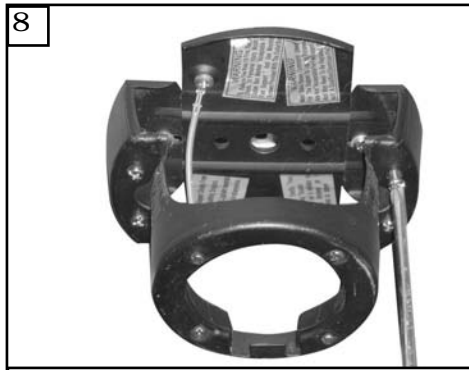

Secure mounting neck to the mounting plate with four screws to become a complete mounting bracket.

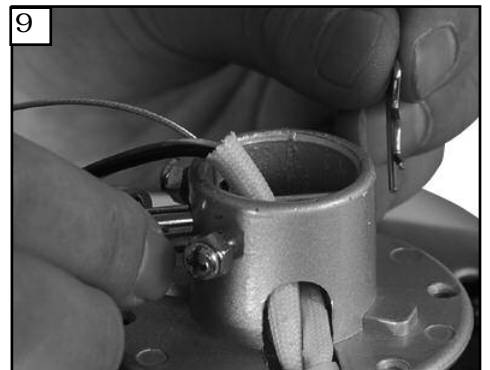

Remove keeper from cross pin and then cross pin from yoke. Replace keeper on cross pin and save.

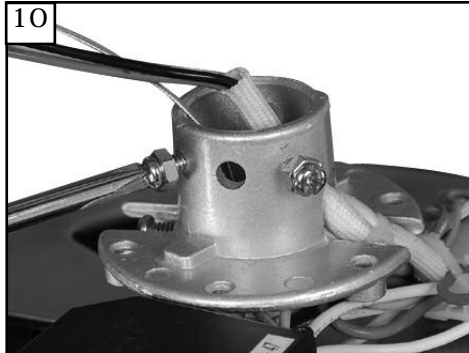

Loosen lock nuts and screws on yoke till you can not feel screw on inside of yoke.



Loosen set screw that holds ball.

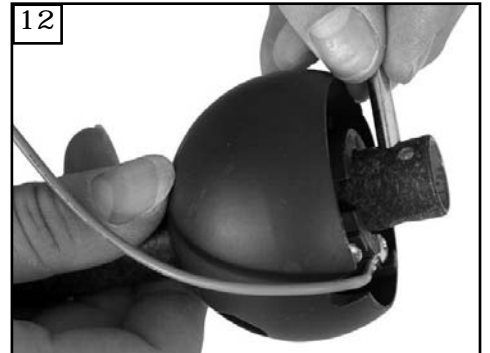

Slide ball down and remove pin save pin for later.

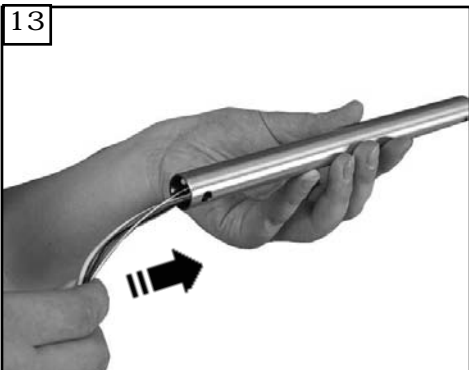

Thread leadwires and safety cable through downrod.

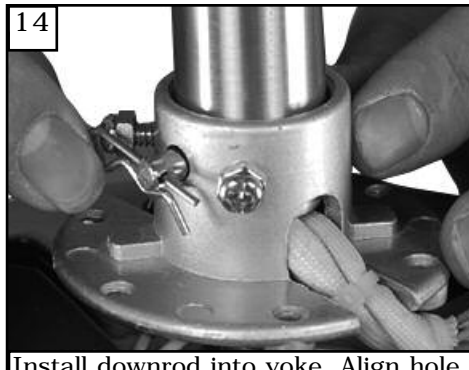

Install downrod into yoke. Align hole in downrod with hole in yoke and install cross pin. Install keeper into cross pin.

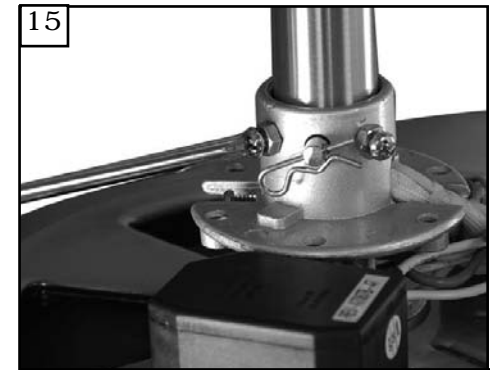

Tighten 2 downrod set screws and lock nuts.



Install yoke cover over downrod onto fan body.



Install arch arms to arch hub.



Tighten screw on arch hub into downrod to hold in place.



19 Install canopy onto downrod.

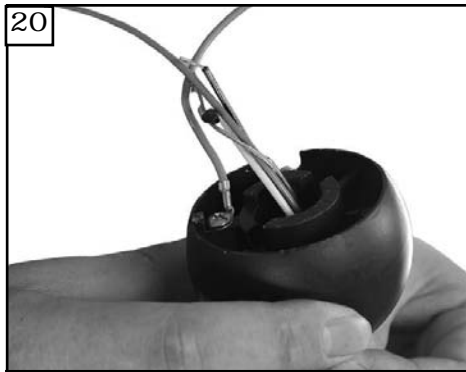

20 Thread leadwires and safety cable through ball.

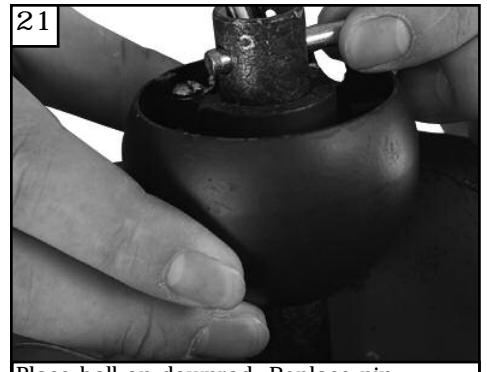

21 Place ball on downrod. Replace pin removed earlier and pull ball up so that the pin fits in the notches in the ball.



22 Tighten set screw to hold ball in place.

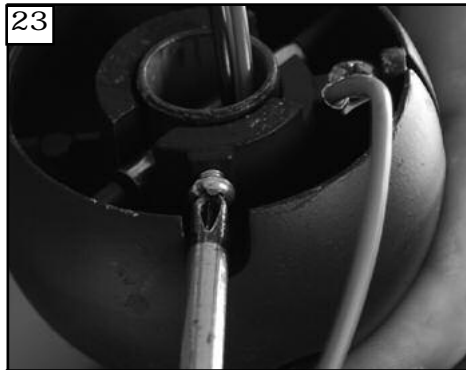

23 Tighten set screw to hold ball in place.

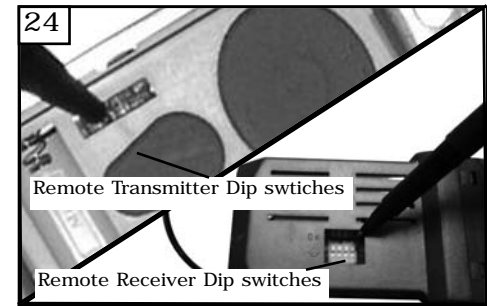

Remote Transmitter Dip switches

Remote Receiver Dip switches

24 Set dip switches on the Remote Transmitter and Remote Receiver to the same settings. This must be done so the units will communicate properly. If you have other fans you can set to control from one transmitter by setting both receivers the same as the transmitter. If you have more than one fan with remote. You can set the dip switches to different positions to have separate control.



25 Raise fan with downrod assembled to the ceiling bracket and hang fan assembly. Be sure to rotate the downrod ball so that the notch in the bracket engages the slot in the ball.

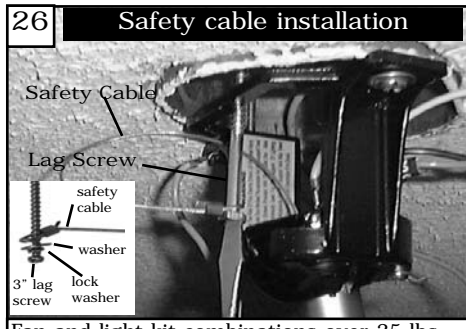

26 Safety cable installation



Fan and light kit combinations over 35 lbs, in both flush and downrod mode the safety cable must be installed into the house structure beams using the 3" lag screws, washers, and lock washers, provided. Make sure that when the safety cable is fully extended the lead wires are longer than the cable and no stress is placed on the lead wires.

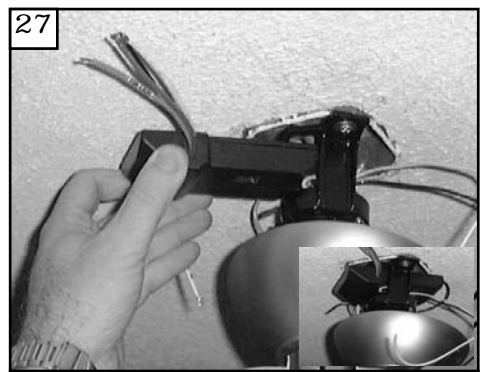

27 Install remote receiver by sliding into opening in the Mounting bracket. Make sure that the dip switches on the Transmitter and the Receiver are set to the same position. See Fig 44 for remote operation

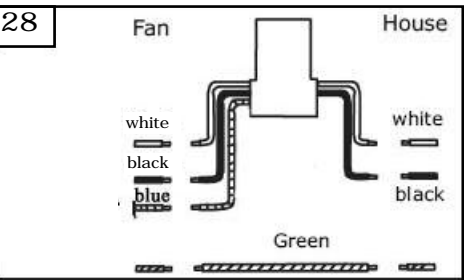

28 Make wiring connections as indicated above. White from fan to white from remote marked N. Blue from fan to blue from remote marked light. Black from fan to Black from remote marked L. White from house to white from remote marked AC N. Black from house to Black from remote marked AC L. Connect all green ground wires to Ground wire from House.



29 Make wire connections to power source using wire nuts provided. Make sure that no filaments are outside of the wirenut. After making the wire connections, the wires should be spread apart with the grounded conductor and the equipment-grounding conductor on one side of the outlet box and ungrounded conductor on the other side of the outlet box.



30 Lift canopy to ceiling aligning the key hole with the screws on the bottom of the mounting bracket. Rotate the canopy counter clockwise to lock in place. Tighten the screws to secure the canopy. See inset for keyhole shape



31 Align the blade and then the blade plate with castings on motor to attach blades to motor.

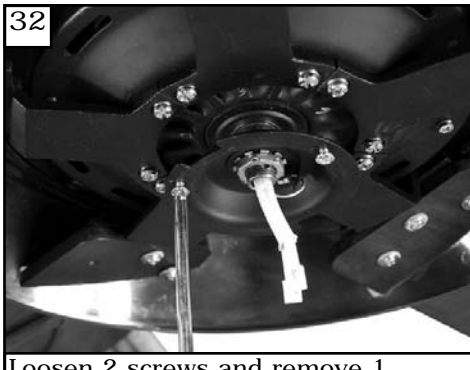

32 Loosen 2 screws and remove 1 screw. Save screw removed.



33 Twist lower cover plate into place by twisting in direction of arrow. Replace 1 screw removed and tighten all 3 screws securely.

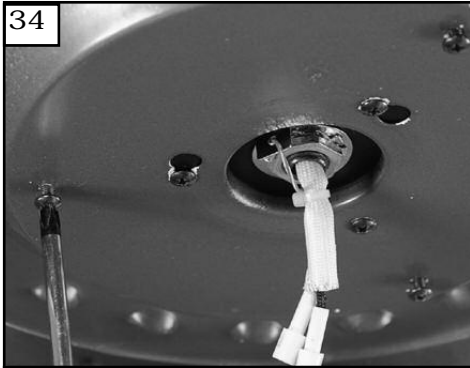

34 Loosen 3 screws on light plate as shown.



35 Plug white wire from fan to white wire from light kit. Then plug black wire from fan to black wire from light kit.

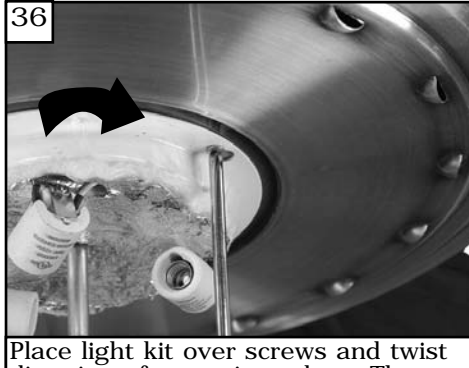

36 Place light kit over screws and twist direction of arrow into place. Then tighten all 3 screws securely.

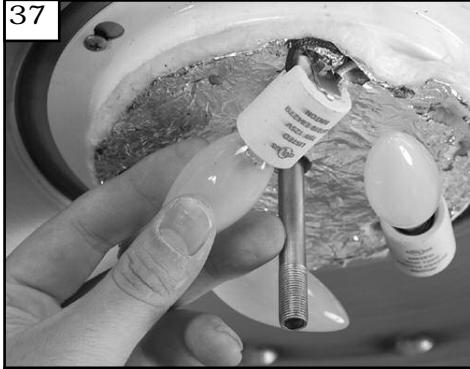

37 Install 3 x 60 watt candelabra bulbs. Bulbs not included.

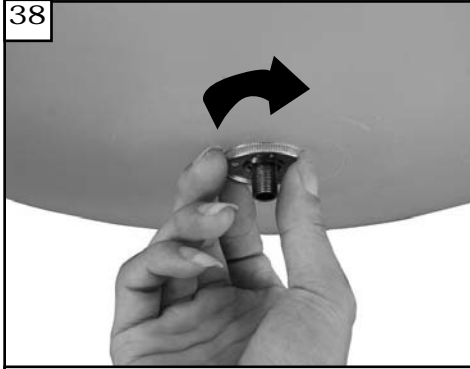

38 Install glass onto light kit, install rubber washer on the top side of the screw nut to hold in place and tighten in direction of arrow.

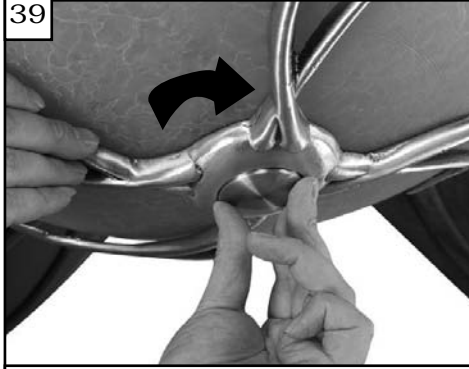

39 Install cage and finial cap and tighten in direction of arrow.

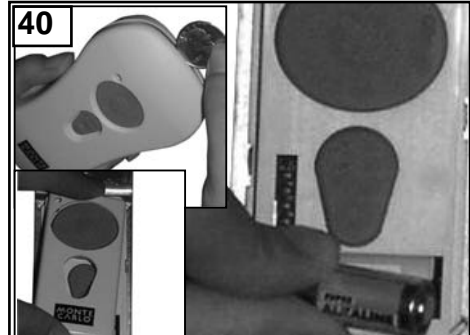

40 Remove cover by snapping off from top or bottom. Remove battery cover. Install 12V battery into wall remote. Duracell MN21 / Eveready A23 / GP 23A all 12V. Attach cover of remote by placing over buttons and snap the battery cover in place.



41 HAND HELD INSTALL Place face plate over battery compartment and buttons. Place remote over 2 pins on front cover. Attach cover of remote by placing over 4 pins and snapping into place.

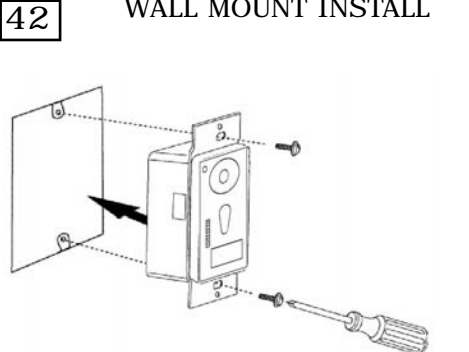

42 WALL MOUNT INSTALL Install wall control unit to outlet box using machine screws provided.

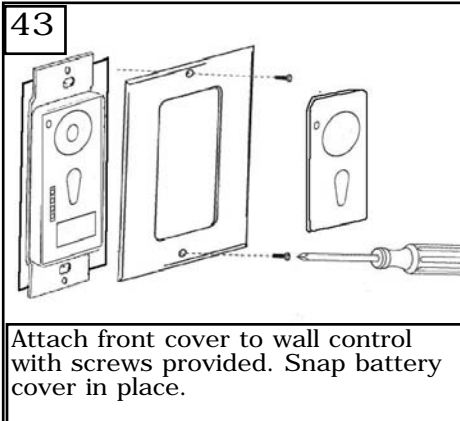

MONTE CARLO

Remote Control Transmitter Features:

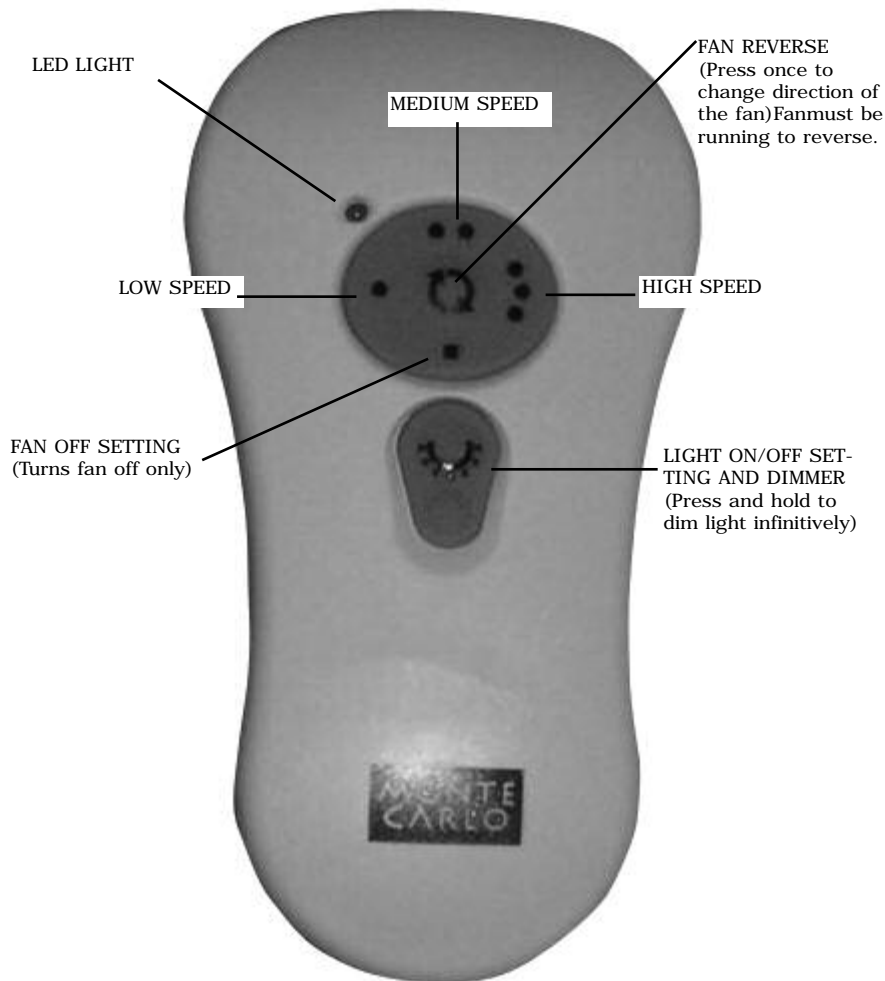

FAN SPEED Depress “1 dot” for low speed, “2 dots” for medium or “3 dots” for high. To turn fan off press square”.

LIGHT DIMMER To turn light on, press light dimmer once quickly. To turn off press once quickly while light is on. To dim light hold down button “light dimmer”. The light will cycle from bright to dim to bright until button is released. Light will maintain last setting if turned off.

FORWARD/REVERSE Depress rev button allow a few seconds for remote to change rotation direction with fan running.

Trouble Shooting

If you have difficulty operating your new ceiling fan, it may be the result of incorrect assembly, installation, or wiring. In some cases, these installation errors may be mistaken for defects. If you experience any faults, please check this Trouble Shooting Chart. If a problem cannot be remedied, or you are experiencing difficulty in installation, please call our Customer Service Center at the number printed on your parts list insert sheet. **Warning:** Before servicing or cleaning unit, Switch power off at Service panel and lock service disconnecting means to prevent power from being switched on accidentally. When the service disconnecting means cannot be locked, securely fasten a prominent warning device, such as a tag, to the service panel.

Trouble	Suggested Remedy
1. If fan does not start:	<ol style="list-style-type: none">1. Check main and branch circuit fuses or circuit breakers.2. Check line wire connections to fan and switch wire connections in switch housing.3. Check to make sure the dip switches from the transmitter and receiver are set on the same frequency. <p>CAUTION: Make sure main power is turned off</p>
2. If fan sounds noisy:	<ol style="list-style-type: none">1. Check to make sure all screws in motor housing are snug (not over tightened).2. Check to make sure the screws which attach the fan blade holder to the motor are tight.3. Check to make sure wire nut connectors in switch housing are not rattling against each other or against the interior wall of the switch housing. <p>CAUTION: Make sure main power is turned off before entering switch housing.</p> <ol style="list-style-type: none">4. Some fan motors are sensitive to signals from Solid State variable speed controls. DO NOT USE a Solid State variable speed control.5. Allow "break-in" period of 24 hours. Most noises associated with a new fan will disappear after this period.
3. If fan wobbles:	<ol style="list-style-type: none">1. Make sure that the ridge of the canopy engages the notch in the downrod ball.2. Check that all blades are screwed firmly into blade holders.3. Check that all blade holders are tightened securely to motor.4. Make sure that canopy and mounting bracket are tightened securely to ceiling junction box and junction box is mounted firmly to ceiling joist.5. Most fan wobble problems are caused when blade levels are unequal. Check this level by selecting a point on the ceiling above the tip of one of the blades. Measure this distance from blade tip to ceiling. Keeping measure within 1/8", rotate the fan until the next blade is positioned for measurement. Repeat for each blade. If all blade levels are not equal, you can adjust blade levels by the following procedure. To adjust a blade tip down, insert a washer (not supplied) between the blade and blade holder at the screw closest to the motor. To adjust a blade tip up, insert washer (not supplied) between the blade and blade holder at the two screws farthest from the motor. Reverse the position of the washer if blades mount from top of blade.6. If blade wobble is still noticeable, interchanging two adjacent (side by side) blades can redistribute the weight and possibly result in smoother operation.
4. If light does not work:	<ol style="list-style-type: none">1. Check wire from fan to make sure it is connected to hot wire from house.2. Check for loose or disconnected wires in fan switch housing.3. Check for loose or disconnected wires in light kit.4. Check for faulty light bulbs. <p>CAUTION: Make sure main power is turned off before entering switch housing.</p>

MONTE CARLO

Customer Service Center:
1-800-519-4092

6/21/06

REV.0

New made from 5GMR manual