



# ESPRESSO

PREFERENZA

Operating Manual



THE ULTIMATE MULTI-BEVERAGE SOLUTION FOR EVERYBODY.





Safety instructions ..... 4 - 7

Machines – Overview ..... 8

Start-up ..... 9

Prepare drinks ..... 10

Programming cup capacity..... 11

Insert water filter ..... 12

Clean the machine (daily / monthly).....13 - 15

Descale the machine every month.....16 - 17

Evaporate remaining water ..... 18

Frequently Asked Questions ..... 19

Specifications and servicing..... 20

Disposal instructions ..... 20

### Symbols and warnings



The warning triangle is used in the instructions where risks can result to the user or the machine when the safety instructions are not followed.



Warning: danger of scalding



Prohibited: do not reach into machine!



Prohibited: do not drink!



Recommended action

**If you fail to comply with the operating instructions and safety instructions, the machine may become dangerous to operate. Please retain the operating instructions and pass them on with the machine should this be passed on.**

Do not start the machine if it is damaged or if it does not work properly. In that case, immediately pull the plug out of the mains socket and contact the Service Hotline.

The machine is designed and manufactured for domestic use. The manufacturer assumes no liability for consequences arising from commercial use, use not in compliance with its intended purpose or noncompliance with the operating manual. This machine is intended to make hot drinks as stipulated in the operating instructions.

This machine is intended for use in households and similar areas, such as staff rooms in offices and shops, as well as other work-related facilities; also in farms, for use by guests in hotels, motels and bed & breakfast establishments. The machine may only be used for its intended purpose.

In case of long periods of absence, vacation etc., the machine must be emptied, cleaned and the mains plug must be removed from the socket.

When there is risk of frost, all residual water must be removed, see the section on „Evaporate remaining water“ on page 38.

The mains voltage must match the specifications on the nameplate. Only connect the machine to a grounded 3-pin wall socket. In the case of an incorrect connection your warranty rights may be forfeited.

Do not damage the mains cord by placing it on or near hot objects or over sharp edges. Do not allow the mains cord to hang down (risk of tripping). Do not touch the mains cord with wet hands. Do not pull the plug from the socket by pulling on the cable. If the mains cord shows signs of damage, do not start the machine.

When the mains cable of the machine

is damaged it must be replaced by the manufacturer, the respective customer service or a similarly qualified person in order to avoid any hazards.

Do not place the machine on a hot surface (e.g. cooker) or operate it next to heat sources or fires. Do not place the machine on its mains cable. Always place the machine on a stable, flat and water-repellent surface.

For health reasons, only fill the water tank with fresh drinking water.

#### **How to avoid injuries and scalds when using the machine.**

Do not leave the machine unattended during beverage preparation.

This machine can be used by children from the age of 8 years and older and by persons with reduced physical, sensory or mental abilities or who lack experience and knowledge provided they are supervised or have been instructed regarding the safe operation of the machine, and understand the resulting dangers.

Cleaning or servicing of the machine that is normally carried out by the user must not be carried out by children unless they are 8 years old or older and act under supervision.

The machine and its connection cable must be kept out of the reach of children younger than 8 years. Children must not play with the machine.

Never open the lever on the machine during the brewing, rinsing, cleaning or descaling processes. When a process has been completed and the lever is then opened, never hold your fingers under the spout - there is a risk of scalding from remaining hot liquid dripping from the spout! When the brewing process has been completed, slowly open the lever in order to eject the capsule; do not bend over the capsule insertion opening (risk of hot liquid sprays).

Never reach with your fingers into the capsule insertion opening - risk of injury!

Do not use the machine without drip tray and drip grating! Do not overfill the water tank. Never lift the machine by its lever.

Store the machine and all its accessories outside the reach of children.

Never open the machine or insert objects into the machine openings.

In order to avoid any hazards, any work beyond the normal use of the machine, its cleaning, descaling and maintenance, such as repairs or replacing the mains cable may only be carried out by a customer service authorised by the manufacturer.

Before cleaning the exterior of the machine, unplug the mains cord and allow the machine to cool down. Do not clean the machine or the mains cord or the mains plug with water and do not immerse the machine in water.

Do not clean the machine under running water. Never put the machine or its parts into a dishwasher.

Refer to the instructions for use of all cleaning and descaling agents before use and comply with the safety regulations.

Never use a damaged or deformed capsule. Only use drink capsules marked with the K-fee® system logo that are intended for the machine.



**Only use original K-fee® system capsules! Look for the red K-fee® system logo and the characteristic fluted shape of the capsules.**

Using non-original capsules involves the following risks:

**1. Health hazards**

When using non-original capsules, differences in the brewing process and

the capsule design can cause hot water to escape under high pressure - risk of scalding!

**2. Damage to the machine and warranty**

When using non-original capsules, differences in the brewing process and the capsule design will cause damage to the machine which means that any warranty claims may be forfeited!

**The manufacturer and his distribution partner cannot be held liable for any injury or damage which is the direct or indirect result of non-original capsules being used**  **with this machine.**

These operating instructions are also available as download from our website: [www.k-fee-system.com](http://www.k-fee-system.com)

EN Machines –  
Overview

- 1 Drip grating
- 2 Spent capsule container
- 3 Controls
- 4 Capsule insertion opening
- 5 Lever
- 6 Water tank
- 7 Water filter (optional)
- 8 Spout
- 9 Height-adjustable drip tray



**WARNING**

The machine produces very hot water (for brewing, descaling, cleaning and rinsing). In order to prevent scalding and other injuries always ensure that the lever is fully closed when the machine is running. Do not reach under the spout and do not remove the drip tray.

**Light signals**

Button lights up:  
READY, button can be pressed.

Button flashing: please wait. Machine is either heating up, dispensing a drink or rinsing.

	On/Off button
	Small cup
	Large cup
	Rinsing button



**Caution!** Four pointed needles open the capsule in the machine. Do not reach into the capsule insertion opening in order to avoid injuries.

With the exception of the water filter, all illustrated parts and these original operating instructions form part of the delivered package. Before starting up the machine, please check that you have received all parts.



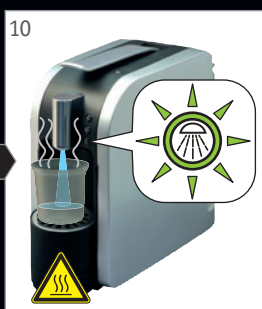
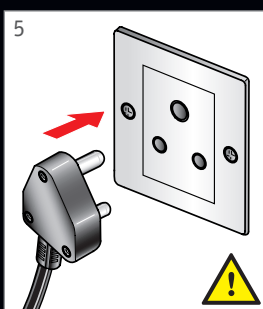
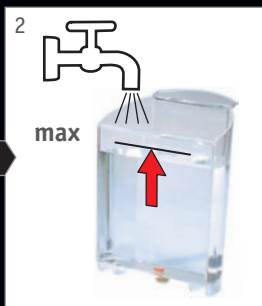

## Start-up

EN



Before starting up the machine, the safety instructions on pages 24 to 27 must be read.



When the machine was exposed to temperatures below freezing point, please wait at least 3 hours before starting up the machine so that it can warm up again to reach room temperature. When the machine is very cold or frozen it is possible that it does not function correctly.





Very hot water – risk of scalding!



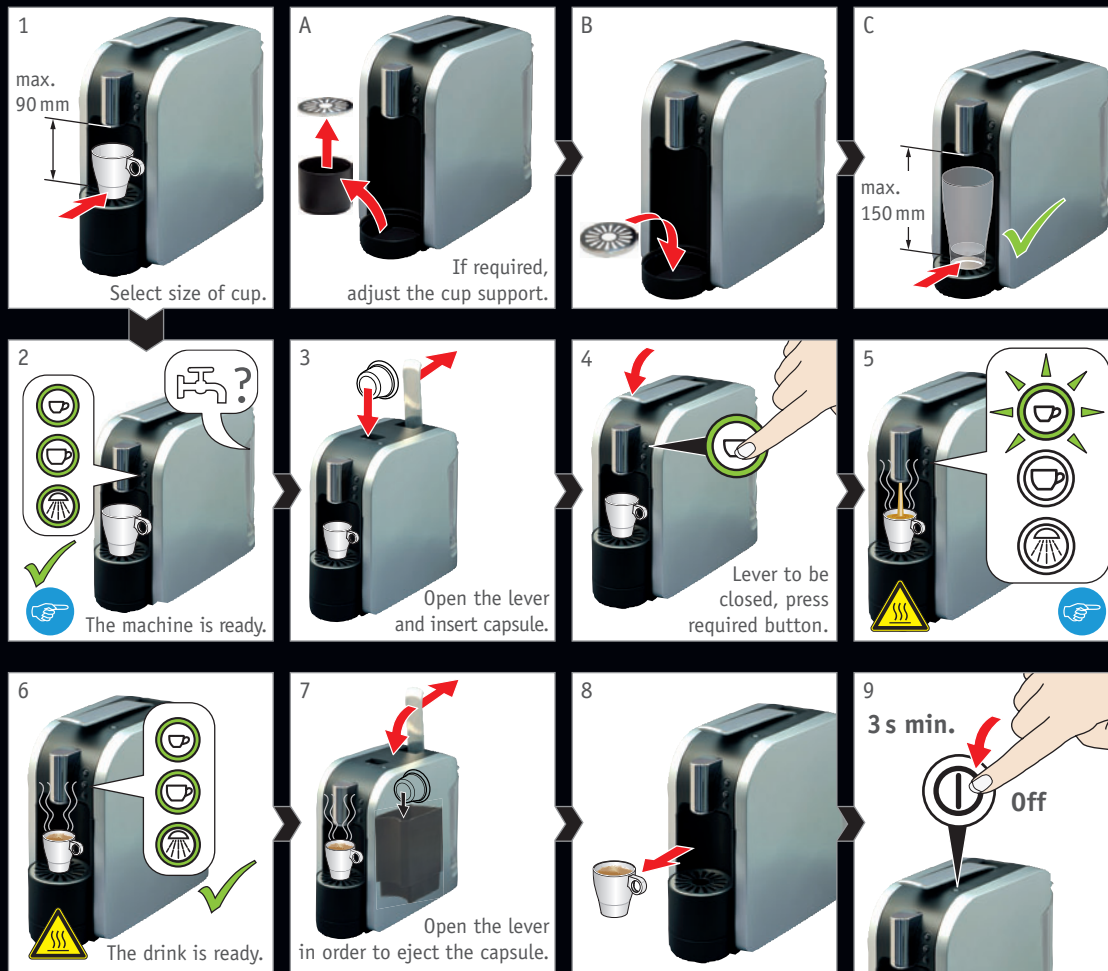

Before using the machine for the first time, run 4 rinsing cycles. To do that, press the rinsing button once the previous rinsing process has been completed. When using a water filter, please read the instructions on page 32.

**EN** Prepare drinks  
(e.g. espresso)



 The machine automatically switches off if it is not used for 5 minutes. If necessary, use the on/off button to reactivate the machine before preparing new drinks.

 Very hot water – risk of scalding!

 The brewing process can be stopped by pressing any button a second time.

## Programming cup capacity EN



First insert a capsule before programming the cup fill quantity.



Very hot drink – risk of scalding!



Presettings:  
small cup.....approx. 50 ml  
large cup .... approx. 100 ml

### Adapting the fill quantity to your cup size:

Keep the „small cup“ or „large cup“ button depressed for at least 3 s in order to start the programming. Proceed to keep the button depressed until the required fill quantity has been reached.

The new fill quantity remains stored (also after an electricity outage).

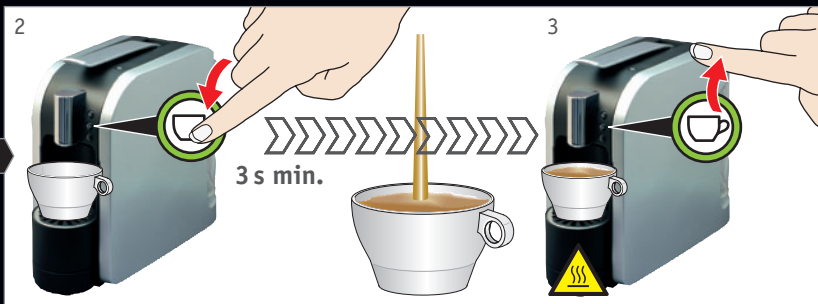
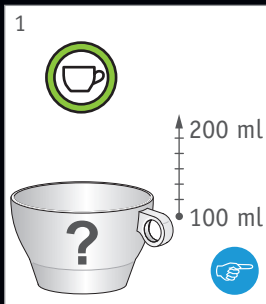
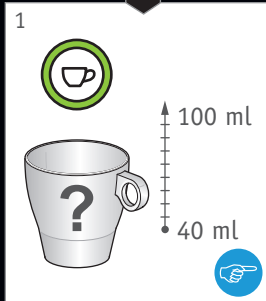

**EN** Insert water filter



**Safety instruction!** Please carefully read the water filter operating and safety instructions. For reasons of hygiene we recommend replacing the water filter at least every 3 months.



Very hot water – risk of scalding!



Use the rotary scale to set the month for the next filter change. The hardness of the water determines the service life of the water filter (see water hardness table on page 37). For an average consumption of one full water tank per day we recommend a filter change:

every 3 months	soft water
every 2 months	medium-hard water
every 1 to 2 months	hard water
monthly	very hard water

**1** Wasserfilter zum Schutz vor Verkalzung, zur Entfernung von Geruchs- und Geschmacksstoffen (Chlor, etc.) und zur Optimierung der Getränkequalität. Ausschließlich Wasserfilter benutzen, die für das K-fee® System geeignet sind. Nähere Informationen erhalten Sie auf unserer Webseite unter: [www.k-fee-system.com](http://www.k-fee-system.com)

**2** Eject existing capsule.

**3** Rinse the machine.

**4** (Warning icon: steam waves)

**5** Empty the water tank.

**6** (Instruction icon: hand pointing)

**7** Insert water filter and push down firmly.

**8** max

**9**

**10** Rinse water filter 2 x in sequence.

**11** (Warning icon: steam waves)

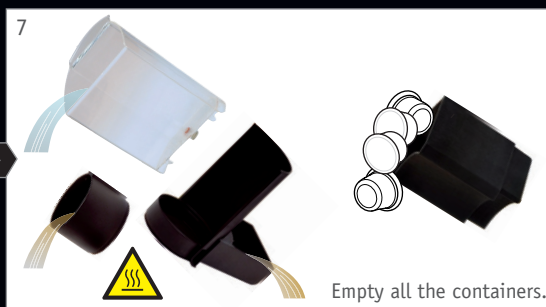
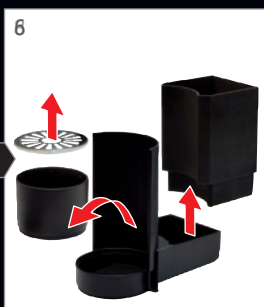
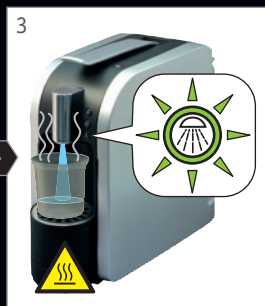

**Danger to health:**  
When the machine is not used for longer periods without prior rinsing or cleaning, it is possible that deposits form which are difficult to remove.

**Risk of damage!**  
Only use a damp cloth and a mild cleansing agent (no scouring agents or aggressive cleaning products).  
No not wash machine parts in the dishwasher.

Clean the machine **EN**  
every day (or after its last use)





Very hot water – risk of scalding!





**Risk of scalding!**  
Carefully empty the drop tray and spent capsule container.

**EN** Clean the machine every month

 **Danger to health:** Carefully read the operating instructions for the cleansing agent and follow the safety instructions.

 **Caution!** Remove the water filter before cleaning.

 **Risk of scalding!** Carefully empty the drip tray and spent capsule container.

 Repeat the rinsing process (images 7, 8, 9) a total of 8 x.

 Very hot water – risk of scalding!

 **Danger to health:** Do not drink any cleansing liquid.

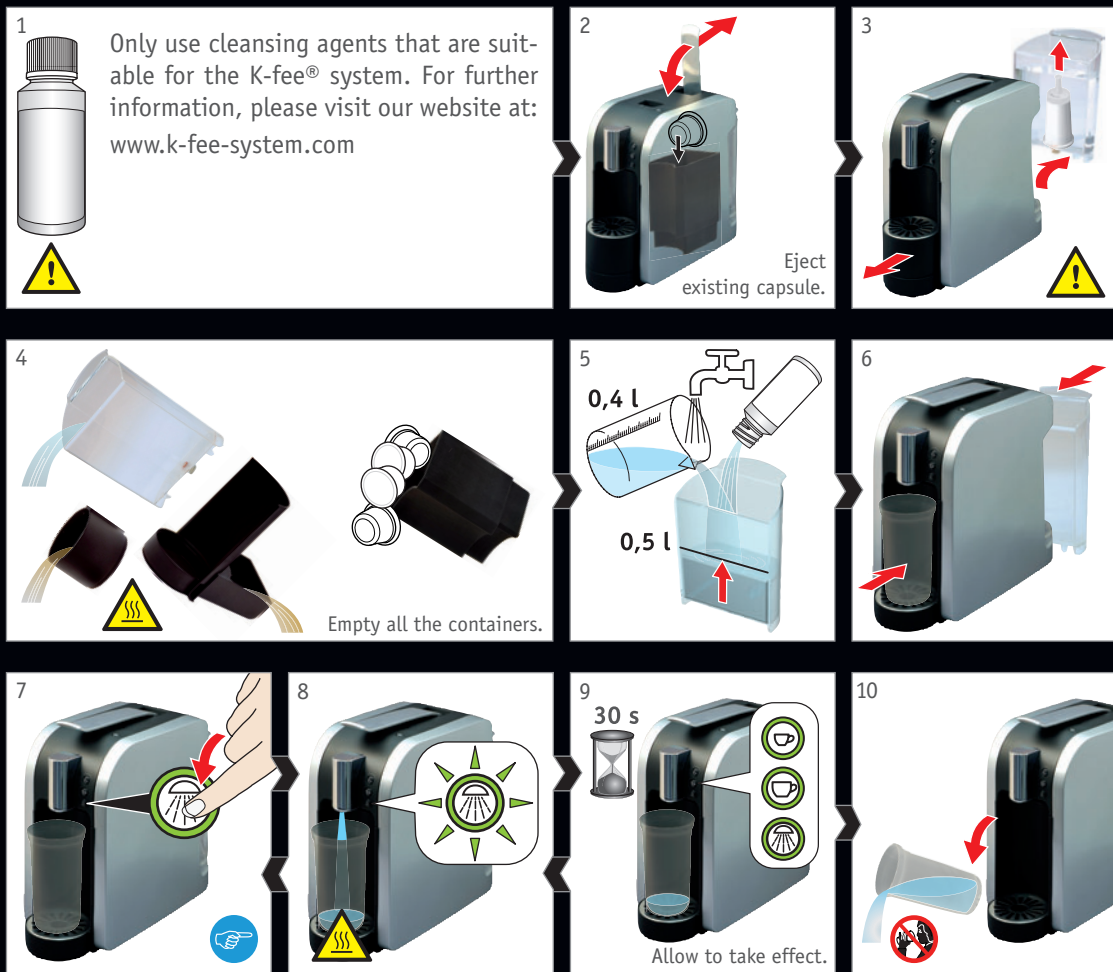

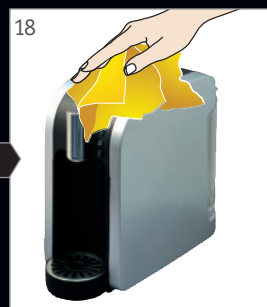
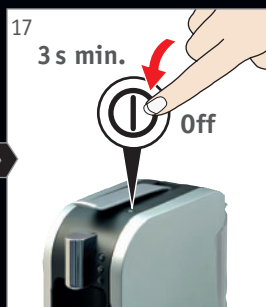
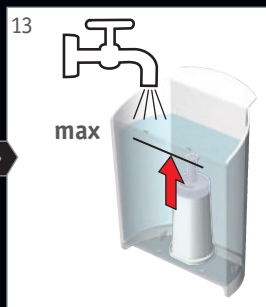
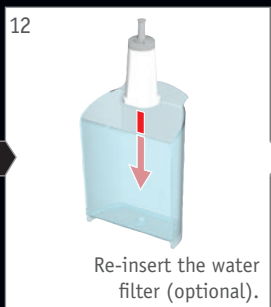
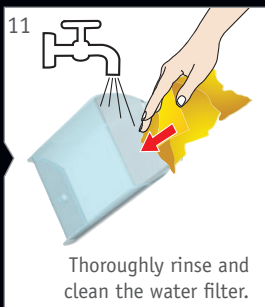



Clean the machine every month (continued) **EN**

  
Very hot water – risk of scalding!





**EN** Descale the machine every month.

 **Danger to health:** Carefully read the operating instructions for the descaling agent and follow the safety instructions.

 **Caution!** Remove the water filter before descaling.

 **Risk of scalding!** Carefully empty the drip tray and spent capsule container.

 Repeat the rinsing process (images 7, 8, 9) a total of 8 x.

 Very hot water – risk of scalding!

 **Danger to health:** Do not drink any cleansing liquid.

1 Only use descaling agents that are suitable for the K-fee® system. For further information, please visit our website at: [www.k-fee-system.com](http://www.k-fee-system.com)

2 Eject existing capsule.

3

4 Empty all the containers.

5 0,4 l 0,5 l

6

7

8

9 30 s

10 Allow to take effect.



Descal the machine every month (continued)

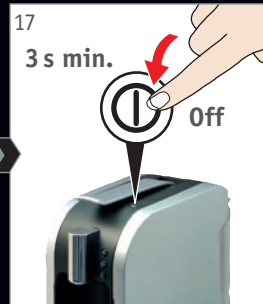
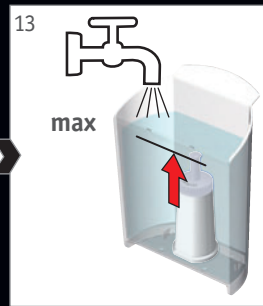
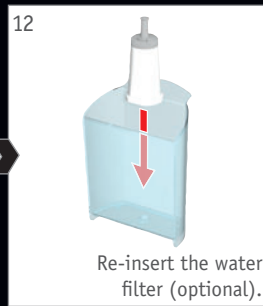
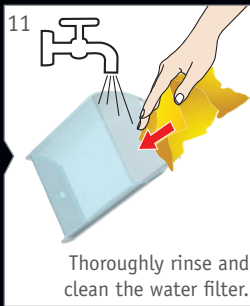

Very hot water – risk of scalding!

When no water filter is used the machine must be descaled every month in order to retain optimum function.



For further information regarding water hardness in your area, contact your water company.

#### Water hardness table

Degree of hardness	Water hardness in mmol
1 (soft)	< 1.3
2 (medium-hard)	1.3 - 2.5
3 (hard)	2.5 - 3.8
4 (very hard)	> 3.8

## Evaporate remaining water

With this function, any remaining water in the machine is evaporated and removed. This prevents any residual water freezing in the machine when the machine is transported or stored at temperatures below freezing point.



### CAUTION

Extreme temperatures can cause damage to the machine (permitted operating temperature 10 - 45°C). For this reason the machine

- must be protected against frost,
- must not be used at temperatures below 10°C,
- must not be used at temperatures over 45°C.

### Procedure

- If necessary, warm up the machine until it reaches room temperature.
- Open and close the lever in order to eject any existing capsule.
- Take out and empty the water tank.
- Ensure that the machine is switched off.



### WARNING

Risk of scalding! The evaporation process results in hot steam (up to 120°C) and hot water.

Do not reach under the spout and maintain a safe distance from the spout.

- Hold the „small cup“ and the rinsing button depressed at the same time. Now press the on/off button. Evaporation starts and the „large cup“ button flashes green.
- After the evaporation process the machine switches off automatically.
- Re-insert the empty water tank.
- Empty and dry the drip tray and spent capsule container.
- Use a dry cloth to wipe the front of the housing.

## Frequently Asked Questions EN



The machine will only work with capsules marked with the K-fee® system logo.

### **Is the drink dispensing process delayed?**

The machine will re-adjust the temperature for the requested drink.

### **Is the spent capsule container overfull and jammed?**

Try to remove the spent capsule container by joggng the container gently to and fro.

### **Is the drink not hot enough?**

Pre-warm the cup. If necessary, descale the machine – see the "Descale the machine every month" section.

### **Are all buttons flashing at a fast rate?**

Switch the machine off and remove the plug from the mains supply. If the problem persists, please inform Customer Service.

### **Is the drink not dispensed properly?**

Push the lever fully down. If necessary, descale the machine – see the "Descale the machine every month" section.

### **Do I have to descale the machine if I am using the water filter?**

If the water filter is regularly changed, no descaling is necessary. Nevertheless, it is possible that mineral deposits occur depending on the water quality and the machine location. For this reason we recommend an annual cleansing/rinsing process using a K-fee® system descaler.





### **Does the machine suddenly switch off during a period of intensive use?**

If the cooling-down period is too short, the machine switches itself off as protection against overheating. In this case allow the machine to cool down for about 30 minutes before using it again.

### **Does the machine switch itself off?**

The machine switches off automatically if it is unused for more than 5 minutes. Please remember that the machine uses power as long as it is plugged into the mains socket (< 0.5 W).

**EN** Specifications and servicing

	220-240 V~, 50 Hz, max. 1455 W
	1 m
<b>P</b>	max. 19 bar
	1 l
	3.8 kg

	A = 150 mm B = 378 mm C = 297 mm
	max. 150 mm
	10°C - 45°C
	~ 90°C



**If you have any queries or suggestions, please contact us:**  
 Foghound Interactive  
 Service Centres in Johannesburg and Cape Town.

**Foghound Interactive**  
 24 Richards Drive  
 Midrand  
 Tel: 087 943 7177  
 Email: support@espresto.co.za

**EN** Disposal instructions

The packaging is recyclable. Ask the responsible authorities in your local council offices for further information about recycling.

**Environmental protection has priority!**

-  The machine is made of valuable materials that are recyclable.
-  The machine bears the sign for waste electrical and electronic appliances in accordance with European Directive 2002/96/EC (WEEE).

This directive regulates the return and recycling of waste appliances within the EU. For this reason, only dispose of the machine at a public recycling yard in your vicinity. The machine must not be disposed of as part of normal domestic waste.



# ESPRESSO

PREFERENZA

K-fee System GmbH, 51469 Bergisch Gladbach, Germany  
[www.my-espresso.com](http://www.my-espresso.com)

