

TOUCHBGA



BGA Rework Station

IR6000

User Manual

Table of contents

1. IR6000 BGA rework station features

1.1. Safety Instructions

1.1.1. Electric Safety

1.1.1. Operation Safety

1.1.3. Environmental requirements of operation and conservation

2. The operation and conservation condition of products

2.1. The parameters of IR6000 BGA Rework Station

2.2. Hardware description and Self-help install

2.3. Temperature-controlled meter Operation instructions

2.4. BGA Rework operation steps

2.5. Prompt

1. IR6000 BGA rework stations features

IR6000 BGA Rework Station is designed to meet the ever-changing demands of today's fast BGA Rework manufacturing environments.

This model have following characteristics:

1. Rework station for laptop motherboards, desktop computer motherboards, server boards, industrial computer boards, all kinds of game boards, communications equipment motherboards, LCD TVs and other large circuit board BGA rework.
2. Innovative designs. An effective solution to general of infrared rework station vulnerable to the impact of air flow. Will lead an inaccurate of temperature control. Maximum temperature up to 400C. Can easily deal with lead-free soldering rework.
3. Can set up 8 rising temperature segments and 8 constant temperature segments to control. It can save 10 groups of temperature curves at one time.
4. Can be connected to a computer to be controlled more conveniently with a built-in PC RS232 serial port and proprietary Software attached to it. Programmable.
5. Can easily rework the variety of CPU's seat, all kinds of shielding enclosures, replacement of various components slot. Can easily deal with lead-free soldering rework.
6. Sensitive temperature measurement sensor to obtain an accurate and instantaneous temperature reading and monitoring.
7. BGA rework station the technology of closed-loop temperature control ensures accurate temperature process and even heat distribution.
8. Machine overall system integration design. Rework station more integrated workbench area occupied by smaller. Didn't mixed and disorderly of cables.
9. Linear guide type Bracket for BGA Reworks can be locking adjusted by rotating the handle. Can be very easily fixed PCB board, effectively prevent the deformation of PCB board.
10. Detachable K type thermocouple.
11. Taiwan FOTEK SSR's inside. Popular programmers inside.

1.1.Safety Instrouctions

1.1.1.Electric Safety

1. Make sure the supply power voltage accord with the standards 220V-250V/50hz alternating current before installing.
2. To avoid possible electric shock caused serious damage, please disconnect the power cord from the outlet temporary before moving machines.
3. If the machine damages, please contact us for maintenance. If the damage caused by the users when they dismantle or repair independently, they should take on the loss by themselves.

1.1.2.Operation Safety

1. Please carefully read the relevant information provided by the manual before starting using this product.
2. Make sure the power cord has been properly connected properly before using the products.
3. Installed the equipment in stable work platform to use, where the air mobility should be small as possible. Avoid it closing to air conditioners, fans and the other outlet.
4. In case of electrical short-circuit, avoid the products contacting with water.
5. Forbid using this equipment in flammable and explosive substances.
6. The operators' hands or other parts of the body should maintain a safe distance from the heater. Forbid touching the heater to avoid scalding.
7. If you have any technical questions or suggestions in the course of using this product,please contact with our technology department. We will try our best to solve.

1.1.3.Environmental requirements of operation and conservation

1. Operation environment of products
 - Operation temperature: 15 – 45C
 - Operation humidity: 5% to 95%, non-condensing
 - Products should be kept in the air mobility of a smaller environment under the welding operation.
2. Conservation environment of products
 - Storage temperature: -20 – 70C
 - Storage humidity: 5% to 95%, non-condensing

2.1.The parameters of IR6000 BGA Rework Station

Heating kind	IR/HR
Dimension	450x340x430mm
Weight	12kg
Electrical Parameters	
Power	220V AC (3250W total)
Upper Heating	IR/HR
Size of Upper heating	IR-80x80mm
Consumption of upper heating	IR-450W / HR-1000W
Size of Bottom heating	205x210mm
Consumption of Bottom heating	3x600W
General power	IR+IR-2250W / IR+HR-2800W
Temperature Control	
Control mode of Upper	Independent temperature control, high-precision closed-loop control, precision $\pm 0.5\%$, Alarm
Control mode of Bottom	Independent temperature control, high-precision closed-loop control, precision $\pm 0.5\%$, NO Alarm
Rework Function	
BGA	Suit for welding, remove or repair packaged devices such as BGA,PBGA,CSP,multi-layer substrates,EMI metallic shield product and solder/lead free Rework welding
Size of applicable chips	$\leq 80 \times 80 \text{mm}$
Size of applicable PCB	$\leq 400 \times 305 \text{mm}$

2.2. Hardware description

IR6000 BGA Rework Station is composed of upper part of Heating Components / Bottom Preheat Module / Bracket / Temperature Control Parts!

Temperature control Table is control the upper and lower heating, Can Simultaneously heated or first preheat, then the upper part of heating.

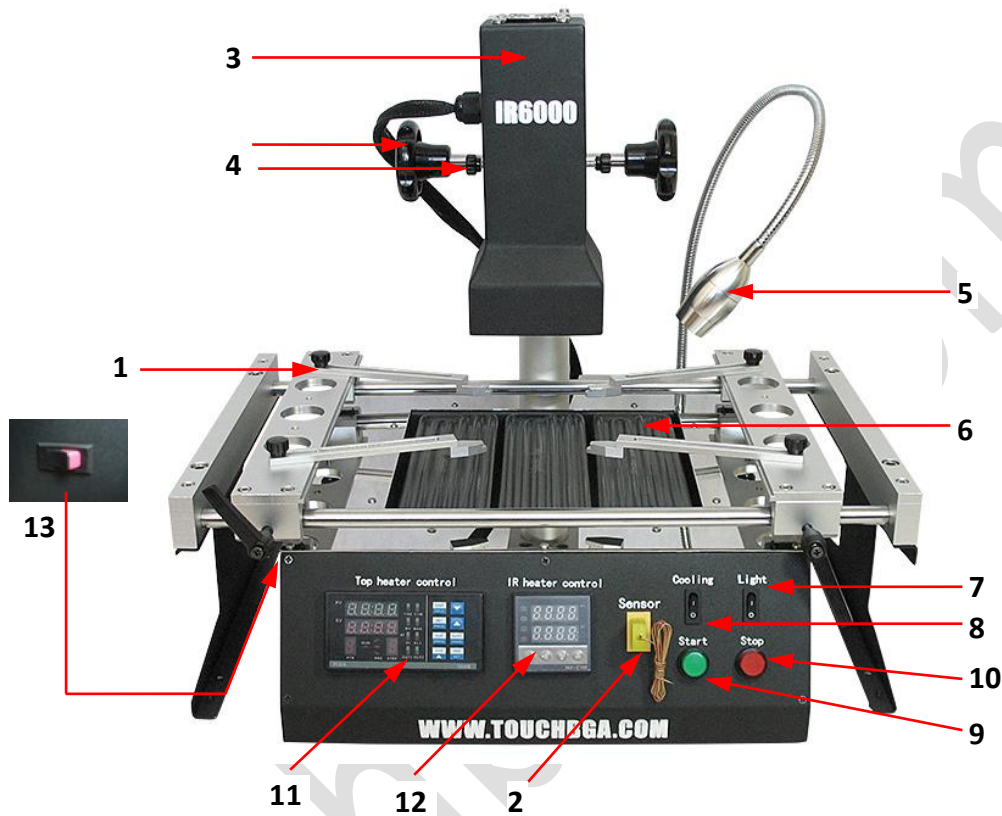

1. PCB Table
2. Highly Sensitive K-temperature sensor
3. Upper Heater
4. X-Y Lifting Regulators
5. LED Auxiliary Lighting
6. Bottom Heater (Pre-Heater)
7. Lighting Switch
8. Upper fan Switch
9. Start Switch
10. Stop Switch
11. Upper Programmable Temperature Controller
12. Bottom Temperature Controller
13. Power Switch

Self-Installation Instruction

PCB Table

1. Installation side support.

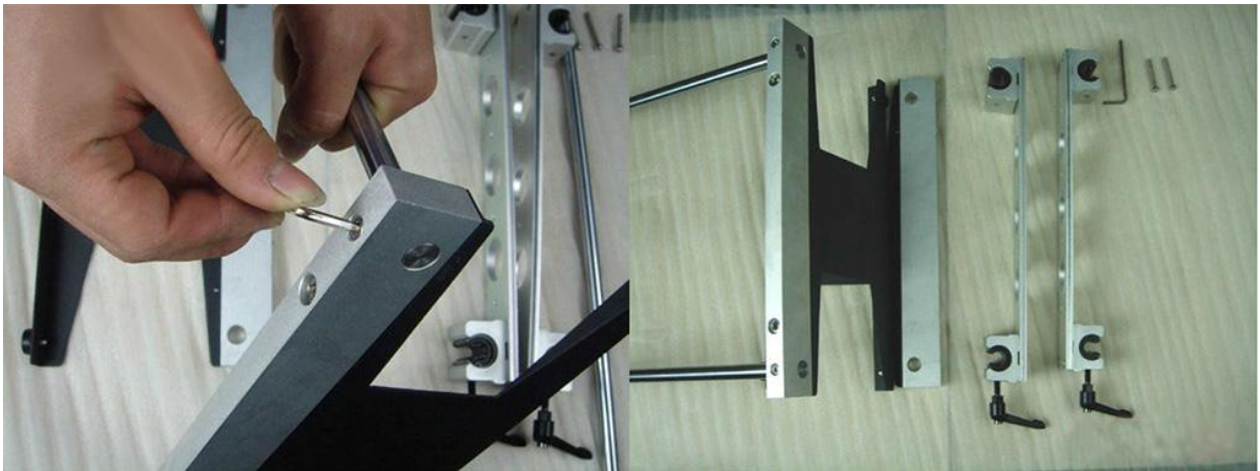

2. Installation Slip.



3. Installation side support.

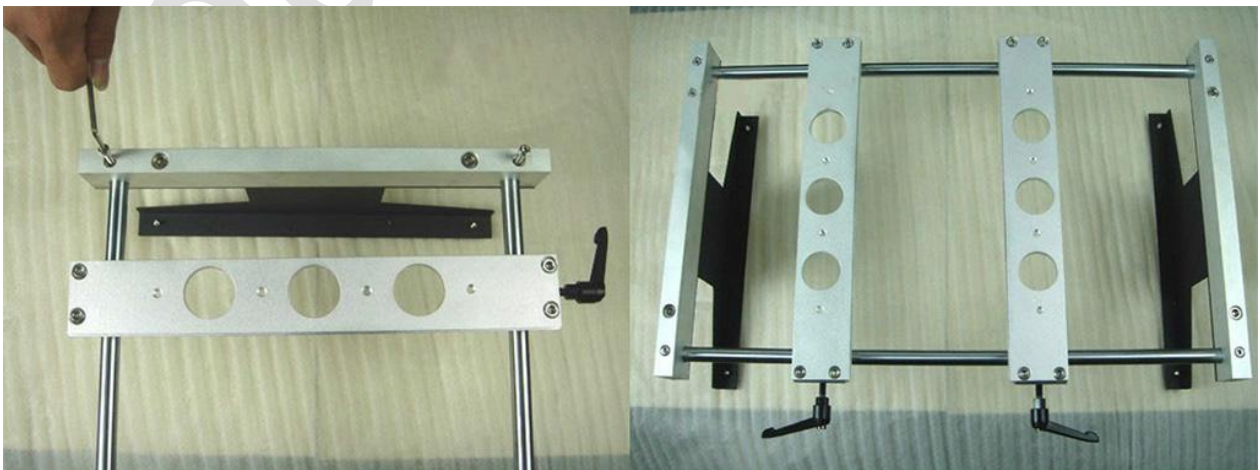

Upper Heater



Top head cable connector, RS232, power connector



Temperature sensor



Installation of RS232 communication interface for Desktop & Laptop



2.3. Temperature-controlled meter Operation instructions

TOP Programmer/Controller General Description

The programmable controller contains an in-built setpoint generator in addition to the controller function. This setpoint generator can produce a temperature/time profile with 10*16 segments (0~9*10 Sets of Curves). When the program is running, the current setpoint from the setpoint generator is fed to the control algorithm. The current setpoint is continuously shown on the lower display.

The sixteen segments are defined in the order: Ramp 1, Dwell period 1, Ramp 2, Dwell period 2..., and are executed in succession.

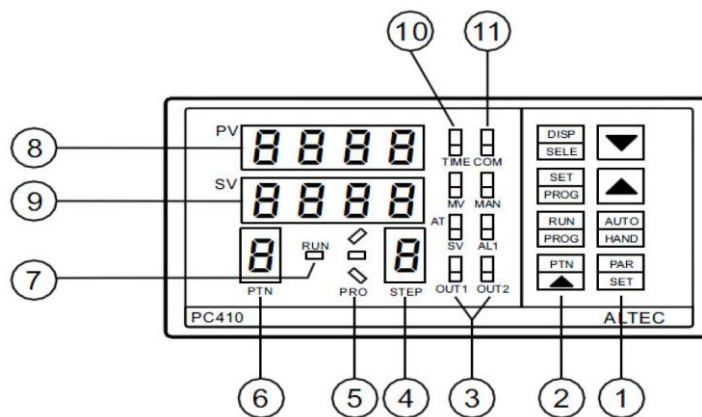

S.N.	Item	Functions
①		Parameters setting key
		(Up key) Increase value
		(Down key) Decrease value
②		Selects the program pattern number
		Starts/hold the program, changes the mode from fixed value control to program control
		Program parameters setup
		Changes the indication on SV/MV/TIME display
③	OUT1	Output indicator
④	STEP	Indicates the step number of program
⑤	PRO	(Program monitor indicator) During program control, '/' is lit when the PV is rising During program control, '-' is lit when the PV is constant During program control, '\' is lit when the PV is falling
⑥	PTN	(Pattern number display) Indicates the pattern number '0~9'
⑦	RUN	(Program control running indicator)

		The LED indicator is lit during program control
⑧	PV	(PV Display) Indicates the Process/Measured value
⑨	SV	It is lit when the Setting Value(SV) is being displayed on the lower display
⑩	TIME MV SV	(SV/MV/TIME display) It indicates the Setting Value(SV), Manipulating Value(MV), or Time(TIME) (The display content can be changed by the 'DISP/SELECT' key)
⑪	AL1	It is lit when the Alarm1 output is 'ON'
	COM	(Communication indicator) It flashes when the controller is in active communication with a host computer

Program Parameters Setting

Ramp Rate1: $r1$

A ramp consists of a slope(linear gradient) and a target setpoint. The control setpoint increases or decreases at a linear ramp rate from the actual measured value until a specified target setpoint is reached. The relative positions of the actual measured value and the target setpoint determine whether the slope of the ramp is positive or negative. Parameters R1, R2, R3... express the ramping rate in unites per minute(0.01~99.99), parameters L1, L2, L3... the appropriate target setpoint in display units.

If $R1 = \text{END}$, the program will be ended when the program runs to the slope.

Target Setpoint 1: $L1$

The target value to which the setpoint ramps when the programmer has been placed into RVN.

Dwell period 1:

In a Dwell period, the target setpoint, which has been attained, remains unchanged for a fixed period. All the dwell periods are defined by their duration in minutes with parameters D1, D2, D3...(0~9999). When the program is running, these parameter display the time remaining in the active dwell period. If the parameter equals zero, the dwell period is skipped.

When the controller runs in the **PV** displaying status:

- 1). Select the target program pattern number with the **PTN/** key.
 - 2). press **SET/PROG** key, the first program parameter appears in the upper display. The value associated with this parameter will be shown in the lower display.
 - 3). Use **▲** and **▼** key to modify the value.
 - 4). Press the **PAR/SET** key, the next parameter appears. At the same time, the modification has been saved in the memory. Use **▲** and **▼** key to modify the value.
- Repeat this procedure till all the parameters are set. Or if there is no key operation within 16 seconds, the menu times out automatically.

Program Parameter List

S.N.	Mnemonic	Parameter	Adjustable Range
1	Lc	Program Loop Counter	1~200, <i>cont</i> (continuous)
2	$r1$	Ramp Rate 1	<i>End</i> ; <i>StEP</i> ; 0.01~99.99 units/(min, sec)
3	$L1$	Target Setpoint 1	$SP_L \sim SP_H$
4	$d1$	Dwell Time 1	0 ~ 9999 min
5	$r2$	Ramp Rate 2	<i>End</i> ; <i>StEP</i> ; 0.01~99.99 units/(min, sec)
6	$L2$	Target Setpoint 2	$SP_L \sim SP_H$
7	$d2$	Dwell Time 2	0 ~ 9999 min
...
8	$PL1$	ramp 1 and dwell 1 output power limit	0.0~100%
9	$PL2$	ramp 2 and dwell 2 output power limit	0.0~100%
...

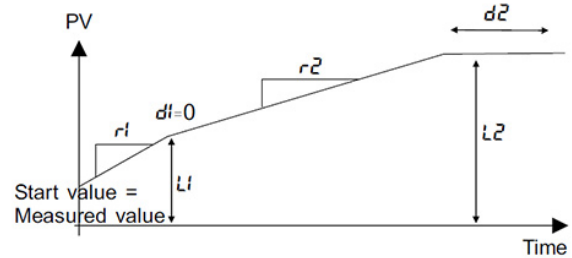
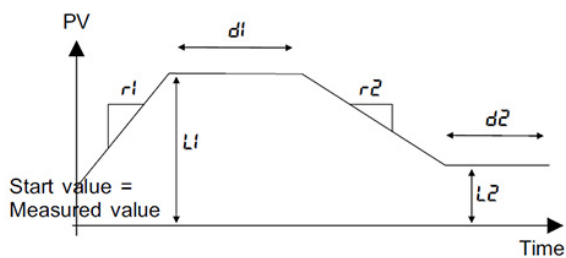
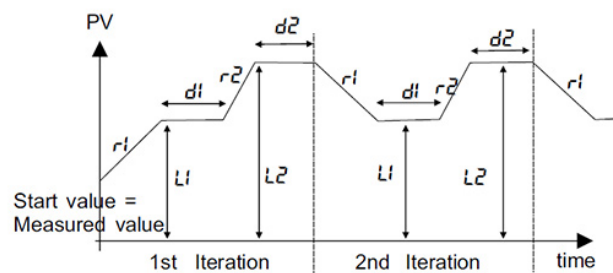
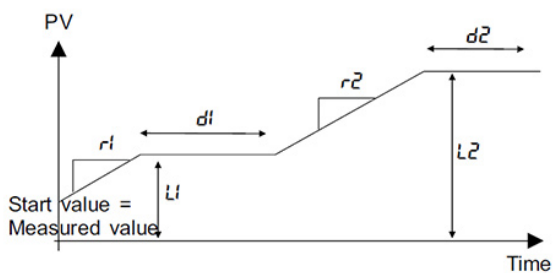

BOTTOM Programmer/Controller General Description

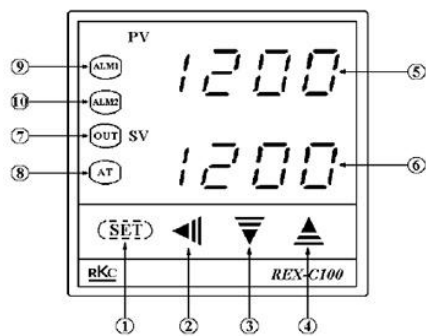

- ① Set (SET) key
- The set-value thus changed is entered
 - Parameters in the parameter setting mode are selected in due order.
 - Can select PV / SV display mode, SV setting mode, and parameter setting modes.
- ② Setting digit shift key
- Used when the cursor (brightly lit) is moved to the digit whose number needs to be changed for set-value change.
- ③ Set-value decrement key
- Used when the number needs to be decreased for set-value change.

- ④ Set-value increment key
- Used when the number needs to be increased for set-value change.
- ⑤ Measured-value (PV) display unit [Green]
- Displays measured-value (PV)
 - Displays a parameter symbol in the parameter setting mode.
- ⑥ Set-value (SV) display unit [Orange]
- Displays set-value (SV)
 - Displays set-value corresponding to the parameter symbol displayed on the measured-value (PV) display unit.

Control output (OUT) lamp [Green]

- Lights up when the control output is turned ON.

Auto-tuning (AT) lamp [Green]

- Flashes during auto-tuning.

First alarm (ALM1) lamp [Red]

- Lights up when the first alarm is turned ON.
- When a control loop break alarm (LBA) is selected as the first alarm, this lamp lights up.

Second alarm (ALM2) lamp [Red]

- Lights up when second alarm is turned ON.
- When either a heater break alarm (HBA) or control loop break alarm (LBA) is selected as the second alarm, this lamp lights up.

Hold down the SET button of bottom heater temperature control instrumentation for 5 seconds, the display will be blinking and using up/down buttons temperature of bottom heater. Using left arrow you can change one of four number positions.

The factory temperature is set is 180°C. Generally the user needn't to change the data.

2.4. Rework Operation Steps

1. Be all set

1.1. Fixed motherboard

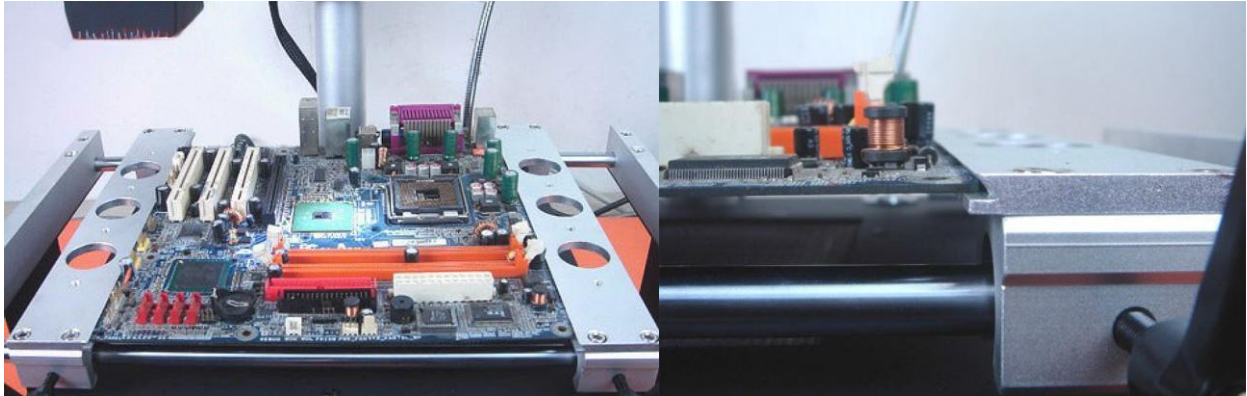

1.2. Shift sensor close to BGA chip.

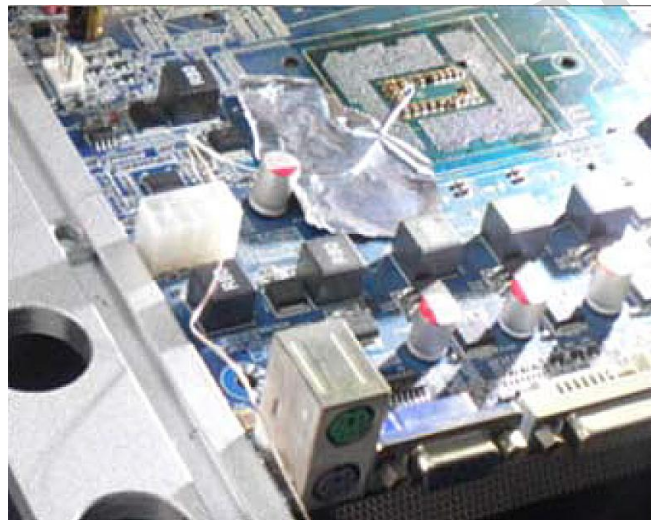

1.3. Adjust the height of heating head with adjustment knob

(Prompt: BGA chip in the middle of heating head, heating head away from BGA chip $\geq 2\text{cm}$)



2. Start heating

2.1. Select the appropriate temperature program segment, and then press the start switch. In the operation can press the stop switch, stop operating.



2.2. After the program runs, automatic alarm 8sec. and automatically cut off the heating power, this time you can check the following solder ball is completely liquefied, BGA chips should be subject to settlement, floating state .

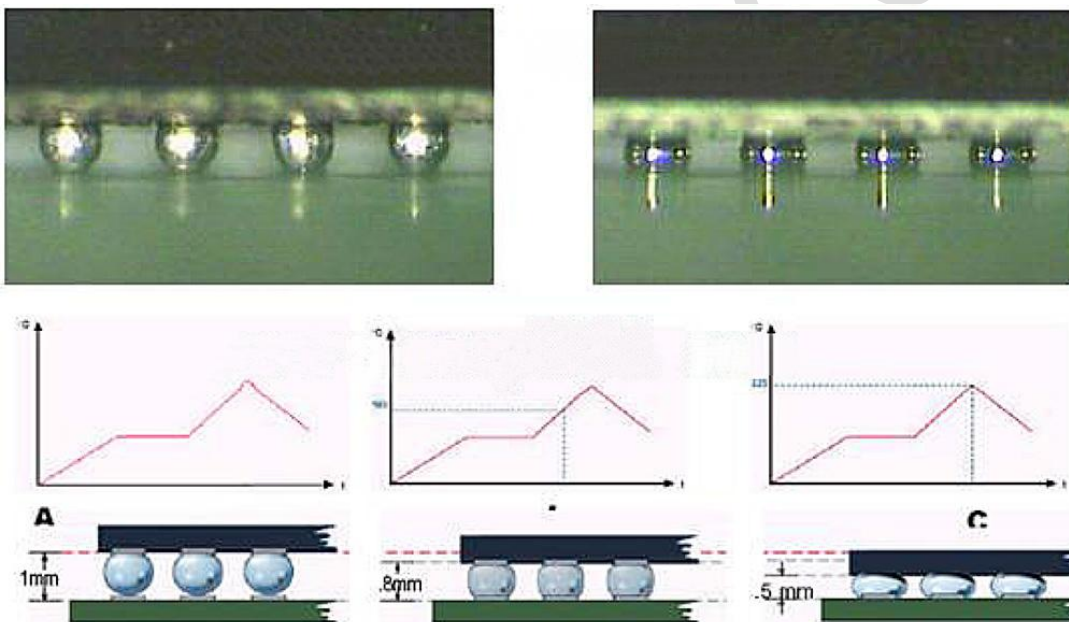

3. Rework completed

3.1. Moving Heating head and Sensor, open the Upper fan Switch.

3.2. Remove motherboard. Clear insulating tape.

3.3. BGA Rework Station Cooled, Then close Total Power.

Warning?

1. If BGA Rework Station NO Cooling, Do not close the Total Power !

2. When the temperature is not cooled, do not touch heating module!

Prompt

1. Keep the equipment at a steady working environment where the air mobility should be as small as possible. Avoid it closing to air conditioners, fans and the other outlet.
2. IR 6000 Rework Station sensor is directly contacted with motherboards, So the display temperature is Actual temperature.
3. In order to avoid damages to the motherboard capacitor, please use insulation tape. After Maintenance is completed, Remove the insulation tape to prevent from short-circuit.
4. After removal of BGA chip PCB bonding pad needs to be cleaned up, Avoid cold solder joint. See BGA chip tin completely liquefied, then move the BGA chip to avoid Bonding Pad Damage.
5. During the reflow of the new ball in a typical tin/lead (Sn63/Pb37) com position, there are "self alignment" properties that are quite forgiving. According to IPC Spec, landing on 75% of the pad is acceptable for BGA rework.
6. To improve success rate of Rework, PCB and chips need drying and processing in principle PCB board or chip moist heat process will occur in the burst phenomenon, the Rework process may hear the blasting sound of a minor. According to actual situation Please self-control.
7. PCB board heating time is too long or repeated several times the surface heating will lead to discoloration.
8. Users from modifying temperature parameters. Please use scrap PCB tested heating whole time about 10 seconds before the end of solder balls should be fully liquefied f the liquefaction advanced or delayed, should be regulating up/down the temperature setting. To prevent heat damage to your chips or low-temperature sealing off.
9. Common setting of temperature

Rework type	Bottom heating temperature	Upper Heating temperature
Normal Solder (Sn63 Pb37)	160°C	185°C
Lead-free (Sn96.5 Ag3 Cu0.5)	200°C	230°C
Reball (Sn63 Pb37)	NO	185°C

Reflow temp Sn63Pb37 : 185 - 190C, Reflow time: 10sec.

Reflow temp Sn96,5Ag3Cu0,5: 220 - 225C, Reflow time: 15sec.

10. The meaning of " Hb":

“Hb” means the max heating temperature of the upper heating. We set the max temperature at 230°C according to the max temperature of lead-free Rework and other technical reasons. The data needn't to be changed.

11.The meaning of “r1” “L1” “d1” “r2” “L2” “d2” “r3” “L3” “d3”

Please pay attention to The following pictures and tables:

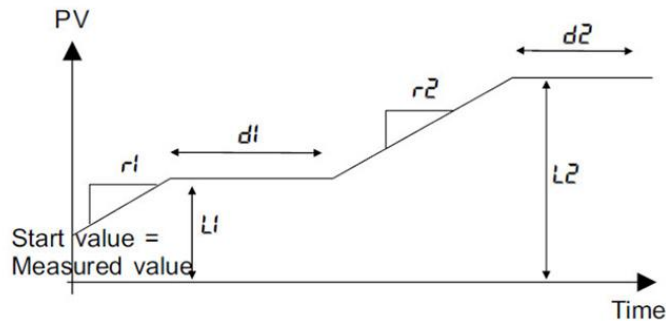

S.N.	Mnemonic	Parameter	Adjustable Range
1	r1	Ramp Rate 1	1
2	L1	Target Setpoint 1	0~230、End
3	d1	Dwell Time 1	0~9999sec
4	r2	Ramp Rate 2	1
5	L2	Target Setpoint 2	0~230、 End
6	d2	Dwell Time 2	0~9999sec
7	r3	Ramp Rate 2	1
8	L3	Target Setpoint 2	0~230、 End
9	d3	Dwell Time 2	0~9999sec
...
	Hb		230

12.IR6000 can be managed by dedicated software using RS232 cable.

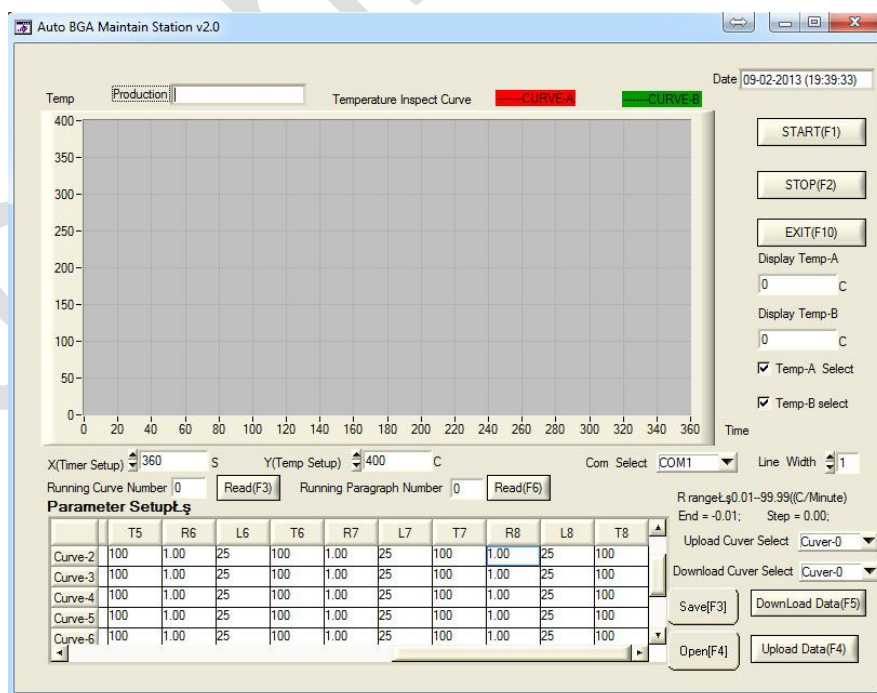

Rework temperature curve to set examples

1. Lead Sn63Pb37	slope/S	numeric al value °C	temperature °C	numeric al value °C	Temperature time S	numeric al value S
	r1	0.45	L1	85	d1	85
	r2	1	L2	150	d2	40
	r3	1	L3	185	d3	40
2. Lead-free Sn96.5Ag3Cu0.5	slope/S	numeric al value °C	temperature °C	numeric al value °C	Temperature time S	numeric al value S
	r1	0.45	L1	85	d1	92
	r2	1	L2	150	d2	40
	r3	1	L3	180	d3	40
	r4	1	L4	220	d4	40
3. Lead (Computer)	slope/S	numeric al value °C	temperature °C	numeric al value °C	Temperature time S	numeric al value S
	r1	0.5	L1	90	d1	90
	r2	0.85	L2	135	d2	45
	r3	0.8	L3	170	d3	40
	r4	1	L4	185	d4	45
4. Lead-free (Computer)	slope/S	numeric al value °C	temperature °C	numeric al value °C	Temperature time S	numeric al value S
	r1	0.45	L1	90	d1	90
	r2	1	L2	145	d2	40
	r3	1	L3	180	d3	50
	r4	1	L4	220	d4	45
5. For XBOX	slope/S	numeric al value °C	temperature °C	numeric al value °C	Temperature time S	numeric al value S
	r1	0.40	L1	90	d1	90
	r2	0.85	L2	135	d2	40
	r3	1	L3	170	d3	60
	r4	1	L4	220	d4	65
6. For PS3	slope/S	numeric al value °C	temperature °C	numeric al value °C	Temperature time S	numeric al value S
	r1	0.40	L1	90	d1	90
	r2	0.85	L2	135	d2	45
	r3	1	L3	180	d3	60
	r4	1	L4	220	d4	65