

Operational Manual

Super Power IR LED Illuminator & Professional Camera Housing

HI 7-TKHBL



7 IR LED

FEATURES

- 7 Super Power IR LED, 4pc x 25° / 3pc x 45°
- IR Distance up to 250ft / 80m ▲
- IP66 Rating
- User Adjustable IR LED Intensity (**VR**), Factory Default 80% ◆
- Fully-Cable Managed Mounting Bracket
- Uses professional rust-proof stainless steel screws
- Heater & Blower
- 24V AC, 60VA, Power Ready Plug for 12V DC Camera

HI 11-TKHBL



11 IR LED

FEATURES

- 11 Super Power IR LED, 6pc x 25° / 5pc x 45°
- IR Distance up to 395ft / 120m ▲
- IP66 Rating
- User Adjustable IR LED Intensity (**VR**), Factory Default 80% ◆
- Fully-Cable Managed Bracket
- Uses professional rust-proof stainless steel screws
- Heater & Blower
- 24V AC, 60VA, Power Ready Plug for 12V DC Camera

PART DESCRIPTION

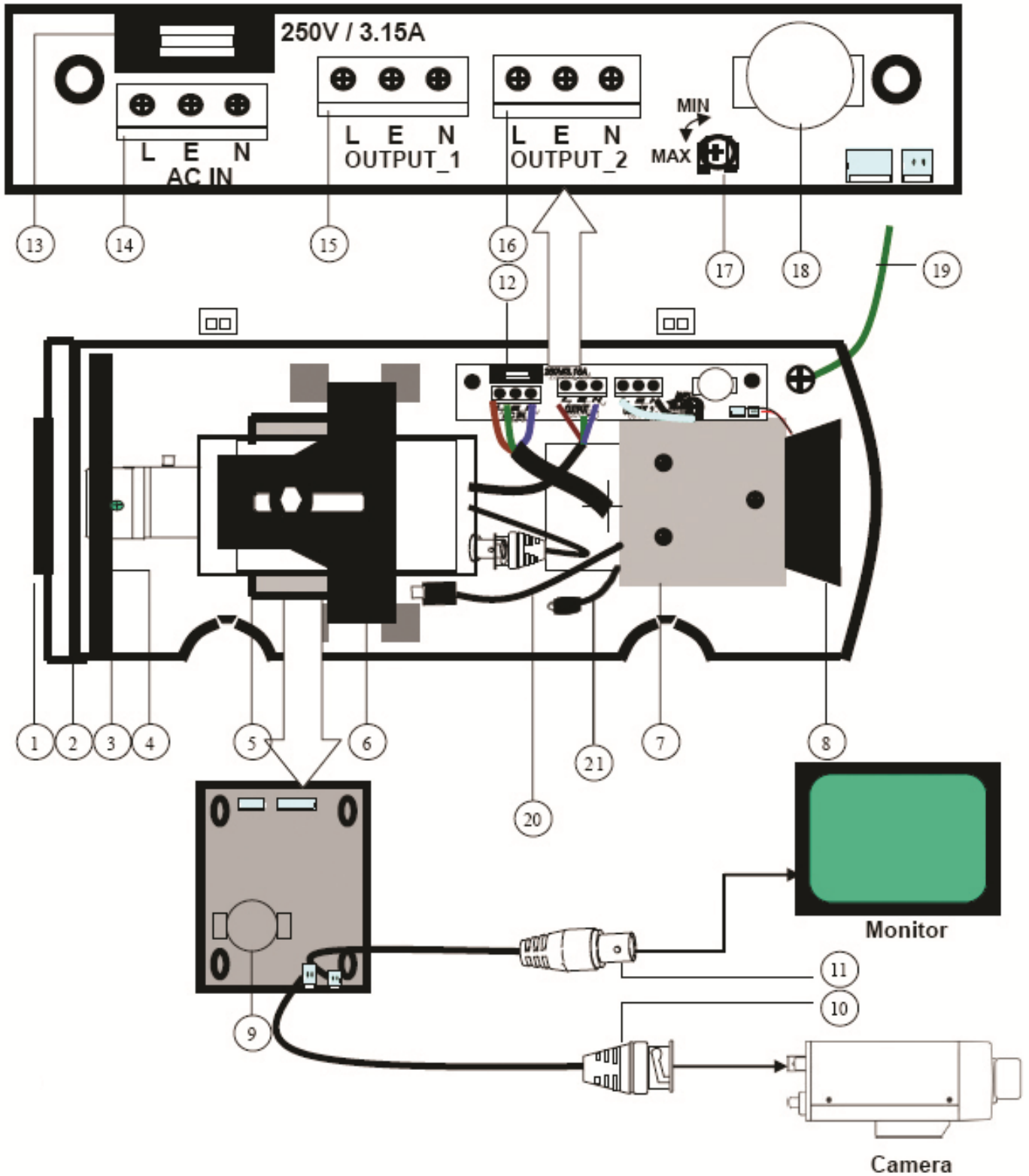

1. Lens Cap with Heater
2. Temper Glass
3. IR LED: 7pcs or 11pcs Super Power IR LED with Refractor
4. IR Board and IR Board Bracket
5. Universal IR Control Circuit Board: When the IR light turns on, it automatically adjusts the color to monochromatic through the universal IR control circuit.
6. Camera Bracket
7. Power Supply Unit: 24V AC input, 60VA
8. Blower and Blower Bracket
9. Thermostat Switch
10. Video Input BNC Male Connector: Connect to camera
11. Video Out BNC Female Connector: Connect to monitor
12. Terminal Board
13. Fuse Holder: With 250V / 3.15A fuse
14. AC IN Terminal block: 24V AC external power input
15. OUTPUT_1 Terminal block: Plug and fix the power cable of camera
16. OUTPUT_2 Terminal block: To power supply unit
17. VR: Adjust VR to set Infrared LED activation level
Factory default 80% -- If there is not enough IR light, adjust the level to maximum 100% ◆
18. Thermostat Switch: Turns on at 35°C / 95°F and turns off at 25°C / 77°F for Blower
19. Ground wire: To top cover
20. 12V DC Power-in jack: To camera / center+, outer-
When using a camera which requires a 24V AC power input, please run a separate power line to the camera
21. Flying Bare Lead Wire: When the wire is not in use, cover it with the screw-on connector or tape the tip with tape to prevent damages caused by the bare lead wire.

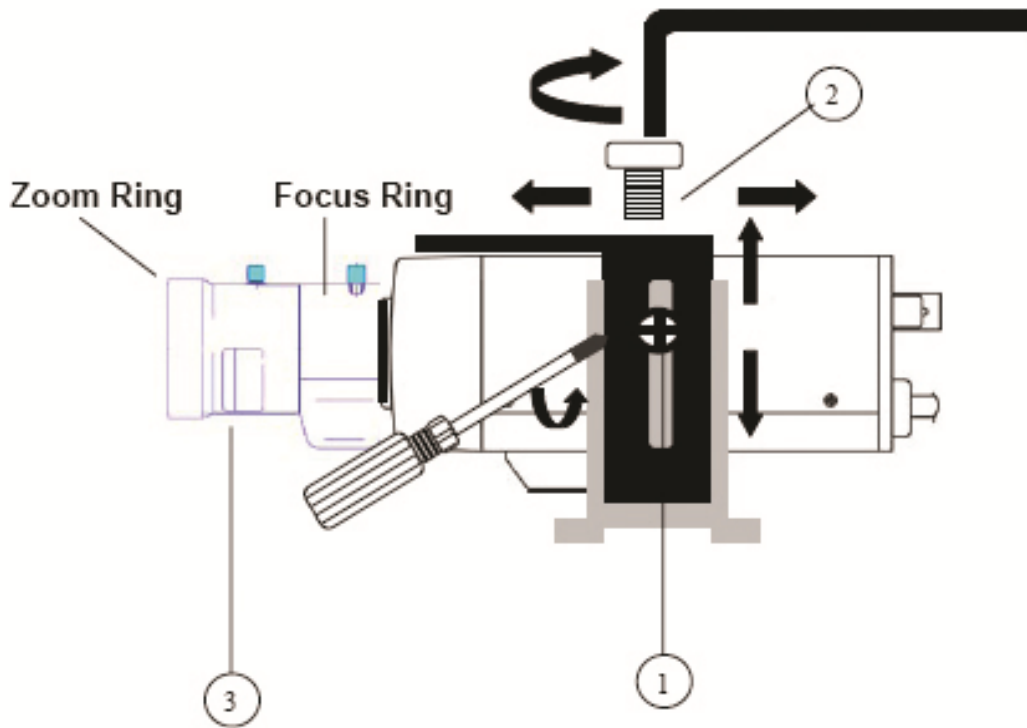

1. Loosen two screws on both sides of the camera bracket first.
2. Use the provided screw to fix the camera (not included) on the camera bracket.
3. Adjust zoom, focus and iris of the lens on the camera.
4. Adjust the direction of the camera for proper position, after finished tighten all screws.

How to install cables through the mounting bracket:

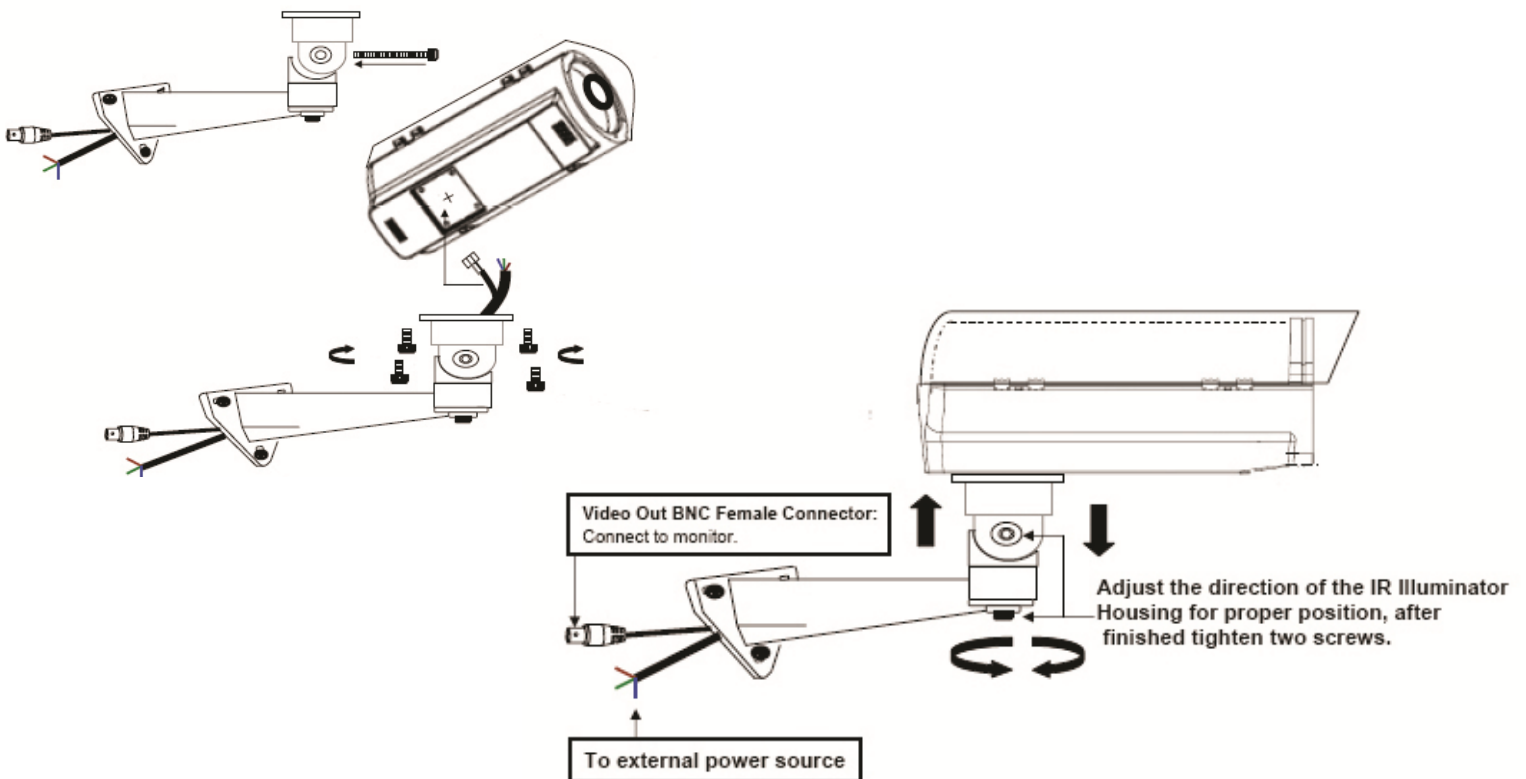

EXTERNAL POWER INPUT CONNECTION

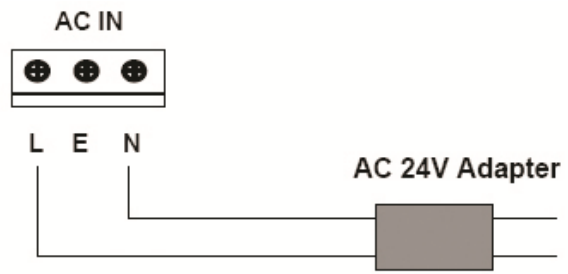
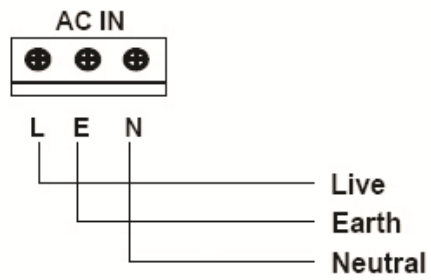

NOTE: When using two-cord power cable, please connect them to "Live" and "Neutral."

DIMENSIONS (mm)

HI7-TKHBL / HI11-TKHBL:

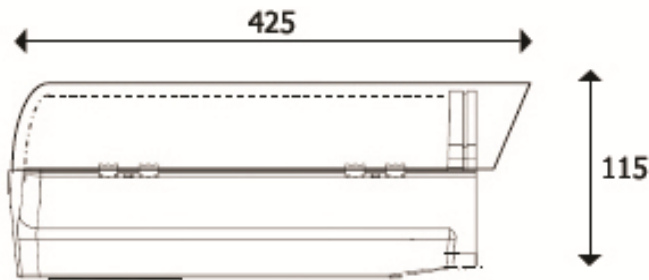

Fully-Cable Managed Bracket:

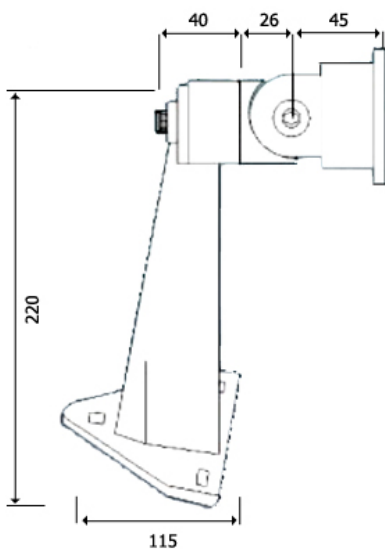

- Max Load: 3500g
- Material: Die-cast aluminum alloy with light ivory powder coated and stove finish
- Scan Angle: 180°
- Tilt Angle: 90°
- Net Weight: 900g
- Fixing: 3 Screws with bushings

GENERAL SPECIFICATIONS

Model	HI7-TKHBL	HI11-TKHBL
LED Quantity	7 Super Power IR LEDs	11 Super Power IR LEDs
IR LED Beam Angle	4pc x 25° / 3pc x 45°	6pc x 25° / 5pc x 45°
IR Wave Length	850nm	
IR Distance	250ft / 80m ▲	395ft / 120m ▲
IR Light On/Off	Auto Light Sensor Control	
Heater Control	18°C / 64°F (on); 28°C / 82°F (off)	
Blower Control	35°C / 95°F (on); 25°C / 77°F (off)	
IP Rating	IP66	
Temper Glass Thickness	4mm	
Mounting Bracket	Full-Cable Management	
Construction	Die-Cast Aluminum Alloy	
Coating	Ivory Powder Stove	
Required Power Supply / Transformer *	24V AC (+/-10%), 60VA	
Power Consumption	9 Watts	16 Watts
Dimension	16.73"(L) x 6.30"(W) x 6.50"(H) / 425mm(L) x 160mm(W) x 165mm(H)	
Camera Space	7.87"(L) x 4.33"(W) x 4.53"(H) / 200mm(L) x 110mm(W) x 115mm(H)	
Weight	7.72 lbs / 3500g (w/out bracket) 11.55 lbs / 5240g (with bracket)	7.72 lbs / 3500g (w/out bracket) 11.75 lbs / 5330g (with bracket)

* Power supply / transformer not included

▲ **NOTE 1:** IR light distances are entirely dependant upon environmental site conditions and the location at which the unit is situated. The type of camera being used is also very important.

◆ **NOTE 2:** Factory default for the IR LED activation level is 80%. If there is not enough IR light, adjust the **VR** level to maximum 100%. Please see #17 in the Part Description section on page 1.

PACKAGE CONTENTS

- One (1) HI7-TKHBL or HI11-TKHBL IR Illuminator & Professional Camera Housing
- One (1) Fully-Cable Managed Bracket
- One (1) Operational Manual
- One (1) Main Accessories Pack
 - Three (3) Rust-proof Stainless Steel Wall Screws
 - Three (3) Rust-proof Stainless Steel Mounting Screws
 - Three (3) Stainless Steel Washers
 - Three (3) Plastic Washers
 - One (1) Allen Wrench
- One (1) Secondary Accessories Pack
 - Three (3) Screw-on Connectors
 - One (1) Rubber Pad
 - One (1) Rust-proof Stainless Steel Camera Screw
 - One (1) Plastic Washer

* For any returns, please include all components listed above with original packaging in **Resalable Condition**. **Absolutely No Returns** will be accepted if any component is missing/damaged or if any cable is cut or tampered with.



WARRANTY

OKINA USA Products are covered under warranty for one year from the date of purchase. The warranty will automatically be voided if any of the following occurs:

1. Product sticker is removed

If the product sticker is removed, we will not be able to confirm any information regarding when and where the product was purchased. We have no other way to verify the purchase record without the serial number on the product sticker; therefore, it should not be removed.

2. Product is modified in any way

If the product is scratched, damaged, or modified in a manner not described in this manual, the warranty will be voided immediately. It is the customer's responsibility to keep the product in good condition.

3. Power cable is cut

The power cable and any other cable should not be tampered with. Cutting or modifying of the cables will result in termination of the warranty.



IMPORTANT NOTE

1. Read and follow instructions

All operating and user instructions should be read and followed before the unit is to be operated.

2. Secure all screws

Please make sure all rust-proof stainless steel screws are installed securely to ensure a waterproof seal.

3. Electrical connections

Only a qualified electrician should be allowed to make electrical connections.

4. Do not disassemble the product

Do not disassemble the product as it is dangerous and may cause damage to the product. Refer all servicing to qualified service personnel.

5. Handle the product with care

Be careful when handling the product. Do not drop it or subject it to strong shock or vibrations in order to prevent any damage to the product. Do not handle the product in a wet environment or when your hands are wet.

6. Reducing risk

To reduce risk of fire or electric shock, do not remove cover. Do not open product in wet weather. No user serviceable parts inside. Refer servicing to qualified service personnel.

7. Unpacking

Unpack carefully. Electronic components can be damaged if improperly handled or dropped. If an item appears to have been damaged during shipment, please place it properly in its carton and notify the shipper.

8. Installation notice

Tropical, coastal salt water environment:

If you plan to install this product into a tropical, sea, coastal salt water or corrosive industrial water/mist environment, please seal each stainless screw and fitting with a silicon grease compound. This will help prevent electrolysis corrosion occurring and extend the lifespan of the product and housing and prevent premature deterioration.

9. Voltage

If you are using a camera which requires a 24V AC power input, please run a separate power line to the camera.

Why PRO Series?

- Constructed from Heavy Duty Die-Cast Aluminum Alloy
- User adjustable IR LED intensity (VR)
- Uses professional rust-proof Stainless Steel Screws
- Fully-cable managed mounting bracket (except for IR7-TIR)
- IP66 rating or above on most products

High Resolution IR LED Day & Night Camera with ICR
SIV7-T54AI922

- 1/3" Sony Super HAD CCD, 540 TV Lines
- 7 Super Power IR LED, IR Distance 200~250ft / 60~80m
- 9.0mm~22.0mm Auto Iris ED-IR Lens
- Built-in IR Cut Filter Removable (ICR)
- 24V AC, 60VA



IR LED Illuminator with Housing & Bracket
HI7-TKHBL **HI11-TKHBL**

- 7 Super Power IR LED
- IR Distance up to 250ft / 80m
- 24V AC, 60VA

- 11 Super Power IR LED
- IR Distance up to 395ft / 120m
- 24V AC, 60VA



Housing & Bracket
Front Opening
HUB-TF
HUB-TFHB



- IP67 Rating
- Includes Heater & Blower for HUB-TFHB
- 24V AC, 40VA

Housing & Bracket
Side Opening
HUB-TS
HUB-TSHB



- IP68 Rating
- Includes Heater & Blower for HUB-TSHB
- 24V AC, 40VA

IR LED Illuminator Possible Applications:
IR7-TIR

- 7 Super Power IR LED
- IR Distance up to 150~200ft / 45~70m
- Includes 1 Side & 1 Underneath Mounting Plate
- 24V AC, 40VA



Ceiling Mount Adaptor
HUA-TCE



Corner Mount Adaptor
HUA-TCO



Pole Mount Adaptor
HUA-TPO

