

# Mico AP

## Infant Car Seat

To be used only in rearward facing position until the infant's shoulders reach marker (approx. 6 months of age.)

**IMPORTANT:** KEEP THIS BOOKLET IN THE PLACE PROVIDED ON THE CHILD RESTRAINT.

# Table of Contents

<b>Warnings</b> .....	<b>3</b>
<b>Parts list</b> .....	<b>6</b>
<b>Vehicle information</b> .....	<b>10</b>
Location of anchor fitting .....	<b>10</b>
Anchorage fitting installation .....	<b>11</b>
Upper anchorage fitting installation .....	<b>12</b>
Correct vehicle position .....	<b>15</b>
Vehicle seat location .....	<b>16</b>
Angle configuration for the seat .....	<b>17</b>
<b>Operation and adjustment</b> .....	<b>18</b>
Shoulder height marker .....	<b>18</b>
Preparing infant seat to fit your child .....	<b>19</b>
Removing child from child restraint .....	<b>26</b>
Adjusting handle .....	<b>26</b>
<b>Installation</b> .....	<b>27</b>
Base rearward facing installation .....	<b>27</b>
Lap sash / lap only base installation .....	<b>28</b>
Installing base using locking clip .....	<b>30</b>
Two-piece top tether strap fitment .....	<b>31</b>
Removing seat and detaching top tether strap .....	<b>32</b>
<b>Storing tether loop</b> .....	<b>33</b>
<b>Storing instruction manual</b> .....	<b>34</b>
<b>Lower connectors installation</b> .....	<b>35</b>
<b>Covers and accessories</b> .....	<b>44</b>
<b>Canopy use</b> .....	<b>45</b>
<b>Care and cleaning</b> .....	<b>46</b>
Remove seat cover for cleaning .....	<b>46</b>
Cleaning buckle .....	<b>48</b>
General maintenance .....	<b>50</b>
<b>The next seat for your child</b> .....	<b>51</b>
<b>Guarantee</b> .....	<b>55</b>



# WARNINGS

Read and follow all of the installation instructions for maximum protection. If you have any questions regarding the installation or use of this restraint, please contact Dorel Australia or agent, or a child restraint fitting station authorised by the relevant transport authority, or in New Zealand, to consult the agent for the vehicle.

## GENERAL

- To be used only in a rearward-facing position until the infant's shoulders reach the shoulder height marker (approximately 6 months of age). Continue to use this infant restraint until the child reaches this limit. Infants are at risk of serious injury if they face forward too early.
- Use the restraint exactly as shown in the instructions.
- Supervision of children is needed because they may be able to undo the buckles.
- **DO NOT LEAVE CHILDREN UNATTENDED IN THE CAR.**
- Do not alter or modify this restraint.
- Repairs must only be done by the manufacturer or agent.
- Do not allow the restraint to come into contact with polishes, oils, bleach and other chemicals.
- Destroy the restraint if it has been in a severe crash, even if no damage is visible.
- **DO NOT USE THIS RESTRAINT WITHOUT THE COVER.**
- To ensure infant's back is evenly supported, do not put more than one nappy on the baby and make sure the nappy is not thickly folded at the back.
- **DO NOT USE A REAR-FACING CHILD RESTRAINT WHERE AN AIRBAG IS FITTED IN FRONT OF THE SEATING POSITION.**
- Fit the restraint firmly to the car seat.
- Fit the harness firmly to the child.
- A loose restraint or harness is dangerous.
- Do not harness an infant wrapped in a blanket or swaddled. Any blanket or wrap must only be placed over the harness and infant.

# WARNINGS

- Care and attention should always be given to ventilation and shading of the child.
- Seatbelt extenders are not recommended to be used if the seatbelt is not long enough to secure the child restraint. If seatbelts are too short then advice should be sought from a child restraint fitter and their recommendations be considered before using a seatbelt extender.
- Always secure the loose end of the top tether strap. Do not use the child restraint where this strap may fall into a split in the seat back or off the side of the seat.
- **ALWAYS ATTACH HOOK AND REMOVE SLACK.**
- THIS RESTRAINT IS NOT SUITABLE FOR USE WHERE THE TOP TETHER STRAP MAY FALL INTO A SPLIT IN THE SEAT BACK OR OFF THE SIDE OF THE SEAT.
- THIS RESTRAINT MUST BE ATTACHED TO A CHILD RESTRAINT UPPER ANCHORAGE POINT IN THE CAR. REFER TO CAR OWNER'S HANDBOOK FOR LOCATION OF UPPER ANCHORAGE POINTS. REFER TO A CHILD RESTRAINT FITTING STATION IF NO UPPER ANCHORAGE POINTS ARE IN THE MOTOR CAR.
- Always check the measurements between the front of the seat back of the rear seat and all front seats in the car in which the child restraint is intended to be used, to ensure that the space is sufficient.
- TO BE USED WITH A LAP-SASH/LAP-ONLY SEATBELT IN THE FRONT/BACK OF MOST CARS WITH FORWARD FACING SEATS.
- The use of child restraints in the front seat may be restricted for children of specific ages by local legislation. Please check with your local legislation regarding any restriction for child restraint. If a car has two or more rows of seats, children under four must not travel in the front seat. If all seats, other than the front seats, are being used by children under seven years, children aged between four and six years (inclusive) may travel in the front seat, provided they use an approved child restraint or booster seat.



# WARNINGS

- This child restraint is not approved for use with any connectors that connect to the car's ISOFIX low anchorages.
- Use of aftermarket accessories (i.e. items not provided in the box with the child restraint), can reduce the safety provided by the child restraint and may cause injury or death. For approved aftermarket accessories please refer to page 10.
- Please contact Dorel Australia Customer Service with any questions or concerns (see page 44 for contact details).

**If your seat is fitted with lower connectors please note the following additional warnings:**

- **TO BE USED WITH A LAP-SASH / LAP-ONLY SEATBELT OR ISOFIX LOW ANCHORAGES IN THE FRONT / BACK OF MOST CARS WITH FORWARD FACING SEATS.**

## **IMPORTANT:**

Do not attach the lower attachment connectors of two separate child restraints to the same ISOFIX low anchorages in your car.

Always attach the top tether strap to the child restraint upper anchorage in your car.

## Parts list

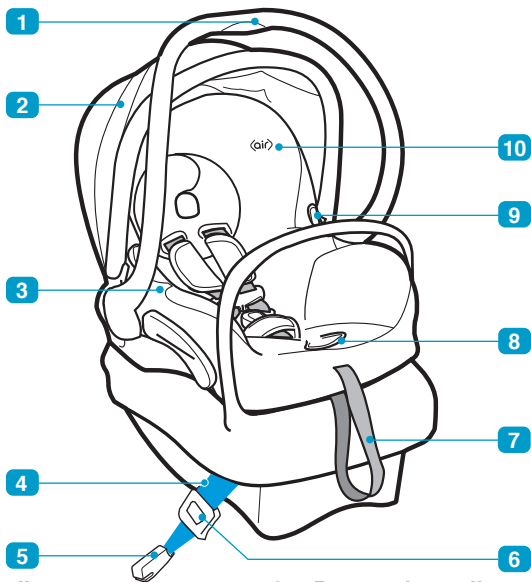

**1 Carry handle**

**2 Canopy**

**3 Instruction manual storage**  
*(under the pad)*

**4 Lower connector strap**  
*(if fitted)*

**5 Lower connectors (x2)**  
*(if fitted)*

**6 Pretension adjusters (x2)**  
*(if fitted)*

**7 Harness tightening strap**

**8 Harness release lever**  
*(under flap)*

**9 Stroller release buttons (x2)**

**10 Air protect cell (x2)**

## Parts list

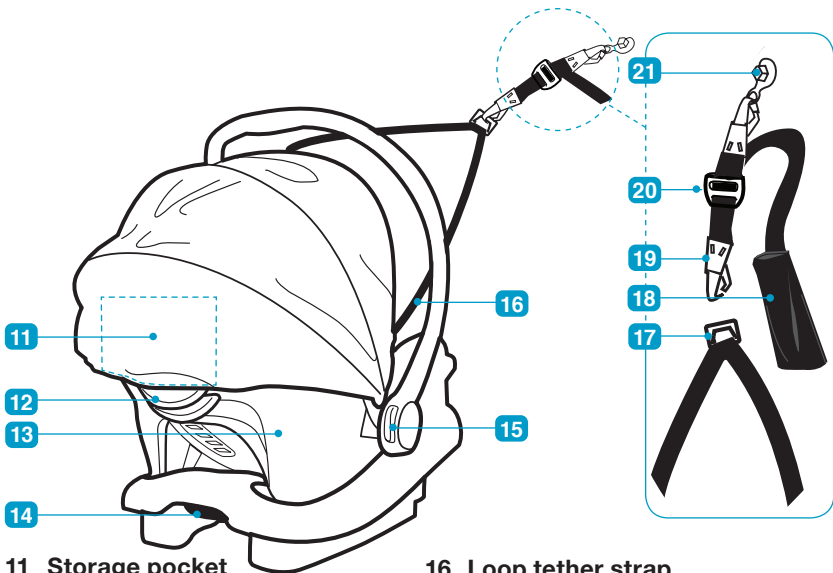

**11 Storage pocket**

*(inside canopy)*

**12 Seat release lever**

**13 Seat shell**

**14 Base adjustment handle**

*(2 positions)*

**15 Handle adjustment buttons**

*(3 positions)*

**16 Loop tether strap**

**17 Top tether metal connector**

**18 Top tether storage pocket**

**19 Top tether attachment hook**

**20 Top tether adjuster**

**21 Anchor kit**

## Parts list

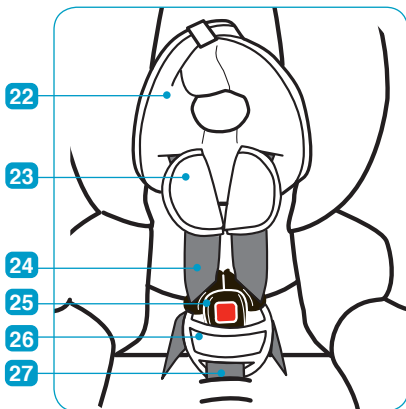

- 22 Infant head insert
- 23 Harness covers
- 24 Harness straps
- 25 Buckle
- 26 Buckle cover

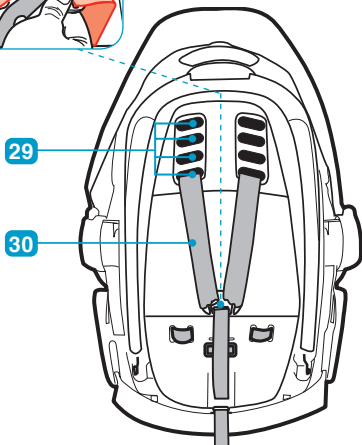
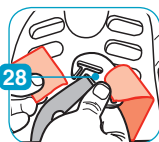

- 27 Buckle strap
- 28 Splitter plate
- 29 Harness slots (x4)
- 30 Harness straps



## Parts list

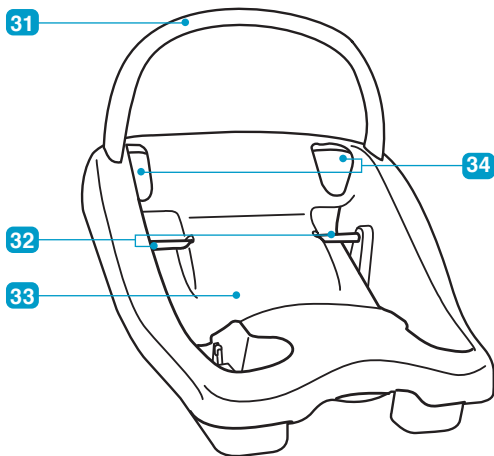

- 31** Stabilising bar
- 32** Locking bar
- 33** Base
- 34** Base belt path opening

## Vehicle information

### Location of anchor fitting

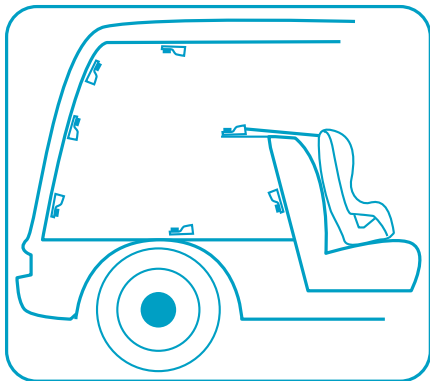

#### NOTE :

- The anchor point can be found in different locations in different cars. The illustration above shows possible locations of anchor points. Sometimes it is on the parcel shelf in sedans, and on the floor area in station wagons, vans and hatchbacks. Make sure that you do not confuse the luggage hook in the back of a station wagon with anchor points. Refer to your owner's manual.
- An extension strap may be needed for vehicles without a fixed parcel shelf. Extension straps and extra fittings are available from various stores.

Extension straps 300mm ref no. 014398	Extension straps 600mm ref no. 014399
Anchor bolt kit ref no. 014400	Locking clip ref no. 014401

## Vehicle information

### Anchorage fitting installation

Child restraints must be used correctly to provide proper protection for your child. The anchorage system on child restraint must be used in the correct way.

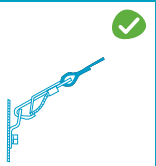
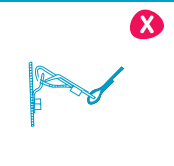
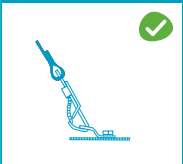
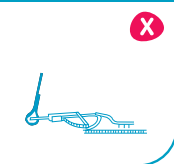
	✔	✘
INSTALLATION	CORRECT	INCORRECT
<b>Figure 1.</b> Anchorage in vertical panel at rear of vehicle	✔ 	✘ 
<b>Figure 2.</b> Floor mounted anchorages	✔ 	✘ 

## Vehicle information

### Upper anchorage fitting installation

#### FOR CARS FITTED WITH A CHILD RESTRAINT UPPER ANCHORAGE POINT

Locate the upper anchorage point behind the rear seating position (consult the car owner's handbook for the location of the upper anchorage point).

Remove the thread plug from the parcel shelf/floor/roof and install the attachment bolt as shown in **Figure 1**.

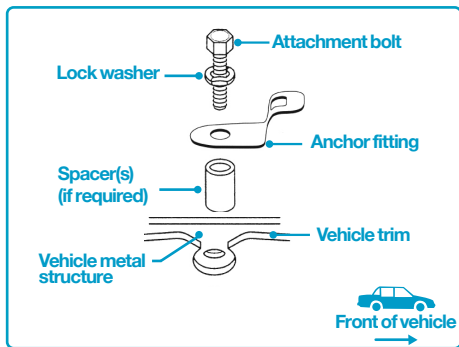

Figure 1

**CAUTION: DO NOT OVERTIGHTEN THE ATTACHMENT BOLT. MAXIMUM TORQUE 20 Nm.**

## Vehicle information

Upper anchorage fittings for sedans only

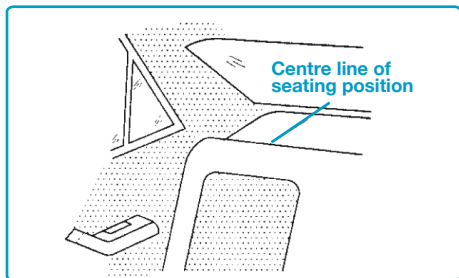

Figure 2

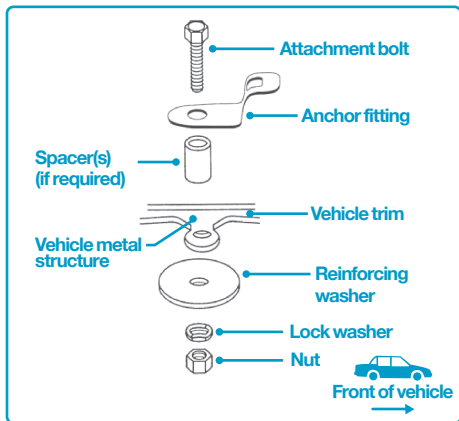

Figure 3

## Vehicle information

### Upper anchorage fitting installation

#### **For sedans only**

Drill a 9 mm diameter hole in the parcel shelf on the centre-line of the seating position as shown in **Figure 2**. Install the anchor bolt as shown in **Figure 3**. It is recommended that this installation be carried out by a child restraint fitting station or licenced motor mechanic.

#### **For vehicles other than sedans**

In Australia, consult your nearest child restraint fitting station or traffic authority for vehicle inspection to find the best, correct position for the placement of the upper anchorage point, and for the correct attachment bolt length and use of spacers. In New Zealand, consult the agent for the vehicle.

**WARNING: CHILD RESTRAINTS MUST NOT BE ATTACHED TO UNSOUND METAL OR TO WOOD, OR SYNTHETIC STRUCTURES. WHEN DRILLING THE 9 mm HOLE DO NOT DRILL THROUGH FUEL LINES, FUEL TANKS, ELECTRICAL WIRING, OR RADIO SPEAKERS. WEBBING STRAPS MUST BE PROTECTED FROM SHARP CORNERS AND EDGES.**

**THE ANCHOR FITTING MUST BE USED ONLY AS DESCRIBED ABOVE. IT MUST NOT BE HOOKED ONTO ANY OTHER OBJECT.**

## Vehicle information

Correct vehicle position

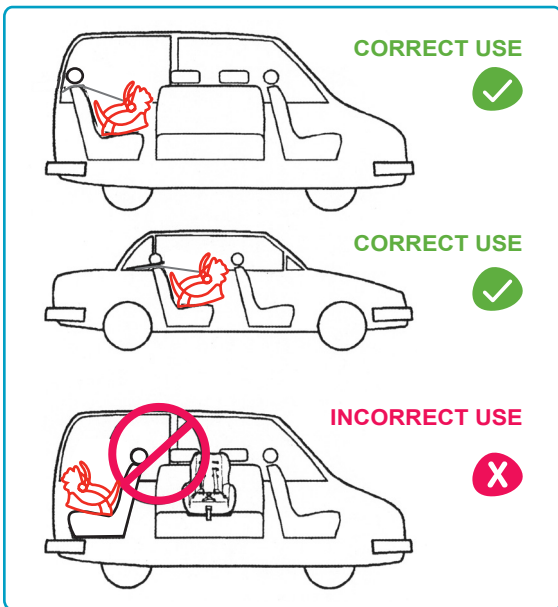

## Vehicle information

### Vehicle seat location

Some seating positions in your vehicle may **NOT** be safe for this safety seat. Some vehicles do not have any seating positions that can be used safely with the seat. If you are not sure where to place the infant seat in your vehicle, consult your vehicle's owner's handbook.

### Vehicle Seat Location Requirements

Children are safer when properly restrained in rear vehicle seating positions. Whenever possible, secure the infant seat in the centre position of the seat directly behind the front seats.

## **WARNING**

**IMPROPER PLACEMENT OF THE SAFETY SEAT  
INCREASES THE RISK OF SERIOUS INJURY OR DEATH.**

### NOTE :

Check the measurements between the front of the seat back of the rear seat and all front seats in the car in which the child restraint is intended to be used, to ensure that the space is sufficient.

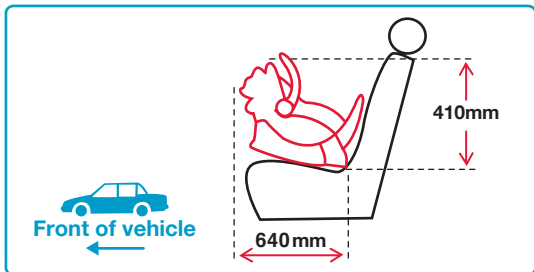



## Vehicle information

### Angle configuration for the seat

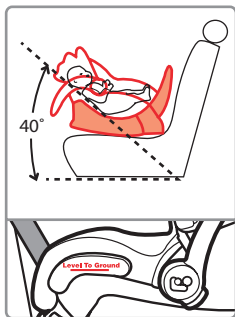

- Position seat ensuring that the angle is no greater than 40° from horizontal plane.
- Angular adjustment is achieved by adjusting the base. Make sure the line indicator is level to ground (refer to page 19.)

## WARNINGS

- **DO NOT** install convertible child restraints excessively reclined, ensure the angle is no greater than 40°.
- **DO NOT** adjust harness or tether strap hardware such that it sits too close to the occupant.
- Ensure that correct seatbelt path is used and that the restraint is installed in the correct direction for rearward-facing application. Refer to page 19.
- **DO NOT** wrap baby in a blanket or swaddled as infant can be ejected and killed in an accident.
- Ensure the harness fits the baby firmly.
- Ensure that any blanket or other covering may only be placed over the harness after the harness is adjusted firmly.
- The infant's legs and arms are not to be bound or wrapped together.
- Always adjust the height of the shoulder straps as the child grows.

## Operation and adjustment

### Shoulder height marker

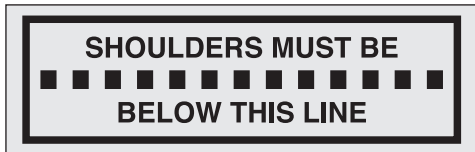
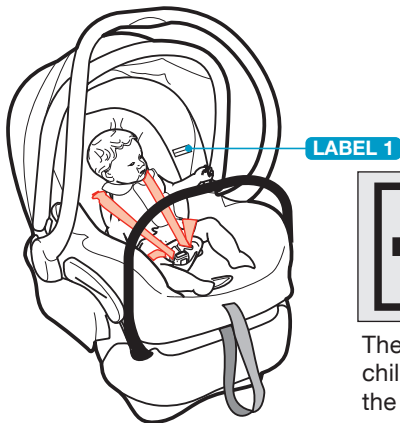

The child restraint is not suitable for the child when the child's shoulders are above the shoulder height maker.

## WARNINGS

- To be used only in a rearward-facing position until the infant's shoulders reach the shoulder height marker (approximately 6 months of age).
- Continue to use this infant restraint until the child reaches this limit. Infants are at risk of serious injury if they face forward too early. For information regarding the next seat for your child, refer to page 49.
- The child restraint is not suitable for the child when the child's shoulders are above the shoulder height marker.

### NOTE :

- If the baby's neck muscles are unable to support their head, then the child should remain rear facing.

## Operation and adjustment

Preparing infant seat to fit your child

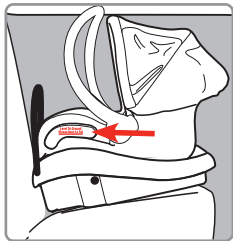

**You MUST make these adjustments before you installing the child restraint in the vehicle.**

- Place the child restraint in the car and see if seat is level to ground. The line should run parallel to the seat.
- Adjust base if needed. Follow the steps below.
- Remove the seat from the base by squeezing the seat release lever, then lift the seat up and off the base.
- Squeeze the base adjustment handle and either lift or lower front of base to the desired position.

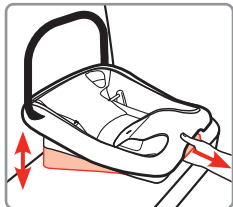
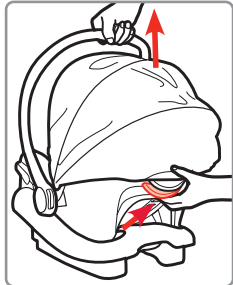

## Operation and adjustment

Preparing infant seat to fit your child (*cont'd*)

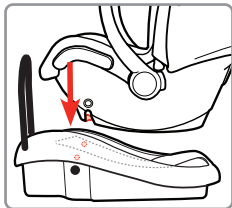

- Align the slots on the side of child restraint with the locking bars in the base.
- Push down firmly on the carrying handle and front of the child restraint will lock to the base.

**Listen for click.**

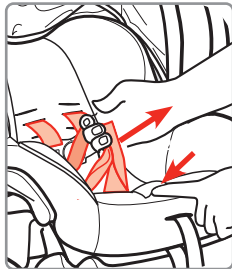

- To loosen harness, push down and hold on the **harness release lever** (under flap - **see pg 6 feature 5**).
- Pull on one harness strap or both harness straps simultaneously while pressing down on the harness release lever.

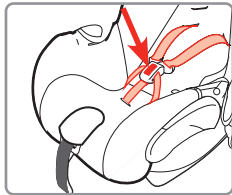

- Press red button to undo buckle.
- Pull buckle tongues out.
- Place harness straps over sides of child restraint.

## Operation and adjustment

Preparing infant seat to fit your child (*cont'd*)



- Child should be in rearward position as shown.
- Place the child's bottom and back flat against the child restraint. This will increase comfort and allow the harness straps to be properly tightened.

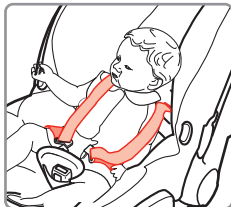

- Check harness height. The shoulder straps must be in the slots which are nearest to the child's shoulders, but not lower than the child's shoulders.

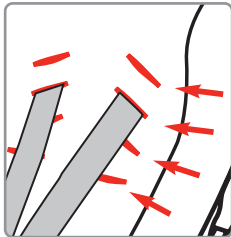

- To change the harness height, Determine which set of harness slots works best for your child and adjust if needed.
- Always adjust the height of the shoulder straps as the child grows.

## Operation and adjustment

Preparing infant seat to fit your child (*cont'd*)

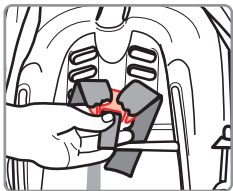

- If harness adjustment is required, locate splitter plate at rear of seat.

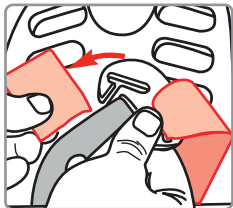

- Remove harness straps from splitter plate at rear of seat.

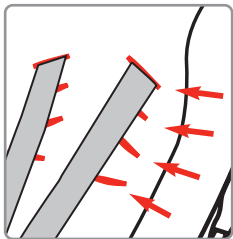

- Pull harness through the harness slots from the front.
- Re-thread harness into new harness guide locations.

**NOTE:** Do not use shoulder straps of unequal heights. Straps must be threaded through the same slot level for the trim and seat

## Operation and adjustment

Preparing infant seat to fit your child (*cont'd*)

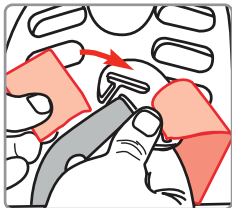

- Refit harness to splitter plate.

**NOTE:** Make sure harness is securely on and there are no twist.

- Place child in the restraint and position harness straps over the child's shoulders.

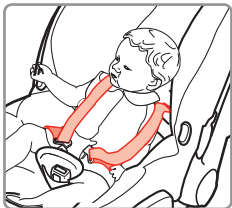

- To tighten the harness, fasten buckle and listen for the click when the second tongue goes in.

**NOTE:** When using the buckle please note that you will not hear a click when the first tongue goes in, it is only on the second tongue.

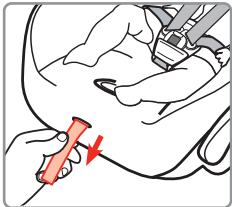

- Pull the adjustment strap at the front of the seat until the harness belt lies firmly against the child.

- **WARNING: DO NOT LEAVE CHILDREN UNATTENDED IN THE CAR.**

## Operation and adjustment

Preparing infant seat to fit your child (*cont'd*)

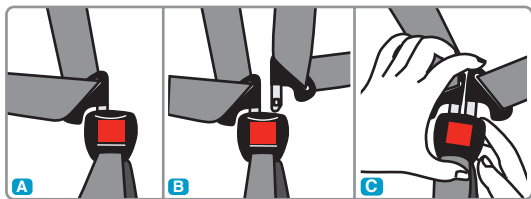

- A** Insert one buckle tongue as shown above.
- B** Insert the second buckle tongue as illustrated above.
- C** Press both tongues simultaneously. Listen for click.

### **NOTE :**

**Remember to always pull up on the harness straps to make sure buckle is locked.**



## Operation and adjustment

Preparing infant seat to fit your child (*cont'd*)

### NOTE :

A firm strap should not allow any slack. It lies in a relatively straight line without sagging. It does not press on the child's flesh or push the child's body into an unnatural position.



- Check the harness tightness by pinching the harness at the shoulders. If you can pinch the harness strap, tighten more. If your fingers slip off, the harness is tight enough.

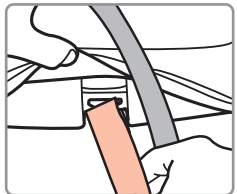

- Pull up the fabric cover at the front of the seat shell.
- The end of the harness adjustment strap has a loop. Slide one side of the loop onto one tab and the other end on the other tab.
- Replace the trim cover over the front of the shell.

## Operation and adjustment

### Removing child from child restraint / adjusting handle

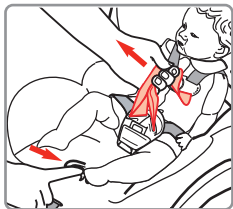

- To loosen, push down on the harness release lever (under flap on the front of child restraint), while pulling on both harness straps above the buckle.
- To unbuckle, press red button on buckle to release the buckle tongues.
- Move harness away from child and remove child.

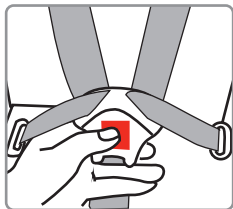

- The carrying handle has 3 positions. To adjust handle, press both adjustment levers on each side of handle. Rotate up or down to desired location.
- Release levers. Listen for click.
- Make sure both sides are locked into place.

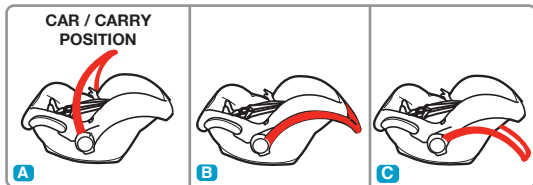
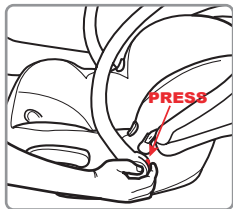

## Installation

Base rearward facing installation



## REARWARD FACING BELT PATH

REARWARD-FACING (Newborn to 6 months)

### OPTION 1 LAP SASH BELT PATH



### OPTION 2 LAP BELT PATH

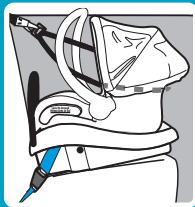

## Installation

### Lap sash / lap only base installation

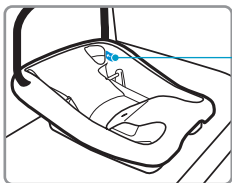

#### REARWARD FACING BELT PATH

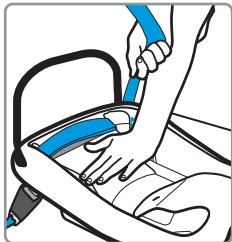
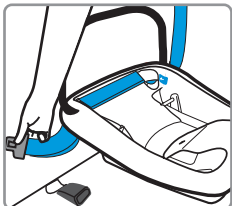

- Install base facing backwards, with the stabilising bar against the back of the car seat.
- Determine if base adjustment is required (refer to steps on pages **19 - 20**)
- Thread the vehicle lap or lap/shoulder belt combination through belt path as shown.
- Thread the vehicle lap or lap/shoulder belt combination through belt path as shown.
- Buckle vehicle belt. Push down firmly on the base and pull up on the belt to tighten. Pull up on shoulder strap to remove any slack.

## Installation

### Lap sash / lap only base installation

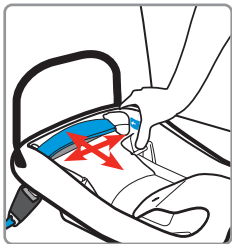

- With weakest hand at belt path, tilt and push the base forward and back, and from side to side.
- If the seat belts do not loosen, your child restraint should be secure.

**NOTE:** Some movement from front to back or from side to side is acceptable.

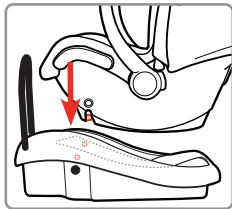

- With child secured in child restraint, attach to base.
- Align the slots on the side of child restraint with the locking bars in the base.

- Push down firmly on the carrying handle and the front of the child restraint to lock child restraint to base. You will hear a **click** when it is locked.
- Pull up on child restraint's front two corners to make sure the front of the child restraint is locked to the base.

## Installation

(Optional)

Installing base using locking clip



- Install the base with the stabilising bar against the back of the car seat.
- Thread the vehicle lap sash belt combination through the belt path. Lock tongue into buckle and listen for click.
- Push down firmly on the base and pull up on shoulder belt until all slack is removed and lap belt is tight.

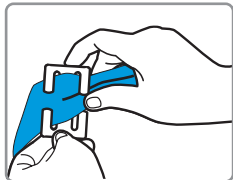

- Grasp both vehicle belts together and unbuckle.
- Thread both portions of the vehicle belt onto the locking clip on the opposite side of the buckle. Re-buckle belt.
- Lap belt portion should now be tight. If not, remove locking clip and repeat all steps.

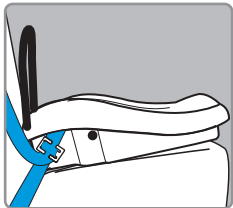

**NOTE:** The locking clip must be removed when the child restraint is not installed to allow other users to use the seatbelt as a lap-sash seatbelt. The locking clip shall not create unacceptable slack in the seatbelt.

## Installation

### Two-piece top tether strap fitment

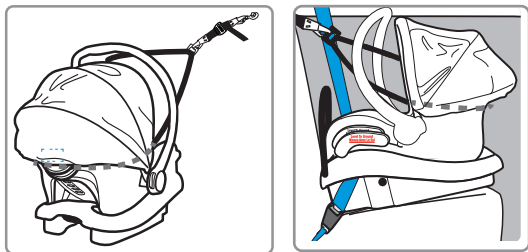

- Attach the hook to anchor in vehicle.
- Adjust tether strap to remove slack in strap (Pull on free end of webbing to tighten).
- Make sure the base is not lifted from the car seat.

## WARNINGS

**CAUTION:** CHILDREN CAN BE INJURED OR RESTRAINTS AND TOP TETHER STRAP DAMAGED BY UNSECURED CARGO IN A COLLISION. SECURE OR REMOVE HAZARDOUS CARGO BEFORE USING THIS CHILD RESTRAINT.

- Always secure the loose end of the top tether strap to prevent it hanging out of the car or being accessible by the child.
- When not in use, fold hanging tether strap and place in the storage pocket provided.

## Installation

### Removing seat and detaching top tether strap

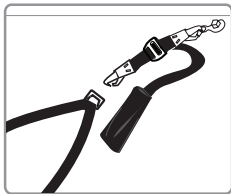

- Loosen the top tether strap using the adjuster and unhook the top tether strap from the loop section.
- Leave the tether attached to the anchor point in car.
- From the back of the child restraint, slide the base release handle up the back of the child restraint and lift the restraint out of the base.

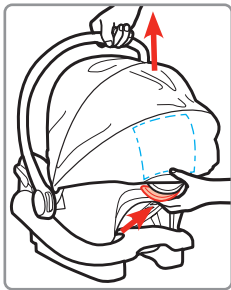

## WARNINGS

**WHEN NOT IN USE, FOLD TOP TETHER STRAP AND PLACE IN THE STORAGE POCKET PROVIDED.**



## Installation

### Storing tether strap

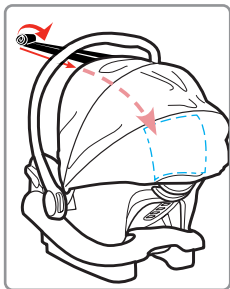

After detaching the top tether strap, roll the loop tether strap back towards the child restraint, and store it in the storage pocket located inside the canopy.

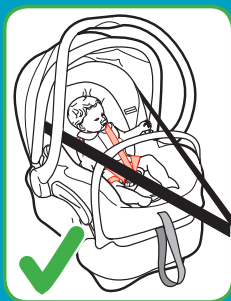
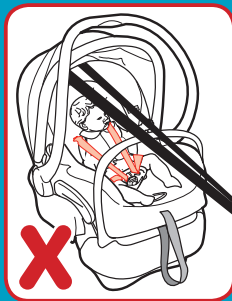

When removing the loop tether strap from the storage pocket, **DO NOT** pull the strap directly across the child restraint. Instead, be sure to evenly spread the loop tether around the side, in line with the shoulder height markers.

## Installation

### Storing instruction manual

#### STORING INSTRUCTION MANUAL

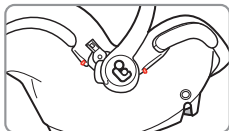

- Lift the cover to find instruction pocket.
- Place the instruction manual in the pocket provided under trim.

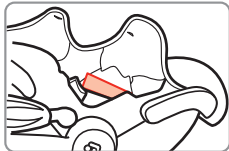

- Re-attach the cover.

## Lower connectors installation

(if fitted)

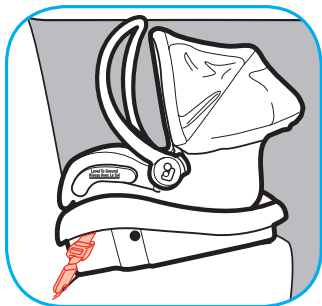

LOOK FOR THESE SYMBOLS FOR  
ATTACHMENT IN VEHICLE



ISOFIX



### WARNINGS

- Never place a child rear-facing in a seating position with an active frontal airbag. This can result in serious injury or death.
- This child restraint must always face the rear of the vehicle when installed.

## Lower connectors installation

(if fitted)



### PREPARING TO INSTALL BASE WITH LOWER CONNECTORS

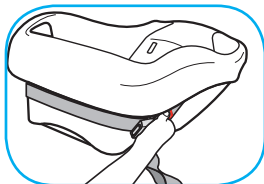

- Unhook lower connectors on both the right and left side of the base by pressing the red release button on each connector.

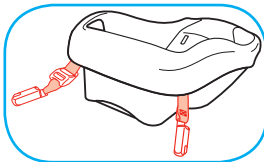

- Ensure that each connector is threaded through the rearward facing belt path as shown.

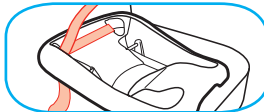

**NOTE:** Loose end of the lower connector strap **MUST** be on the left side of child restraint to ensure that the belt lays flat for correct installation. **DO NOT** twist belts.

## Lower connectors installation

(if fitted)



### INSTALLING BASE WITH LATCH

See your vehicle owner's manual for information on designated lower connector positions, anchor locations and anchor weights.

### WARNINGS

- **Do not use the lower connectors along with the vehicle lap or lap/shoulder belt.**
- **Check lower connector strap before each use. Use only if the strap can be tightened properly and securely.**
- **Failure to follow these warnings can result in serious injury or death.**

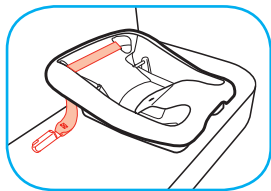

- Centre the base between the vehicle anchors in the chosen seating position.
- Fasten one lower connector to the anchor in the vehicle seat located in the vehicle seat bight. Repeat for the other side of base.

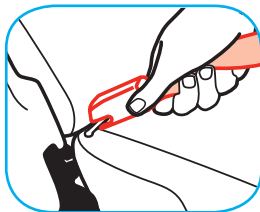

## Lower connectors installation

(if fitted)



- Push down firmly on the base and pull up on the free end of belt to tighten. The belt will display green when tight.

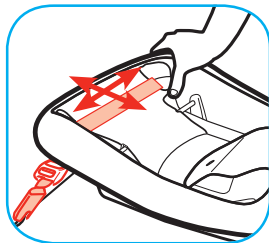

- **Grasp the base at the belt path** with one hand. Push and pull the base from side to side, forward and back. The base should be locked into a firm, snug fit with little movement.

**NOTE:** If base moves, try reinstalling the base or try another seating location.

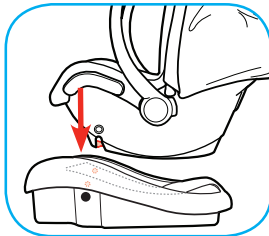

- With child secured in child restraint, attach to base. Align the slots on the side of child restraint with the locking bars in the base. Push down firmly on the carrying handle and the front of the child restraint to lock child restraint to base. You will hear a “click” when it is locked. Pull up on child restraint’s front two corners to make sure the front of the child restraint is locked to the base.

## Lower connectors installation

(if fitted)

### **WARNING**

Failure to securely attach child restraint to base can result in serious injury or death.

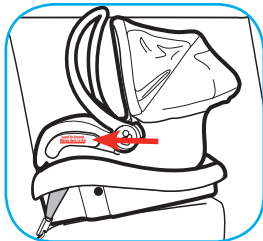

- Make sure level line on side of child restraint is level with ground. Adjust base if needed (see page 19).
- You may need to place a large rolled towel(s) or foam pool noodle(s) under the front of the base to achieve correct recline angle.
- Check often to be sure padding is still in place, the level line is still level and the belt is tight.

**NOTE:** The carrying handle can be in any position when installed in the vehicle.

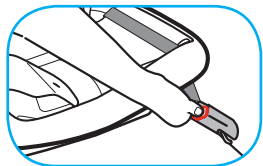
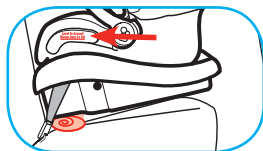

- Remove lower connectors from vehicle anchors by pressing the red release button on each connector.

## Lower connectors installation

(if fitted)



### INSTALLING BASE WITH VEHICLE BELTS

#### WARNINGS

- Do not use the lower connectors along with the vehicle lap or lap/shoulder belt. Store lower connector strap when using the vehicle belts.
- Check the vehicle belt before each use. Use only if the belt is tightened properly and securely.
- Failure to follow these warnings can result in serious injury or death.

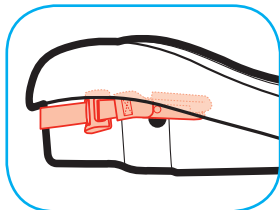

- You **MUST** store the lower connector strap when using the vehicle seat belts. Store strap by connecting the lower connectors to side of base as shown.

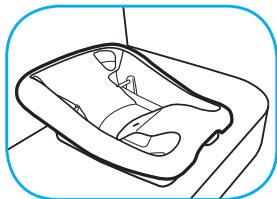

- Centre the base in the chosen seating position.



## Lower connectors installation

(if fitted)



- Thread the vehicle lap or lap/shoulder belt combination through belt path as shown. With an ALR belt, pull the belt all the way out before threading the base.



- Push down firmly on the base and pull up on the shoulder belt to tighten.
- With a switchable retractor, pull the vehicle shoulder belt all the way out to witch the retractor into the ALR mode before tightening. Feed the slack into the retractor while tightening.

## Lower connectors installation

(if fitted)

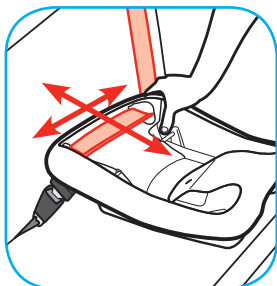

- **Grasp the base at the belt path** with one hand. Push and pull the base from side to side, forward and back. The base should be locked into a firm, snug fit with little movement.

**NOTE:** If base moves, try reinstalling the base or try another seating location.

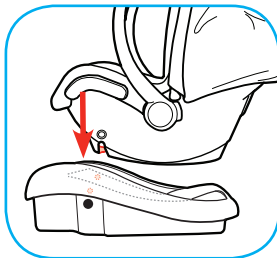

- With child secured in child restraint, attach to base. Align the slots on the side of child restraint with the locking bars in the base. Push down firmly on the carrying handle and the front of the child restraint to lock child restraint to base. You will hear a “click” when it is locked. Pull up on child restraint’s front two corners to make sure the front of the child restraint is locked to the base.

## Lower connectors installation

(if fitted)

### **WARNING**

**Failure to securely attach child restraint to base can result in serious injury or death.**

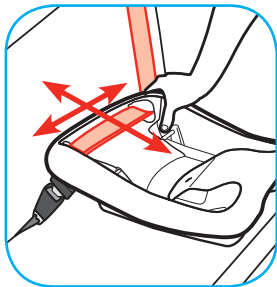

- Make sure level line on side of child restraint is level with ground. Adjust base if needed (see page 19).
- You may need to place a large rolled towel(s) or foam pool noodle(s) under the front of the base to achieve correct recline angle.
- Check often to be sure padding is still in place, the level line is still level and the belt is tight.

**NOTE:** The carrying handle can be in any position when installed in the vehicle.

## Covers and accessories

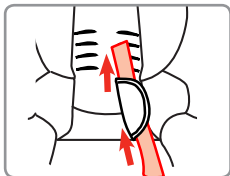

**NOTE:** Before fitting covers, remove harness from splitter plate (see page 22).

- Thread harness straps through harness covers.

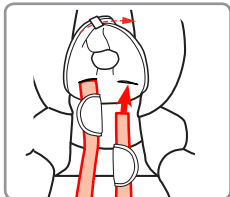

- Place infant head insert over harness slots, aligned with the appropriate slot for your child's shoulder height (see page 21.)

- Fit end of infant head insert through band on other side, securing the loop.

- Thread harness straps through slots on infant head insert, and continue through harness slots.

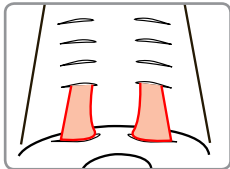

**NOTE:** Refit splitter plate before continuing (see page 23).

- Thread harness buckle through buckle cover, ensuring that the largest side is facing the child's crotch.

- Tuck end of buckle cover in through buckle slot, securing the cover in place.

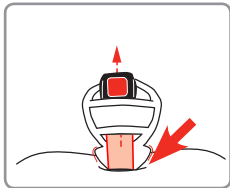

## Canopy use

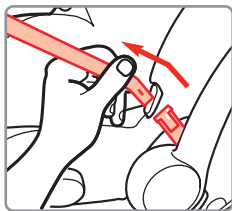

- The canopy hoop has an angle that will make the canopy lean forward when installed. Make sure when you thread the canopy hoop, the angle is correct.

- Thread plastic strip completely through channel on the front edge of canopy

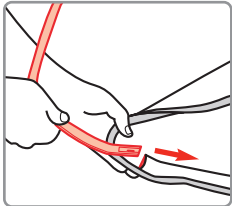

- Fit back of canopy over back of shell.

- Snap each plastic strip end to each canopy post.

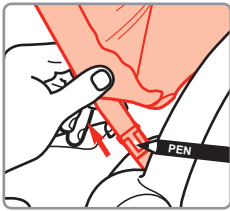
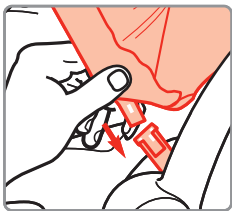

- **To remove canopy:** Use a pen or any pointed object to push the small tab as illustrated and simultaneously pull the plastic strip.

## Care and cleaning

Remove seat cover for cleaning

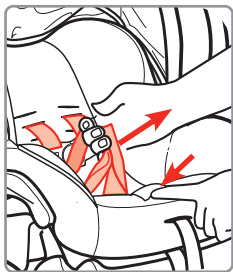

- Push down and hold on the on the harness release lever (under flap - see **pg 8**).
- Pull on one harness strap or both harness straps simultaneously.
- Remove harness straps from splitter plate at rear of seat.

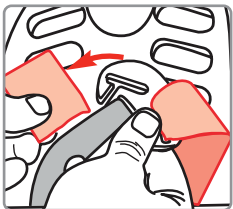

- From the front, pull harness straps out of the shell and trim. Remove the shoulder pads and insert.

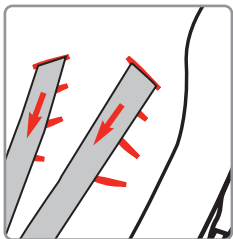

### **VERY IMPORTANT:**

**Only replace the cover with a manufacturer's supplied replacement cover with identical shoulder height markers or a replacement cover meeting AS/NZ 8005.**

## Care and cleaning

Remove seat cover for cleaning

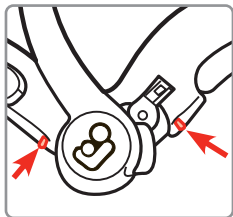

- To release the tab, pull down on the pad and pull the tab out of the child restraint.

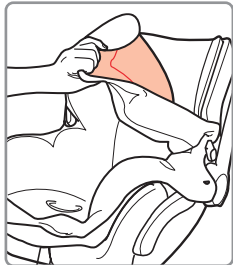

- From the top, pull the trim off the seat. After cleaning the trim, replace by reversing order.
- To release the tab, pull down on the pad and pull the tab out of the child restraint.

## Care and cleaning

### Cleaning buckle

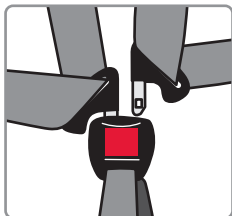

- Push **red** button to release the buckle.
- From under seat shell, turn and slide buckle's metal retainer up through the shell and trim, removing the buckle.

**NOTE:** For cleaning instructions, see page 48.

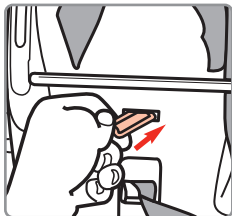

- To assemble, ensure that the **red** button on the buckle is facing out. Push metal clip through trim and shell.

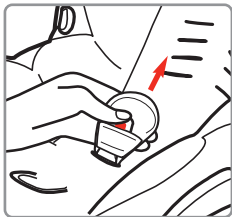

- From other side, pull on buckle to check to make sure buckle's metal retainer is correctly inserted through the trim and shell.



## Care and cleaning

### Cleaning buckle

Follow the manufacturer's instructions at all times. Before removal, ensure you have carefully noted the way which the various parts are attached to the seat so as to facilitate reassembly.

Your child restraint is equipped with a buckle designed to give your child maximum protection during proper use. When working properly, your buckle should always fasten with an audible **click**.

If sticky liquids (such as baby food, fruit juice, etc.) get into the buckle it may become sluggish and you may not hear a **click**.

The buckle should be cleaned by following the steps below.

#### **CLEANING BUCKLES**

- Place the buckle unit under running water (40 degrees Celsius). Let the water flow through the mouth of the buckle for one minute.
- Immediately latch and unlatch the tongues into the buckle several times until a strong audible click is heard.
- **Do not** oil any part of the buckle.
- Allow buckle to dry.
- If the buckle does not work, contact Dorel Australia Customer Service on 1300 809 526

## Care and cleaning

### General maintenance

- All other surface should be cleaned with a mild soap and water.
- Never clean with ammonia or bleach based, or spirit-type cleaners.
- Clean the frame with a damp cloth.
- Do not use the restraint without the cover.
- Check the webbing for fraying.
- Ensure there are no cracks in moulding or the plastic moulding.
- Check the Harness Adjuster is operating and is clamping the webbing.
- If any part of the restraint is cracked or broken, seek repair immediately or replace the child restraint.

## The next seat for your child

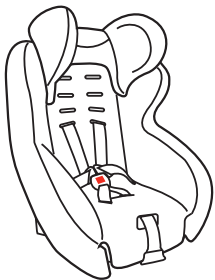

### OPTION 1: TYPE A1 AND B CONVERTIBLE CAR SEAT

To be used only in a rearward-facing position until the infant's shoulders reach the lower shoulder height marker (approximately **6 months** of age). Then to be used in a forward-facing position until the child's shoulders reach the upper shoulder height marker (approximately 4 years of age).

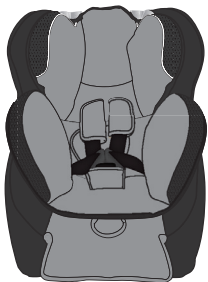

### OPTION 2: TYPE A2 AND B CONVERTIBLE CAR SEAT

To be used only in a rearward-facing position until the infant's shoulders reach the lower shoulder height marker (approximately **12 months** of age). Then to be used in a forward-facing position until the child's shoulders reach the upper shoulder height marker (approximately 4 years of age).

## Notes

---

---

---

---

---

---

---

---

---

---

---

---

---

---

---

## Notes

---

---

---

---

---

---

---

---

---

---

---

---

---

---

---

---

---

## Notes

---

---

---

---

---

---

---

---

---

---

---

---

## GUARANTEE

Dorel Australia Pty Ltd warrants your new product to be free from defects in materials and workmanship for 6 years on the seat & 3 years on the trim, from the date of purchase, provided that the product is used in accordance with accompanying recommendations or instructions where provided. The benefit of this warranty is in addition to your rights under the Australian Consumer Law and to other rights and remedies of the consumer under a law in relation to the goods or services to which the warranty relates.

Dorel Australia Pty Ltd will provide you with your choice of a refund, repair, or exchange (where possible) for this product if it becomes defective within the warranty period. Dorel Australia Pty Ltd will bear the reasonable expense of claiming the warranty. This warranty will no longer apply where the defect is a result of alteration, accident, misuse, abuse, or neglect.

Please retain your receipt as proof of purchase and contact our Customer Service team on Ph: **1300 809 526** or alternatively, via our website at **www.dorel.com.au** for any difficulties with your product. Warranty claims and claims for expense incurred in returning this product can be addressed to our Consumer Service team at **655-685 Somerville Road, Sunshine West, VIC, 3020**. Hours: 8:30 am to 5:00 pm, Monday to Friday.

For New Zealand please contact Customer Service Centre, **14 Sir William Avenue, East Tamaki, Auckland, 2013**. Auckland: **(09) 2741040** NZ wide: **0800 628 000** (Toll Free). Hours: 8:00 am - 5:00 pm, Monday to Friday.

Our goods come with guarantees that cannot be excluded under the Australian Consumer Law. You are entitled to a replacement or refund for a major failure and compensation for any other reasonably foreseeable loss or damage. You are also entitled to have the goods repaired or replaced if the goods fail to be of acceptable quality and the failure does not amount to a major failure.

**IMPORTANT: KEEP THIS INSTRUCTION MANUAL  
IN THE POCKET PROVIDED ON THE HEADREST.**



Australian  
Standard  
AS/NZS 1754 Lic 1491  
SAI Global



# MAXI-COSI®

The Original European Brand  
Synonymous with Safety, Quality & Style

© 2014 Dorel Australia, Pty Ltd. All Rights Reserved.  
MAP 2013, 2013L #015017 06/14

