

Cewe Digital Programmable Transducer User Manual

Ver. 1.2



Contents

Introduction	4
About this user manual.....	4
Contacting us.....	4
Product Description	5
Connections.....	5
Mechanical design.....	7
Measuring principles.....	8
Block diagram.....	9
Configuration, reading and maintenance	10
Connecting to the transducer.....	11
Basic configuration.....	13
Overview of functions.....	15
Changing configuration.....	16
Working with configurations.....	16
Reading.....	17
Information about the transducer.....	17
Versions and version conflicts.....	18
Upload new firmware.....	18
Language.....	19
Resetting MD values.....	19
Functions	20
Analogue outputs.....	20
Digital outputs.....	23
Instant values.....	24
Remote control.....	25
Communications and security.....	26
Average and Maximum Demand.....	27
Miscellaneous.....	28
Measured Quantities	29
Modbus Map.....	37
Introduction.....	37
General concepts.....	37
Configuration registers.....	39
Data registers.....	40
Appendix A – Declaration of Conformity	45
Appendix B – Network System Connection Diagrams	47
Appendix C - Measured Quantity Definitions.....	55
Appendix D – Material Declaration	59
Appendix E - Applicable standards and regulations	60
Appendix F – Approvals and certificates.....	61
Appendix G – Technical specification	62

Introduction

Introduction

Thank you for choosing the Cewe digital programmable transducer, from here on described as Cewe DPT

The Cewe DPT is a complete 3 phase programmable multifunction transducer in a 104 mm DIN rail mounting case. It provides very high accuracy in all measured quantities and can also provide measured instantaneous quantities on a bus system, for instance voltage, power, frequency. The Cewe DPT extensive configurable functional features together with the high accuracy enable application areas more numerous than for traditional transducers. Besides having well-designed traditional features such as current and voltage outputs it also communicates via two communication ports and can measure power quality quantities.

About this user manual

This user manual describes the Cewe DPT's functions and provides the information needed to configure and use the transducer. The manual covers all versions of the dCewe DPT. Some of the described functional properties can be missing in certain transducer versions. The Cewe DPT is complemented with ConfigView, a PC program for configuring, manual reading and maintenance. The ConfigView is a part of the Cewe Instrument Management Console program.

Contacting us

For more information and technical support, please contact Cewe Instrument.

Internet	www.ceweinstrument.se
E-mail technical support	support@ceweinstrument.se
E-mail order and product information	marknad@ceweinstrument.se
Telephone	+46 (0)155 77500
Address	Cewe Instrument AB Box 1006 SE-611 29 Nyköping

Product Description

Product Description

Connections

Connections to the Cewe DPT are made on the meter terminal on the front of the transducer. The connections are: measuring voltages, measuring currents, analogue outputs, relay outputs, separate auxiliary power and connections to communication modules.

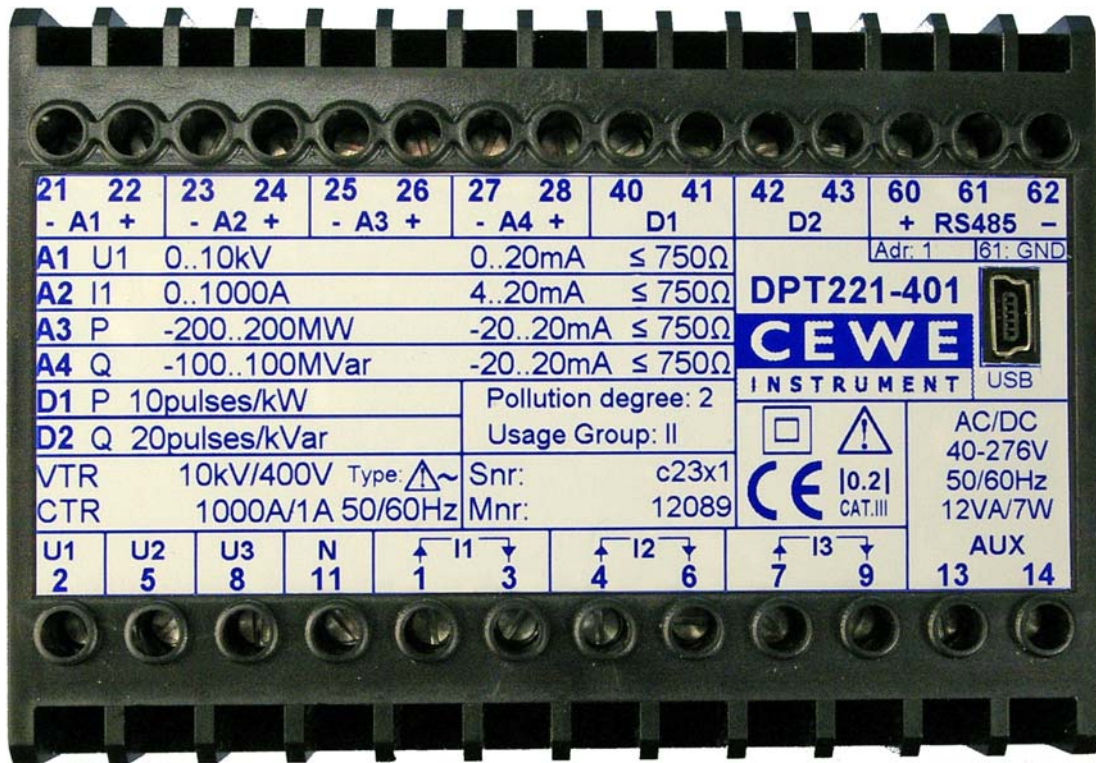

Connections for Cewe DPT

Analogue outputs

Channel	Designation	Number	- / +
Ch 1	A1	21	-
		22	+
Ch 2	A2	23	-
		24	+
Ch 3	A3	25	-
		26	+
Ch 4	A4	27	-
		28	+

Digital outputs

Ch 1	D1	40,41
Ch 2	D2	42,43

Connections

U1	2	I1	1	OU T	3
U2	5	I2	4		6
U3	8	I3	7		9
N	11				
U _{aux1}	13				
U _{aux2}	14				

Current, voltage and auxiliary power connections for Cewe DPT.

RS-485 communication

+	60
GND	61
-	62

Product Description

Connector for Cewe DPT

The screw terminals in the Cewe DPT are equipped with wire guards and can be used with cables up to 6 mm².

Auxiliary power

The **Cewe DPT** is supplied with separate auxiliary power input. Auxiliary power can be supplied both with alternating current (AC) and polarity-independent direct current (DC) within a specified range and frequency. The power supply covers the whole range in the same variant.

Digital outputs

The Cewe DPT digital outputs are solid-state MOS-FET bipolar semiconductor relays, with normally open contact function. Internal current limit protects the relay from being damaged by excessively high current. They are galvanically isolated from all other terminals.

Analogue outputs

The Cewe DPT analogue outputs can either be hardware configured as bi-polar directional current or voltage outputs. They are open- or short-circuit protected and galvanic isolated from all other terminals.

Communication ports (RS485 and USB)

The Cewe DPT is equipped with two serial communication ports, USB and RS485. It is possible to use both ports simultaneously.

- The USB point-to point connection is used for both configuration and reading of the Cewe DPT through a standard USB Mini-B connector. Modbus RTU is used as protocol.
- The RS485 multi-drop connection is used for both configuration and reading of the Cewe DPT through three screw terminals used for shielded twisted-pair wires. Modbus RTU is used as protocol.
It is possible to block the configuration option over RS485 and only allow reading.

Product Description

Mechanical design

The Cewe DPT can be mounted on any DIN-rail top hat rail system in any direction, according to DIN EN 50022.

Dimensions (WxHxD): 104 x 71 x 114 mm

Enclosure and protective earth

The enclosure consists of a transducer base and a cover. The transducer is not connected to protective earth.

Isolation and personal safety

The current inputs are galvanically isolated from each other and to any other internal or external potential.

The voltage input group is galvanically isolated to any other internal or external potential. The analogue and digital outputs and COM-ports are isolated from each other and to any other internal or external potential.

Product Description

Measuring principles

The measuring circuit in Cewe DPT consists of current and voltage transformers that provide signals to six parallel AD converters (analogue to digital converters) that are synchronised by a common clock signal. The digital signals are thereafter processed by a DSP. Using voltage transformers makes the electronics in the meter galvanically isolated from the measurement voltage, which provides good personal safety and protection for connected equipment, such as analogue outputs and communication equipment.

Calculation flow

All values are calculated in the Cewe DPT based on calibrated current and voltage values. Current and voltage amplitudes and phase angles are fully compensated in regards to accuracy, harmonics, frequency and temperature at all times. Based on these individually compensated current and voltage signals, all quantities that the Cewe DPT can present, are subsequently calculated. This means that accuracy for instant values is excellent and that active and reactive power are correctly calculated, including harmonic power.

3-element transducer

On the 3-element Cewe DPT, the phase voltages and neutral wires are connected to the transducer. The voltages measured are phase voltages. Power is calculated from three phase voltages and three currents. Harmonic measurement is made on phase voltages. The phase to phase voltage is calculated from the phase voltages. The different possible connection ways (No 1 and 2) can be seen in Appendix B – Network System Connection Diagrams (pg. 47).

2-element transducer

On the 2-element Cewe DPT, the neutral conductor is not connected to the transducer. The voltages measured are subsequently phase to phase voltages. Power is calculated based on two phase to phase voltages (U12 and U31) and two currents (I1 and I3) according to the 2-watt meter method. The 2-element meter is primarily used for D-connected systems (3-wire). Harmonic measurement is made on phase to phase voltages. The different possible connection ways (No 3 to 7) can be seen in Appendix B – Network System Connection Diagrams (pg. 47).

1-element transducer

On the 1-element Cewe DPT, the single phase voltage and neutral wires are connected to the transducer. The voltage measured is phase voltages. Power is calculated from the single phase voltage and current. Harmonic measurement is made on phase voltage. The phase to phase voltage is calculated from the phase voltage. The different possible connection ways (No 8) can be seen in Appendix B – Network System Connection Diagrams (pg. 47).

A transducer that is bought with a certain element configuration can be changed to any other element configuration by the user.

Product Description

Block diagram

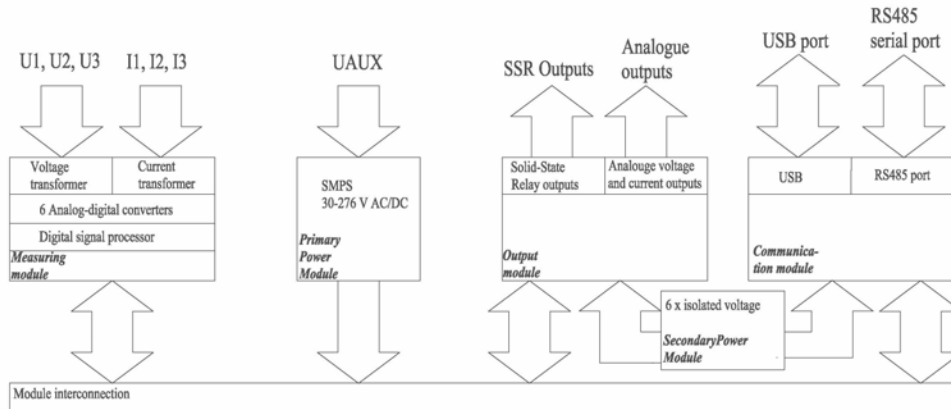

Configuration, reading and maintenance

Configuration, reading and maintenance

ConfigView is a PC program that makes all Cewe DPT functions available. With ConfigView, you can do:

- **Configuration**
Configuring means that parameters affecting transducer function can be set. Examples of parameters that can be configured are: transformer ratios, curves for analogue outputs and baudrates.
- **Reading**
The information that can be read is instant and output values.
- **Remote control**
The **Cewe DPT** can be used to set both the analogue and digital outputs to a certain value without having any input signals.
- **Maintenance**
Examples of maintenance tasks are: resetting the Maximum Demand (MD) values and updating the firmware in the meter.

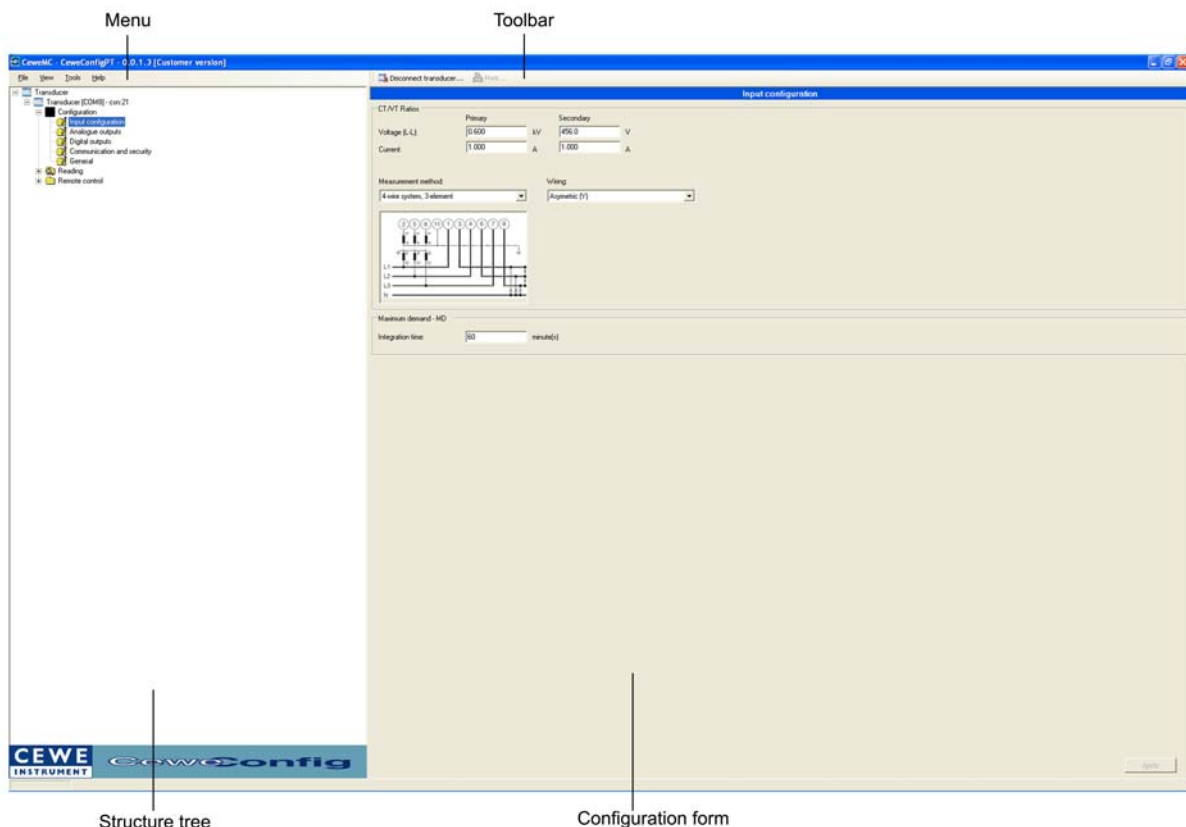

Configuration, reading and maintenance

Connecting to the transducer

To be able to configure or read values in the Cewe DPT, ConfigView must be connected and have authorisation to access the transducer. The transducer has a password that can be set. See the section Communications and security (pg. 26). With the transducer's usual factory settings, no password is configured, and subsequently no password is necessary when connecting. If the transducer has a password it is still possible to read the settings in the transducer.

To communicate with the transducer, the PC must be physically connected to the Cewe DPT in one of the following ways:

- PC – USB cable – Transducer
- PC – Straight serial cable – RS485 converter – Daisy chained transducers

Note: Auxiliary supply needs to be connected to the Cewe DPT to be able to communicate with the transducer.

A first ever computer USB connect to the transducer

This chapter is only necessary to do once for every computer, regardless of how many transducers are connected to the same computer.

To be able to communicate via the USB port it is necessary to install the drivers for the USB port as a virtual COM-port.

1. Ensure that the transducer has auxiliary power.
2. Connect the USB mini-B type cable between the transducer and the computer.
3. An installation shall start automatically and show a similar window as below.



4. Select the automatic choice and the driver will be downloaded from the transducer. If not, the software driver can be found on the installation media together with the installation package for ConfigView.
5. When everything is ready, click OK to finish the installation.
6. The virtual COM-port that is assigned will be auto detected by ConfigView. To identify the virtual COM-port manually it can be found by opening the Control Panel, System/Hardware/Device Manager and expand the Com port node.

Configuration, reading and maintenance

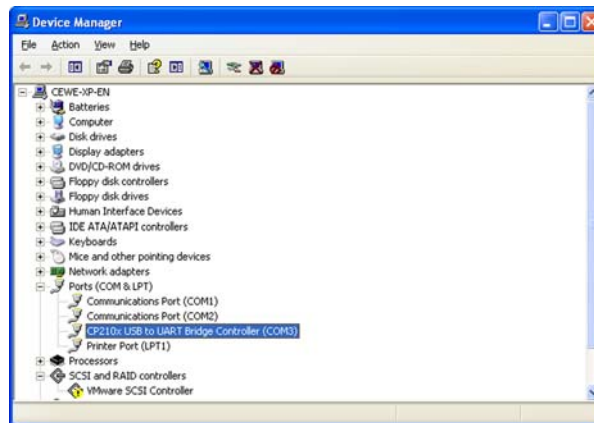

7. Continue to “Usual connection to the transducer”.

Usual connection to the transducer

To prepare ConfigView for configuration of a transducer, a connection must be established between ConfigView and the transducer. To open a connection, execute the following steps:

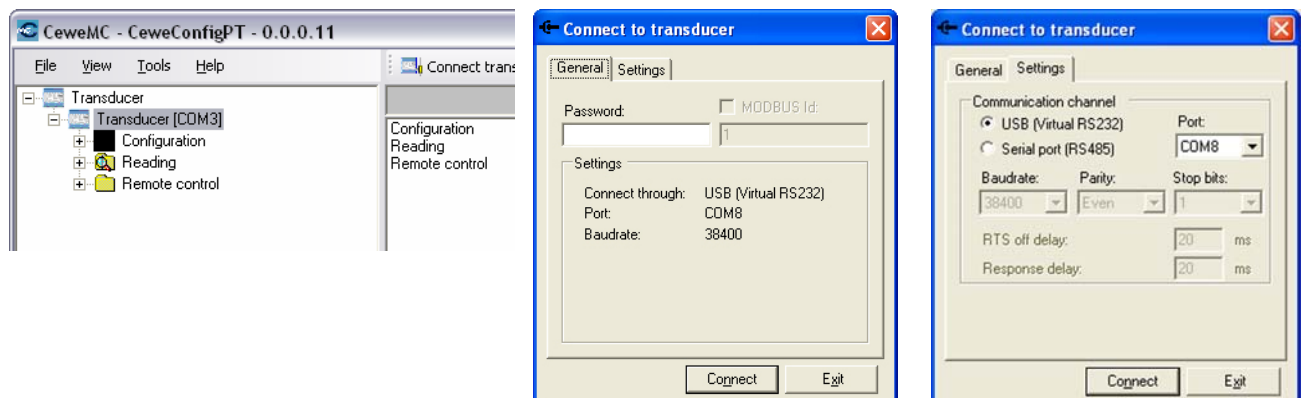

How to connect to the transducer

1. Select the transducer to connect

Select a transducer connection by clicking in the left hand tree panel. If there is no transducer added start by right click on the top level and add a transducer.

2. Connect to the transducer

Choose **Connect transducer** from the **File** menu or by clicking the toolbar button.

Configuration, reading and maintenance

3. Communication channel

Click the **Settings** tab and choose either, **USB (Virtual RS232)** or **Serial Port (RS485)**. If the serial port is used, the baud rate and parity must be selected. For transducers with factory settings, the baud rate is 9600.

Note: The selectable communication ports are taken from Windows and show every port that is assigned to this type of transducer.

4. Response delay

It is possible to set the response delay of ConfigView. This can be changed if there is a problem with the connection and it is suspected that the PC system isn't fast enough. It is also possible to set the RTS delay from the PC so that the last bit(s) of the message isn't cut.

5. Password

Click the **Common** tab. If required a password is entered if one is configured in the transducer. With the transducer's factory settings, no password is configured, and subsequently no password is necessary when you connect.

6. MODBUS Id

MODBUS Id is the identification of a transducer on a multi-drop RS485 line. This number is only required if a special transducer is to be addressed when several meters are connected together with RS485.

7. Click the **Connect** button.

Problems with connecting

If the meter cannot be connected, an error message is displayed. Depending on the reason, the message can suggest corrective actions, such as changing the port or port baud rate.

Basic configuration

Some basic settings may be required before the Cewe DPT will be able to measure and operate correctly in a system.

Note: Settings are only necessary if they have not been made at the factory prior to delivery.

To change the configuration for a transducer, you must be connected to it. Click the **Configuration** folder in the structure tree to the left in ConfigView to display the various functions that can be configured. For more information see the section Changing configuration (pg. 16).

Tip: You can save a configuration from a transducer to a file. A summary of the configuration can also be printed out. You can also create a configuration without being connected to a transducer. For more information, see Working with configurations (pg. 16).

Configuration, reading and maintenance

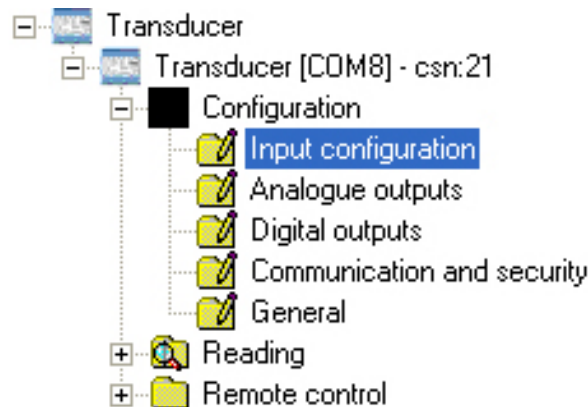

- Transformer ratios:** For the transducer to measure accurately, the ratios for current and voltage transformers must be correct. To configure the transformer ratio in ConfigView, choose the node **Transducer – Configuration – Input configuration** in the structure tree. Fill in the primary and secondary values for current and voltage. Lowest possible voltage and current is 1V respective 0.01A. The ratio between primary and secondary can lowest be 0.1.

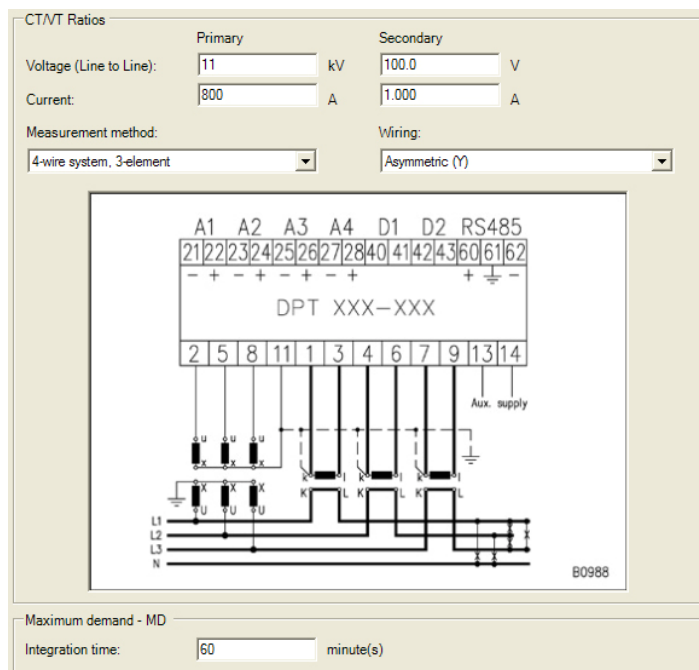

Note: The values you choose as primary and secondary values will be considered as the nominal values.

- Measurement method:** It is possible to set the correct measurement method with two drop down toolbars. A picture will also display the proper way to install the transducer. All possible measurement variants are shown in Measuring principles (pg. 8).
- Analogue output curves:** To configure the analogue output curves in ConfigView, choose the node **Transducer – Configuration – Analogue outputs** in the structure tree. Find out how **Analogue outputs** works and how it can be configured in the section Analogue outputs (pg. 20).

Configuration, reading and maintenance

- **Pulse constants for pulse outputs:** To configure pulse constants for digital pulse outputs in ConfigView, choose the node **Transducer – Configuration – Digital outputs** in the structure tree. Find out how **Digital outputs** works and how it can be configured in the section Digital outputs (pg. 23).

Overview of functions

The following is a brief overview of the functions available in Cewe DPT. All functions in the transducer can be both configured and read in ConfigView. In many cases, ConfigView can also export data to a file or print out data.

Function	Configuration location in ConfigView	Section in handbook describing the function.
Analogue outputs Set the functions for the up to four analogue outputs.	Transducer – Configuration – Analogue outputs	Analogue outputs (pg. 20)
Digital outputs Set the functions for the up to two digital outputs.	Transducer – Configuration – Digital outputs	Digital outputs (pg. 23)
Instant values Presentation of instant values like voltage and current.	Transducer – Reading – Instant values	Instant values (pg. 24)
Remote control Control the analogue and digital outputs regardless of the input	Transducer – Remote control – Remote control of analogue outputs and Remote control of digital outputs	Remote control (pg. 25)
Password A correct password will allow changing of configuration in a password protected transducer.	Transducer – Tools – Change Password.	Communications and security (pg. 26)
Communication speed Set the baud rate for the transducer's serial ports.	Transducer – Configuration – Communication and security	Communications and security (pg. 26)
Maximum demand Determine values that are to be stored as maximum average values.	Transducer – Configuration – Input configuration	Average and Maximum Demand (pg. 27)
Information texts Enter information text that can be implemented in configuration summary.	Transducer – Configuration – General	Miscellaneous (pg. 28)
Customer serial number A possibility to add a customer unique serial number	Transducer – Configuration – General	Miscellaneous (pg. 28)

Configuration, reading and maintenance

Changing configuration



To open a configuration form, click the folder **Configuration** in the structure tree and then click one of the nodes: **Input configuration**, **Analogue outputs** etc. Configuration changes can be made in all configuration forms. In the lower right corner, there is an **Apply** button. If a transducer is connected and you click **Apply**, changes to the configuration will be immediately transferred to the transducer.

Working with configurations

In ConfigView, you can work with configurations as a collection of the Cewe DPT's settings and save them in a file. On ConfigView's **File** menu, are the commands **Save configuration** and **Open configuration**. On the **View** menu, there is a command for creating a configuration summary. Below is a list of how you can use ConfigView's functions to work with configurations.

- **Creating a configuration file without being connected to a transducer**
Any changes to the configuration can be applied and then saved as a configuration. Make all settings that are to be included in the configuration file and save the file. The file's configuration can later be transferred to a transducer.
- **Saving a transducer's configuration to a file**
Choose **Save configuration** when ConfigView is connected to a transducer to save the transducer's configuration to a file. The configuration file can later be used as a backup or be transferred to another transducer.
- **Transferring a configuration file to a meter**
Choose **Open configuration** when ConfigView is connected to a transducer to transfer a configuration file.
- **Printing out a summary of a transducer's configuration**
Choose **View– Configuration summary** when ConfigView is connected to a transducer to create a summary of the transducer's entire configuration. Now choose **Print**.
- **Printing out a summary of a configuration file**
Open a configuration file and choose **View – Configuration summary** to create a summary of the configuration that is in the file. Together with a **Print** option there is also options for export to either Excel- or pdf-file.

*Note: Choosing **Open configuration** when ConfigView is connected to a transducer opens a warning dialog box with the message that the configuration in the transducer will be written over if you continue.*

Note: A configuration that is done offline must be saved before connecting to the transducer. Otherwise it will be overwritten by the configuration in the transducer.

Configuration, reading and maintenance

Reading

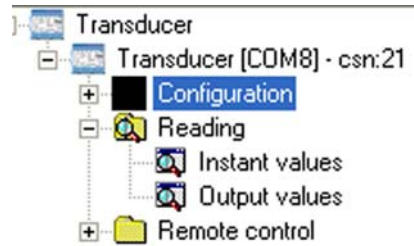

If you are connected to a Cewe DPT two alternatives will be available in the structure tree under the node **Reading**. The displayed values are constantly updated. Read values can be printed out as a snapshot of the time when the print command was issued. It is also possible to save as a snapshot or do a continuously saving of data every second. A pop-up dialog will ask where the data should be saved in the system.

Information about the transducer

General	
Serial number	21
Application	0.2.7
Firmware branch	1
OTP version	7
Port	USB
Modbus version	1
Output configuration (hardware)	
Output A1	-20mA .. 20mA
Output A2	-20mA .. 20mA
Output A3	-20mA .. 20mA
Output A4	-20mA .. 20mA

Information about the connected transducer can be obtained by choosing **View – Information about the transducer**. This information is vital when contacting support if you encounter problems with the transducer.

Configuration, reading and maintenance

Versions and version conflicts

The latest version of ConfigView can be used with all firmware (application) versions of Cewe DPT. The version number for ConfigView is displayed on the application's title bar or under **About ConfigViewPT** on the **Help** menu. The version number for the transducer's firmware can be viewed under **Information about the transducer** on the **View** menu.

Cewe DPT and ConfigView have three-digit version numbers according to the format *main version.sub-version.build number*. As long as the main version and sub-version are the same, ConfigView and the transducer are compatible. If the transducer firmware is of a newer version than ConfigView and the main version and/or sub-version are different, ConfigView will display a message that connection is not possible. ConfigView must be updated.

Upload new firmware

Cewe DPT is designed to be able to receive updated firmware via the serial ports. Newly developed and improved functions can thus be added in a transducer that lacked these functions when delivered.

Note 1: Be sure to upgrade ConfigView to the latest version before upgrading the transducer. There is otherwise the risk that ConfigView will no longer be version-compliant after firmware upload.

Note 2: The USB serial port shall be used when uploading new firmware unless it is absolutely necessary to use RS485. If RS485 is used when uploading Modbus is not used.

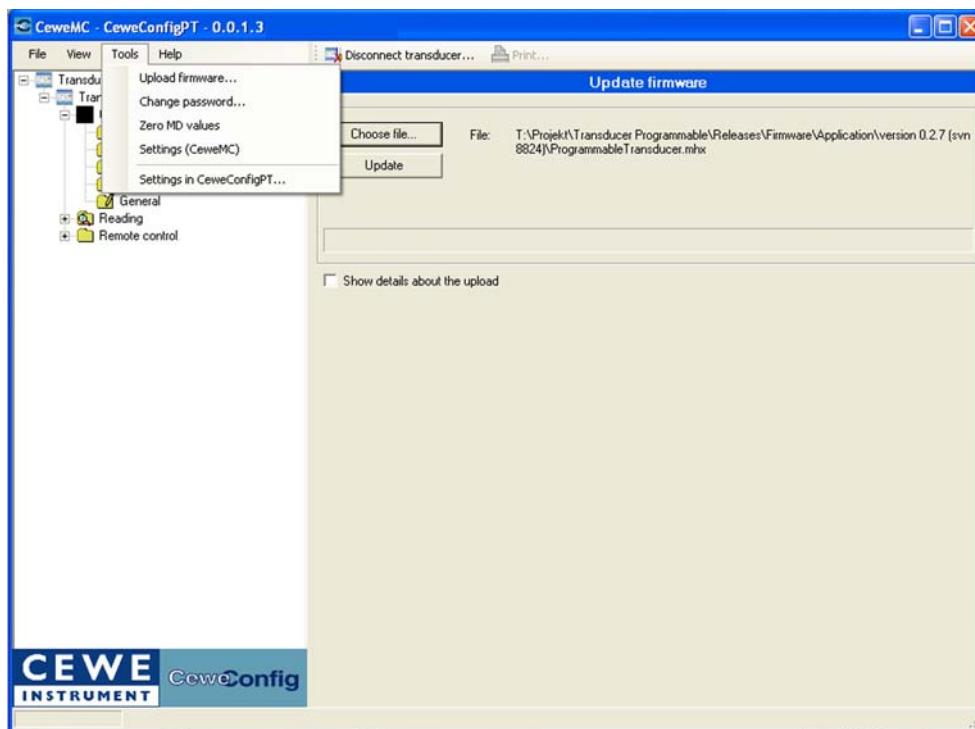

Configuration, reading and maintenance

On the **Tools** menu, there is an **Upload firmware** command when the transducer is connected with the correct password or when no password is set. Begin by choosing the file that contains the update. The file name and version number will then be displayed, and sometimes a message. Check the box **Show details about the upload** to view more information about the upload. Click **Update** to begin updating.

During the time the update is being installed, the transducer stops measuring. Depending on the size of the file to be transferred and the baud rate, the time for updating will vary. If possible, connect at the highest baud rate (38400 bps) to speed updating. After updating, the transducer is restarted automatically to complete installation of the transducer's new firmware.

Language

ConfigView can be set to different languages. The available languages can be seen under **Language** on the **View** menu.

Resetting MD values

The Maximum Demand values in the Cewe DPT can be set to zero with **Zero MD values** on the **Tools** menu.

Both average demand and MD values will be set to zero when the auxiliary is lost.

Functions

Functions

Analogue outputs

The Cewe DPT has up to four analogue outputs that can be configured to either remote control or to output a current or voltage signal that reflects to any of the measured quantities. They have an isolated interface between the electronics and the surroundings to ensure personal safety. For electrical data on the transducer's outputs, see **Appendix G – Technical specification** (pg. 62).

Outputs

The outputs can be configured as follows:

- **Inactive**
The output is not used. The output will be set to 0 mA or 0V, depending on the configuration.
- **Remote control**
With this function, the output can be made active without having any input signals to the transducer. For more information, see Remote control (pg. 25)
- **Measurand quantity**
This defines which of the quantities measured by the transducer will be reflected on the output. Most of the quantities also need to be selected for a phase or the complete system. The unit for the selected measurand is shown to the right of the two drop down lists.

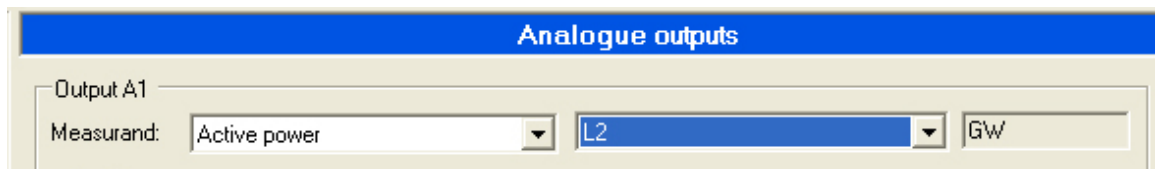

Quantity	By phase	Total	Unit
Active power	Yes	Yes	W
Reactive power	Yes	Yes	var
Apparent power	Yes	Yes	VA
Active power factor P/S	Yes	Yes	
Reactive power factor Q/S	Yes	Yes	
LF factor $\text{SgnQ}(1 - \text{PF})$	Yes	Yes	
Frequency	Not applicable	Yes	Hz
Current	Yes	Yes	A
Phase voltage	Yes	Yes	V
Phase to phase voltage	Yes	Yes	V
Current with sign	Yes	Yes	A
Phase angle	Yes	Yes	rad
Phase angle voltage (phase to neutral)	Yes	Not applicable	rad
Phase angle voltage (ph-ph)	Yes	Not applicable	rad
Phase angle current	Yes	Not applicable	rad
THD current	Yes	Not applicable	%
THD voltage	Yes	Not applicable	%
Average current	Yes	Yes	A
MD current	Yes	Yes	A
Average active power	Yes	Yes	W
MD active power import	Yes	Yes	W
MD active power export	Yes	Yes	W
Average reactive power	Yes	Yes	var
MD reactive power import	Yes	Yes	var
MD reactive power export	Yes	Yes	Var
Average apparent power	Yes	Yes	VA
MD apparent power	Yes	Yes	VA

Breakpoints

There must always be two end points to define the max and min values of the output. Up to seven additional breakpoints can be defined between the end points. Each end point and breakpoint is a pair of numbers mapping the measured unit (for instance Watt for active power) to the output unit (for instance A for a current output). Note that the hardware configuration of the output is shown in brackets in this area (for example [-20mA .. 20mA]). There is a 10% over range on the defined hardware configuration. It is always possible to change or delete all added breakpoints.

Accuracy

The accuracy of each of the analogue outputs at full value is in worst case an additional 0,05% over the bus value, see Bus accuracy (pg. 24). At lower values the error will increase. It is recommended not to use an analogue output in a low range that is covered by another hardware variant of the Cewe DPT. For instance a -20mA .. 20mA hardware should not be used as a -5mA – 5mA output as there is a separate hardware for this range.

Functions

Response time

Response time can be used to filter the changes in output. It defaults to 300ms and is programmable between 200 ms to 60 seconds.

Digital outputs

The Cewe DPT has two digital outputs that can be configured to perform various tasks. They are protected against overvoltages by varistors. They also have an isolated interface between the electronics and the surroundings to ensure personal safety. For electrical data on the transducer's outputs, see **Appendix G – Technical** specification (pg. 62).

Outputs

The outputs can be configured as follows:

- **Not used**
The output is not used. It is set to open condition.
- **Pulse output**
The output is used to pulse a energy type that the transducer is measuring. A pulse constant is specified for the output as primary pulses/unit as well as the pulse length. The shortest possible pulse length is 10 ms. Pulses are not allowed to come too often, and because of this, there is a relationship between the pulse length and the specified pulse constant that maximises the pulse frequency to $1000/(\text{pulse length}(\text{ms}) * 2)$.

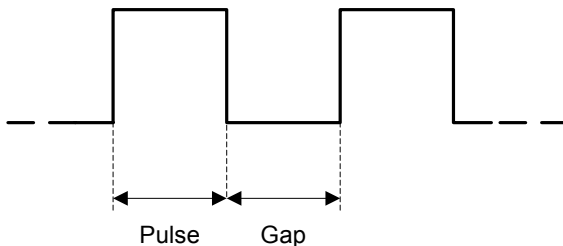

Maximum pulse frequency at outputs is limited so that the gap is at least as long as the pulse length.

The pulse outputs can be inverted. Note that outputs are inverted via firmware. If the meter loses its auxiliary power, the relay will open, regardless if it is inverted or not.

- **Remote control**
With this function, the output can be made to switch between open and closed without having any input signals to the transducer. For more information, see Remote control (pg. 25)

Accuracy of the pulse output

The accuracy of each of the digital outputs is $\pm 0,30\%$ of full scale value for all connections except when the neutral (N) is not connected, see system No 3 in Appendix B – Network System Connection Diagrams (pg. 47).

To achieve this accuracy the minimum measured period is 30 seconds.

The outputs comply with 0.5s accuracy.

Functions

Instant values

Besides being a transducer, the Cewe DPT can also measure and present instant values. Instant values are constantly changing values such as current, voltage, power and harmonics.

Overview

The table in Measured Quantities (pg. 29) provides an overview of the instant values that can be read with the transducer. Readings can be viewed with ConfigView or with other software that has implemented Cewe DPT's communication protocol.

Update frequency

The update frequency for instant values is proportional to the frequency of the measured quantity. At 50 Hz updating occurs 12.5 times per second, and at 60 Hz, 15 times per second.

Response time for instant values on the bus

For the two serial ports it is possible to get a response time of 200 ms for all instant values as long as the communication is set to 9600 baud or higher.

Bus accuracy

The table shows the accuracy for a **Cewe DPT** with accuracy class 0.2 for a selection of instant values. The basic accuracy is valid under reference conditions acc. to IEC/EN 60688.

Instant value	Accuracy	Instant value	Accuracy
Voltage	$\pm 0,2\% \text{ FS}^1$	Frequency	$\pm 0,01 \text{ Hz}$
Current	$\pm 0,2\% \text{ FS}$	Voltage unbalance	$\pm 0,2\%$
Power	$\pm 0,2\% \text{ FS}^2$	THD Voltage and current	$\pm 0,5\%$
Power factor	$\pm 0,1^\circ$		

Additional error due to system/application configuration

Neutral N not connected, see system No 3 in Appendix B – Network System Connection Diagrams (pg. 47).

Instant value	Additional error
Voltage	0,1%
Power	0,1%
Power factor	0,1°
Phase angle	0,1°

THD

THD stands for Total Harmonics Distortion and is a measurement of the amount of harmonics present in a signal. Voltage and current THD can be read via ConfigView up to the 31st harmonic.

¹ FS: Maximum of the input configuration (Full Scale). Up to 50% of 3rd and 10% of 5th harmonics.

² FS: (FSVoltage)x(FSCurrent). Up to 50% of 3rd and 10% of 5th harmonics

Remote control

Remote control of analogue outputs

If one or more analogue output(s) has been configured as remote control the output can be set to any value within the range of the output. For example a -20 mA to 20 mA output can be set to any value with four decimals within that range.

Remote control of digital outputs

If one or more digital output(s) has been configured as remote control the output can be set to be open or closed.

Functions

Communications and security

All Cewe DPT are equipped with an USB and a RS485 port for communication. It supports USB 2.0 and MODBUS protocol. For more information on protocol support, see Modbus Map (pg. 37).

Communication speed

The transducer's USB port always runs at 38400 baud and is fully auto configured from the system.

The RS485 needs to be set to the correct baudrate to have a successful connection. The baudrate can be set between 1200 bps and 38400 bps.

The factory settings for the RS485 channel are 9600 bps, even parity and one stop bit.

It is possible to set the transducers response delay in ms. When connecting to the transducer it is also possible to set the RTS (request to send) delay in ms.

MODBUS address

A bus address can be defined for the RS485 port and it is necessary to use a unique bus address as soon as there is more than one transducer on the RS485 bus. Any number between 1 and 247 is accepted.

Password and security

The transducer has a password that will limit the access to show everything but not allowing configuration or remote control.

The password can consist of up to 40 case insensitive alpha-numerical characters.

To change the password, first enter the old and then the new password twice. The new password will be activated after a reconnect of the transducer.

The default for the transducer is to have no password.

Average and Maximum Demand

These two functions are used to output a static average value on one or more analogue outputs during the time interval set as the integration time under Configuration/Input. Both functions are calculated and presented every minute regardless of the time interval set. The average value is always presented on the analogue output. If the new average value exceeds the previously stored value for maximum demand, it becomes the new value for maximum demand.

The calculation interval can be chosen between 1 and 60 minutes in whole minutes. Before the first interval has been finished the output will be set to 0 mA or 0 V.

Average

Other name: Bimetal.

This function averages the measurand over the time interval. When the interval is finished the analogue output will change to the new value, regardless if it is higher or lower than the previous.

Possible measurands

Average current
Average active power
Average reactive power
Average apparent power

Maximum Demand (MD)

Other name: Slave pointer.

This function averages the measurand over the time interval. When the interval is finished the analogue output will change to the new value if it is higher than the previous stored value.

This value always measures the import value for the measurands and can therefore never be a negative value. Note that for active and reactive power, 'export' corresponds to the largest negative value, while 'import' corresponds to the largest positive value of the average.

Possible measurands

MD current
MD active power import
MD active power export
MD reactive power import
MD reactive power export
MD apparent power

Resetting MD

The values in the **Cewe DPT** can be set to zero with **Zero MD values** on the **Tools** menu.

Note: Average values will be reset if the transducer is disconnected from the auxiliary power, while the maximums will be retained.

Functions

Miscellaneous

Description

It is possible to type an own description with a maximum of 32 characters that will be seen in the configuration summary.

Customer serial number

There are two serial numbers in the transducer that can be used. The default serial number is set from factory and can not be changed. It is possible to set an own serial number to recognise the transducer. This serial number can be of maximum 20 characters. If such a serial number is added that is what will be shown in the tree structure in ConfigView and in configuration summary. It is possible to step back to the factory serial number by removing the customer serial number.

It is always the factory serial number that is presented in the 'Information about the transducer' menu.

Measured Quantities

Instant value	Phase	Quantity
Active power of the system $P = P1 + P2 + P3$	System	P
Active power on phase L1	L1	P1
Active power on phase L2	L2	P2
Active power on phase L3	L3	P3
Reactive power of the system $Q = Q1 + Q2 + Q3$	System	Q
Reactive power on phase L1	L1	Q1
Reactive power on phase L2	L2	Q2
Reactive power on phase L3	L3	Q3
Apparent power of the system $S=S1+S2+S3$	System	S
Apparent power on phase L1	L1	S1
Apparent power on phase L2	L2	S2
Apparent power on phase L3	L3	S3
Average power factor on all phases L1, L2, L3 $\cos\phi = P/S$	System	PF
Power factor on phase L1 ($\cos\phi$ on phase L1) $P1/S1$	L1	PF1
Power factor on phase L2 ($\cos\phi$ on phase L2) $P2/S2$	L2	PF2
Power factor on phase L3 ($\cos\phi$ on phase L3) $P3/S3$	L3	PF3
Average power factor on all phases L1, L2, L3 $\sin\phi = Q/S$	System	QF
Power factor on phase L1 ($\sin\phi$ on phase L1) $Q1/S1$	L1	QF1
Power factor on phase L2 ($\sin\phi$ on phase L2) $Q2/S2$	L2	QF2
Power factor on phase L3 ($\sin\phi$ on phase L3) $Q3/S3$	L3	QF3
$LF = \text{sgn}Q \times (1 - PF)$	System	LF
$LF = \text{sgn}Q1 \times (1 - PF1)$	L1	LF1
$LF = \text{sgn}Q2 \times (1 - PF2)$	L2	LF2
$LF = \text{sgn}Q3 \times (1 - PF3)$	L3	LF3
Frequency	System	F
Phase angle mean arctan (Q/P)	System	PA
L1 Phase angle between voltage and current (Rad)	L1	PA1
L2 Phase angle between voltage and current (Rad)	L2	PA2
L3 Phase angle between voltage and current (Rad)	L3	PA3
Phase angle phase-N voltage (Rad) Reference (usually=0)	L1	PAU1
Phase angle phase-N voltage (Rad)	L2	PAU2
Phase angle phase-N voltage (Rad)	L3	PAU3
Phase angle current (Rad)	L1	PAI1
Phase angle current (Rad)	L2	PAI2
Phase angle current (Rad)	L3	PAI3
Phase angle phase-phase voltage (Rad)	L1	PAU12
Phase angle phase-phase voltage (Rad)	L2	PAU23
Phase angle phase-phase voltage (Rad)	L3	PAU31
Average system current (Instantaneous System current) $(I1+I2+I3)/3$	System	I
L1 current	L1	I1
L2 current	L2	I2
L3 current	L3	I3
I and sign of active power (output magnitude and polarity)		
Active currents, average line currents $IS=(IS1+IS2+IS3)/3*\text{sign}P$	System	IS
Active currents	L1	IS1
Active currents	L2	IS2

Functions

Active currents	L3	IS3
System voltage average L1-L3 (Phase-N)		
Average System Voltage $U=(U1+U2+U3)/3$	System	U
L1 Phase-N voltage	L1-N	U1N
L2 Phase-N voltage	L2-N	U2N
L3 Phase-N voltage	L3-N	U3N
L1-L2 Phase-phase voltage	L1-L2	U12
L2-L3 Phase-phase voltage	L2-L3	U23
L3-L1 Phase-phase voltage	L3-L1	U31
THD L1-N voltage	L1-N	THDU1
THD L2-N voltage	L2-N	THDU2
THD L3-N voltage	L3-N1	THDU3
THD L1-L2 voltage	L1-L2	THDU12
THD L2-L3 voltage	L2-L3	THDU23
THD L3-L1 voltage	L3-L1	THDU31
THD L1 Current	L1	THDI1
THD L2 Current	L2	THDI2
THD L3 Current	L3	THDI3
Demand of system current $DI1+DI2+DI3$	System	DI
Demand of L1 current	L1	DI1
Demand of L2 current	L2	DI2
Demand of L3 current	L3	DI3
Maximum demand of system current	System	MDI
Maximum demand of L1 current	L1	MDI1
Maximum demand of L2 current	L2	MDI2
Maximum demand of L3 current	L3	MDI3
Demand of system active power $DP1+DP2+DP3$	System	DP
Demand of L1 active power	L1	DP1
Demand of L2 active power	L2	DP2
Demand of L3 active power	L3	DP3
Maximum demand of system active power import	System	MDPImp
Maximum demand of L1 active power import	L1	MDP1Imp
Maximum demand of L2 active power import	L2	MDP2Imp
Maximum demand of L3 active power import	L3	MDP3Imp
Maximum demand of system active power export	System	MDPExp
Maximum demand of L1 active power export	L1	MDP1Exp
Maximum demand of L2 active power export	L2	MDP2Exp
Maximum demand of L3 active power export	L3	MDP3Exp
Demand of system reactive power $DQ1+DQ2+DQ3$	System	DQ
Demand of L1 reactive power	L1	DQ1
Demand of L2 reactive power	L2	DQ2
Demand of L3 reactive power	L3	DQ3
Maximum demand of system reactive power import	System	MDQImp
Maximum demand of L1 reactive power import	L1	MDQ1Imp
Maximum demand of L2 reactive power import	L2	MDQ2Imp
Maximum demand of L3 reactive power import	L3	MDQ3Imp
Maximum demand of system reactive power export	System	MDQExp
Maximum demand of L1 reactive power export	L1	MDQ1Exp

Functions

Maximum demand of L2 reactive power export	L2	MDQ2Exp
Maximum demand of L3 reactive power export	L3	MDQ3Exp
Demand of system apparent power $DS1+DS2+DS3$	System	DS
Demand of L1 apparent power	L1	DS1
Demand of L2 apparent power	L2	DS2
Demand of L3 apparent power	L3	DS3
Maximum demand of system apparent power	System	MDS
Maximum demand of L1 apparent power	L1	MDS1
Maximum demand of L2 apparent power	L2	MDS2
Maximum demand of L3 apparent power	L3	MDS3

Functions

Quantities measured for each system

- x the quantity can be sent on all communication channels and be presented on analogue output.
 y the quantity can only be presented via MODBUS and USB.

Measured Quantity		4 wire asymmetric	4 wire balanced (U1-I1)	3 wire Assymmetric	3 wire Balanced Load (U12-U23-I1)	3 wire Balanced System and Load (U12-I1)	3 wire Balanced System and Load (U23-I1)	3 wire Balanced System and Load (U31-I1)	Single Phase
Active Power	P	x	x	x	x	x	x	x	
	P1	x	x						x
	P2	x	y						
	P3	x	y						
Reactive Power	Q	x	x	x	x	x	x	x	
	Q1	x	x						x
	Q2	x	y						
	Q3	x	y						
Apparent Power	S	x	x	x	x	x	x	x	
	S1	x	x						x
	S2	x	y						
	S3	x	y						
Power Factor	PF	x	x	x	x	x	x	x	
	PF1	x	x						x
	PF2	x	y						
	PF3	x	y						
Reactive Power Factor	QF	x	x	x	x	x	x	x	
	QF1	x	x						x
	QF2	x	y						
	QF3	x	y						

Functions

Measured Quantity		4 wire assymmetric	4 wire balanced (U1-I1)	3 wire Assymmetric	3 wire Balanced Load (U12-U23-I1)	3 wire Balanced System and Load (U12-I1)	3 wire Balanced System and Load (U23-I1)	3 wire Balanced System and Load (U31-I1)	Single Phase
Alt. Reactive Power Factor (sgn Q * (1 - PF1))	LF	x	x	x	x	x	x	x	
	LF1	x	x						x
	LF2	x	y						
	LF3	x	y						
Frequency	F	x	x	x	x	x	x	x	x
Current	I	x	x	x	x	x	x	x	
	I1	x	x	x	x	x	x	x	x
	I2	x	y	y	y	y	y	y	
	I3	x	y	x	y	y	y	y	
Current with sign from Active Power	IS	x	x						
	IS1	x	x						x
	IS2	x	y						
	IS3	x	y						
Voltage	U	x	x						
	U1	x	x						x
	U2	x	y						
	U3	x	y						
	U12	x	x	x	x	x	y	y	
	U23	x	x	x	x	y	x	y	
	U31	x	x	x	x	y	y	x	
Analogue Output	O1	x	x	x	x	x	x	x	x
	O2	x	x	x	x	x	x	x	x
	O3	x	x	x	x	x	x	x	x
	O4	x	x	x	x	x	x	x	x
Phase Angle U-I	PA	x	x	x	x	x	x	x	
	PA1	x	x						x
	PA2	x	y						
	PA3	x	y						

Functions

Measured Quantity		4 wire assymmetric	4 wire balanced (U1-I1)	3 wire Assymmetric	3 wire Balanced Load (U12-U23-I1)	3 wire Balanced System and Load (U12-I1)	3 wire Balanced System and Load (U23-I1)	3 wire Balanced System and Load (U31-I1)	Single Phase
Phase Angle relative U1	PAU1	x	x						x
	PAU2	x	y						
	PAU3	x	y						
	PAI1	x	x	x	x	x	x	x	x
	PAI2	x	y	y	y	y	y	y	
	PAI3	x	y	x	y	y	y	y	
	PAU12			x	x	x	y	y	
	PAU23			x	x	y	x	y	
	PAU31			x	x	y	y	x	
THD	THDU1	x	x						x
	THDU2	x	y						
	THDU3	x	y						
	THDI1	x	x	x	x	x	x	x	x
	THDI2	x	y	y	y	y	y	y	
	THDI3	x	y	x	y	y	y	y	
	THDU12			x	x	x	y	y	
	THDU23			x	x	y	x	y	
	THDU31			x	x	y	y	x	
Demand of Current	DI	x	x	x	x	x	x	x	
	DI1	x	x	x	x	x	x	x	x
	DI2	x	y	y	y	y	y	y	
	DI3	x	y	x	y	y	y	y	
Max Demand of Current	MDI	x	x	x	x	x	x	x	
	MDI1	x	x	x	x	x	x	x	x
	MDI2	x	y	y	y	y	y	y	
	MDI3	x	y	x	y	y	y	y	
Demand of Active Power	DP	x	x	x	x	x	x	x	
	DP1	x	x						x

Functions

Measured Quantity		4 wire assymmetric	4 wire balanced (U1-I1)	3 wire Assymmetric	3 wire Balanced Load (U12-U23-I1)	3 wire Balanced System and Load (U12-I1)	3 wire Balanced System and Load (U23-I1)	3 wire Balanced System and Load (U31-I1)	Single Phase
Demand of Active Power (cont'd)	DP2	x	y						
	DP3	x	y						
Max Demand of Active Power Import	MDPImp	x	x	x	x	x	x	x	
	MDP1Imp	x	x						x
	MDP2Imp	x	y						
	MDP3Imp	x	y						
Max Demand of Active Power Export	MDPExp	x	x	x	x	x	x	x	
	MDP1Exp	x	x						x
	MDP2Exp	x	y						
	MDP3Exp	x	y						
Demand of Reactive Power	DQ	x	x	x	x	x	x	x	
	DQ1	x	x						x
	DQ2	x	y						
	DQ3	x	y						
Max Demand of Reactive Power Import	MDQImp	x	x	x	x	x	x	x	
	MDQ1Imp	x	x						x
	MDQ2Imp	x	y						
	MDQ3Imp	x	y						
Max Demand of Reactive Power Export	MDQExp	x	x	x	x	x	x	x	
	MDQ1Exp	x	x						x
	MDQ2Exp	x	y						
	MDQ3Exp	x	y						
Demand of Apparent Power	DS	x	x	x	x	x	x	x	
	DS1	x	x						x
	DS2	x	y						
	DS3	x	y						
Max Demand of Apparent Power	MDS	x	x	x	x	x	x	x	

Functions

Measured Quantity									
		4 wire assymmetric	4 wire balanced (U1-I1)	3 wire Assymmetric	3 wire Balanced Load (U12-U23-I1)	3 wire Balanced System and Load (U12-I1)	3 wire Balanced System and Load (U23-I1)	3 wire Balanced System and Load (U31-I1)	Single Phase
	MDS1	x	x						x
	MDS2	x	y						
	MDS3	x	y						

Modbus Map

Introduction

Background and Scope

The Cewe DPT uses the Modbus protocol for configuration and data communication. The Modbus protocol supports reading and writing of a number of registers. The meaning of the registers is application dependent. This section specifies the meaning of the Modbus registers (the Modbus mapping) for the Cewe DPT as far as reading is concerned. If the writing registers also are interesting, please contact Cewe Instrument.

The document also defines general requirements and limitations on the communication properties of the transducer.

The transducer Modbus Map specified in this document is version 1.

References

- 1 Modbus Application Protocol Specification V1.1b
- 2 Modbus over serial line specification and implementation guide V1.02

General concepts

Modbus over serial line

The Cewe DPT implements Modbus over serial line using the RTU transport protocol according to [1] and [2].

Slave addressing

The Cewe DPT has Modbus slave address 1 as default.

Register Addressing

The transducer uses two of the possible four Modbus data blocks: Input Registers and Holding Registers. The data blocks have separate address spaces. For instance address 0003 means output type for output line 1 in the Holding Register block, but active power on L1 in the Input Register block.

Addresses in this document are given as data element address, which is Modbus PDU address + 1. To get Modbus PDU address, subtract 1 from addresses given in this document.

Serial port configuration

For the RS485 port the following attributes can be configured:

Parity (none, even or odd, default even)

Stop bits (1 or 2, 1 is default)

Baud rate (1200, 2400, 4800, 9600, 19200, 9600 is default)

Databits is always 8.

Functions

According to [2] total number of bits must always be 11, including the start bit. The transducer does however also support no parity and only one stopbit, giving a total of 10 bits, since this is common among Modbus equipment.

The USB port does not need any port specific configuration.

Security

The default configuration of the transducer allows configuration on the RS485 port. To block configuration changes on that port, set the configuration property 'Allow configuration on the RS485 port' (0x0213) to 0x0000. This can also be done in ConfigView software.

Down time during configuration

While the configuration settings are changing, after a commit, the transducer may leave its ordinary mode of operation for up to two seconds. During this period, outputs will remain as they were prior to the configuration change.

Modbus function codes

Supported function codes

The transducer supports the following Modbus function codes:

Function code	Description	Comment
3	Read Holding Registers	
4	Read Input Registers	
6	Write Single Register	
8	Diagnostics	Only allowed on RS485 if configured so.
11	Get Comm Event Counter	
12	Get Comm Event Log	
16	Write Multiple Registers	
23	Read/Write Multiple Registers	
43	Encapsulated Interface Transport/device Identification	Only supports MEI type 14, conformity 01. Will return 16 bytes with vendor name, 16 bytes product code, and 8 bytes firmware version. These will be strings padded with spaces as follows: Vendor: Cewe Instrument Product Code: DPT Version: x.y.z

Unsupported function codes

The codes listed below are defined in [1] but not supported by the transducer, and will result in ILLEGAL FUNCTION (0x01) exception code. The same is true for *any* function code not explicitly listed in the ‘supported function codes’ above.

Function code	Description	Comment
1	Read Coils	
2	Read Discrete Inputs	
5	Write Single Coil	
7	Read Exception Status	
15	Write Multiple Coils	
17	Report Slave ID	Read appropriate holding registers instead.
20	Read File Record	
21	Write File Record	
22	Mask Write Register	
24	Read FIFO Queue	
43	Encapsulated Interface Transport	Not supported except MEI type 14 as described above

Configuration registers

This section defines registers used to configure the transducer. Configuration registers are implemented as Holding Registers.

Data types

All holding registers are unsigned 16 bit big-endian integers according to the Modbus specification.

Signed 16 bit integers are represented as big-endian 2-complement.

Q values are represented as signed 16 bit integers.

ASCII fields are packed two characters per register.

32 bit integers are stored as two registers, most significant first.

Floats are stored in two registers as single precision according to IEEE 754.

Registers

When reading or writing multiple holding registers in one operation, it never allowed to span an address that is undefined. Trying to read an undefined address will cause an Illegal Data Address (02) exception response.

Functions

Holding registers

The below registers are the one that can be used for remote communication with the Cewe DPT. Note: if any holding registers shall be used with a Cewe DPT that uses password, please contact Cewe Instrument for more information.

Decimal	Property	Datatype and values
548	Customer serial number	10 addresses for customer serial number, typically interpreted as null terminated string, 2 characters per address. Must be read and written completely and alone in a single Modbus message.
777	Serial number	2 words (can be interpreted as 32 bit unsigned integer). Read only.
1297	Remote control O1	32 bit float in V or A (dep. on hardware)
1299	Remote control O2	32 bit float in V or A (dep. on hardware)
1301	Remote control O3	32 bit float in V or A (dep. on hardware)
1303	Remote control O4	32 bit float in V or A (dep. on hardware)
1312	Remote control D1/Read D1	0 or 1
1313	Remote control D2/Read D2	0 or 1

Data registers

The following data values are read only and implemented as Input Registers in the transducer Modbus map.

Calculated Values

All calculated values are represented as two consecutive Modbus registers. The value of a quantity is represented as a single precision floating point number according to IEEE 754, in SI unit.

Address (dec)	Quantity	Phase	Explanation
1	P	System	Active power of the system $P = P1 + P2 + P3$
3	P1	L1	Active power on phase L1
5	P2	L2	Active power on phase L2
7	P3	L3	Active power on phase L3
9	Q	System	Reactive power of the system $Q = Q1 + Q2 + Q3$
11	Q1	L1	Reactive power on phase L1
13	Q2	L2	Reactive power on phase L2
15	Q3	L3	Reactive power on phase L3
17	S	System	Apparent power of the system

Functions

			$S=S1+S2+S3$
19	S1	L1	Apparent power on phase L1
21	S2	L2	Apparent power on phase L2
23	S3	L3	Apparent power on phase L3
25	PF	System	Average power factor on all phases L1, L2, L3 $\cos\phi = P/S$
27	PF1	L1	Power factor on phase L1 ($\cos\phi$ on phase L1) $P1/S1$
29	PF2	L2	Power factor on phase L2 ($\cos\phi$ on phase L2) $P2/S2$
31	PF3	L3	Power factor on phase L3 ($\cos\phi$ on phase L3) $P3/S3$
33	QF	System	Average power factor on all phases L1-L3 $\sin\phi = Q/S$
35	QF1	L1	Power factor on phase L1 ($\sin\phi$ on phase L1) $Q1/S1$
37	QF2	L2	Power factor on phase L2 ($\sin\phi$ on phase L2) $Q2/S2$
39	QF3	L3	Power factor on phase L3 ($\sin\phi$ on phase L3) $Q3/S3$
41	LF	System	$LF = \text{sgn}Q \cdot (1 - PF)$
43	LF1	L1	$LF1 = \text{sgn}Q1 \cdot (1 - PF1)$
45	LF2	L2	$LF2 = \text{sgn}Q2 \cdot (1 - PF2)$
47	LF3	L3	$LF3 = \text{sgn}Q3 \cdot (1 - PF3)$
49	F	System	Frequency
51	I	System	Average System current $I = (I1 + I2 + I3) / 3$
53	I1	L1	I1 current
55	I2	L2	I2 current
57	I3	L3	I3 current
59	IS		I with sign of active power. $IS = (IS1 + IS2 + IS3) / 3 * \text{sign}P$
61	IS1	L1	$IS1 = \text{sgn}P1 \cdot I1$
63	IS2	L2	$IS2 = \text{sgn}P2 \cdot I2$
65	IS3	L3	$IS3 = \text{sgn}P3 \cdot I3$
67	U	System	Average System Voltage (Phase-N). $U = (U1 + U2 + U3) / 3$
69	U1	L1	U1 voltage (Phase-N)
71	U2	L2	U2 voltage (Phase-N)
73	U3	L3	U3 voltage (Phase-N)
75	U12	L1-L2	U12 voltage (Phase-Phase)
77	U23	L2-L3	U23 voltage (Phase-Phase)
79	U31	L3-L1	U31 voltage (Phase-Phase)
81	O1	NA	Output value 1, unit (V or A) depends on system configuration.

Functions

83	O2	NA	Output value 2, unit (V or A) depends on system configuration.
85	O3	NA	Output value 3, unit (V or A) depends on system configuration.
87	O4	NA	Output value 4, unit (V or A) depends on system configuration.
89	PA	System	Phase angle between voltage and current System means atan(Q/P)
91	PA1	L1	Phase angle between voltage and current (Rad)
93	PA2	L2	Phase angle between voltage and current (Rad)
95	PA3	L3	Phase angle between voltage and current (Rad)
97	PAU1	L1	Phase angle voltage (Rad)
99	PAU2	L2	Phase angle voltage (Rad)
101	PAU3	L3	Phase angle voltage (Rad)
103	PAI1	L1	Phase angle current (Rad)
105	PAI2	L2	Phase angle current (Rad)
107	PAI3	L3	Phase angle current (Rad)
109	PAU12	L1-L2	Phase angle voltage (Rad)
111	PAU23	L2-L3	Phase angle voltage (Rad)
113	PAU31	L3-L1	Phase angle voltage (Rad)
115	THDU1	L1	THD of U1
117	THDU2	L2	THD of U2
119	THDU3	L3	THD of U3
121	THDI1	L1	THD of I1
123	THDI2	L2	THD of I2
125	THDI3	L3	THD of I3
127	THDU12	L1-L2	THD of U12
129	THDU23	L2-L3	THD of U23
131	THDU31	L3-L1	THD of U31
133	DI	System	Demand of current $DI = DI1 + DI2 + DI3$
135	DI1	L1	Demand of current on L1
137	DI2	L2	Demand of current on L2
139	DI3	L3	Demand of current on L3
141	MDI	System	Maximum demand of current. $MDI = MD1 + MD2 + MD3$
143	MDI1	L1	Maximum demand of current on L1.
145	MDI2	L2	Maximum demand of current on L2.
147	MDI3	L3	Maximum demand of current on L3.

Functions

149	DP	System	Demand of active power. $DP = DP1 + DP2 + DP3$
151	DP1	L1	Demand of active power on L1
153	DP2	L2	Demand of active power on L2
155	DP3	L3	Demand of active power on L3
157	MDPImp	System	Maximum demand of active power.
159	MDP1Imp	L1	Maximum demand of active power on L1.
161	MDP2Imp	L2	Maximum demand of active power on L2.
163	MDP3Imp	L3	Maximum demand of active power on L3.
165	DQ	System	Demand of reactive power. $DQ = DQ1 + DQ2 + DQ3$
167	DQ1	L1	Demand of reactive power on L1
169	DQ2	L2	Demand of reactive power on L2
171	DQ3	L3	Demand of reactive power on L3
173	MDQImp	System	Maximum demand of reactive power import.
175	MDQ1Imp	L1	Maximum demand of reactive power import on L1.
177	MDQ2Imp	L2	Maximum demand of reactive power import on L2.
179	MDQ3Imp	L3	Maximum demand of reactive power import on L3.
181	DS	System	Demand of apparent power. $DS = DS1 + DS2 + DS3$
183	DS1	L1	Demand of apparent power on L1
185	DS2	L2	Demand of apparent power on L2
187	DS3	L3	Demand of apparent power on L3
189	MDS	System	Maximum demand of apparent power. $MDS = MDS1 + MDS2 + MDS3$
191	MDS1	L1	Maximum demand of apparent power on L1.
193	MDS2	L2	Maximum demand of apparent power on L2.
195	MDS3	L3	Maximum demand of apparent power on L3.
197	MDPExp	System	Maximum demand of active power export.
199	MDP1Exp	L1	Maximum demand of active power export on L1.

Functions

201	MDP2Exp	L2	Maximum demand of active power export on L2.
203	MDP3Exp	L3	Maximum demand of active power export on L3.
205	MDQExp	System	Maximum demand of reactive power export.
207	MDQ1Exp	L1	Maximum demand of reactive power export on L1.
209	MDQ2Exp	L2	Maximum demand of reactive power export on L2.
211	MDQ3Exp	L3	Maximum demand of reactive power export on L3.

Appendix A – Declaration of Conformity

CEWE INSTRUMENT	Sida (sidantal) Page (no of pages) 1 (2)		
Handläggare/Issued by LHN	Datum/Date 2010-02-16	Dokument-ID 20-0045	Utgåva/Revision 3



Manufacturers Declaration of Conformity
TILLVERKARDEKLARATION
(tillverkarens försäkran om överensstämmelse)

according to
the EU EMC-directive 2004/108/EC and
the EU Low Voltage Directive (LVD) 2006/95/EC

enligt EUs EMC-direktiv 2004/108/EG samt
EUs lågspänningsdirektiv (LVD) 2006/95/EG

Brand name or trade mark

Fabrikatnamn eller varumärke

CEWE INSTRUMENT AB

Type of equipment

Typ av apparat/utrustning

DIGITAL PROGRAMMABLE

TRANSDUCER

DIGITAL PROGRAMMERBAR

MÄTVÄRDESOMVANDLARE

Type designation etc

Typbeteckning etc

DPT (all versions)

Manufacturer or Manufacturer's authorized representative established within the EU:

Tillverkare eller Tillverkarens representant inom EU:

CEWE INSTRUMENT AB

Name, address, telephone no, telefax no.

Namn, adress, telefon, telefax

CEWE INSTRUMENT AB

BOX 1006

SE-611 29 NYKÖPING

SWEDEN

TELEPHONE + 46 155 775 00

FAX + 46 155 77597

CEWE INSTRUMENT	Dokument-ID 20-0045	Utgåva/Revision 3	Sida (sidantal) Page (no of pages)	2 (2)
---------------------------	------------------------	----------------------	---------------------------------------	-------

LVD: Reference to harmonized standard(-s) or other specification to which conformity is declared

LVD: Hänvisning till harmoniserad(-e) standard(-er) eller annan norm med vilken överensstämmelse deklarerar.

EN 61010-1:2001

EMC: Reference to harmonized standard(-s) to which conformity is declared or, if harmonized standard has not been fully applied, reference to report from competent body.

EMC: Hänvisning till harmoniserad(-e) standard(-er) med vilken överensstämmelse deklarerar eller, om harmoniserad(-e) standard(-er) inte helt tillämpats, hänvisning till intyg från behörigt organ.

EN 61000-6-2:2005

EN 61000-6-4:2007

Additional information

Övriga uppgifter

The equipment conforms with the harmonised standards or technical specifications described above, and comply with good engineering practice in safety matters in force within the EU.

Materielen överensstämmer med de harmoniserade standarder eller tekniska specifikationer som anges ovan, och uppfyller god säkerhetsteknisk praxis inom EU.

By signing this document, the undersigned declares as manufacturer, or the manufacturer's authorized representative established within the EU, that the equipment in question complies with the safety requirements stated above.

Genom att underteckna detta dokument försäkrar undertecknad såsom tillverkare, eller tillverkarens representant inom EU, att angiven materiel överensstämmer med säkerhetskraven angivna ovan.

On behalf of

För

Cewe Instrument AB

2010-02-16

Tech. manager. Teknisk chef

Date

Datum

Position

Befattning

Signature

Underskrift

Appendix B – Network System Connection Diagrams

4-wire system, 3 element asymmetric load (Y)

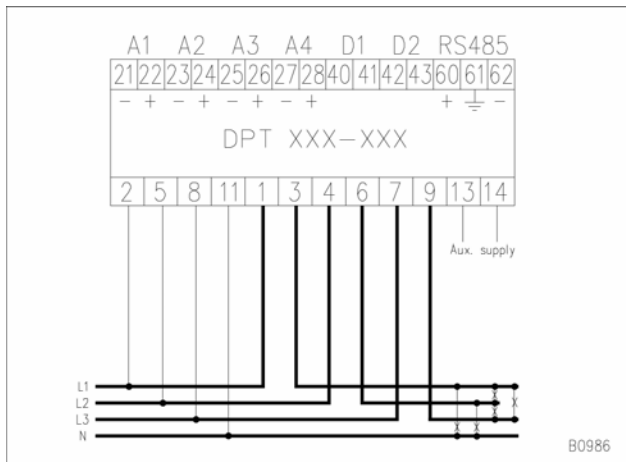

direct connected

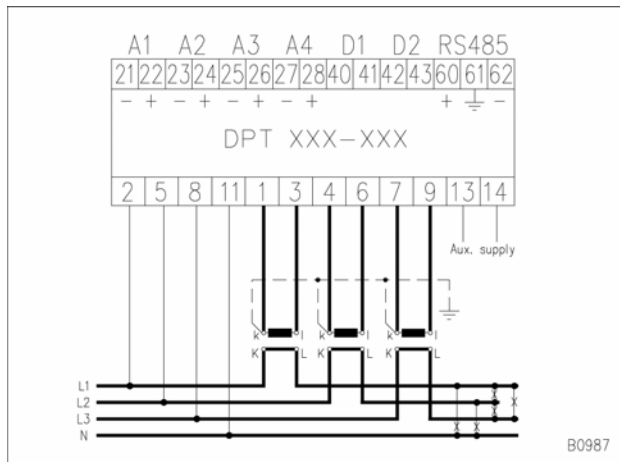

direct connected voltages and external current transformers

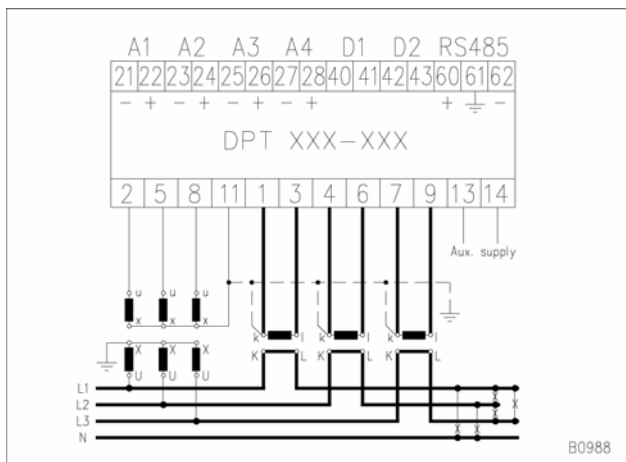

external voltage and current transformers

4-wire system, 3 element balanced load (U1-I1)

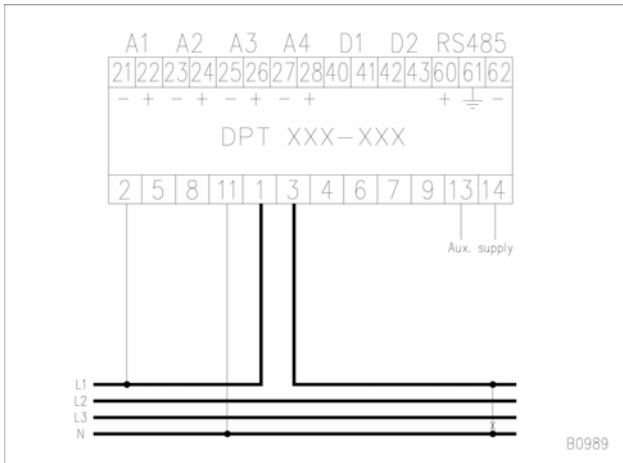

direct connected

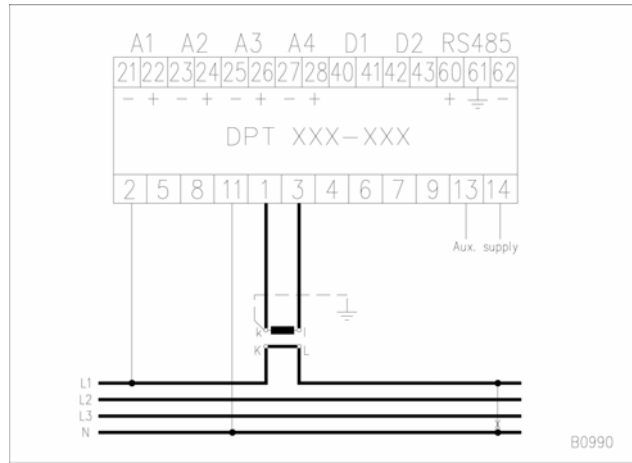

direct connected voltage and external current transformer

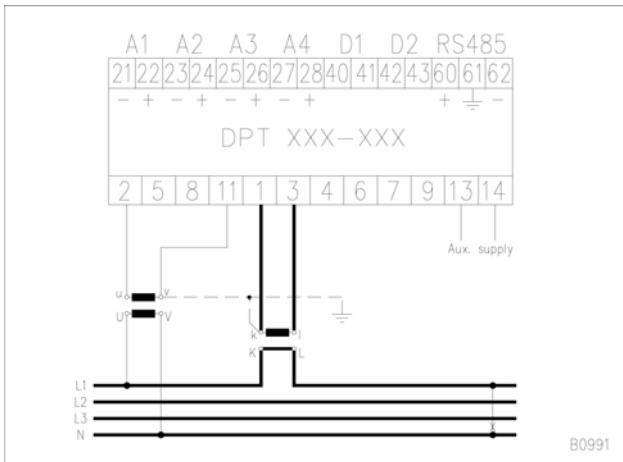

external voltage and current transformers

3-wire system, 2 element asymmetric load (D)

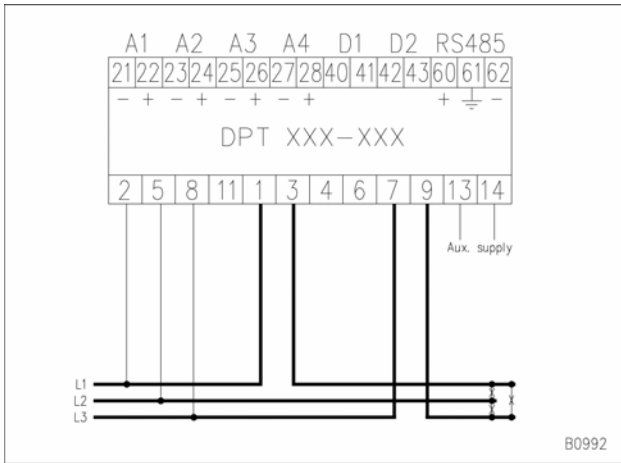

direct connected

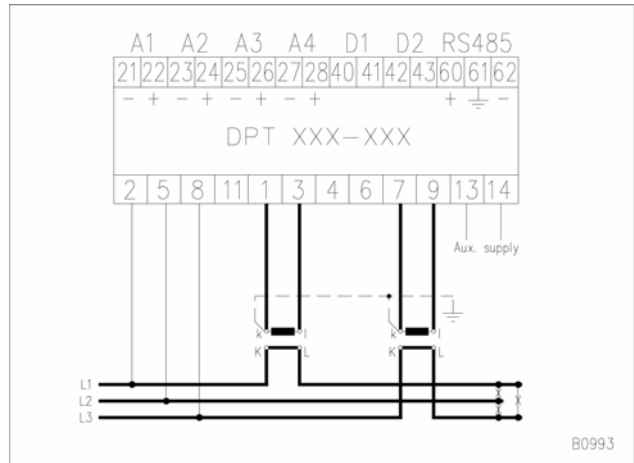

direct connected voltages and external current transformers

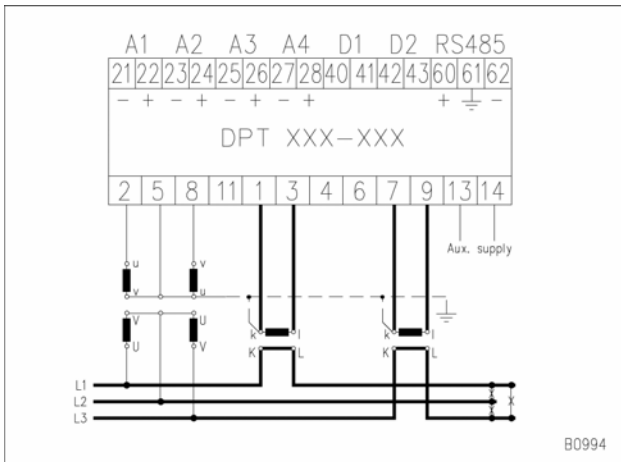

Two external voltage and current transformers

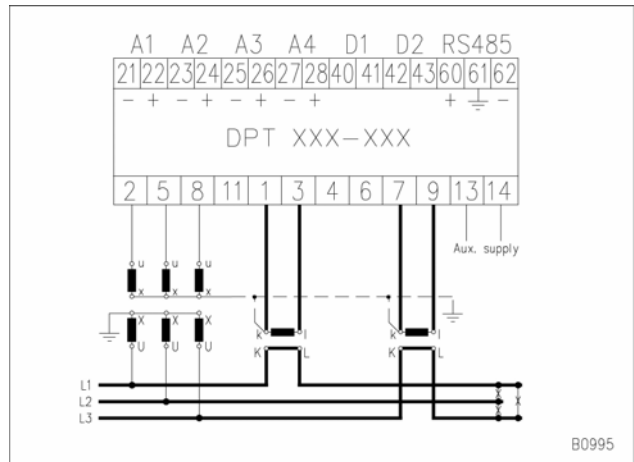

Three external voltage transformers and two current transformers

3-wire system, 2 element balanced load (U12-U23-I)

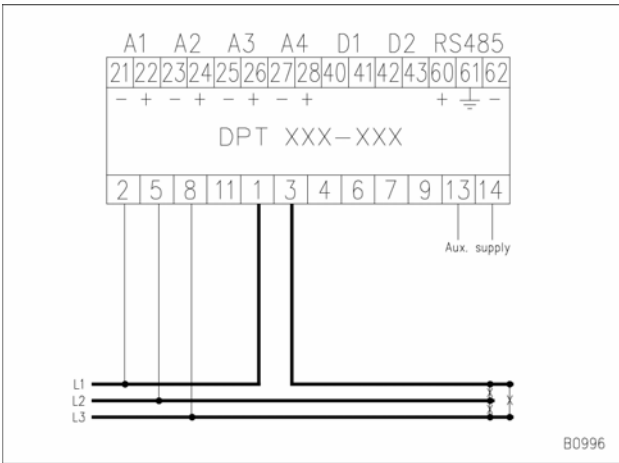

direct connected

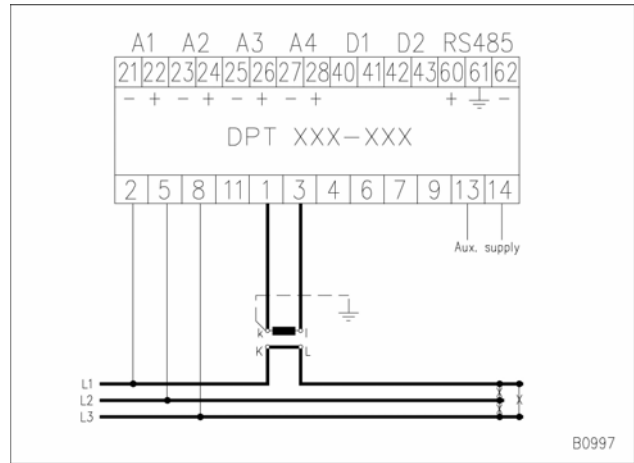

direct connected voltages and external current transformer

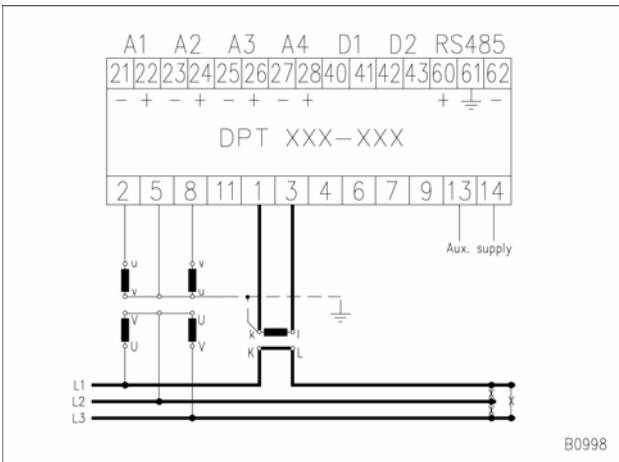

external voltages and current transformers

3-wire system, 2 element balanced system and load (U12-I1)

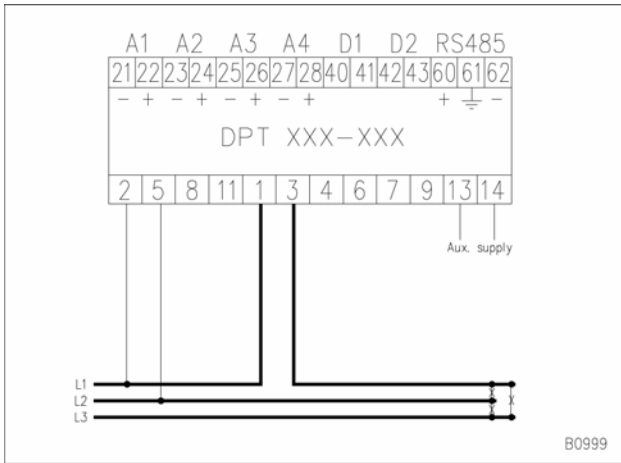

direct connected

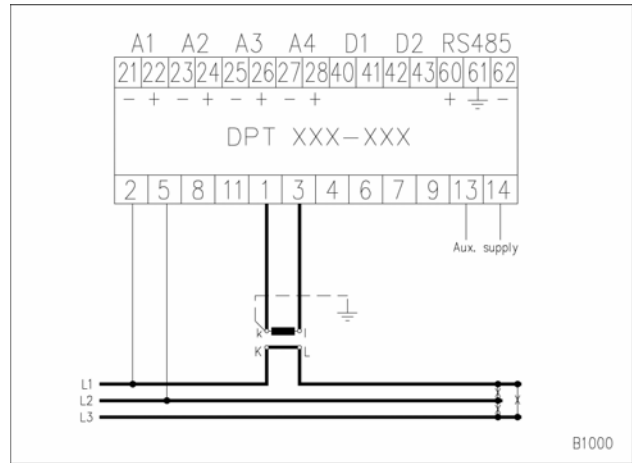

direct connected voltage and external current transformer

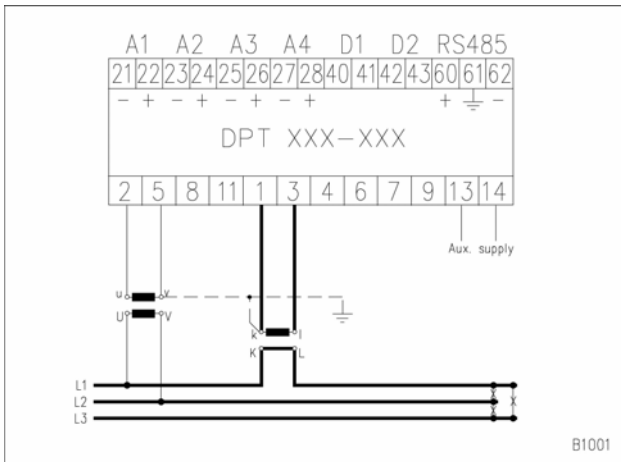

external voltage and current transformers

3-wire system, 2 element balanced system and load (U23-I1)

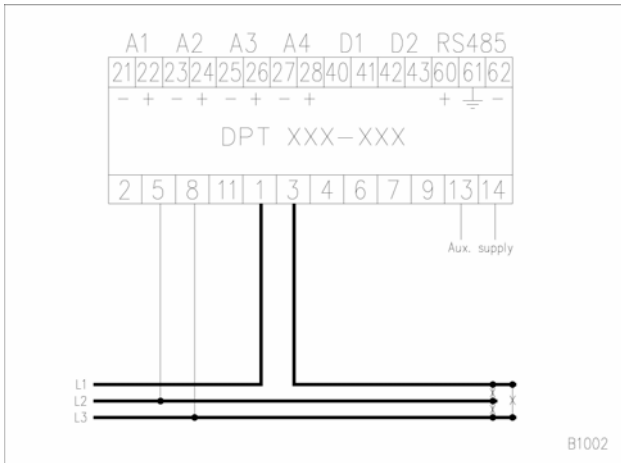

direct connected

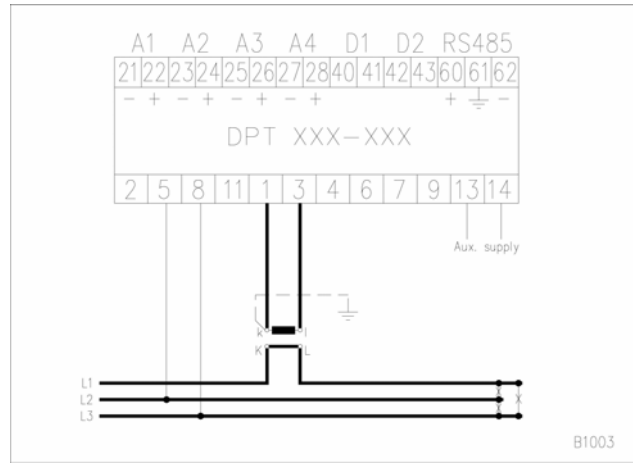

direct connected voltage and external current transformer

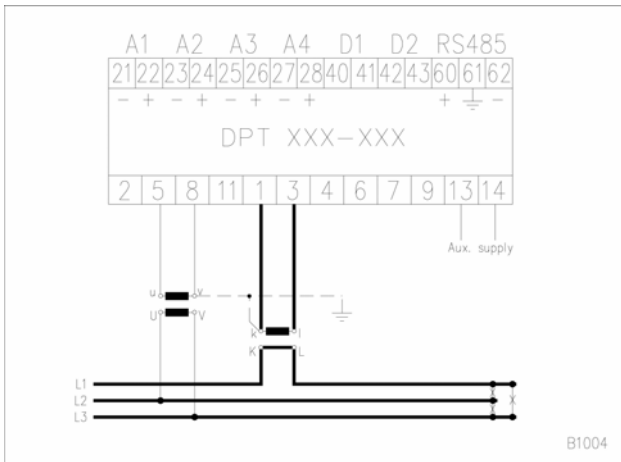

external voltage and current transformers

3-wire system, 2 element balanced system and load (U31-I1)

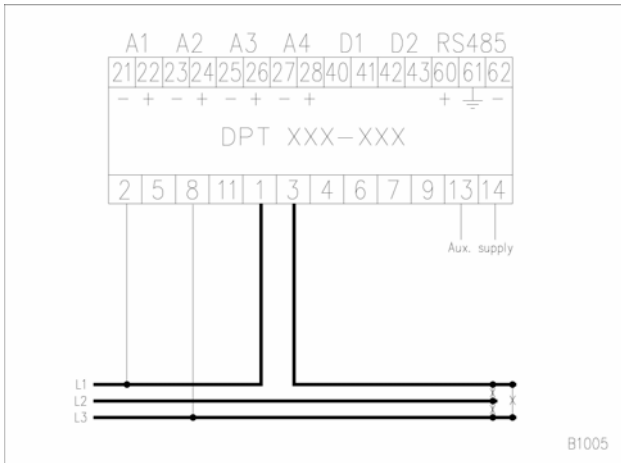

direct connected

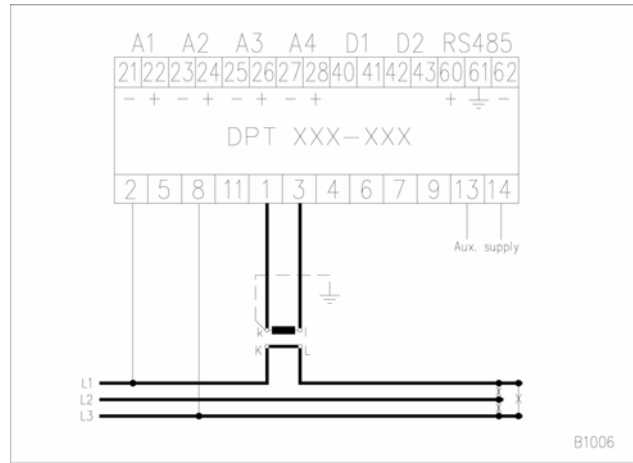

direct connected voltage and external current transformer

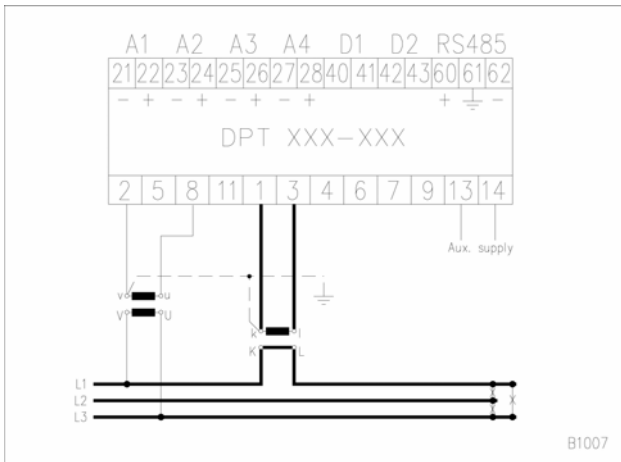

external voltage and current transformers

Single phase system

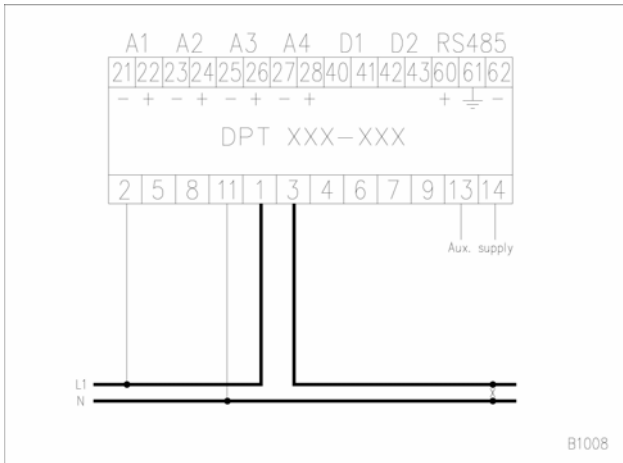

direct connected

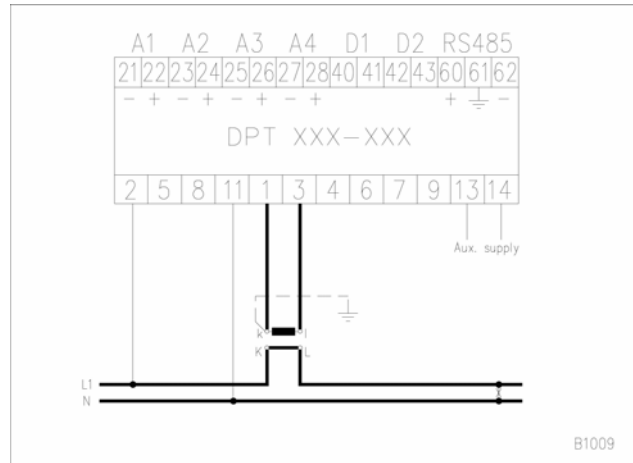

direct connected voltage and external current transformer

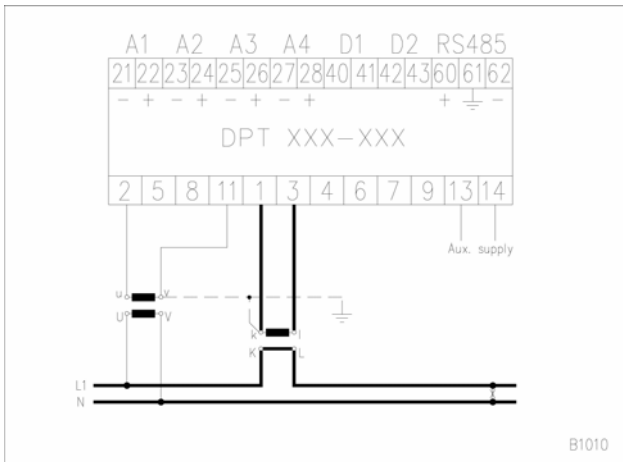

external voltage and current transformers

Appendix C - Measured Quantity Definitions

Current and voltage

RMS values for current and voltage are calculated as the root of the sum of squares for the harmonic components up to the 31th harmonic.

I_1 The current's first harmonic component (fundamental) specified as peak value.

I_2 The current's second harmonic component specified as peak value, has doubled frequency compared to the first harmonic.

$$I_{RMS} = \frac{\sqrt{(I_1^2 + I_2^2 + \dots + I_{31}^2)}}{\sqrt{2}}$$

$I1$ RMS Current in L1 (always positive).

$IS1$ RMS Current in L1 with sign of power P1.

I System Current (always positive).

IS System Current with sign of power P1.

$$I = \frac{I1 + I2 + I3}{3}$$

For voltage all definitions and formulas above are used.

Power

Harmonic component power

The calculations below are for active power, the calculations for reactive are identical except for that cos-functions are replaced with sin-functions.

$P1$ Active power in L1.

$P1_n$ Active power in L1 is calculated for harmonic component n.

$PA1_n$ Power phase angle between harmonic component $U1_n$ and $I1_n$

3-element method:

$$P1_n = U1_n \cdot I1_n \cdot \cos(PA1_n)$$

$$P1 = \sum_{n=1}^{31} P1_n$$

2-element method:

For 2-element method, only the total power is calculated in each harmonic component.

P_n Total active power is calculated for harmonic component n.

$\varphi1_n$ Phase angle between harmonic component $U12_n$ and $I1_n$

$\varphi2_n$ Phase angle between harmonic component $U32_n$ and $I3_n$

$$P_n = U12_n \cdot I1_n \cdot \cos(\varphi1_n) + U32_n \cdot I3_n \cdot \cos(\varphi2_n)$$

$$P = \sum_{n=1}^{31} P_n$$

Active and reactive power

Active and reactive power is calculated as the sum of harmonic component power up to 31st harmonic. The calculation is made with plus and minus signs, where negative power represents export direction and positive represents import direction.

P Total active power
 $P1$ Active power in L1
 Q Total reactive power
 $Q1$ Reactive power in L1

$$P = P1 + P2 + P3$$

$$Q = Q1 + Q2 + Q3$$

For 2-element meters, two elements are added instead of three.

Apparent power

S Total apparent power
 $S1$ Apparent power in L1

$$S = S1 + S2 + S3$$

$$S1 = U1_{RMS} \cdot I1_{RMS}$$

Demand of power

T Integration period in hours
 $P1$ Active power in L1
 $DP1$ Demand of P1
 $MDP1$ Maximum demand of P1

$$DP1 = \frac{1}{T} \int_0^T P1(t) dt \quad \text{Average of P1 (with sign!).}$$

$$MDP1 = \text{MAX}(DP1, MDP1) \quad \text{Max value of DP1 since reset / power on.}$$

The other phases and system is defined identically. This applies to reactive and apparent power as well.

A simplified variant of demand is to measure the current only. To satisfy these needs there is a demand of current.

$DI1$ Demand of I1
 DI Demand of I system

Energy

Energy is calculated by integrating power (P, Q and S) over time.

Definition of quadrants

The term phase angle is described under its own heading below.

Quadrant I: phase angle 0–90°

Quadrant II: phase angle 90–180°

Quadrant III: phase angle -180–(-90)°

Quadrant IV: phase angle (-90)–0°

Active energy

Active energy is calculated for import and export. The direction is controlled by the sign for active power (+ import, – export).

Active energy import: quadrant I and IV

Active energy export: quadrant II and III

Reactive energy

Reactive energy is calculated for four quadrants. The quadrant is controlled by the sign for active and reactive power (e.g., active power ≥ 0 and reactive power ≥ 0 corresponding to quadrant I).

Reactive energy import: quadrant I and II

Reactive energy export: quadrant III and IV

Reactive energy inductive: quadrant I and III

Reactive energy capacitive: quadrant II and IV

Apparent energy

Apparent energy is calculated for import and export. The direction is controlled by the sign for active power; apparent energy is registered for the direction that the active energy has during the same period.

Apparent energy import: quadrant I and IV

Apparent energy export: quadrant II and III

Power factor

Active power factor

$$PF = P / S$$

With negative active power, the active power factor is negative.

Reactive power factor

$$QF = Q / S$$

With negative reactive power, the reactive power factor is negative.

Active power factor alternative definition

$$LF = \text{sgn } Q \cdot (1 - |PF|)$$

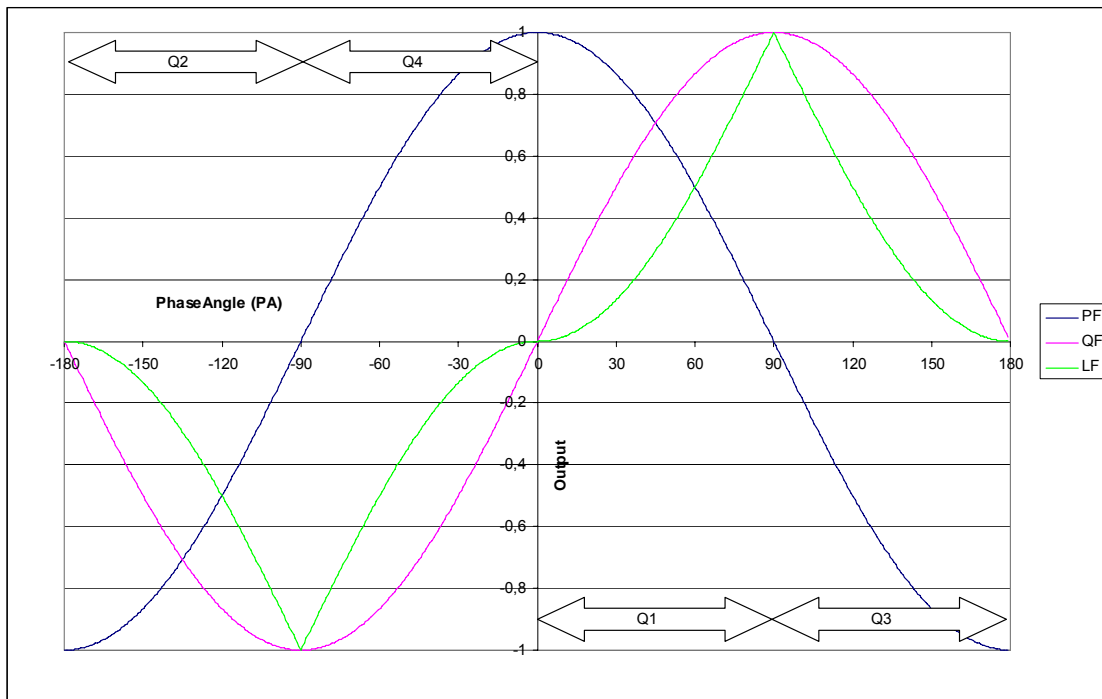

Phase angle

Phase angle values are between -180° and 180° ($-\pi$ rad and π rad).

Power phase angle

$$PA1 = PAU1 - PAI1$$

Phase angle, or power phase angle, for an element is calculated from the fundamental phase angles.

$$PA = \arctan(P_{fund} / Q_{fund})$$

Total phase angle is calculated from fundamental power.

Phase angle voltage and current

The phase angles on voltages and currents use PAU1, phase angle for voltage L1, as reference (0°). For unity power factor, the angles for PAU1, PAU2, PAU3 and PAI1, PAI2, PAI3 are 0° , -120° and 120° . An inductive load does not affect voltage phase angles, but PAI1, PAI2, PAI3 could be -20° , -140° , 100° . With this example the power phase angle would be $PA1 = 0 - (-20^\circ) = 20^\circ$.

THD

Total harmonic distortion, THD, is a measure of the harmonic content in a signal.

$$THD = \frac{\sqrt{I_2^2 + I_3^2 + \dots I_n^2}}{\sqrt{I_1^2 + I_2^2 + \dots I_n^2}} \cdot 100\%$$

Where $I_1 \dots I_n$ are the current's harmonic components. The calculation is made in the same ways for current and voltage.

THD values are 0 - 100%.

Appendix D – Material Declaration

Enclosure

Polycarbonate (Macrolon)

Flammability class: V-0 acc. to UL94, self-extinguishing, non-dripping, free of halogen

Connection terminals

Terminals	Steel
Cage clamps	Brass
Screws	Brass

Appendix E - Applicable standards and regulations

(industrial environments)

IEC/EN 60688	Electrical measuring transducers for converting AC electrical quantities to analogue or digital signals
IEC/EN 61010-1	Safety requirements for electrical equipment for measurement, control and laboratory use. Part1: General requirements
IEC/EN 60529	Degrees of protection provided by enclosures (IP code)
IEC/EN 60068-1	Basic environmental testing procedures for electronic...
IEC/EN 60068-2-1	Test A: Cold
IEC/EN 60068-2-2	Test B: Dry heat
IEC/EN 60068-2-3	Test Ca: Damp heat, steady state
IEC/EN 60068-2-6	Test Fc : Vibration (sinusoidales)
IEC/EN 60068-2-27	Test Ea : Shock
IEC/EN 62053-31	Pulse output devices for electromech./ electronic meters (2-wire)
IEC/EN 61326-1	^{a) c)} Electrical equipment for measurement, control and laboratory use - EMC requirements
IEC/EN 61000-6-2, -6-4	Electromagnetic compatibility (EMC) Generic standards for industrial environments ^{a)} Part 6-2: Immunity Table 1-4 ^{b)} Part 6-4: Emission Table 1
^{a)} IEC/EN 61000-4-2	Electrostatic discharge immunity test
^{a)} IEC/EN 61000-4-3	Radiated RF-electromagnetic field immunity test
^{a)} IEC/EN 61000-4-4	Electrical fast transient / burst immunity test
^{a)} IEC/EN 61000-4-5	Surge immunity test
^{a)} IEC/EN 61000-4-6	Immunity to conducted disturbances, induced by RF-fields
^{a)} IEC/EN 61000-4-8	Power frequency magnetic field immunity test
^{a)} IEC/EN 61000-4-11	Voltage dips / interruptions/ variations immunity tests
^{b)} CISPR 16	Spec. for radio disturbance/immunity..limit..methods....apparatus
^{b)} CISPR 22	Spec. for radio disturbance/immunity..limit..methods...info. technology
^{c)} CISPR 11	Spec. for radio disturbance/immunity..limit..methods..industrial, scientific and medical equipment.
EN50160	Power quality standard
DIN 40 110	Quantities used in alternating current theory; two-line circuit
DIN 43 807	Markings for switchboard, meters, measuring transducers
UL 94	Plastic flammability standard (for parts in transducer devices)

Appendix F – Approvals and certificates

YADAV MEASUREMENTS PVT. LTD

YMPL/147495/26987A

YMPL/147496/26988A

YMPL/159049/27420

YMPL/159049/27421

YMPL/159049/27422

YMPL/159049/27423

YMPL/162259/27457

YMPL/173109/27783

Appendix G – Technical specification

Safety

The current inputs are galvanically isolated from each other and to any other internal or external potential. The voltage input group is galvanically isolated to any other internal or external potential. The analog and digital outputs and communication ports are isolated from each other and to any other internal or external potential.

WARNING: Live parts inside transducer cover. Always disconnect all wires carrying dangerous voltages if opening the transducer. Note that all warranties will be obsolete if the transducer has been opened.

WARNING: This is a class A product. In a domestic environment this product may cause radio interference in which case the user may be required to take adequate measures.

Measurement generally

Accuracy	Class 0.2, Class 0.5
Frequency	50/60 Hz (45-65 Hz)
Measurement True RMS	Up to 31 st harmonic
Measurement category	CATIII ≤ 300VAC (versus earth), CATII ≤ 600VAC (versus earth)

Voltage circuit

Nominal measuring voltage (U_N)	
3-wire system:	3x100-693 V
4-wire system:	3x57,7/100-3x400/693 V
Range:	0% – U_N – 120%
Input impedance:	400k Ω (per phase)
Consumption:	≤ $U^2/400k\Omega \pm 3\%$ (per ph) (W)
Max overload voltage	1.2 x U_N continuously 1.5 x U_N during 10 s with max. 10 attempts with 10 s between 2 x U_N during 1 s with max. 10 attempts with 10 s between.
Starting voltage	0.25 V
Connector	screw terminals for ≤ 6 mm ²

Current circuit

Nom. measuring current (I_N)	1-5 A
Measuring range	0 - 200% of I_N
Consumption	≤ $I^2 \times 0.01\Omega$ (per phase)
Max overload current	2 x I_N continuously 20 x I_N during 1 s with max. 10 attempts with 100 s between 40 x I_N during 1 s with max. 5 attempts with 300 s between.
Starting current	4 mA
Connector	screw terminals for ≤ 6 mm ²

Auxiliary supply

Voltage range	40-276 VAC/VDC
AC frequency	45 – 65 Hz
Max burden	≤ 12VA / 7W
Inrush current	< 35 A / 0.3 ms

Analogue outputs

Number of outputs	4
Type	current /voltage bi-polar
Max voltage at open output:	≤ ±20V
Max over-driven output	≤ ± 125% (hardware limiter)
Load influence	≤ 0,1%
Range/Load (current outp)	±20mA / ≤ 750 Ω ±5mA / ≤ 3k Ω ±2mA / ≤ 7,5k Ω
Range / Load (voltage outp)	±10V / ≥ 2k Ω ±2V / ≥ 400 Ω
Residual ripple	≤ 0,4 % (peak to peak at full load)
Auxiliary voltage influence	≤ 0,1%
Temperature coefficient	≤ 0,01% extra per deg C
Programmable response time (t_{99})	200 ms, 300 ms, 600 ms, 900 ms, 1.2s, 1.5s, 2s, 5s, 10s, 30s

Digital outputs

Number of outputs	2
Accuracy	0.5s
Type	Solid-state MosFET relay, bi-directional rating 0,2 A, 110 VAC/DC (Varistor protected)
Pulse length	10 ms - 1 s
R_{ON}	8 Ω (max)



Cewe Instrument AB
Box 1006 • SE-611 29 Nyköping • SWEDEN
Tel: +46 155 775 00 • Fax: +46 155 775 97
e-mail: info@ceweinstrument.se • www.ceweinstrument.com

