



VoiceCom System User Manual



Designed and Manufactured in Australia by
Ampcontrol Pty Limited ACN 000 915 542
Phone: (02) 4956 5899 Fax: (02) 4956 5985
www.ampcontrol.com.au

No copies of the information or drawings
within this manual shall be made without the
prior consent of Ampcontrol.

USER MANUAL

E06397 ISSUE 4 15/8/08

VCA_Manual_Issue_4_E06397_15/8/08.pdf

Copyright Notice

No part of this publication may be reproduced, transmitted or transcribed into any language by any means without the express written permission of Ampcontrol Pty Ltd, 250 Macquarie Road Warners Bay, NSW 2282, Australia.

Disclaimer

Ampcontrol Pty Ltd will make no warranties as to the contents of this documentation and specifically disclaims any implied warranties or fitness for any particular purpose.

Ampcontrol further reserves the right to alter the specification of the system and/or manual without obligation to notify any person or organisation of these changes.

Before You Begin

We would like to take a moment to thank you for purchasing the VoiceCom Communication System. To become completely familiar with this equipment and to ensure correct operation, we recommend that you take the time to read this user manual thoroughly.

CRN: 4820

Software Version 4.0

CHAPTER 1 – OVERVIEW OF THE VOICECOM SYSTEM.....	4
System highlights	4
VCA features	4
VAA features	4
Applications	4
The VoiceCom Controller – VCA.....	5
Key Functions	5
Controller Terminals	5
PC Software	6
Modbus	6
The VoiceCom Amplifier – VAA Overview.....	6
Key Functions	6
Keypad	6
Display	6
Local Configuration	6
Advanced Battery Management.....	6
CHAPTER 2 – INSTALLATION	7
VCA Physical installation.....	7
VCA Connections and Wiring.....	7
Digital Inputs	8
Digital Outputs.....	10
110VAC Power Inlet and Relay Outputs	10
Case Earth	10
Data Communication Ports	11
Communication Line 1 and 2 I.S. Interfaces	11
I.S. Keypad Interface.....	13
I.S. Audio Interface.....	14
I.S. Earth	14
VAA Physical Installation.....	15
VAA Connections and Wiring.....	16
CHAPTER 3 - VCA OPERATION	17
HMI Features	17
Front Panel.....	17
Display and Main Menu Page	18
Menu System	19
Navigation	19
Voice Message Information Page – Level 1.....	19
VCA Message Bank Download Page – Level 1	20
Line Status, VAA Status and Programming Pages – Level 2 and 3.....	20
Line Status Page.....	20
VAA Address Setup Page	21
VAA Status Pages.....	23
VAA Operational Status Values	24
VAA User Programmable Settings	24
Setting VAA parameters:.....	25
Modbus Communication Status – Level 4.....	26
Relay Outputs and Digital I/O – Level 5	27
Relay Outputs Page	27
Digital Output Page	27
Digital Inputs Page	28
VCA Configuration – Level 6.....	29
Changing VCA Settings.....	32
CHAPTER 4 – VAA OPERATION	33
VAA Amplifier Module	33
VAA Features.....	33
The LCD.....	34

Display Messages	35
The Keypad	35
VAA Setup Mode	36
Enter Setup Mode	37
Changing the Settings	37
VAA Battery Pack	38
Battery Pack Features:	38
Removing and Connecting Battery Pack from Amplifier Module	39
VAA Battery States – Voltage and Charge	39
Auto-shutoff	40
Sleep Mode	40
Waking the VAA	40
Power Supplies	40
CHAPTER 5 – PRE-START ALARM OPERATION	41
Pre-start Alarm Configuration	41
Initiating a Pre-start Alarm	41
Verifying the Pre-start Alarm Request Input	42
VAA Pre-start Alarm Sounding and Confirmation	42
Pre-Start Alarm Confirmation	43
Verifying the Pre-start Alarm While Active	43
Verifying the Pre-start Alarm Later	44
Pre-start Alarm Operation Examples	45
Example 1 – a successful pre-start alarm	45
Example 2 – a failed pre-start alarm	45
Example 3	46
CHAPTER 6 – CREATING AND DOWNLOADING VOICE MESSAGES	47
Recording and Editing Voice Messages	47
VCA Message Bank Editor	47
Voice Message Bank Editor Installation	47
Creating a Message Bank	48
Downloading and Uploading the Message Bank	52
Downloading	52
Uploading	54
CHAPTER 7 – TROUBLESHOOTING	55
APPENDIX A – COMMISSIONING	57
VAA Configuration	57
Address Setup	57
Volume, Microphone Gain and Audio Threshold	58
Charging Current	58
VCA Line Configuration	59
Pre-start Alarm Configuration	59
Service Factor	59
Pre-Start Warning Tone	60
Pre-Start OK Current Threshold	60
VCA Configuration Record	61
APPENDIX B – MODBUS	63
Configuration	63
VCA Modbus Read and Write Functions	63
Initiating Voice Messages and Voice Message Control	63
To initiate a voice message:	64
Stopping a voice message:	64
Message Queuing	64
Joining messages together:	64
Reading VAA Parameters	64
Modbus Tables	64
APPENDIX C – APPLICATION NOTES	72

Communication Line Configurations	72
Longwall	72
Conveyor	72
VAA Only (eg vehicle road, drift, etc)	72
Audio Interface/Audio Barrier	72
SCADA Displays	72
Voice Messages	72
Loading Voice Messages	72
APPENDIX D – MENU MAP	73
APPENDIX E– PARTS LIST	74
APPENDIX F – SPECIFICATIONS	75
VCA	75
Tones	75
APPENDIX G – I.S. APPROVALS	77

CHAPTER 1 – Overview of the VoiceCom System

The Ampcontrol designed VoiceCom system is a multi-station audio communication system suitable for long wall and conveyor message applications. The system's three principal functions include generating pre-start alarms, playing pre-recorded voice messages and one to many station communications. The system is comprised of two main components, the VCA VoiceCom Controller and VAA VoiceCom Amplifier field units.

System highlights

- 2 Intrinsically Safe communication lines
- Connection of up to 31 VAA field units per line
- User selectable pre-start alarm tones for each line
- Pre-start confirmation from all VAA units
- User recordable voice messages – up to 255 messages can be stored
- PC software to create voice message banks
- High quality audio output
- Advanced diagnostic and preventative maintenance features
- “Call Exchange” functionality

VCA features

- One compact unit controls pre-start alarms and voice messages
- 4 line backlit LCD display
- Tactile seven button integrated keypad (optional external keypad available)
- Easy to use menu system allowing access to system status and configuration pages
- 16MB flash memory for up to 25 minutes of voice message storage
- Monitor and configure VAA field units from VCA
- RS-232 interface for downloading voice messages from a PC
- RS-485 Modbus interface, allows control of voice messages and reading to system status by a PLC
- 110VAC operation
- Telephone exchange interface
- External I.S. keypad interface

VAA features

- Intrinsically Safe
- IP66 ingress protection rating when enclosed in an Ampcontrol stainless steel housing
- Powered using a sealed lead acid battery for high capacity and longer life
- LCD display showing operational status values such as line voltage, battery voltage and battery current
- Durable 4 button membrane keypad
- Dust and moisture protected microphone
- Connection for two external speakers
- Address, volume, microphone gain and charging current configurable at the VAA as well as at the VCA
- Compatible with most existing voice communication systems

Applications

- Long wall operations
- Conveyors
- Hazardous area communication

The VoiceCom Controller – VCA

Key Functions

The Controller's primary functions are to initiate and confirm pre-start alarms and play pre-recorded voice messages. The system's operation can be configured and monitored via the Controller's easy to navigate menu system. Users already familiar with Ampcontrol's Motor Protection and Integrated Protection Relay products may recognise the menu structure.

Controller Terminals

The Controller has a number of input/output and communication interfaces to suit most applications

- 12 edge triggered digital inputs for voice message control
- 2 pre-start alarm initiation digital inputs, one for each communication line
- 4 digital outputs providing system status indication
- 4 relay contacts providing pre-start alarm confirmation outputs and system status indication
- RS-232 3-wire port for downloading of voice messages
- RS-485 3-wire port for Modbus connection to a PLC
- 2 4-wire communication line terminals (Line 1 and Line 2) including a separate I.S. power supply connection for each line
- 2-wire audio interface connection to connect the VoiceCom System to a telephone exchange via an approved barrier
- 8 inputs for the connection external keypad control buttons and a lock switch (or the VCA Remote Keypad Module)

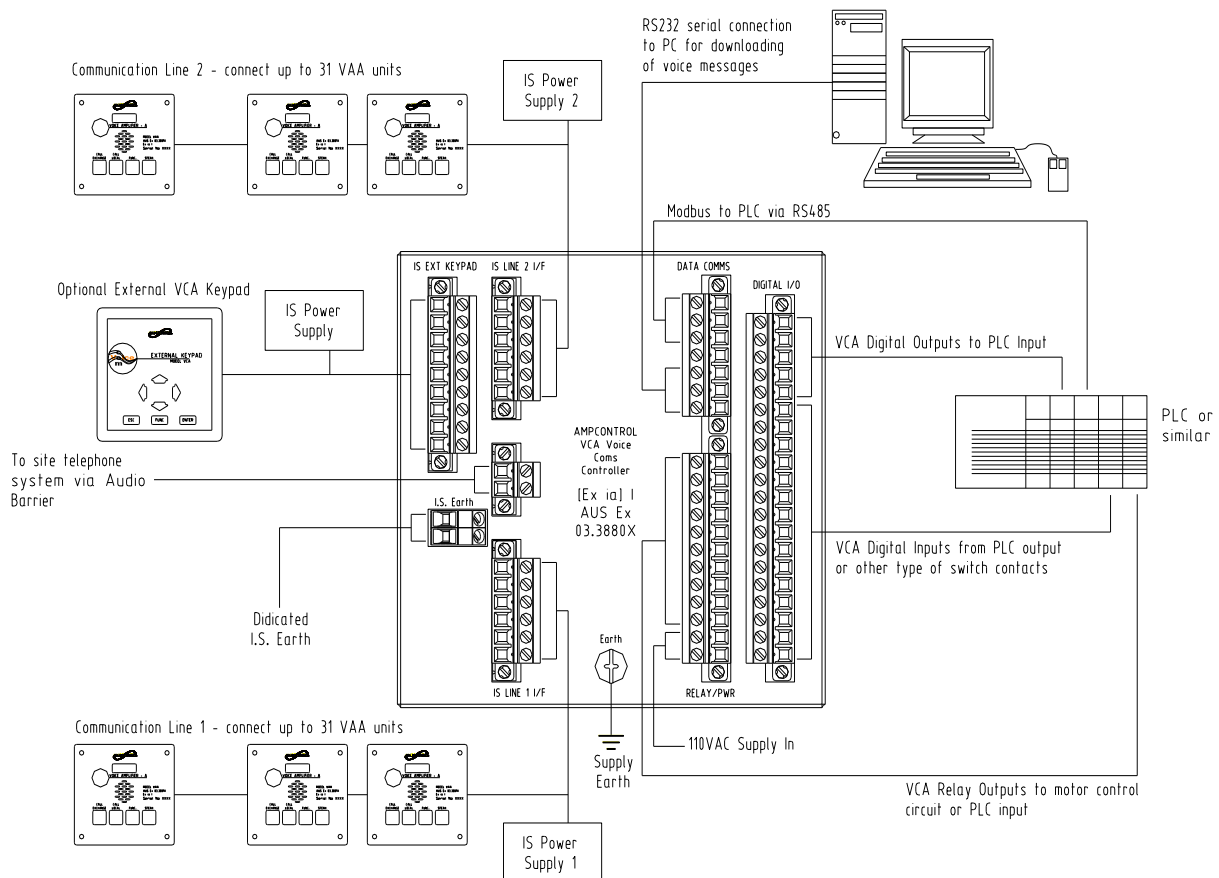

Figure 1 – VoiceCom system connection diagram

PC Software

The Controller is supplied with the VCA Message Bank Editor Windows PC software. The software enables the user to create, edit and download voice message banks to the Controller. A separate PC program is required for the recording of individual voice message audio files before the voice message bank can be created.

Modbus

Most of the Controller's functionality can be controlled and monitored via a Modbus protocol connection. This includes playing voice messages and reading VAA operational parameters of all connected VAA units. This Modbus data can be used for trending via a PLC, allowing for preventative maintenance by giving early indication of cable failures or VAA batteries that may be ready replacement.

The VoiceCom Amplifier – VAA Overview

Key Functions

The VAA sounds pre-start alarms and amplifies audio signals like voice messages and station-to-station communication. Unlike other communication systems where pre-start alarm and signalling tones are transmitted via the audio line, the VAA generates all pre-start alarm tones locally. The VAA has four volume levels and two microphone gain levels that can be configured, depending on the level of background noise. The VAA also has a seven level threshold setting that prevents unwanted noise from being amplified.

Keypad

Each of the four VAA keypad buttons also generates a different tone when pressed. The **SPEAK** button generates a brief tone when pressed and then a higher pitch tone when released to get the attention of other users. Pressing the **CALL LOCAL** button also generates a tone that can also be used to get the attention of other users. The **CALL EXCHANGE** button generates a low frequency tone for a short duration that can be used to open telephone circuits. The **FUNC** button, when pressed, closes one of the Controller's digital outputs. This output can be used to trigger an external event, such as prompting the PLC to initiate certain voice messages.

Display

The LCD display cycles through the VAA's key operating parameters such as the communication line voltage, battery voltage, battery current and a system digital communication "heart beat".

Local Configuration

As well as being configurable from the Controller, the VAA's programmable settings can also be changed at the VAA using the unit's programming mode.

Advanced Battery Management

The VAA's battery management facility allows the battery's charging current to be set by the user. The setting of the battery charging current depends on factors such as the output of the I.S. power supply and the number of VAA units connected to the communication line. The VAA can effectively disconnect the battery if its voltage falls below a pre-set level to prevent permanent battery cell damage.

CHAPTER 2 – Installation

This section covers the installation of the VCA and VAA. The various system wiring options are explained as well as the functions of the VCA and VAA connections. Appendix E lists drawings relevant to the installation and operation of the VoiceCom system.

VCA Physical installation

The controller can only be installed in the safe area. The required panel cut out is 135mm x 135mm. See drawing VCOM-A-040 for a panel cut out template with dimensions. To ensure that the installation meets the required IP65 rating, the gasket must be fitted between the controller's escutcheon and the panel. The controller is supplied with five mounting brackets each with a M5 x 40mm Phillips head screw. These brackets fitted as shown in Figure 2 below. The fifth bracket is supplied as a spare.

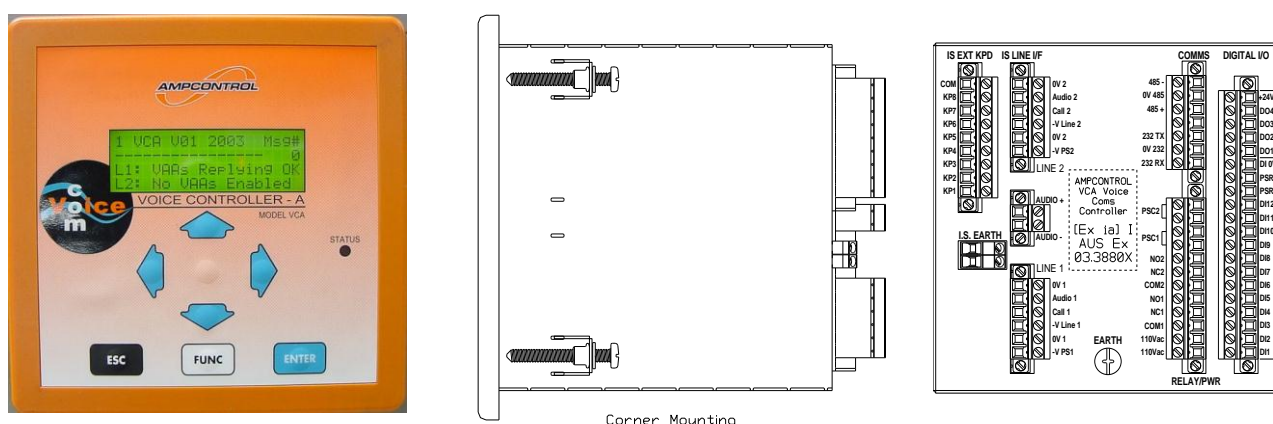

Figure 2 – VCA VoiceCom Controller (E08588) Front, Side and Rear

VCA Connections and Wiring

This section covers VCA terminal functions and wiring. All VCA connections are made at the rear of the VCA unit. VAA unit wiring can be found later in this manual. The VCA has eight terminal headers and is supplied with seven terminal plugs. The I.S. Earth terminal is the eighth header and is fixed to the rear of the VCA. There is also a mains earth connection point, which should not be confused with the I.S. Earth.

The eight terminal headers and case earth are shown in Figure 3. These are:

- | | | | |
|---|--|---|--|
| 1 | Digital Inputs and Output | 6 | Line 2 I.S. Communication Line Interface |
| 2 | Data Communication (RS-232 and RS-485) | 7 | I.S. External Keypad Interface |
| 3 | 110VAC Supply Power and Relay Outputs | 8 | I.S. Earth |
| 4 | Line 1 I.S. Communication Line Interface | 9 | Case Earth |
| 5 | I.S. Audio Interface (for telephone exchange circuit connection) | | |

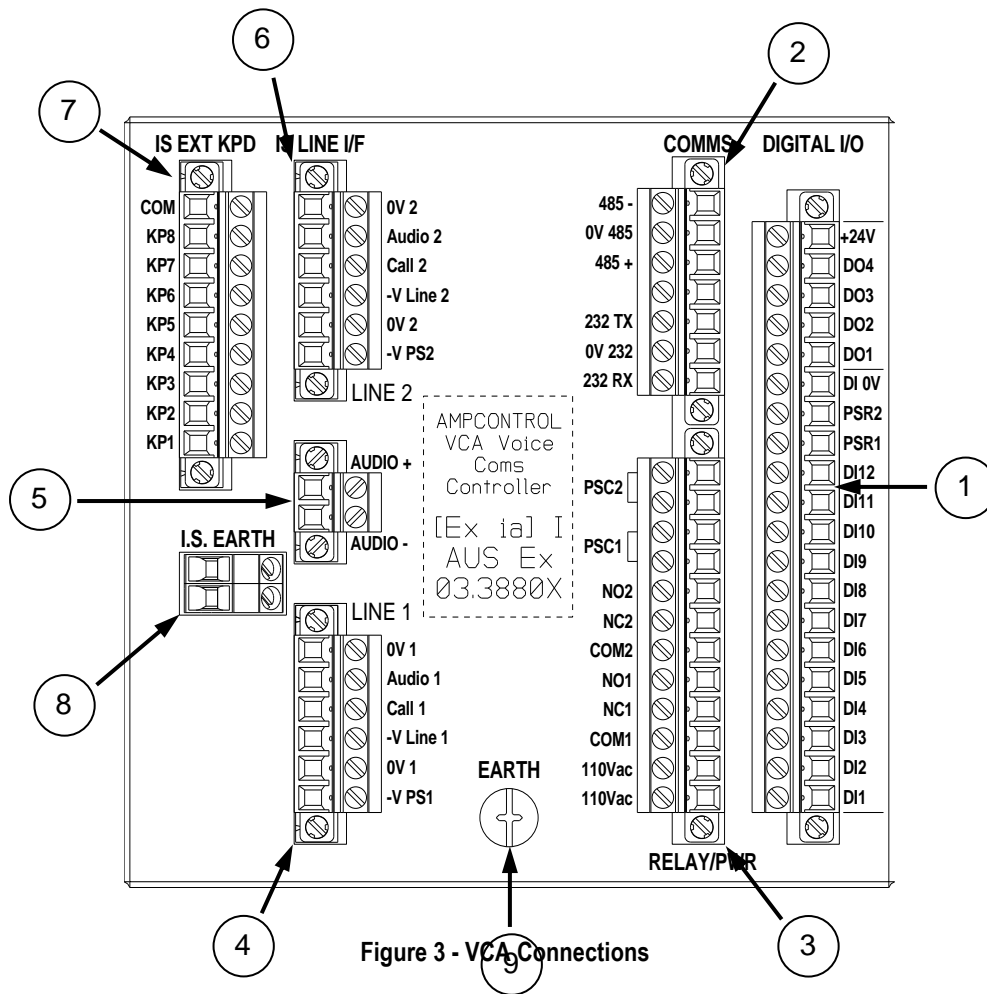

Figure 3 - VCA Connections

Digital Inputs

The controller has 14 digital inputs labelled DI1 to 12, PSR1 and PSR2. A 24VDC supply is required to assert these inputs. The negative side of this supply is connected to the 0V DI terminal. The positive side of the supply is applied to the digital input as required.

Inputs 1 to 12 are used for message initiation and are edge triggered. The voice message will not stop when the 24VDC is removed, nor will the message repeat if the 24VDC is held. These inputs will remain active for the duration of the voice message. Inputs PSR1 and PSR2 are used for pre-start alarm initiation and are active for as long as the input is asserted. The digital inputs can be wired in several configurations depending on the voice message initiation mode chosen. The connection options are listed in Table 1, Table 2 and Table 3. The three modes are as follows:

1. Digital Inputs/Modbus
In this mode, asserting digital inputs 1 to 12 plays messages 1 to 12 respectively. Messages 13 to 255 are initiated via the Modbus communication link.
2. Strobe
In this mode all messages, 1 to 255, can be played by setting up the voice message address as an eight bit binary number using digital inputs 1 to 8 and then using digital input 9 as a strobe to initiate that message. This allows relay logic to initiate voice messages if no Modbus communication facility is available.
3. Modbus
In this mode all messages, 1 to 255, are played via Modbus. Asserting digital inputs 1 to 12 will not initiate voice messages.

NOTE: Pre-start alarms cannot be initiated via Modbus. The PSR1 and PSR2 inputs must be used to initiate pre start alarms on Lines 1 and 2.

Table 1 - Connections for Digital Input/Modbus Mode

Terminal	Function
DI1 to DI12	Momentarily apply +24VDC (edge triggered inputs) to play voice messages 1 to 12 respectively
PSR1	Apply +24VDC to input and hold to play pre-start alarm down line 1
PSR2	Apply +24VDC to input and hold to play pre-start alarm down line 2
0V DI	0V common for all digital inputs (from negative side of 24VDC supply)

Table 2 - Connections for Strobe Mode

Terminal	Function
DI1 to DI8	Set up message address in binary where DI1 is the least significant bit. Apply and hold +24VDC to the inputs until strobe input has been asserted.
DI9	Momentarily apply +24VDC (edge triggered input) to play the message once the message address has been set up using inputs DI1 to 8.
DI10 to 12	Not used – no connection
PSR1	Apply +24VDC to input and hold to play pre-start alarm down line 1
PSR2	Apply +24VDC to input and hold to play pre-start alarm down line 2
0V DI	0V common for all digital inputs (from negative side of 24VDC supply)

Table 3 - Connections for Modbus Mode

Terminal	Function
DI1 to DI12	Not used – no connection
PSR1	Apply +24VDC to input and hold to play pre-start alarm down line 1
PSR2	Apply +24VDC to input and hold to play pre-start alarm down line 2
0V DI	0V common for all digital inputs (from negative side of 24VDC supply)

Digital Outputs

The four digital outputs, labelled DO1 to 4, provide indication of system status. These are transistor outputs. The positive side of a 24VDC supply must be connected to the terminal marked +24V. The negative side of the 24VDC supply is connected to the input or device to complete the circuit when the output turns on. See the figure below. The indication provided by these digital outputs can also be read via Modbus. Refer to the Modbus data table in Appendix B for the location of these digital output flags. However, they can be wired if Modbus communication is not available or for redundancy. The function of each digital output is as follows:

DO1 – asserted when a “Line Fault” occurs. Line Faults include faults such as the number of VAA communicating with the VCA being less than or greater than the number of VAAs online setting (*VAA # Reply Alarm*) or two or more VAA have the same address (*VAA Address Clash*). Refer to the VCA Operation and Troubleshooting chapters for more information on Line Faults.

DO2 – asserted when the “FUNC” button on a VAA is pressed. This output remains on for 5 seconds after the button is pressed. This could be used to trigger a function such as re-playing are the currently active voice messages.

DO3 – asserted while a voice message is playing. This output can assist the message control device, such as a PLC, with voice message queuing.

DO4 – this output current has no function.

110VAC Power Inlet and Relay Outputs

The RELAY/PWR header contains the terminations for VCA power supply connection and relay outputs. The following table describes the functions of the input/output terminals.

CAUTION – ELECTRICAL SHOCK HAZARD

Isolate the 110Vac supply before connecting or disconnecting.

Terminal	Function	
110Vac	Mains supply connection 110VAC 50Hz	
110Vac		
COM1	Relay 1 common	Energises while the controller is healthy – normally open and normal closed contacts. De-energises if a VCA or message bank memory fault occurs. See the Troubleshooting section.
NC1	Relay 1 N/C	
NO1	Relay 1 N/O	
COM2	Relay 2 common	Reserved for future use.
NC2	Relay 2 N/C	
NO2	Relay N/O	
PSC1	Relay 3 common	Normally open contact energises when Line 1 pre-start alarm has successfully sounded – pre-start alarm Line 1 confirmation output
PSC1	Relay 3 N/O	
PSC2	Relay 4 common	Normally open contact energises when Line 2 pre-start alarm has successfully sounded – pre-start alarm Line 2 confirmation output
PSC2	Relay 4 N/O	

See the Specifications section of this manual for detailed information on the specifications of digital inputs, digital outputs and relay outputs.

Case Earth

An EARTH connection point is provided adjacent to the 110Vac terminals for the connection of the mains supply earth.

Data Communication Ports

RS-232 – Message Bank Download

The controller has two data ports. The RS-232 port is used to connect the VCA to a PC for the downloading of the Voice Message Bank. The Voice Message Bank is a single file that contains all of the pre-recorded voice messages. This file is compiled and downloaded using the Voice Message Bank Editor PC program provided with the VCA. This function is normally carried out before the controller is installed and so it is not necessary to wire these terminals. However, the RS-232 terminals could be wired to a standard female DB9 9-way type socket mounted within the cubicle for easy connection to a PC via a standard RS-232 9-way serial cable. A ready made serial cable (p/n E09400) is available from Ampcontrol. A serial cable can also be easily assembled. Figure 4 details the DB 9 pins that are used for this RS-232 serial cable.

RS-485 – Modbus Communication

The RS-485 port is used to connect the controller to a Modbus capable control or SCADA system. The configuration of these two ports is described in the Refer to the VCA Operation chapter of this manual for information on how to configure the communication parameters for this port. Further information on using Modbus can be found in Appendix B. Table 4, below, lists the data port connections and Figure 4 shows the terminal wiring.

Table 4 - VCA Data Port Connections

Terminal	Function (w.r.t. the VCA)
485 -	RS-485 negative
0V 485	RS-485 common
485 +	RS-485 positive
No connection	Not used
232 TX	RS-232 transmit
0V 232	RS-232 common
232 RX	RS-232 receive

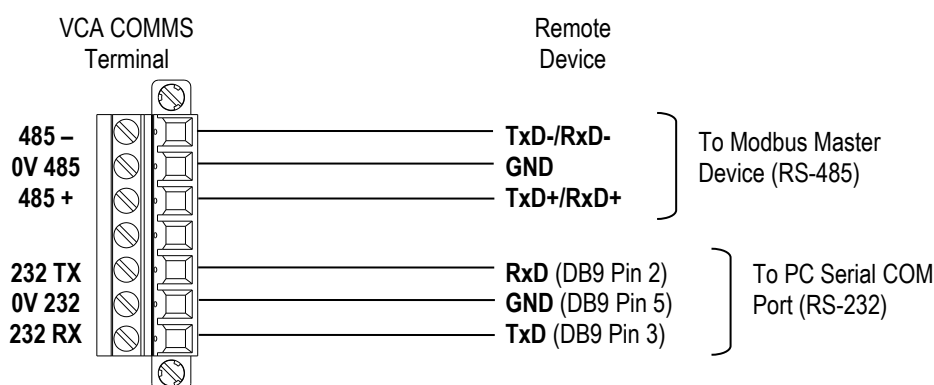

Figure 4 - VCA data communication wiring

Communication Line 1 and 2 I.S. Interfaces

Note: Refer to VCA Certificate of Conformity AUS Ex 03.3880X and VAA Certificate of Conformity Aus Ex 03.3881X for the correct installation and wiring of Intrinsically Safe VCA interfaces.

The controller has two intrinsically safe communication line interfaces, labelled LINE 1 and LINE 2. Each interface has six terminals: four for connection to the VoiceCom communication line and two for connection to an Intrinsically Safe power supply. Each line can support a maximum of 31 VAA units, depending on the cable length and power supply used.

Note: The output parameters of the I.S supply must match the input parameters of the VCA and the VAA. Refer to VCA Certificate of Conformity AUS Ex 03.3880X and VAA Certificate of Conformity Aus Ex 03.3881X for input parameters.

The VoiceCom intrinsically safe communication line consists of four cores commonly referred to as: 0V, Audio, Call (digital communication signals) and -V Line. The 0V and -V Line cores provide voltage for VAA battery charging. The Audio line carries the system audio signals. The Call line is the digital communication link between the controller and VAA units. This digital communication line runs the VoiceCom digital protocol, which allows the VCA to retrieve VAA operating parameters, such as voltage and current values. Table 5

Table 6 list the I.S. communication line interface terminations and Figure 5 shows the terminal wiring for LINE 1. The wiring for LINE 2 is identical.

NOTE: Each communication line must be powered by a separate I.S. power supply.

Table 5 - LINE 1 Communication Line Interface Connections

Terminal	Function	
0V 1	0V supply line 1	VoiceCom LINE 1
Audio 1	Audio line 1	
Call 1	Call/digital line 1	
-V Line 1	Negative supply line 1	
0V 1	I.S. power supply 1 positive input	
-V PS1	I.S. power supply 1 negative input	

Table 6 - LINE 2 Communication Line Interface Connections

Terminal	Function	
0V 2	0V supply line 2	VoiceCom LINE 2
Audio 2	Audio line 2	
Call 2	Call/digital line 2	
-V Line 2	Negative supply line 2	
0V 2	I.S. power supply 2 positive input	
-V PS2	I.S. power supply 2 negative input	

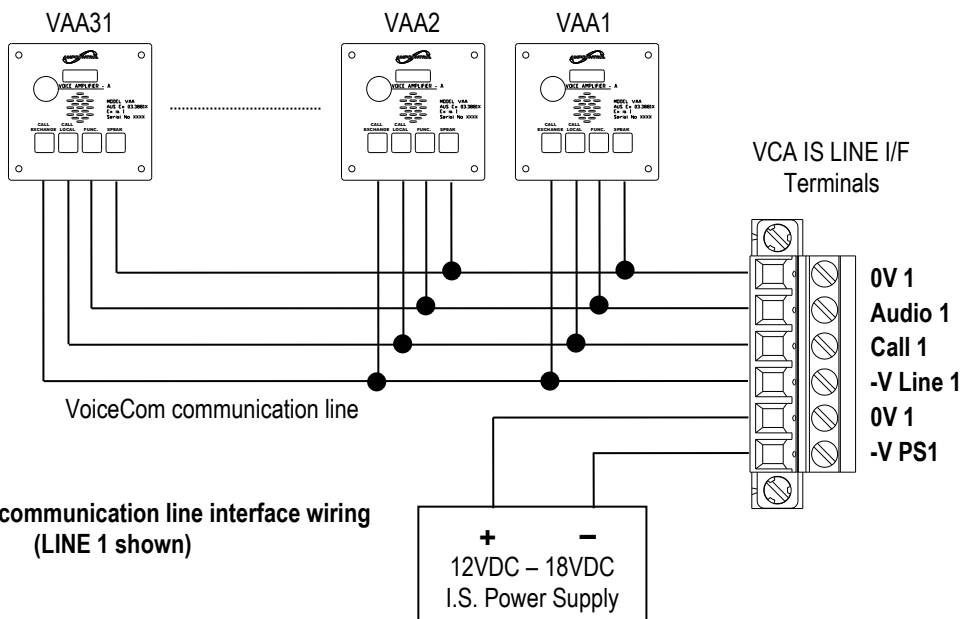

Figure 5 - I.S. communication line interface wiring (LINE 1 shown)

Note: The I.S. power supply can either be connected to the controller terminals, as shown in Figure 5, or to anywhere on the communication line to overcome the voltage drop caused by long lines. Refer to VCA approval drawing VCOM-Z-036 for I.S. power supply connection options.

I.S. Keypad Interface

The intrinsically safe keypad interface allows an external VCA keypad module (or suitable push buttons) to be installed in the hazardous area when the VCA is installed in a flameproof enclosure or the VCA keypad is otherwise inaccessible.

Table 7 shows the I.S. Keypad Interface termination and Figure 6 shows the wiring connections to the VCA Remote Keypad Module, available from Ampcontrol (p/n E08985). The keypad input functions are self explanatory. Input KP3 is the LOCK input. When the LOCK input is asserted, VCA configuration settings can be changed and Voice Message Bank files can be downloaded. Opening the LOCK input prevents any settings from being changed. The LOCK input should be wired to a key lock switch located adjacent to the VCA or behind the panel door.

The keypad inputs are powered from an I.S. power supply. One of the communication line I.S. power supplies can be used. For further wiring details refer to approval drawing VCOM-Z-036.

Table 7 - I.S. Keypad Interface Connections

Terminal	Function
KP1	UP button
KP2	LEFT button
KP3	Key LOCK (allows access to VCA settings)
KP4	RIGHT button
KP5	DOWN button
KP6	ENTER button
KP7	FUNCTION button
KP8	ESCAPE button
COM	IS power supply common

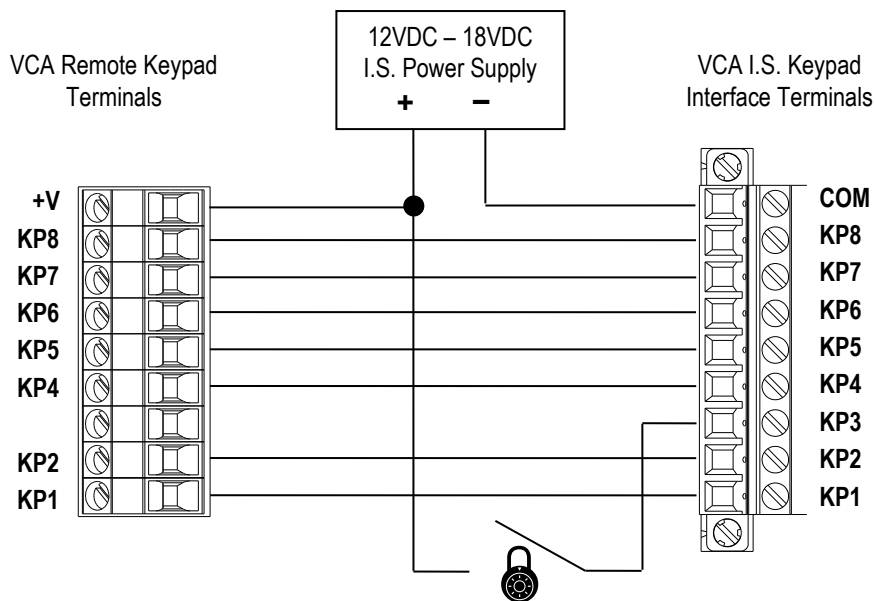

Figure 6 - I.S. keypad interface wiring to VCA Remote Keypad Module (E08985)

NOTE: The I.S. power supply connected to LINE 1 or LINE 2 can be used to for the VCA I.S. Keypad Interface.

I.S. Audio Interface

The intrinsically safe audio interface allows the VoiceCom System to be connected to a site-wide communication or telephone network. All audio signals originating from the VoiceCom System such as voice messages and VAA to VAA communication are output from the audio interface. Likewise, any audio signal input to the interface is broadcast over the VoiceCom System.

The VoiceCom Audio Barrier (p/n E09441) is required in order to connect the VCA I.S. Audio Interface to an intrinsically safe communication network. The VoiceCom Audio Barrier provides a number of connection options, such as allowing two independent VoiceCom communication lines to be connected together. This allows the audio from one VoiceCom system to be broadcast on the other system and vice versa. Note, however, that this does not enable a pre-start alarm to sound on the other VoiceCom system or the extension of the digital communication. Refer to Appendix C for more information on connecting the VoiceCom system to other communication systems.

Table 8 - I.S. Audio Interface Connections

Terminal	Function
AUDIO +	Audio line positive
AUDIO -	Audio line negative

I.S. Earth

The intrinsically safe earth terminals are used to connect the VCA to a local intrinsically safe earth. The I.S. earth should be a direct connection and should not be shared with other devices. A minimum of two 4mm² cores should be used.

NOTES:

1. Refer to Certificate of Conformity AUS 03.3880X for the correct installation and wiring of Intrinsically Safe VCA interfaces.
2. The I.S. Earth should not be confused with the VCA Case Earth. These earths should be kept separate.

VAA Physical Installation

The VAA comes in its own stainless steel enclosure. The VAA stainless steel IP66 enclosure includes two speakers and gland entries (p/n E09100). Other entry configurations can be accommodated. The VAA is also available as a panel mountable module (p/n E08831) for installation into an existing enclosure or panel door, shown in Figure 8. See drawing VCOM-A-040 for a panel cut out template with dimensions for the VAA and speakers.

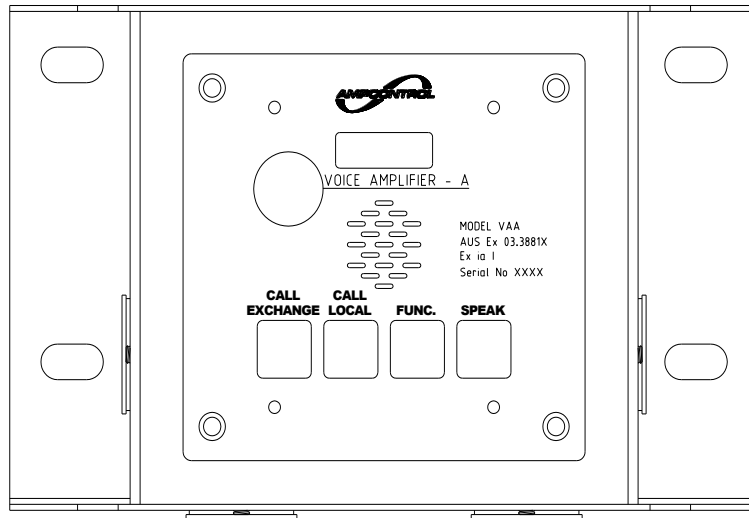

Figure 7 - VAA Speaker Enclosure (p/n E09100)

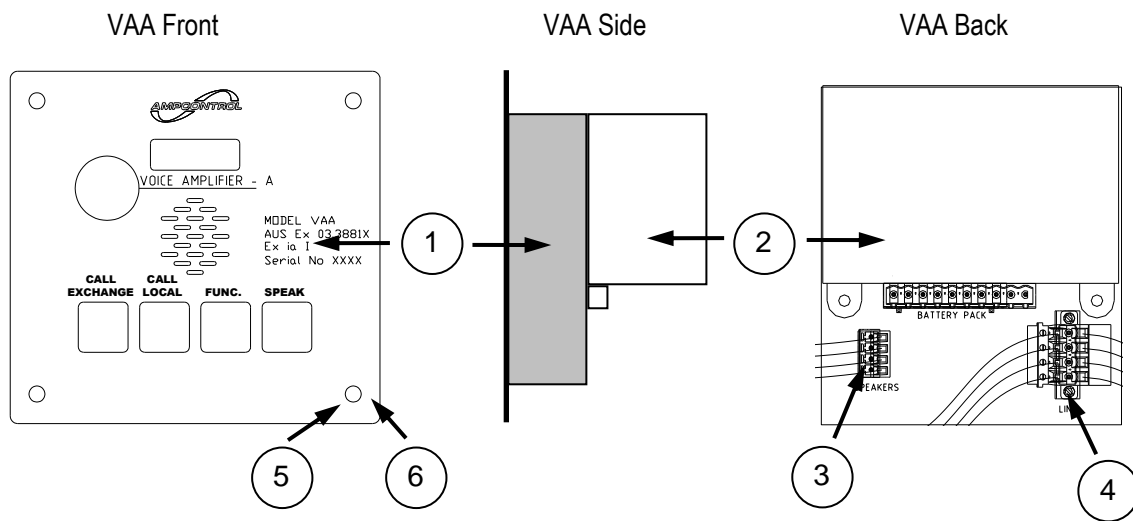

Figure 8 - VAA module (p/n E08831)

The VAA module consists of the following items:

- | | | | |
|---|---|---|---|
| 1 | VAA amplifier sub-assembly (p/n E08831) | 4 | 4-way double headed plug for VoiceCom communication line connection |
| 2 | 6V 1.2Ahr battery pack (p/n E08584) | 5 | 4 M6 x 20mm Allen head bolts |
| 3 | 4-way mini plug for speaker connection | 6 | 4 M6 nylon flat washers |

NOTE: Only the approved speakers can be connected to the VoiceCom VAA. Two 12 watt, 8 ohm speakers are available as a separate item (p/n E08783).

VAA Connections and Wiring

The VAA module has three connection headers, as shown in Figure 9 below:

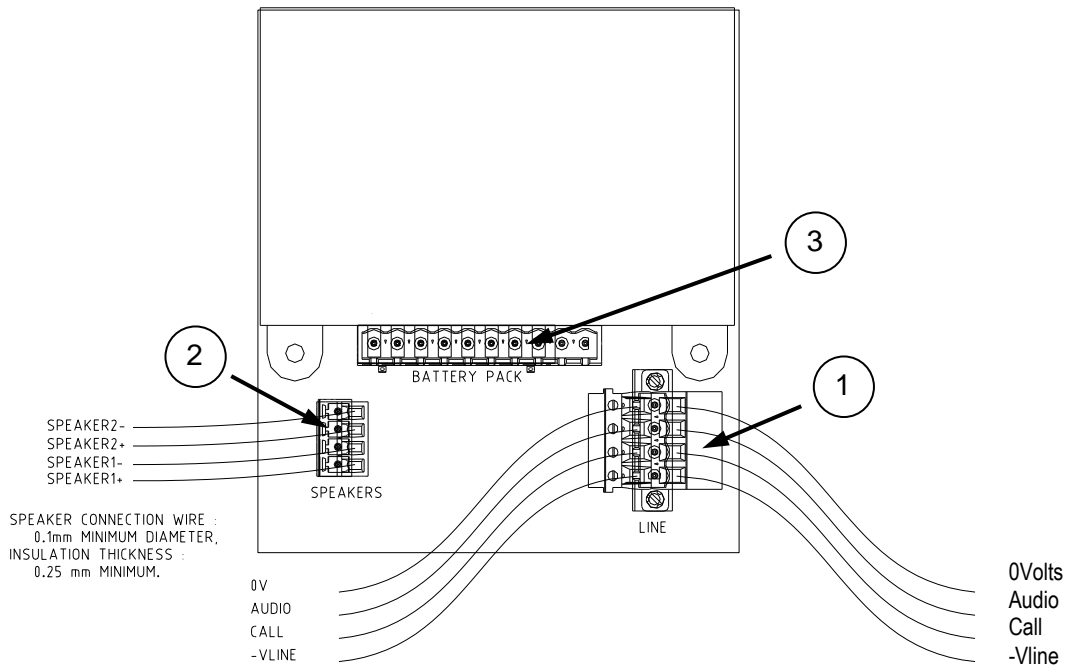

Figure 9 - VAA headers and communication line and speaker wiring

- 1 VoiceCom communication line (4-way)
- 2 Speakers (4-way)
- 3 Battery pack (10-way)

The communication line connections are listed in table 9 and speaker connections are listed in table 10 below.

Table 9 - VAA communication line connections

Terminal	Function
0V	0V supply line
AUDIO	Audio line
CALL	Call/digital line
-VLINE	Negative supply line

NOTE: The double headed communication line plug provides for separate termination of *in* and *out* cables and allows the communication line plug to be disconnected from the VAA module without breaking the line.

Table 10- VAA speaker connections

Terminal	Function
1 +	Speaker 1 positive
1 -	Speaker 1 negative
2 +	Speaker 2 positive
2 -	Speaker 2 negative

NOTE: The 4-way speaker terminal allows for the connection of two speakers. Wire length between the speakers and the VAA module should not exceed 300mm. The connection wire must be a minimum of 0.1mm in diameter and the wire insulation thickness must be a minimum of 0.25mm, as specified in the VAA Certificate of Conformity Aus Ex 03.3881X. Take careful note of the speaker polarity when wiring.

CHAPTER 3 - VCA Operation

The VoiceCom Controller version A, or VCA, as its name suggests, is the master controller of the VoiceCom system. From the VCA, the VoiceCom system can be easily configured and interrogated. It controls the operation of the pre-start alarm and it stores and plays pre-recorded audio messages. The VCA also allows for the VoiceCom system to be interfaced with a control system such as a PLC, which provides remote monitoring. The VCA's operation is best explained by looking at the all of the VCA status and configuration display pages.

HMI Features

Front Panel

The front panel of the VCA includes:

- 4 line, 20 character backlit LCD
- 7 button keypad
- Multicolour indicator LED (green, orange, red)

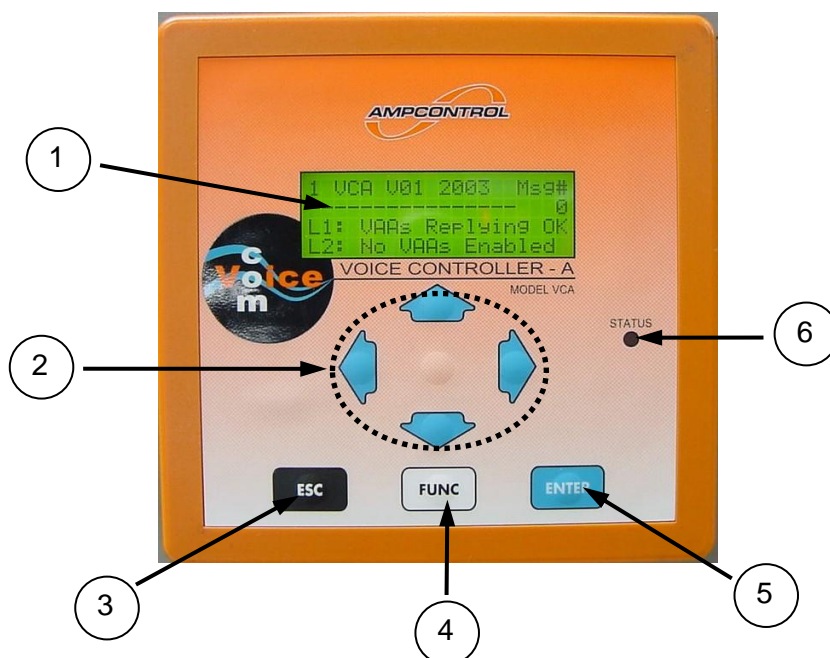



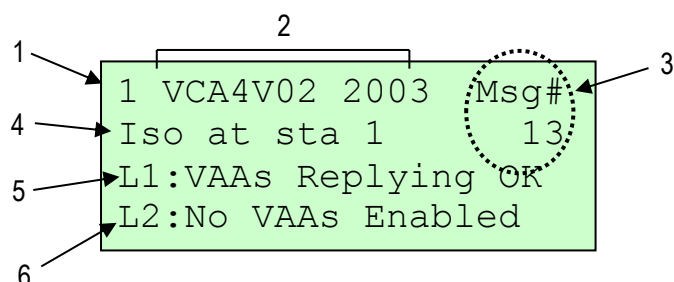

Figure 10 - VCA Front Panel

- | | |
|---|---|
| <p>1 Display – backlit LCD</p> <p>2  Keys – navigate through menu pages and toggle settings</p> <p>3  Key (Escape) – takes user back to Main Menu Page and for menu shortcuts</p> | <p>4  Key (Function) – used to view last pre-start alarm operation</p> <p>5  Key – used for changing and saving configuration settings and for menu shortcuts</p> <p>6 Status LED – VCA status indication</p> |
|---|---|



Display and Main Menu Page

When power is applied to the VCA the display defaults to the Main Menu page, shown in Figure 11. The backlight will turn on and remain active for 5 minutes after the last key press. Pressing any of the 7 keys will turn the backlight on. If not on the Main Menu page, the display will return back to the Main Menu page if no key is pressed for 5 minutes and the backlight will turn off.

NOTE: The only exception to this is when downloading Message Bank files. The display does not move off of the VCA Message Bank page when a connection between the VCA and a PC has been established.

- | | | | |
|---|---|---|-----------------------------------|
| 1 | Menu level number (on all pages) | 4 | Name of message currently playing |
| 2 | VCA Firmware version | 5 | Line 1 status messages and alarms |
| 3 | Number of audio message currently playing | 6 | Line 2 status messages and alarms |

Below are a list of the status and alarm messages that can be displayed for LINE 1 and LINE 2.

Table 11 - VCA Alarm Messages

Figure 11 - Main Menu Page

Message	Description
VAAs Replying OK	The number of VAAs that the VCA can communicate with matches the “# of VAAs to be online” parameter.
VAA Reply # Alarm	The number of VAAs that the VCA can communicate with is greater/less than the “# of VAAs to be online” parameter.
Address Clash	Two or more VAAs have the same address.
No VAAs Enabled	The “# of VAAs to be online” parameter is set to “None”.
PSW Active	A pre-start alarm is active.
PSW Healthy	The pre-start alarm has been successful. All the required VAAs confirmed sounding the pre-start alarm.
PSW Blocked	The maximum pre-start initiation time has been exceeded (30 seconds). Remove the pre-start alarm input and reapply to sound the pre-start alarm again. For every second that the pre-start alarm input is removed three seconds of pre-start alarm can be sounded if the input is reapplied. See the Pre-Start Alarm Operation chapter for more information on the operation of the pre-start alarm.

There are also a couple of VCA fault message that can appear on the second line of the display on the Main Menu page. Refer to the Troubleshooting chapter for more information on VCA faults.

Table 92 - VCA Hardware Fault Alarms

Message	Description
VCA mem. Error	An error has occurred with the VCA configuration memory.
Msg.Proc. Fail	A fault has occurred with the VCA Message Bank hardware.

The tricolour **Status LED** provides an indication of the health of the VoiceCom system.



- **Green** – both communication lines are healthy, no VAA reply alarms or address clashes
- **Orange** – a communication line fault exists, such as too few VAAs detected or an address clash
- **Red** – a VCA fault exists, such as a VCA memory error or Message Bank processor fault

Menu System

The VCA menu system consists of six menu levels. The menu level number is displayed in the top left corner of all VCA pages, except for the Voice Message Information page. Each menu level may contain one or a number of pages. A VCA menu map is provided in Appendix D. These levels are:

1. Main Menu page, Voice Message Information and Download pages
2. LINE 1 Status pages and LINE 1 VAA Programming pages
3. LINE 2 Status pages and LINE 2 VAA Programming pages
4. Modbus Communication page
5. Relay Outputs, Digital Outputs and Inputs pages
6. Configuration pages

Navigation

- To navigate between menu levels use the  and  keys.
- To navigate through pages on the same level, use the  keys. Holding down these keys enables fast scrolling. This allows menu pages and settings to be scrolled through rapidly with out having to press the key multiple times.
- To return back to the Main Menu page press the **ESC** key.

Voice Message Information Page – Level 1

This page is found on menu level one and provides detailed information on a voice message while it is playing. The page is blank at all other times. It also shows a figure to denote the level of audio detected on the communication line, as well as a digital communication status indicator.

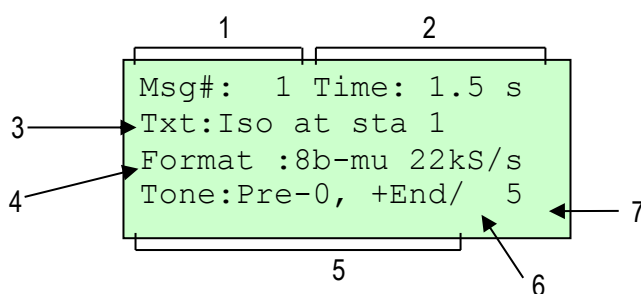

Figure 12 - Voice Message Information Page

- | | | | |
|---|--------------------------------|---|--|
| 1 | Number of last message played | 5 | Pre-tone used with message (see Table 10) |
| 2 | Message duration | 6 | Digital communication status – indicator appears as a spinning bar |
| 3 | Name of last message played | 7 | Audio level detected on lines |
| 4 | Audio format message saved as* | | |

VCA Message Bank Download Page – Level 1

This page shows the PC to VCA communication and Message Bank download status when the VCA is connected to a PC running the Voice Message Bank Editor program. The display needs to be put on this page in order to download a voice message bank. The use of this page is described in more detail in the chapter titled “Creating and Downloading Voice Messages”.

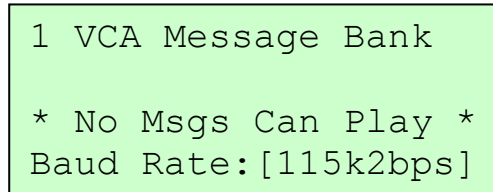

Figure 13 - Voice Message Download Page

SHORTCUT: When on this page, pressing the **ENTER** key will take you to the Message Bank Serial Baud Rate configuration page from where the RS-232 port’s baud rate can be changed.

Line Status, VAA Status and Programming Pages – Level 2 and 3

Menu level 2 shows status information for communication **LINE1** and menu level 3 shows status information for communication **LINE 2**. The Line Status Page gives an overall view of the current state of the communications line. By moving to the left or right on either of these two levels you will find current status for each VAA connected to that line. VAA address settings configuration pages can also be accessed from these menu levels.

Line Status Page

The Line Status page for LINE 1 is shown in Figure 14 below.

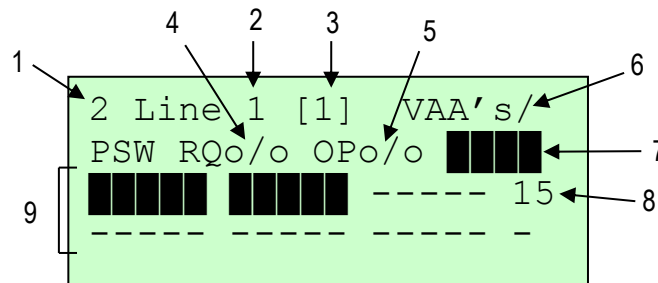



Figure 14 - Line Status Page

- | | | | |
|---|--|---|---|
| 1 | Menu level (shown on all pages except those on menu level 1) | 6 | Digital comms status – indicator appears as a spinning bar when digital communication is on |
| 2 | Line number (LINE 1 for this display) | 7 | VAA key press indication |
| 3 | Number of VAA's set to be online | 8 | VAA address being polled |
| 4 | Current state of pre-start 1 request (PSR1) digital input (o/o = open, o-o = asserted) | 9 | Representation of communication line showing VAA's online |
| 5 | Current state of pre-start 1 confirmation (PSC1) relay output (o/o = open, o-o = closed) | | |

VAA's Online and Clash Indication

The third and fourth lines of this display give a semi-graphical representation of the communications line. Each display character segment represents a VAA address. Address 1 is at the left end of the third line of the display and address 15 is at the right end. Address 16 is at the left end of the fourth line and address 31 is at the right end.

-  symbol represents a VAA that is connected to the line and communicating with the VCA.
- – character indicates that there is no VAA present at that address.
- C character indicates an address clash at that address.

Number of VAAs to be Online Value

The top line shows the number of VAA's that we expect to see online. This value should match the number of VAAs that are currently installed. This setting is found on menu level 6 and is set at the time of commissioning or whenever a VAA is added or removed from the line. More information about this setting can be found later in this chapter and in the Commissioning chapter.

Digital Communication Indicator

While the digital communication protocol is running a spinning bar will appear on the right hand end of the top display line.

Polling Address Number

While the digital communication protocol is running, the VCA does a 'round-robin' scan of every VAA address, 1 to 31. This takes approximately 7 seconds. This number shows which address is currently being scanned and will count rapidly up through the address range.

Pre-start Request Input and Confirm Output State Indication

The second line of the display shows the current state of the Pre-Start Alarm Request (PSR) digital input and the Pre-start Confirm (PSC) relay output for this line.

VAA Key Press Indication

There are four  symbols which will appear on the right hand end of the second line, one for each VAA keypad key. From left to right, these blocks indicate the CALL EXCHANGE key, CALL LOCAL key, FUNC key and SPEAK key. When a VAA key is pressed, the respective block will appear.

NOTE: If an address clash has existed for several digital round-robin scans, it will take several more scans once the clash has been rectified before the C symbol disappears from the line display.

SHORTCUT: Pressing the  key will make the display jump to the # of VAA's to be online configuration page on menu level 6.

VAA Address Setup Page

Each communication line can support up to 31 VAA units, depending on the I.S. power supply used and cable length. Utilising both VCA communication lines, the system can communicate with 62 VAAs. Each VAA unit is programmed with a unique address from 1 to 31. The configuration procedure is the same for VAA units connected to LINE 1 or LINE 2. The addressing process is carried out using the VAA unit's unique four-digit serial number engraved on the front fascia.

TIP: During installation the location and serial number of each VAA unit should be noted. A table should be created with the VAA serial number, location and chosen address. This will speed up the addressing process.

TIP: Addresses should be allocated sequentially, giving the VAA closest to the controller address 1, second closest address 2 and so forth.

VAA addressing procedure:

1. From the VCA's Main Status page, arrow down to the Line Status page for the line that the VAA unit is connected to (LINE 1 or LINE 2). Note from the menu structure diagram that the first page below the Main Status page is the Line 1 Status page. The next page down is the Line 2 Status page. To set or change the addresses of VAA units connected to Line 1 go to the Line 1 Status page. To set or change the addresses of VAA units connected to Line 2 go to the Line 2 Status page.
2. Once on the desired Line Status page, press and hold the **ESC** key and press the **ENTER** key to enter the VAA Address Setup page. This is shown in Figure 15.

NOTE: VAA address programming will time out after 10 seconds of inactivity and the display will revert back to the Line Status page. A **** time out**** message will appear on the third line when the display is about to time out. Continually pressing the **FUNC** key will reset the 10 second timer and stop the address setup display from timing out.



Figure 15 - Entering VAA Address Setup Page

3. From the Address Setup page you can cycle through all the connected VAA units by pressing the **ENTER** key. The VAA units will appear starting with the unit with the lowest serial number. VAA serial number 0100 will be used in this example. Once you have found the serial number of the VAA that you want to change the address of, press the **▶** key once. You will notice on the second line of the display the text will change from "Accept" to "SetAdr", as shown in Figure 16.

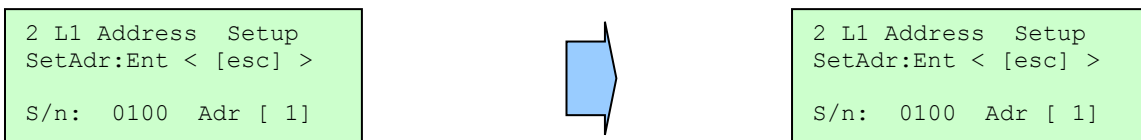

Figure 16 – Locating the VAA to address by serial number

4. Press the **▶** key again and the address will increment up by one. Continue this until you have reached the desired address value, address 4 in this example.

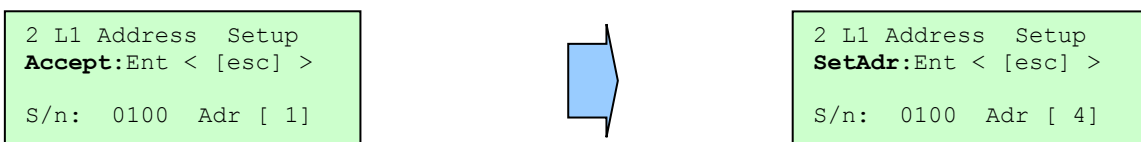

Figure 17 - Setting the VAA address value

5. To save the address press the **ENTER** key.



Figure 18 - Saving the VAA address

6. Pressing **ENTER** again will show the VAA unit with the next highest serial number. Repeat this process until all the VAA units have been correctly addressed.
7. To leave the Address Setup page at any time press the **ESC** key and you will be taken back to the Line Status page. You will now notice that the appearance of the Line Status page has changed. All the VAA units that have had their address set and are currently online will be represented by a **■** symbol. The Line 1 Status page on the right shows 10 VAA units online at addresses 1 to 10. The “-” symbol indicates that there is no VAA unit online at that particular address. A more detail description of this page and the other menu pages can be found in the VCA Operation chapter of this manual. A **C** symbol indicates an address clash. Two or more VAAs may have been programmed with the same address.

```

2 Line 1 [ 1 ] VAA's
PSW RQ o/o OPo/o
■■■■■ ■■■■■ -----
-----
    
```

Note: New VAA units will be pre-programmed to address 1 by default.

VAA Status Pages

The VAA Status pages are found on the same level as the Line Status page. They are accessed by pressing the **◀▶** keys, as shown in Figure 19.

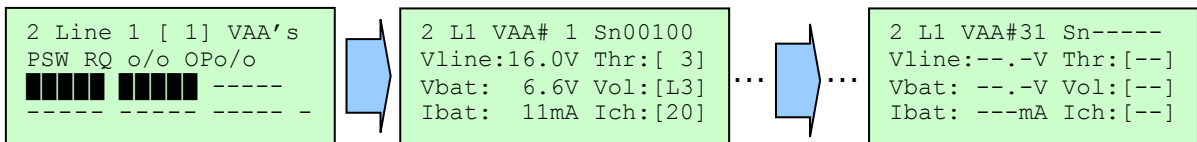

NOTE: A status page is shown for every VAA address, regardless of whether a VAA is programmed to that address

Figure 19

and communicating with the VCA. The right-most display in Figure 19 shows the status page for address 31. No parameters appear, indicating that there is no VAA is programmed to this address or this VAA is not communicating with the VCA.

The VAA Status pages show the current operational status and programmable settings for each VAA connected to the line. Figure 20 shows the status page for a VAA with serial number 00100 on Line 1, programmed to address 1.

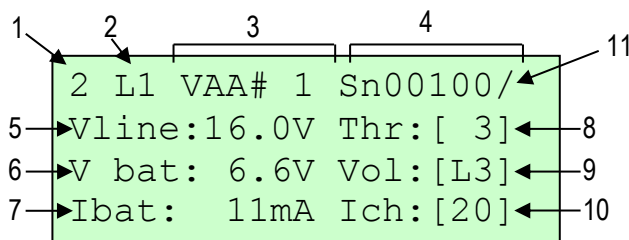

Figure 20 - VAA Status Page

1	Menu level	7	VAA battery current (positive value indicates charging current, negative current indicates current being drawn from battery)
2	Line number (Line 1 shown here)	8	Amplifier threshold setting (user programmable)
3	VAA address number (address 1 shown here)	9	Microphone gain and volume setting (user programmable)
4	VAA serial number (matches number engraved on VAA)	10	Maximum battery charging current (user programmable)
5	Line voltage at that VAA	11	Digital communication status – indicator appears as a spinning bar
6	VAA battery voltage		

VAA Operational Status Values

vline – this is the line voltage measured at the VAA. The line voltage will depend on the power supply connected to the line and the distance of the VAA from the power supply.

vbat – this is the VAA battery voltage. A fully charged battery should show a voltage of 6.6V to 6.7V. A low or almost fully depleted battery will show a voltage of 5.9V to 6.0V.

Note: The VAA batteries have an over discharge protection feature. If the battery voltage falls below 5.9V, it will shut itself off to prevent any permanent damage from occurring. The output will only turn on once the battery has received enough charge to take it above the 6.0V.

Ibat – this is the current going into/coming from the battery. The current will depend on whether the battery is charging, fully charged or if the VAA's amplifier is on (due to a PSA, voice message, etc.). A positive value denotes current used to charge the battery. While charging, this value can read between 5mA to 40mA depending on the battery charging current setting for the VAA. A negative current value indicates that current is being drawn from the battery. While sounding a pre-start alarm Ibat can read down to -200mA. When the battery is fully charged and the VAA is in "standby", Ibat will be at or near 0mA.

VAA User Programmable Settings

Threshold

The threshold setting determines what level of audio present on the communication line will be amplified by the VAA unit. The threshold can be set from 0 to 7 where 7 would provide the highest level of noise immunity. A higher threshold value is used if there is some induced noise on the communications line causing the VAA units to turn on unintentionally. As well as being a nuisance, VAAs turning on unintentionally can lead to unnecessary battery drain.

Volume and Microphone Gain

The volume and microphone gain are combined into one setting, for example “L3” where L is the gain level and 3 is the volume level. The volume setting controls the VAA unit’s output volume. The volume can be set to a value from 0 to 3 where 3 is the maximum volume. This applies to voice communication only. Pre-start alarms always sound at a fixed volume. The VAA unit’s microphone gain is set in conjunction with the volume setting. The gain can be set to “L” for low or “H” for high. The low gain setting would be appropriate for an environment with a high level of background noise. The low setting necessitates that the operator speaks close to the VAA and raise his voice. The high gain is suitable for most other low noise environments. Some simple tests will help to find an appropriate gain level.

Battery Charging Current

The battery charging current can be set to a value between 5mA and 40mA. As soon as current is drawn from a VAA battery due to a pre-start alarm, for example, the battery will want to immediately recoup any lost charge. The battery will take as much current as it has been set to take. Because the current available from the intrinsically safe power supply is limited, some planning is required when choosing a battery charging current for a particular VAA unit. If the charging currents are set too high, the VAAs closest to the power supply will take all the current they can leaving little current for the VAAs furthest away from the power supply. These VAAs may never charge fully. An example will help to illustrate this.

Example: There are 31 VAAs connected to LINE 1 and a 14VDC 1A I.S. power supply is being used. The battery charging current of all the VAAs has been set to 40mA. Assuming all the batteries are fully charged, a pre-start alarm is sounded. As soon as the pre-start alarm stops, all VAAs will try to draw 40mA from the line power supply. The first 20 so VAAs may be able to draw at or near their set charging current, leaving little current left for the last 10 VAAs.

Again, some testing will need to be conducted in order to find the optimum charging currents. Trending VAA battery voltages and currents over a period of time will help with this. However, 20mA would be a good starting point.

Setting VAA parameters:

1. Go to the VAA Status page of the VAA you wish to program. Press **ENTER** to enter the VAA Set Up page. Figure 21 shows the VAA Status page for the VAA at address 1.

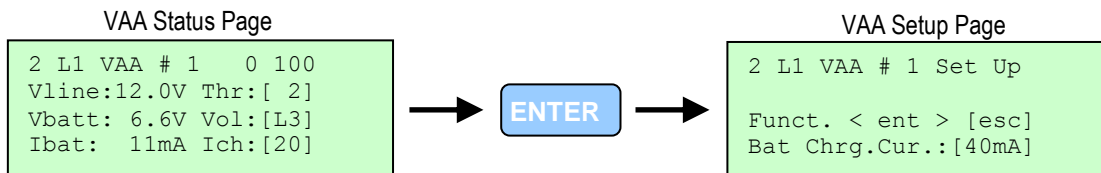
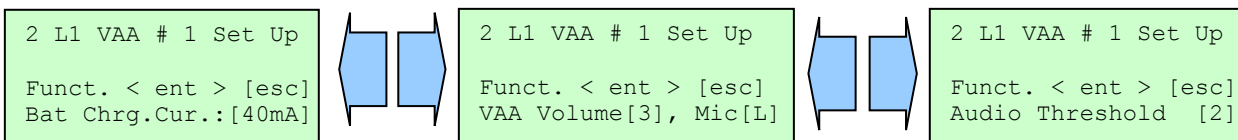

Figure 21 - Entering VAA Setup pages

2. Press the **↔** keys to scroll between the VAA settings: CHARGE CURRENT – MIC GAIN/VOLUME – THRESHOLD.

To change a setting, press the **ENTER** key and then the press the **↔** key to decrease or increase the value.



3. Press the **ENTER** key to save the new value.

Modbus Communication Status – Level 4

The Modbus page is the only menu page on menu level 4, shown in Figure 22. It displays the VCA's Modbus communication status. Modbus is the protocol used on the VCA's RS-485 port to communicate with Modbus capable control systems such as PLCs. The information given on this page includes indication of Modbus commands received and any communication errors detected by the VCA.

```

4 Modbus      Adr [ 1 ]
              Read [  ]
CRC [  ] NF [  ] Wrt. [  ]
Par [  ] FE [  ] Exc. [  ]
    
```

Figure 22 - Modbus Status Page

Adr	The Modbus slave address the VCA is set to	CRC	A solid block appears when a checksum error is detected
Read	A solid block appears when a READ command is received	Par	A solid block appears when a parity error is detected
Wrt.	A solid block appears when a WRITE command is received	NF	A solid block appears when noise is detected
Exc.	A solid block appears when an unsupported Modbus command is received	FE	A solid block appears when a framing error is detected

The configuration pages for the Modbus port can be found on menu level 6. On configuration setting allows the baud rate and parity to set. A second page allows the Modbus slave address to be changed. For more information on using Modbus, refer to the Modbus Chapter.

SHORTCUT: To change any of the Modbus communication settings, such as baud rate, parity or slave address, press the **ENTER** key to view the Modbus configuration settings.

Relay Outputs and Digital I/O – Level 5

The three pages on this menu level show the current state of the VCA's four relays, four digital outputs and fourteen digital inputs. These pages are useful for fault finding.

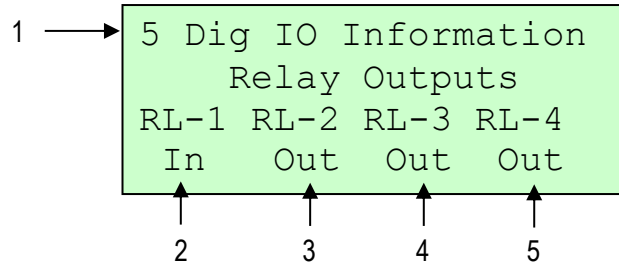

Relay Outputs Page

Figure 23 - Relay Output Status Page

1	Menu level	4	Relay 3 state
2	Relay 1 state	5	Relay 4 state
3	Relay 2 state		

In = Energised, **Out** = De-energised

Relay 1 – VCA hardware healthy. This relay should always be energised while the controller is powered. If a VCA memory fault or Message Bank processor fault occurs, this relay will de-energise.

Relay 2 – no function

Relay 3 – Pre-start alarm LINE 1 confirmed

Relay 4 – Pre-start alarm LINE 2 confirmed

Digital Output Page

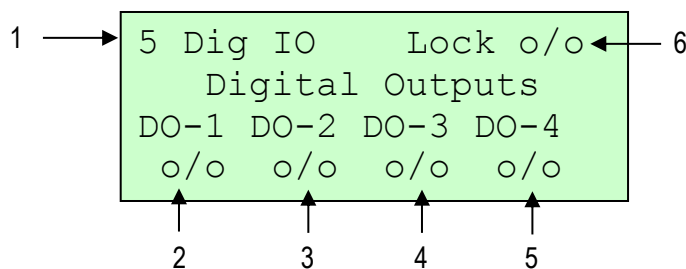

Figure 24 - Digital Outputs Status Page

1	Menu level	4	Digital output 3 state
2	Digital output 1 state	5	Digital output 4 state
3	Digital output 2 state		

o/o = unasserted (open), **o-o** = asserted (closed)

DO1 – LINE 1/LINE 2 alarm. This output is unasserted (open) when LINE 1 and LINE 2 are healthy. The output is asserted if :

- The number of VAAs the VCA can communicate with does not match the number of VAAs meant to be online. The VAAs online setting is one of the Configuration pages found on menu level 6. More information on this setting can be found later in this chapter.
- There is a VAA address clash. Check the VAA addressing.

DO2 – asserted for 5 seconds when a VAA **FUNC** key is pressed. This output can be used to trigger an external event by pressing the **FUNC** button on any VAA connected to the communication line. This output flag is also available through Modbus.

DO3 – asserted when a voice message is playing. This output provides a hardwired indication that a voice message is playing. This output flag is also available through Modbus.

DO4 – no function

Digital Inputs Page

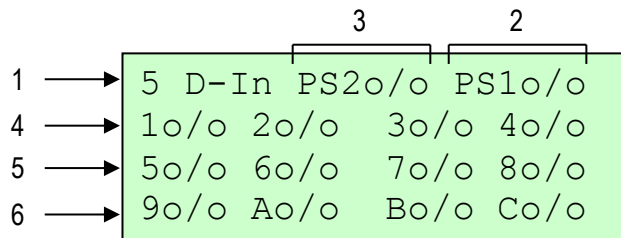

Figure 25 - Digital Inputs Status Page

- | | |
|--|--|
| <p>1 Menu level</p> <p>2 PSR1 input state – LINE 1 PSA initiate input</p> <p>3 PSR2 input state – LINE 2 PSA initiate input</p> | <p>4 Digital Inputs 1, 2, 3 and 4 state</p> <p>5 Digital Inputs 5, 6, 7 and 8 state</p> <p>6 Digital Inputs 9, 10, 11 and 12 state (A = DI10, B = DI11, C = DI12)</p> |
|--|--|
- o/o = unasserted (open), o-o = asserted (closed)

VCA Configuration – Level 6

This is the final level of the VCA menu structure. All the user configurable system and line specific settings are found on this level. Most of these are set during commissioning. Refer to Appendix A for VoiceCom system commissioning recommendations. The configuration settings in page order are shown in the table below:

Setting	Values	Description
Voice Message Mode	<ol style="list-style-type: none"> 1. [DI 1-12 + Mbus 13+] 2. [DI 1-8 msg 1-255] 3. [Modbus 1-255] 	<p>This is the voice message initiation mode setting and depends on how the system was installed.</p> <ol style="list-style-type: none"> 1. The first 12 messages are initiated directly by asserting digital inputs 1 to 12 and messages 13 to 255 are initiated via Modbus. 2. All 255 messages are initiated by setting the message address in binary via digital inputs 1 to 8 and asserting digital input 9 as the strobe. 3. All 255 messages are initiated via Modbus
Voice Message Playback Volume	[1] to [10]	This is the master voice message playback volume, where 1 is low and 10 is high. Setting the volume too high may cause the voice messages to sound distorted.
VAA Digital Coms – Turn off with Audio	[yes] or [no]	When set to yes the VoiceCom communication line digital protocol is inhibited while audio is detected on the line. The level of audio needed to turn off the digital protocol depends on the Audio Threshold setting. Set this to yes if digital noise can be heard while messages are played or during VAA to VAA communication.
VAA Digital Coms – Turn off Threshold	[0] to [7]	This is the level of audio that needs to be detected by the VCA in order for the digital communication protocol to be inhibited. Setting this to 0 means that only a small audio signal will turn off the digital protocol. Setting this to 7 will mean that a loud audio signal is required to turn off the digital protocol.
Line 1 : # of VAA's to be online	[1] to [31] or [None]	This is the number of VAA's that are connected to the LINE 1. This is the number of VAAs that the VCA should be able to communicate with. If no VAAs are connected, then this is set to None.
Line 1 ServiceFactor # VAA's offline	[0] to [5]	This is the maximum number of VAAs on LINE 1 that can fail to sound a pre-start alarm and still allow the pre-start to be successful. A successful pre-start alarm will



		close the close relay output PSC1.
Line 1 Pre-start Warning Tone	[0] to [7]	Sets the pre-start alarm tone for LINE 1. There are 8 pre-start alarm tones available.
Line 1 Pre-Start OK I Threshold	[30mA] to [180mA] in 10mA steps	This sets the minimum current that must be drawn by a VAA from its battery on LINE 1 in order for the VAA to confirm that it has sounded the pre-start alarm. This can be set to such a level as to indicate that one of the VAA's two speakers has failed. See the Pre-Start Alarm chapter for more information
Line 1 Under Voltage Alarm Level	[None]	This feature is not implemented in this version of the VCA hardware and therefore cannot be set.
Line 2 : Number of VAA's to be Online	[1] to [31] or [None]	This is the number of VAA's that are connected to the LINE 2. This is the number of VAAs that the VCA should be able to communicate with. If no VAAs are connected, then this is set to None.
Line 2 Service Factor	[0] to [5]	This is the maximum number of VAAs on LINE 2 that can fail to sound a pre-start alarm and still allow the pre-start to be successful. A successful pre-start alarm will close the close relay output PSC1.
Line 2 Pre-start Warning Tone	[0] to [7]	Sets the pre-start alarm tone for LINE 2. There are 8 pre-start alarm tones available.
Line 2 Pre-start OK Current Threshold	[30mA] to [180mA] in 10mA steps	This sets the minimum current that must be drawn by a VAA from its battery on LINE 2 in order for the VAA to confirm that it has sounded the pre-start alarm. This can be set to such a level as to indicate that one of the VAA's two speakers has failed. See the Pre-Start Alarm chapter for more information
Line 2 Under Voltage Alarm Level	[None]	This feature is not implemented in this version of the VCA hardware and therefore cannot be set.
Modbus Communication Baud Rate and Parity	[1200 Baud, Even/Odd/No Par] [2400 Baud, Even/Odd/No Par] [4800 Baud, Even/Odd/No Par] [9600 Baud, Even/Odd/No Par] [19k2 Baud, Even/Odd/No Par]	This set the communication parameters for the Modbus RS-485 port. There are 5 baud rates and the parity can be set for each baud rate.
Modbus Communication Slave Address	[1] to [31]	This sets the VCA's Modbus slave address.

Message Bank Serial Baud Rate	[28k8bps] [57k6bps] [115k2bps] [230k4bps]	This sets the baud rate of the VCA to PC connection using the RS-232 port for the downloading of Message Banks. All other communication parameters are fixed as the RS-232 port is only connected to a PC running the Voice Message Bank Editor program.
--	--	--

Changing VCA Settings

The procedure for changing a setting on menu level 6 is the same for all settings. The procedure explains how to change VCA configuration settings using the Voice Message Playback Volume setting as an example.

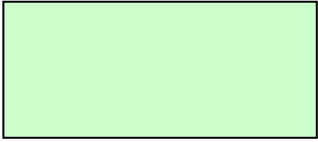
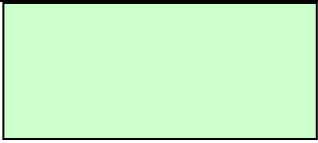
NOTE: The Key Lock input must be asserted in order for any settings to be changed.

1	Go to the setting you wish to change. For this example the Voice Message Playback Volume will be changed from 5 to 7.	<pre>6 VCA Configuration ----- Voice Message Playback Volume:[5]</pre>
2	<p>Press the ENTER key to enter the setting edit mode. The second line of the display will display the text:</p> <p style="text-align: center;"><- ent -> [esc]</p> <p>The value that appears in the [] can now be changed. Pressing the ESC key will take the display out of the setting edit mode and any changes will not be saved.</p>	
3	Use the ← → keys to change the value as required.	
4	<p>Press the ENTER key again to save the setting. The second line of the display will show:</p> <p style="text-align: center;">Saving Value ->->->-></p> <p>for a brief moment while the setting is saved.</p>	
5	Once the new value has been saved the display will go return to its normal state.	

CHAPTER 4 – VAA Operation

The VoiceCom Amplifier version A, or VAA, is the field communications unit of the VoiceCom system. It consists of two parts:

1. VAA amplifier module
2. VAA battery pack

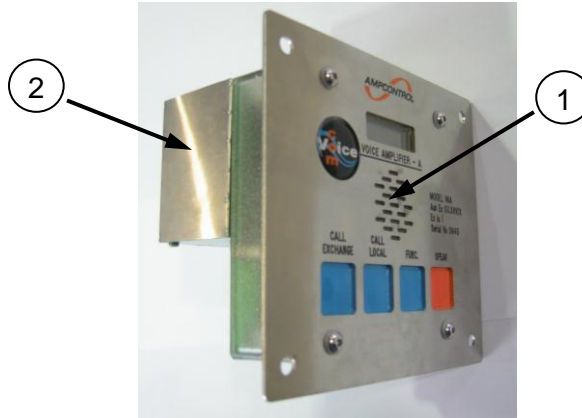

NOTE: The battery pack must be connected to the VAA amplifier module in order for the VAA to function.

Figure 26 - Amplifier Module with Battery Pack

VAA Amplifier Module

VAA Features

- | | | | |
|---|-----------------------|---|--|
| 1 | 8 character LCD | 5 | Speaker connection header for two speakers |
| 2 | Sealed microphone | 6 | Battery pack connection header |
| 3 | 4 key membrane keypad | 7 | Communication line connection header |
| 4 | VAA serial number | | |

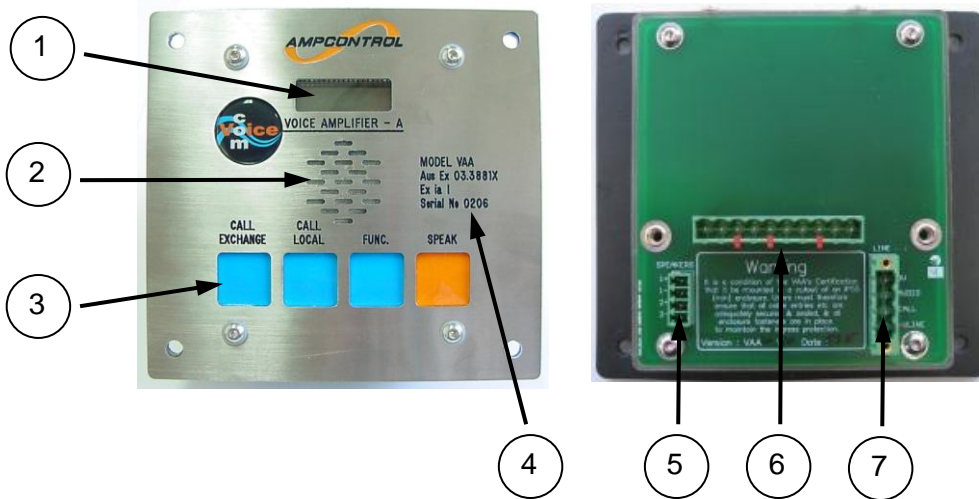
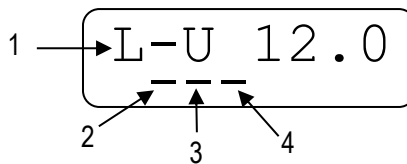

Figure 27 - VAA Amplifier Module Front and Back

The LCD



- | | |
|--|---|
| <p>1 VAA operational parameters (cycles between L-U = line volts, B-U = battery volts and B-I = battery current)</p> <p>2 Amplifier on status indicator bar</p> | <p>3 Digital comms heartbeat status indicator bar</p> <p>4 VAA data polling indicator bar</p> |
|--|---|

Display Cycle

The display shows the VAA's current operational parameters and status. The display shows line voltage (L-U), battery voltage (B-U) and battery current in milliamps (B-I). The display continuously cycles through these three operational values in the order shown in Figure 28. B-I, the battery current does appear twice in each cycle.

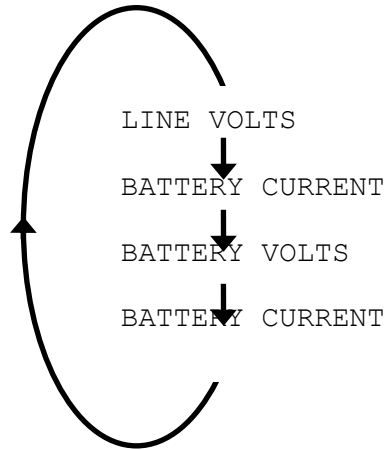

Figure 28 - VAA Display Cycle

Display Segments

The VAA display also has three horizontal segments that are very useful in fault finding. From left to right these segments are:

- **VAA amplifier on**
While the VAA's amplifier circuit is enabled, this segment will remain on. The amplifier circuit is enabled when the VAA amplifies a sound through its speakers.
- **Digital communication heartbeat**
When a VAA is connected to a healthy VoiceCom communication line with a VCA, the digital communication heartbeat segment will flash. This indicates that the VAA is sensing the digital line protocol.
- **VAA data poll**
The VCA does a 'round robin' scan of all 31 VAA addresses that takes approximately 7 seconds. Every address is polled regardless of whether a VAA is programmed to that address or not. Every time a VAA is polled this segment will flash. Viewing a VAA's status page from the VCA will cause that VAA to be polled more often.

NOTE: VAAs with version 1 firmware do not have these status segments.

Display Messages

Table 13 - VAA Display Messages

CLASH	An address clash exists. Check that all VAAs have been programmed with a unique address.
PS ---- B-I -180	When the VCA initiates a pre-start alarm PSW ---- is displayed on the VAA. The display will alternate between this message and the battery current being drawn from the battery. If the VAA does not draw more than the Pre-Start OK Current Threshold set at the VCA, this message will be displayed until the pre-start alarm stops.
PS PASS	If the VAA draws more than the Pre-Start OK Current Threshold set at the VCA then PSW PASS is displayed on the VAA for the duration of the pre-start alarm.

The Keypad

The four buttons on the VAA keypad are **SPEAK, FUNC, CALL LOCAL** and **CALL EXCHANGE**.

- **SPEAK**

Press the Speak button to communicate with another user. This voice communication will be broadcast on all VAAs connected to both communication lines. When pressed, a brief, low frequency tone (752Hz) is generated, which is used to get the attention of other users. When the SPEAK button is released, a second, brief tone (1002Hz) is heard, higher in frequency than the first to indicate that speaker has ended his broadcast. The display shows the text `SPEACH` while the button is pressed.

NOTE: The microphone has been designed to reduce the pick up of background noise. It is therefore necessary to speak as close as possible to the microphone.

- **FUNC**

The FUNC (Function) button, when pressed, causes the VCA to set a flag in the Modbus data table and asserts digital output DO2 for a period of 5 seconds. This flag and output can be used to trigger an external event, such as making the PLC play all the active system messages. A brief tone is generated when this button is pressed and is only heard locally at that VAA. The display shows the text `Func` while the button is pressed.

- **CALL LOCAL**

The Call Local button causes the VAA to generate a (848Hz) tone while being pressed. This tone is heard at that VAA and across the whole system. It can be used for signalling other users. The display shows the text `CALL LO` while the button is pressed.

- **CALL EXCHANGE**

The Call Exchange button, when pressed, causes the VAA to generate a 5 second low (200Hz) tone. If the VoiceCom system is connected to telephone pair, this tone can be used to open a voice circuit for communication with the surface. The display shows the text `CALL EH` while the button is pressed.



VAA Setup Mode

The VAA Setup Mode allows the VAA's user programmable settings to be changed locally at the VAA unit. The VCA Operation chapter describes how to program all VAA settings from the VCA. Being able to program these settings from the VAA means that a VAA can be correctly set up when it is connected to the communication line, without needing to go to the VCA. These settings are:

- VAA operating mode
- Local volume
- Threshold
- Battery charging current
- VAA address

Enter Setup Mode

A special key sequence is required to enter the VAA setup mode. Some practice may be required. To enter Setup mode follow the procedure below:

1	Press and hold the VAA's SPEAK and FUNC buttons at the same time.	
2	After a few seconds the VAA unit's LCD display will show the text SETUP F . The F will begin to flash slowly, disappearing for one second, appearing for one second, disappearing again for one second and then appearing again for one second. Press and release the FUNC key in sequence with the flashing F . Release the FUNC button when the F disappears and press the FUNC button when the F reappears. NOTE: The SPEAK button must remain pressed.	
3	If the correlation between the button presses and the flashing F is close enough, access to Setup mode is granted. The display will briefly show the VAA firmware version before displaying the first VAA setting. The SPEAK and FUNC buttons can then be released.	

NOTE: The VAA display will quit out of Setup Mode if no keys are pressed for 5 seconds and any changes will not be saved. Continually pressing the **CALL EXCHANGE** button will reset the timer and will keep the VAA in Setup Mode.

Changing the Settings

1. Press the **CALL EXCHANGE** button to scroll through the 5 settings.
2. Press the **FUNC** button to increase the value or the **CALL LOCAL** button to decrease the value.
3. **NOTE:** The Setup Mode will time out if there are no key presses for 5 seconds.
4. Press the **SPEAK** button to save the new settings. If the VAA times out of set up mode, any changes will **not** be saved.

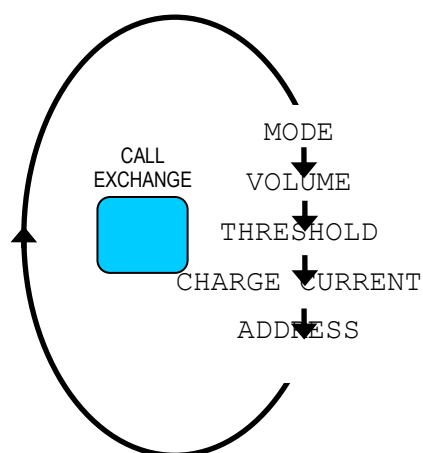

Table 14 - VAA Programmable Settings

Display	Meaning	Values	Description
MD	VAA Mode	VCA or ---	If connected to a VoiceCom system this setting should be set to VCA . If set to --- the VAA will not respond to VCA digital communication polling and will not appear online.
VOL	Volume/Gain	L0 to L3 and H0 to H3	The L/H sets the sensitivity level and the number, 0 to 3, sets the volume level. In areas of high background noise set the sensitivity to L (Low). This requires the use to speak in a louder tone, closer to the microphone. Otherwise set the sensitivity to H (High).
THRS	Threshold	0 to 7	The threshold sets the audio level on the communication required to turn the amplifier on and sound from the speakers. 0 is the lowest level, where by only a very low level of audio will turn on the amplifier. 7 is the highest level.
ICHG	Charging Current	5 to 40 (in mA)	The charging current setting is the amount of current the VAA will draw from the communication line to charge its battery. The charging current requires careful consideration as it depends on the output of the I.S. power supply used, the number of VAAs connected to the communication line and distance of the VAA from the power supply.
ADDR	VAA Address	1 to 31	Only 31 VAAs can be connected to each communication line and each VAA is given a unique address. Setting two VAAs to the same address will cause an address clash

VAA Battery Pack

Battery Pack Features:

- 6V 1.2Ah Sealed Lead Acid (SLA) battery
- Integrated battery charging circuit
- 19Vdc to 11Vdc I.S. supply input for battery charging
- 6.8V to 5.9V output to VAA
- Auto-shutoff (over discharge protection)
- 'Sleep' mode for storage

Removing and Connecting Battery Pack from Amplifier Module

Removing

1. Unscrew the two captive, allen head battery pack retaining screws using a 2.5mm hex head tool.
2. **Gently** pull the battery pack away from the amplifier module at the 10-way connector to disconnect the battery pack. The battery pack's 'securing hooks' will bend slightly.
3. Slide the securing hooks from the mounting points on the top of the amplifier module.

Connecting

1. Slide the battery pack securing hooks on to the mounting points on the top of the amplifier module so that they are clasped securely.
2. **Gently** press the battery pack connector into the header on the back of the amplifier module.
3. Screw the two captive, allen head battery pack retaining screws using a 2.5mm hex head tool.

VAA Battery States – Voltage and Charge

Table 15 - VAA Battery States

	Fully Charged	Charging	Low Charge
Battery Voltage	6.3V to 6.8V	5.9V to 6.8V	5.9V to 6.1V
Battery Current	0mA (+/-3mA)	Up to set charging current	n/a

NOTE: If the charging current setting is set to 40mA the battery will take up to 40mA, approximately. This will depend on how much current the communication line can provide.

Auto-shutoff

If the battery voltage falls below 5.9V, it will shut down its output to prevent causing permanent damage to the SLA battery cells. This will occur if there is insufficient charging current available from the communication line.

Sleep Mode

The battery pack can be put to 'sleep' to conserve battery charge and protect the battery cells from damage. Putting the battery pack to sleep forces its output to shut down. The battery pack should be put to sleep if the communication line power supply is not available i.e. when the VAA is not connected to the communication line.

To put the VAA to sleep:

1. Disconnect the VAA from the VoiceCom communication line
2. Momentarily connect a piece of wire between terminals 1 and 6 of the battery pack header, as shown in Figure 29. A piece of wire can either be inserted in the holes on top of the header or into the socket holes.
3. The VAA display will go blank when the battery has shut down.
4. Remove the wire from the header.



Figure 29 - Putting the VAA to Sleep

Waking the VAA

To 'wake' up a VAA that has shut down, connect the VAA to a VoiceCom communication line with a power supply voltage greater than 11Vdc.

- A VAA that has been put to sleep and has enough charge will wake up straight away.
- A VAA that has shut down due to low charge will have to be connected to a communication and recoup enough charge. The VAA will not wake up until the battery voltage has risen above 6.0V. This may take several hours depending on how depleted the battery charge is.

If the VAA does not wake up, the battery back may have become damaged. Refer to the Troubleshooting chapter for more information on fault finding VAAs.

Power Supplies

Only connect the VAA to an I.S. power supply with output parameters that match the VAA input parameters, as outlined in Certificate of Conformity Aus Ex 03.3881X.

CHAPTER 5 – Pre-Start Alarm Operation

There are four aspects to the pre-start alarm operation:

1. Pre-start alarm configuration
2. VCA initiating a pre-start alarm
3. VAAs sounding and confirming the pre-start alarm
4. VCA determining if pre-start alarm operation is successful

Pre-start Alarm Configuration

There are four VCA settings that affect the operation of the pre-start alarm. These are:

- # of VAA's to be online
- ServiceFactor # VAA's offline
- Pre-start Warning Tone
- Pre-Start OK I Threshold

The configuration of these settings is explained in more detail in the VCA Operation chapter and in Appendix B of this manual. If both communication lines are being used, these settings must be configured individually for each line.

Initiating a Pre-start Alarm

1. A pre-start alarm is initiated by asserting Pre-Start Request digital input, **PSR1**, for LINE 1 or **PSR2** for LINE 2 on the VCA. These inputs need to be held on for the length of pre-start alarm required. The VCA will display the text **PSW Active** on the Main Menu page. Refer to the Installation and Wiring chapter for more detailed information on using the digital inputs.

NOTE: Pre-start alarms cannot be initiated via Modbus.

2. When a pre-start alarm is initiated for a particular line, the VCA sends the pre-start alarm command down that line using the digital communication protocol. The command includes the following information:
 - Pre-start alarm tone to sound (tones 0 to 7 – depends on configuration)
 - Pre-start minimum current draw threshold (depends on configuration)
3. The pre-start alarm will sound on top of any voice messages being played or VAA to VAA communication.
4. The pre-start alarm will sound for as long as the respective digital input is held high. It sounded be sounded for at least 6 seconds, which is the time it can take for the VAAs to confirm sounding the alarm. The VCA will allow a pre-start alarm to sound for a maximum of 30 seconds. After which time the pre-start alarm will be blocked. The VCA will display the text **PSW Blocked** on the Main Menu page.
5. To sound the pre-start alarm again, the input must be removed and then reapplied. For every one second that the pre-start alarm request input is removed, three seconds of alarm sounding time become available. If the input is removed for 10 seconds, a full 30 second pre-start alarm can be sounded. This feature has been incorporated to prevent the VAA batteries from being run down by a pre-start sounding for an indefinite period if the pre-start input or the device driving the input fails.

Verifying the Pre-start Alarm Request Input

For troubleshoot purposes, the PSR1 and PSR2 digital input states can be verified by looking at the Line Status page for the desired line or the Digital Inputs page. Figure 30 below shows that the PSR1 input, the pre-start request input for LINE 1, is being asserted, as indicated by the o-o graphic.

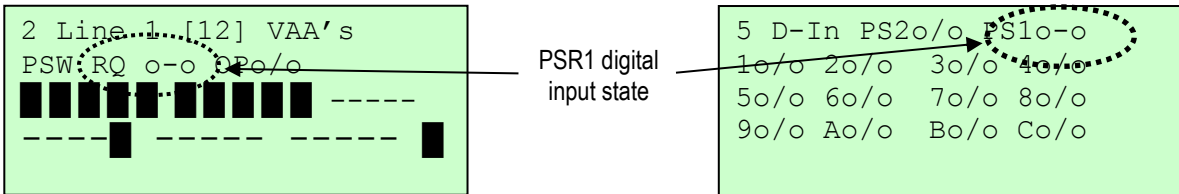

Figure 30 - Verifying the PSR Input

VAA Pre-start Alarm Sounding and Confirmation

1. All connected VAAs will receive the pre-start command and necessary parameters from the VCA.
2. The alarm tones are generated locally by each VAA, not by VCA. The tone sounded depends on the pre-start tone set for that line at the VCA.
3. While the VAA sounds the alarm, its display will alternate between showing the text **PS** ---- and the current being drawn from the battery. The "----" indicate that the alarm has not yet been confirmed for that VAA.
4. During this time, the VAA measures the current being drawn from the battery and compares this value with the current threshold level it is receiving from the VCA. A VAA will typically draw anywhere between 140mA to 180mA with two speakers connected. If one speaker fails, the current drawn will be approximately half the two speaker value. If both speakers fail, the current will only be a few mA.
 - a. If the current being drawn from the battery exceeds the current threshold level then the pre-start alarm has successfully sounded at the VAA. The VAA display will alternate between showing the text **PS PASS** and the battery current. The VAA will send this confirmation back to the VCA.
 - b. If the current being drawn from the battery is less than the current threshold level then the pre-start alarm has failed at the VAA. The VAA may have still sounded the alarm. The VAA display will alternate between showing the text **PS** ---- and the battery current. The VAA will **not** send confirmation back to the VCA.
5. The current shown on the VAA display during a pre-start will help to understand why a VAA is not confirming a pre-start alarm.

NOTE: Each pre-start alarm tone, while sounding, may draw a different amount of current. Some testing will have to be conducted to find a suitable current threshold level.

Pre-Start Alarm Confirmation

If a pre-start alarm is successful the confirmation relay output will close. **PSC1** is the pre-start confirmation output for LINE 1 and **PSC2** is the pre-start confirmation output for LINE 2. However, a pre-start alarm is successful if the correct number of VAAs sound the alarm. This depends on:

- The number of VAA supposed to be online (# of VAA's to be online setting)
- The number of VAAs that confirm sounding the pre-start alarm
- The Service Factor (ServiceFactor # VAA's offline setting)

The number of VAAs to be online setting should be set to the number of VAAs that that been installed on the respective communication line, LINE 1 or LINE 2. The Service Factor allows for some of these VAAs (up to 5) to fail to confirm sounding the pre-start alarm and still allow the confirm relay output to close.

1. The VCA receives confirmation from the VAAs.
2. The **minimum confirmations** the VCA must receive equals the number of VAAs supposed to be online minus the Service Factor (*min confirmations = # VAA's to be online – ServiceFactor # VAA's offline*).
 - a. If the number of VAA confirmations received by the VCA is greater than or equal to the minimum confirmations value, the pre-start alarm is successful. The VCA Main Menu page will display the text **PSW Healthy**. The confirm relay (PSC1 or PSC2) will close.
 - b. If the number of VAA confirmations received by the VCA is less than the minimum confirmations value, the pre-start alarm has failed. The VCA Main Menu page will display the text **PSW Active** until the pre-start request input is removed or the pre-start is blocked. The confirm relay (PSC1 or PSC2) will **not** close.

Verifying the Pre-start Alarm While Active

Verifying the pre-start alarm operation is best done from the Line Status page for the line sounding the alarm. When a pre-start alarm is active it is possible to see exactly which VAAs have given confirmation and which ones have failed. This page also shows that state of the confirm relay for that line. This process is illustrated in Table 16.

1. On the Line Status page, a **■** indicates that a VAA is online at that address.
2. When a pre-start alarm is initiated, the **■** symbol turns to an **○** for all 31 of the VAA addresses. This **○** remains on the display until the confirmations are received.
3. When the VCA receives the confirmations from all or most of the VAAs, the **○** turns to either an **x** or a **P**. The **P** indicating that that VAA has confirmed sound the alarm and the **x** indicating that it has not. This display remains while the pre-start input is asserted. Once the pre-start alarm input is de-asserted the Line Status display reverts back to showing the solid blocks representing each VAA.

1	Line Status page showing 20 VAAs on LINE 1, at addresses 1 to 20, before the pre-start is initiated.	<pre> 2 Line 1 [20] VAA's PSW RQo/o OPo/o ■ - - - - - - - - - - </pre>
2	The pre-start alarm is initiated, but no VAA confirmations have been received. Note that the request input is closed, as shown by the RQo-o graphic.	<pre> 2 Line 1 [20] VAA's PSW RQo-o OPo/o 00000 00000 00000 00000 - - - - - - - - - - </pre>
3	The confirmations have been received. 19 of the 20 VAAs have confirmed, with the VAA at address 8 indicating a failure. The confirmation relay has closed as indicated by the OPo-o graphic. <i>But one failure was detected, so why has the confirmation output closed?</i> The Service Factor was set to a value of one or greater, allowing the system to tolerate the VAA at address 8 failing.	<pre> 2 Line 1 [20] VAA's PSW RQo-o OPo-o PPPPP PXXPP PPPPP PPPPP - - - - - - - - - - </pre>

Table 16 - PSA Confirmation Process

Verifying the Pre-start Alarm Later

From the Line Status page, the outcome of the last pre-start alarm operation can be viewed for fault finding purposes.

1. Pressing the **FUNC** key will show which VAAs confirmed, however it does not explicitly show which VAAs failed.
2. Press and hold the **FUNC** key. The **■** symbol will change into either a **P** or a **-**.
3. If the **■** changes to a **P**, this indicates that that VAA confirmed sounding the last pre-start alarm. If the **■** turn to a **-**, this indicates that that VAA failed to sound the pre-start alarm correctly.

NOTE: Pre-start alarm operational data, as described above, can be read via Modbus. Refer to the Modbus chapter for more information.

Pre-start Alarm Operation Examples

Example 1 – a successful pre-start alarm

The system:

- VAAs connected: 20
- # of VAA's to be online: 20
- ServiceFactor # VAA's offline: 0

1. Figure 31 shows the Line Status page before the pre-start alarm is initiated.
2. A pre-start alarm is initiated on LINE 1 by asserting the PSR1 digital input as indicated by the **RQo-o** graphic.
3. Once all of the VAA confirmations have been received, the Line Status page will then appear shown in Figure 32. It can be seen that all 20 VAA units have confirmed as indicated by the **P**'s, each representing confirming VAA.
4. The **OPo-o** graphic indicates that the pre-start confirm relay is energised because the pre-start alarm has sounded successfully.

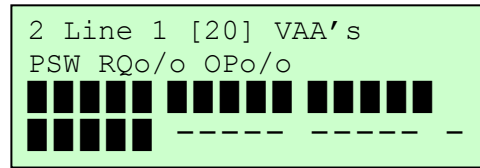

Figure 31

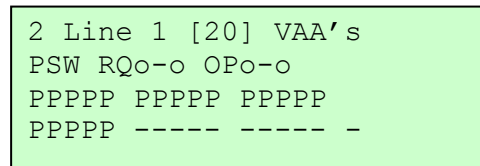

Figure 32

Example 2 – a failed pre-start alarm

The system:

- VAAs connected: 20
- # of VAA's to be online: 20
- ServiceFactor # VAA's offline: 0

1. The settings are kept the same as example 1.
2. Figure 33 shows how the Line Status page once all the confirmations have been received. Note the two **x** symbols, indicating that VAAs at addresses 7 and 20 failed to confirm the pre-start alarm.

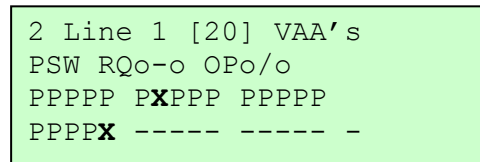

Figure 33

3. The confirmation output will **not** close, **OPo/o**, because two VAA failures have been detected. The Service Factor is set to 0; therefore the system will not tolerate any failed VAAs. Setting the Service Factor to 2 would have made this pre-start alarm operation successful.

Example 3

The system:

- VAAs connected: **20**
- # of VAA's to be online: **20**
- ServiceFactor # VAA's offline: **3**

1. For this example the Service Factor is set to 3.
2. Figure 34 shows how the Line Status page once all the confirmations have been received. Note the three **x** symbols, indicating that VAAs at addresses 7, 15 and 20 failed to confirm that they have sounded a pre-start alarm.

```

2 Line 1 [20] VAA's
PSW RQo-o OPo-o
PPPPP PXPPP PPPX
PPPPX ----- -
    
```

Figure 34

3. Because the Service Factor is set to 3, we can tolerate up to three VAA failures.
4. The **OPo-o** graphic indicates that the pre-start confirm relay is energised because the pre-start alarm has sounded successfully.
5. Once the pre-start alarm input has been removed, the Line Status page will revert back to its normal display, showing a solid block for each VAA online.
6. To view which VAAs confirmed sounding an alarm during the last pre-start, press and hold the **FUNC** key. The Line Status page is shown in Figure 35

```

2 Line 1 [20] VAA's
PSW RQo-o OPo-o
PPPPP P-PPP PPPP-
PPPPP- ----- -
    
```

Figure 35

Note that the VAAs that failed to confirm are not explicitly shown. Only the units that confirmed, as indicated by the **P**, are shown.

When the **FUNC** key is pressed, any **■** symbols that change to **-** symbols can be assumed to have failed during the last pre-start alarm.

CHAPTER 6 – Creating And Downloading Voice Messages

The VCA Controller has the capability of storing and playing up to 255 individual, pre-recorded voice messages. These messages are created in the easy steps:

1. Record and edit the voice message sound files on a PC.
2. Create the Voice Message Bank using the Ampcontrol Voice Message Bank Editor PC program provided.
3. Download the message bank into the VCA.

Recording and Editing Voice Messages

The voice messages can be recorded using a PC with a sound card or similar audio input/output hardware. A myriad of PC programs are available that can record and edit sound files. The main requirement is that program has the facility to save audio files as 16bit 44kHz WAV audio files, which most do. We have successfully used a PC program called "GoldWave", which has a comprehensive set of audio recording and editing features. GoldWave can be downloaded from on of the many internet *shareware* and *freeware* download web sites. Refer to your PC manuals for information on setting up audio hardware.

The procedure for recording and editing voice messages will vary depending on the audio editing application chosen. However, below are some tips that may help with this process:

- Decide on the voice messages required for the specific installation and produce a printed script with the text of the voice messages.
- Instead of recording and saving one message at a time, record several message at once with a pause in between each message. Many audio editors will let the user to easy cut portions of a recording and save them as individual files.
- This might seem obvious, but try to conduct the recording session in as quiet an environment as possible. Many microphones are sensitive enough to pick up noise from the air-conditioning, PC fans and disk drives.
- If possible, select a voice that is clear sounding (female voices seem to get the most attention).
- When editing try to trim as much silence from either end of the message sample as possible. This will eliminate any unnecessary pauses when messages are played.
- Maximise (amplify) the samples as much as possible without introducing distortion and compromising sound quality. A combination of audio compression and amplification can be employed to produce high volume, even sounding messages. The louder message samples are the louder they will play on the VoiceCom system.
- Always save WAV audio files at 16bit 44kHz. Most audio recording programs will allow this. The VCA Message Bank Editor has the facility to down sample files if required. Higher sampling rates produce better sounding messages. VCA Message Bank storage space permitting, voice messages should be set to the highest quality format (resolution and sampling rate) possible. The audio format setting is explained later in this chapter.

VCA Message Bank Editor

 The next step is to build the voice message bank. This is done using the VoiceCom VCA Message Bank Editor PC software provided with the VCA Controller. The VCA Message Bank Editor is a software program for Windows PCs. It allows the creation, configuration and downloading of voice message banks. A voice message bank is a single file that encapsulates all of the pre-recorded voice messages and associated parameters such as message address, audio format and pre-tone number.

Voice Message Bank Editor Installation

The VCA Message Bank Editor consists of a standalone executable (.exe) file, that can be installed anywhere in the PC's file system. When run for the first time, the program will create a settings file with the extension ".ini" in the same folder as the executable file. No other installation or configuration is required

Creating a Message Bank

Starting the Editor

1. To start the editor, double click on the VCA Message Bank Editor executable file. A title window will appear for a moment showing the software version number as the program starts up. The main editor window, as shown in Figure 36, will appear.

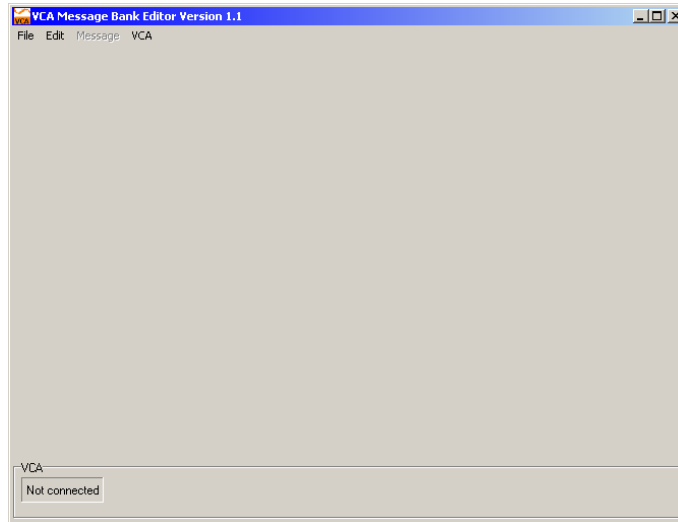

Figure 36 - Message Bank Editor Main Window

2. Like most Windows applications the editor window has a menu bar at the top left corner of the window with *File*, *Edit*, *Message* and *VCA* menus. From the *File* menu, a new message bank can be started by selecting *New* or an existing message bank can be opened by selecting *Open*.

Creating a new message bank

1. Open the File menu and select New to open a blank message bank. A message bank looks much like a table made up of six columns and 255 rows, one for each message, as shown in Figure 37. The columns are:

Number – voice message number (1 to 255)

Description – the imported WAV audio file name by default, but can be changed (14 characters max)

Format – audio format of WAV file (e.g. 16bit 44kHz)

Size – size of the WAV file (depends on the audio format selected)

Duration – length in seconds of the audio sample

Pretone – a tone that can precede and/or follow a voice message to get users' attention

Number	Description	Format	Size	Duration	Pretone
1					
2					
3					
4					
5					
6					
7					
8					
9					
10					
11					
12					
13					
14					
15					
16					
17					
18					

Figure 37 - Bank Message Bank View

2. Like many Windows operations, one process can be done more than one way. Adding an audio message to the Voice Message can be done by either:
 - a. Selecting the message number where you would like to add a message by clicking the message number once. The selected row will become highlighted. Then select *Import Sample* from the *Message* menu.
 - b. Selecting the message number where you would like to add a message by clicking the message number once. Click the right mouse button. A floating menu will appear from which you can select *Import Sample*.
3. This will open the standard Windows “Open Dialogue Box”, as shown in Figure 38. This allows you to select the desired WAV audio file to import into the Message Bank. Notice that the “Files of type:” drop down menu defaults to “WAV Files (*.WAV)”. Only WAV audio files can be imported into the message bank. Select the file and click

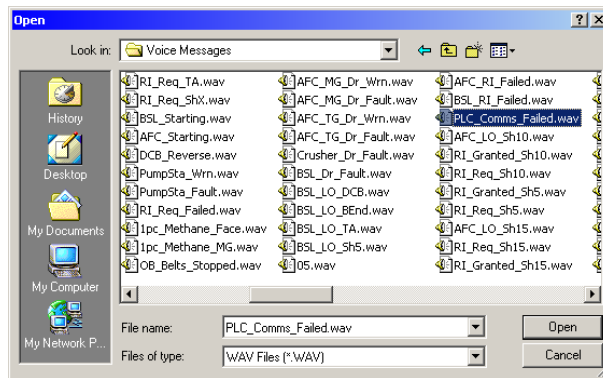

the Open button. As an example we will choose the “PLC_Comms_Failed.wav” file and import this to message 1

Figure 38 - Open Dialogue Box

4. Once imported, the voice message will appear in the message bank at the chosen message number as shown in Figure 39. There are three message attributes that can be edited: Description, Format and Pretone number. These will be explained in the next section. It may be easier to import all of the required messages first and then change the message settings.

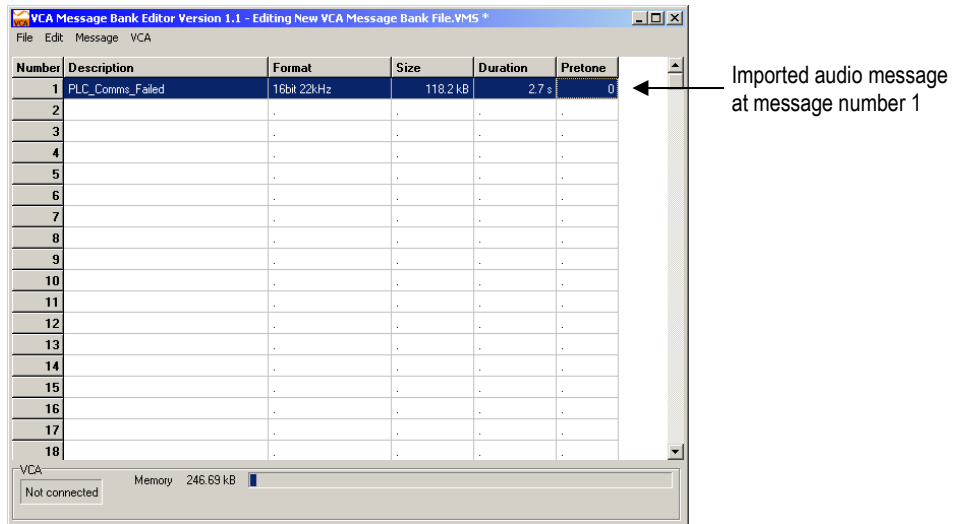

Figure 39 - Importing an audio file

- As with any program you are working with, **save frequently!** It is recommended that the Message Bank is saved as soon as it is created. Open the File menu and select Save As. Give the file a meaningful name and note where the file is saved. Message Bank files have the file extension “.vms”. The file name is displayed in the main window’s title bar, above the menus. If any changes have been made that have not been saved, the file name will have an “*” following it as shown in Figure 39.
- Repeat steps 2 through 5 again to import more messages into the message bank, and remember to save frequently to ensure changes are not lost.

TIP: Do not loose track of your Voice Message Bank files. You will need them if you ever want to add or remove messages to or from the VoiceCom system. This will save you the trouble of having to re-record and create a Message Bank from scratch. If set up properly, the same Message Bank could be reused on multiple systems.

Voice Message Settings

There are three voice message attributes that can be changed. These are:

- Voice message description
- Audio Format
- Pretone

Description

Click on a Description cell to change the message title text. When a Description cell is clicked the text becomes highlighted and a curser appears. A maximum of 14 characters can be entered. This text will appear on the VCA’s display while the message is playing.

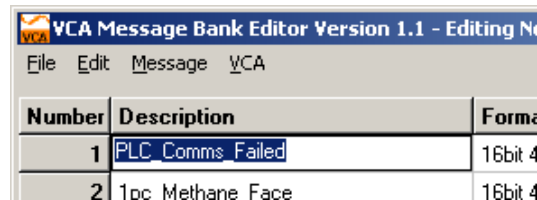

Format

Clicking the Format cell will open a drop down menu from which four audio resolutions and sample rates can be selected. The audio resolution and sample rate determines the clarity of the audio message. The highest setting, 16bit 44kHz, is comparable to Compact Disk (CD) quality audio. The lowest setting, 8bit uLaw 11kHz, is comparable to AM radio quality audio. The format chosen has a direct impact on the Voice Message Bank memory used. The higher the audio quality, the larger more memory used. The VCA Voice Message Bank memory is approximately 16MBytes. For

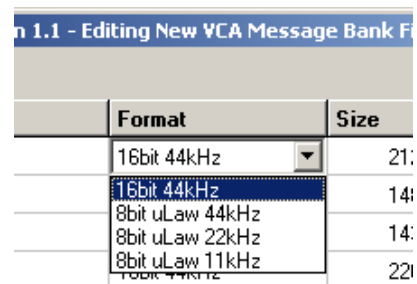

example, a 10 second audio sample recorded at 16bit 44kHz will take up approximately 860kBytes of memory. Table 17, below, shows the audio sample rates compatible with the Message Bank Editor and how they equate to the maximum total message bank length.

Table 17 - Voice Message Bank Audio Format Settings

Format (Resolution and Sample Rate)	Maximum Total Message Bank Capacity (seconds)	Relative Audio Quality
16bit 44kHz	190	CD audio ↓ AM radio
8bit μLaw 44kHz	380	
8bit μLaw 22kHz	760	
8bit μLaw 11kHz	1520	

As recommended in the previous section, voice messages should be recorded and saved at 16bit 44kHz. The Message Bank Editor allows you to lower the audio quality of the imported audio sample by changing the Format setting as necessary. Lowering the audio quality makes the audio message smaller, thus saving memory. This process only affects how the message is played by the VCA. The original audio format of an imported audio file is not lost and can be restored at any time by opening the Format menu and choosing the highest resolution and sample rate. The Format selection only affects the audio quality and hence the file size of the audio message that is downloaded into the VCA.

NOTE: If an audio message is recorded and saved as an 8bit 22kHz WAV audio file and then imported into the Message Bank, then 8bit 22kHz is the highest quality format that can be chosen.

As more messages are added to the Message Bank, you may find that you become short on memory space. At this point you may have to start experimenting with the audio formats to free up Message Bank memory.

TIP: You can test an audio message by playing it from within the Voice Message Bank Editor. Select the message number and then from the Message menu select Play. Clicking the right mouse button over the message number opens a pop up menu that also has the Play option. By playing the message, the effect of changing the audio format can be heard.

Pretone

The Pretone drop down menu allows the user to select tones that sound before (*pre-tone*) and after (*end-tone*) a voice message. A number of different pre and end-tone combinations can be chosen as shown in Table 108. Pre and end-tones are made up of three tones played in rapid succession. These tones can be used to distinguish high priority voice messages from standard messages.

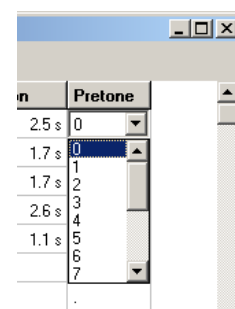

TIP: You can opt to have no pre-tone and have an end-tone (selection 7), or have a pre-tone and no end-tone (selection 14) or no pre or end-tone at all (selection 15). Using a PLC to control voice messages means that multiple messages can be linked together, for example, "Pullkey tripped at" being one message and "Cut through 1", being another message. In this instance you would not want an end-tone after the first message and a pre-tone at the beginning of the second messages so that the messages play seamlessly.

Table 108 - Pre and End-tone Combinations

Pretone Number	Pre-tone Frequencies (Hz)	End-tone Frequencies (Hz)	VCA Display
0	508, 724, 1016	1563, 1563	Pre-0, +End
1	1016, 724, 508	1563, 1563	Pre-1, +End
2	508, 508, 508	1563, 1563	Pre-2, +End
3	1250, 742, 1250	1563, 1563	Pre-3, +End
4	508, 724, 1016	1563, 1563	Pre-4, +End
5	508, 724, 1016	1563, 1563	Pre-5, +End

6	508, 724, 1016	1563, 1563	Pre-6, +End
7	No tones	1563, 1563	noPre, +End
8	508, 724, 1016	No tones	Pre-0, noEnd
9	1016, 724, 508	No tones	Pre-1, noEnd
10	508, 508, 508	No tones	Pre-2, noEnd
11	1250, 742, 1250	No tones	Pre-3, noEnd
12	508, 724, 1016	No tones	Pre-4, noEnd
13	508, 724, 1016	No tones	Pre-5, noEnd
14	508, 724, 1016	No tones	Pre-6, noEnd
15	No tones	No tones	noPre, noEnd

Other Message Menu Options

The editor has several other tools that may be useful in creating and editing a Message Bank. These can be found in the Message Menu or in the pop up menu that appears when the right mouse button is clicked. They are listed in Table 19.

Table 19 - Message Bank Editor Tools



Function	Description
Play	Plays selected message. Can be used to test the effect of changing the audio format a message.
Clear	Clears a message from selected message number.
Insert	Inserts a row into the message bank. This will shift all the following messages up by one message number for each row inserted.
Delete	Deletes a row from the message bank. This will cause all following messages to drop by one in message number for each row deleted.
Export Sample	Exporting an audio message allows you to save that message as a standalone WAV file. The message will be exported at the same audio format that it was originally imported in.

Downloading and Uploading the Message Bank

Once a Message Bank has been created or modified, the next step is to download it to the VCA. However, a Message Bank that has been loaded into a VCA can be uploaded back to a PC. This may be necessary if the original Message Bank PC file has been lost and voice messages need to be added or changed, for example.

Downloading

This is the procedure for downloading the Voice Message Bank to the VCA. This procedure assumes that a Message Bank file has been created as described in the previous section of this chapter and is ready to be downloaded.

1. Connect a serial cable between the VCA's RS-232 terminals and the serial port on a PC. Ensure the TX and RX connections are correct. It is common to accidentally reverse the connection of these signals. A ready made serial cable is available from Ampcontrol (p/n E09400).
2. Apply power to the VCA if not done so already.
3. The VCA display must be showing the "VCA Message Bank" page, shown in the figure on the right. This page is found by starting at the Main Menu Page, on menu level 1, and pressing the  key twice (or the  key once). Refer to the VCA menu map in Appendix D.

```
1 VCA Message Bank
Download? Close LOCK
Baud Rate:[115k2bps]
```

NOTE: Changing the display page while the Message Bank is downloading will abort the download. The download will have to be started again from the beginning.

4. The VCA Lock input must be asserted, as prompted by the "close LOCK" text on the VCA Message Bank shown above. To assert the Lock input, an

```
1 VCA Message Bank
* No Msgs Can Play *
Baud Rate:[115k2bps]
```

I.S. 12Vdc to 18Vdc supply must be connected between the KP3 and COM terminals of the IS EXT KEYPAD interface on the back of the VCA. The supply positive is connected to terminal KP3. The supply negative is connected to the COM terminal. Once the Lock input has been asserted the VCA Message Bank page will appear as shown in the figure on the right. Refer to the Installation and Wiring chapter of this manual for more information on wiring the Lock input.

5. Start the VoiceCom Message Bank Editor PC program and open the Message Bank file you wish to download.
6. Open the VCA menu and select the "Connection Settings..." option. This will open the Setup Communications

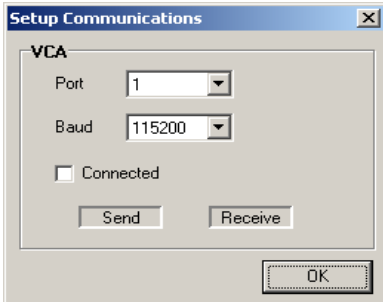

Figure 40 - Setup Communications window

window shown in Figure 40.

7. The **Port** selection sets the serial COM port on the PC used to connect to the VCA. Most PCs usually have one or two serial COM ports and they should be labelled. If the PC only has one COM port, this port is usually referred to as COM 1. Check that the Port number is set to the COM port to which the VCA is connected.

NOTE: Some newer PC laptops do not have a serial COM port. A USB to serial adaptor can be used to connect to a VCA.

8. Check that the **Baud** rate communication setting in the Setup Communications window is set to the same rate as the VCA, as shown in Figure 41. The VCA's serial baud rate is displayed on the VCA Message Bank page. By default this should be set to 115.2kbps, the maximum baud rate supported by most PC serial ports. The baud rate can also be set to 57.6k and 28.8k. Some PCs may be equipped with a high-speed serial port that supports a baud rate of 230.4kbps. Both the VCA Message Bank Editor and the VCA can be set to this higher baud rate.

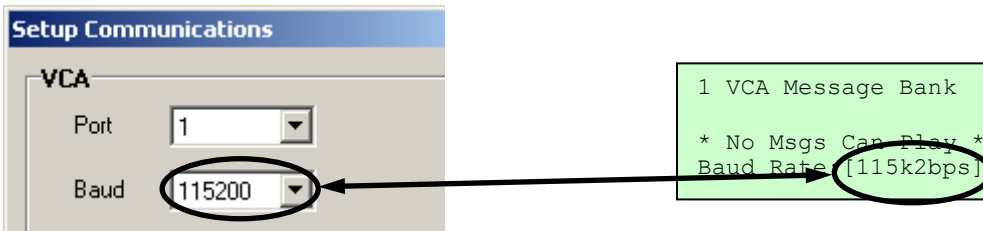

Figure 41 - Setting the Baud Rate

9. Click the **Connected** check box to establish communication between the PC and the VCA. This should cause the **Send** and **Receive** boxes to flash green, as shown in Figure 42. The VCA connection status box at the bottom left corner of the main window should also turn green and read **Connected** to indicate that the connection has been established, again shown in Figure 42. At the same time the VCA Message Bank page will display the text "Rec. Idle Command", indicating that it communicating with the PC, shown in the figure on the right.

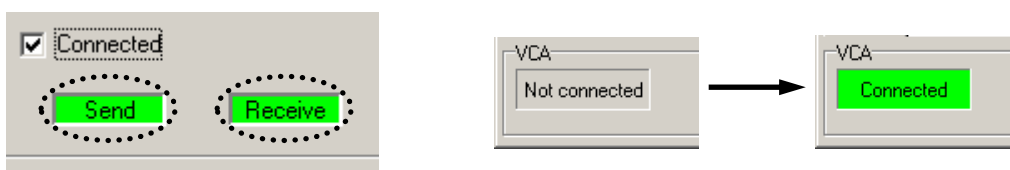
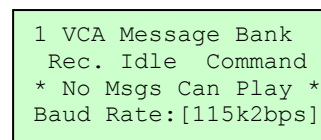

Figure 42 - PC to VCA Communication Indication

10. If you are unable to establish a connection, check that steps 1 to 9 have been followed. Check:
 - Communication cable wiring
 - VCA display is showing the VCA Message Bank page
 - Lock input is asserted
 - Serial COM port and Baud rate are set correctly
11. Having established communication, the Message Bank can now be downloaded to the VCA. To start the download, open the VCA menu and select the Download Message Bank to VCA option. The VCA connection status will change colour from green to yellow and display **Busy**. A download progress bar will also appear, shown in Figure 43.

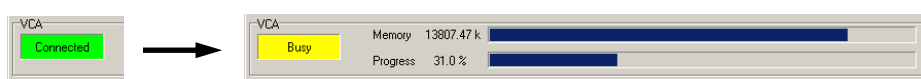

Figure 43 - Download Progress Bar

The VCA Message Bank page also displays a download percentage value as a Message Bank is downloaded. However, this value reflects the percentage of VCA Message Bank memory used, not the percentage of the Message Bank that has been downloaded, as the progress bar does. For example, take a Message Bank file that is 8Mbytes in size. Remember that the VCA Message Bank memory is 16Mbytes. This Message Bank would occupy half of the VCA's Message Bank memory. The VCA Message Bank page would display a value of about 50% just before the download completed. Do not be alarmed by this. The downloaded has completed successfully.

Uploading

The procedure for uploading a Message Bank from the VCA to a PC is almost the same as the one for downloading. Follow steps 1 to 10 as described for downloading a Message Bank. Once communication has been established follow the procedure below:

1. To start the upload, open the VCA menu and select the Upload Message Bank from VCA option. A blank Message Bank file will open and the upload will begin.
2. Once the upload has completed a pop up message will appear saying "VCA upload completed!" Click the OK button to acknowledge the message.
3. The audio messages contained in the Message Bank will appear at their set message numbers.
4. It is best to save the uploaded Message Bank straight away. Open the File menu and select the Save As option. A standard Windows dialogue box will appear. The Message Bank should be given a meaningful name and saved in a known location on the PC.

The Message Bank can now be modified as required. New audio messages can be added or existing message can be changed.

CHAPTER 7 – Troubleshooting

VoiceCom system

Symptom	Cause	Remedy
Constant digital noise on line	Faulty VAA unit	Isolate individual unit and replace
	Poor\Faulty wiring*	See notes.
	VCA has incorrect settings	Adjust VCA settings to turn digital comms off with audio
	Thresholds on VAA units to low	Adjust threshold settings on the VAA units emitting the digital noise
Fails pre-start	Service factor setting on VCA to low	Increase service factor setting on VCA
	Faulty VAA units**	Isolate individual units fault and replace
	Speakers	Replace faulty speaker\rs
iMAC or PED noise on line	Poor\Faulty wiring*	See notes.
Voice message's not playing	Incorrect settings on VCA	Check message initiation mode

*Wiring issues, any of the following can cause VoiceCom system faults:

- Spare cores on line not earthed at one point
- Shield not earthed at one point
- Spare cores not continuous
- Shield not continuous
- Shorting of any 4 voice com system wires

****Individual units**

Symptom	Cause	Remedy
Nil speaker output	Battery	Replace battery
	Faulty speaker	Replace Speaker
	VAA	Replace VAA
Nil microphone	Battery	Replace battery
	VAA	Replace VAA
Out of range current reading.	Battery	Replace battery
	VAA	Replace VAA
Out of range voltage reading.	Battery	Replace battery
	VAA	Replace VAA
Blank LCD	Battery	Replace battery
	VAA	Replace VAA
Clicking sound when speak button pushed	Battery	Replace Battery
	VAA	Replace VAA
VAA unit not showing as 'on line' at VCA	VAA setting is not in correct mode (VCA or DAC)	Adjust settings at VAA
	Battery	Replace Battery
	VAA	Replace VAA

APPENDIX A – Commissioning

The following is a guide to aid the commissioning of the VoiceCom system. The commissioning process involves the following actions:

1. VAA configuration
2. VCA line configuration
3. Pre-start alarm configuration

VAA Configuration

The following VAA parameters need to be configured:

- Address
- Volume and microphone gain
- Audio threshold
- Charging current

Address Setup

The procedure for setting VAA addresses is explained in the VCA Operation chapter, in the section titled VAA Address Setup Page. The recommended process for addressing the VAAs is:

1. Record the serial number of all VAAs connected to each communication line used, LINE 1 and LINE 2. The VAAs on each line are addressed separately. Record the serial numbers in the order in which the VAAs are physically installed on the communication and note their locations for reference.
2. Address the VAAs sequentially, as shown in Figure 44. Go to the VAA with the list of serial numbers and follow the VAA address set up procedure. Locate the VAA with the first serial number and set this to address 1.

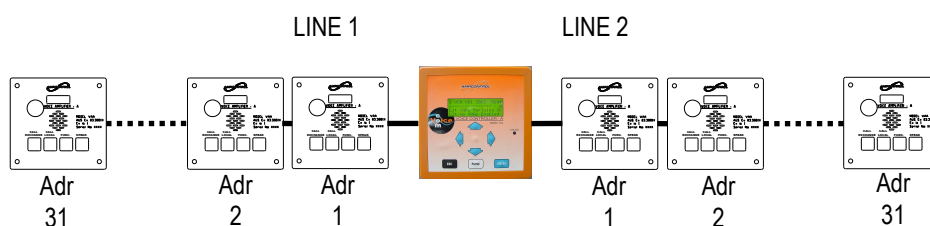

Figure 44 - VAA Addressing on Line 1 & 2

3. Repeat this until all VAAs are addressed. Keep the VAA serial number and address record up to date whenever VAAs are replaced and easily accessible.

NOTE: The location of the VCA has no effect on VAA addressing. The VCA could be connected to a point half way along the communication line, at the tripper drive for example. This is shown in Figure 45.

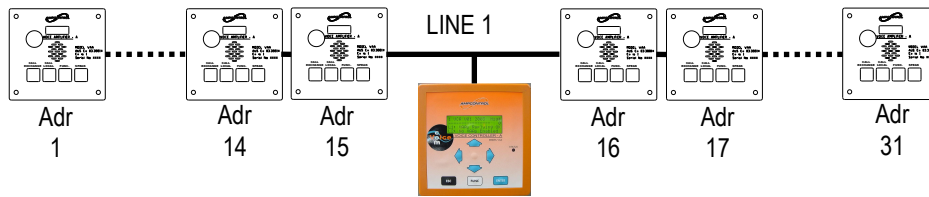
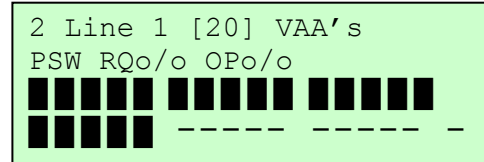

Figure 45 - VAA Addressing Single Line

4. Once all the VAAs have been correctly addressed, a block symbol for each VAA will appear on the Line Status page for that line. If two VAAs have been given the same address a C symbol will appear at the address where the clash exists. Re-check the addressing if necessary.
5. Ensure that all the VAAs are online.



Volume, Microphone Gain and Audio Threshold

The procedure for configuring these settings can be found in the VCA Operation chapter, under the section VAA User Programmable Settings. These settings can also be adjusted at the VAA. The procedure for changing settings at the VAA can be found in the VAA Operation chapter, under the section VAA Setup Mode.

The default settings should be adequate. These are:

- Volume: 3 (maximum)
Volume level 3 may be too loud for certain locations.
- Mic Gain: H (high)
The microphone gain should be set to L (low) in areas with a high level of background noise.
- Audio Threshold: 2
It is possible that noise from other electrical and electronic systems could be picked up by the VAAs. Depending on the level of this interference, the VAA may amplify the noise. If this noise is amplified for extended periods, the VAA battery charge can become depleted, causing the battery to shut down. Increasing the audio threshold will prevent the VAA from unnecessarily amplifying any noise. Note, however, if the threshold is set to high, legitimate audio from other operators may get cut off.

These settings can also be adjusted at the VAA. The procedure for changing settings at the VAA can be found in the VAA Operation chapter, under the section VAA Setup Mode.

Some testing may have to be done to find the most suitable settings for the particular installation.

Charging Current

The procedure for setting the VAA charging current is the same as setting the volume, mic gain and threshold. The default charging current is:

- Charging current: 30mA

For installations with many VAAs connected over a longer distance, this value may have to be lowered. The amount of charging current available largely depends on output of the power supply. As an example, consider the following installation:

- 500mA output power supply
- 20 VAAs
- 40mA charging current

Over a period of sustained use, possibly after several pre-start alarms, all 20 VAAs will try to draw 40mA from the power supply. The VAAs nearest the supply will take as much current as is available leaving little or no current for the last few VAAs. These last VAAs will only get an adequate amount of current once the first VAAs stop taking current from the line. In this example it is recommended that:

- The charging current settings on all VAAs are set to a low value, less than 20mA, or
- The VAAs nearest the power supply are set to a low value and the VAAs furthest away are set to 40mA. The VAAs nearest the supply will always get current they require, leaving some of the last VAAs.

VCA Line Configuration

The number of VAAs to be online setting sets how many VAAs should be connected to that line. This setting is found on menu level 6 and must be set for each line. This should match the number of VAAs that have been physically installed. If the VCA sees more or less than this value, an alarm is raised. If only LINE 1 is in use, the number of VAAs to be online for LINE 2 should be set to none.

```
6 VCA Configuration
-----
Line 1 : # off VAA's
To be online : [20]
```

Pre-start Alarm Configuration

There are three settings that must be configured before using the pre-start alarm. All these settings are found on menu level 6 for LINE 1 and LINE 2. These are:

- Service Factor
- Pre-start Warning Tone
- Pre-start OK Current Threshold

Service Factor

This parameter sets the maximum number of VAAs that can fail to sound a pre-start alarm, but allow the pre-start alarm for that line to still be successful. When the pre-start alarm is successful, the pre-start confirm (PSC1/2) relay will close.

Example: LINE 1 has 20 VAAs connected to it, and the Service Factor value for LINE 1 is set to 3. This means that up to three VAAs can fail to sound a pre-start alarm and the pre-start alarm on LINE 1 to be successful. The VCA will close its PSC 1 (for LINE 1) relay, the pre-start confirmation permissive. If four VAAs fail to send confirmation of sounding a pre-start alarm, pre-start alarm has failed to sound as intended and the PSC 1 relay will not close. The Service Factor can be set from 0 (no failed VAA units permitted) to a maximum value of 5. The procedure is the same for LINE 2.

```
6 VCA Configuration
-----
Line 1 ServiceFactor
# VAA's offline: [3]
```

Pre-Start Warning Tone

There are 8 different pre-start tones available. The same tone can be used for both LINE 1 and LINE 2, or a different tone can be selected for each line. On a long wall installation, for example, LINE 1 would run along the AFC and LINE 2 would run along the BSL and monorail. Different tones could be set for each line. A table of tone frequencies and cadences is shown in the Specifications section of this manual.

```
6 VCA Configuration
-----
Line 1 Pre-Start
Warning Tone # :[ 1]
```

Pre-Start OK Current Threshold

The Pre-Start OK Current Threshold is the minimum amount of current every VAA unit must draw from its battery while sounding a pre-start alarm. The current threshold is used to verify that the VAA has sounded the pre-start alarm. It can be set from 30mA to 180mA in 10mA steps. This parameter can be used to detect whether one or both of a VAA's two speakers have failed. While sounding a pre-start alarm the VAA will draw a certain amount of current with both speakers functioning. If one speaker fails, the current drawn will be approximately half the value drawn if both speakers were functioning. If both speakers fail, a negligible amount of current is drawn. 130mA is a suitable current threshold.

```
6 VCA Configuration
-----
Line 1 Pre-Start OK
I Threshold :[150mA]
```

The consequence of a VAA drawing less than the threshold current during a pre-start alarm is that the VAA will not confirm the pre-start alarm. The procedure is the same for LINE 2. Typical pre-start alarm battery current draw values can be found in the Specifications section of this manual.

Use the following form to note down all the commissioned VCA configuration settings and keep this form in safe place. This record will save time if the VCA is replaced.

VCA Configuration Record

Tick the box matching setting value or write setting value in the square brackets [] provided. Keep a copy of this record near the VCA.

Setting	Range	Value
Voice Message Mode	[DI 1-12 + Mbus 13+]	<input type="checkbox"/>
	[DI 1-8 msg 1-255]	<input type="checkbox"/>
	[Modbus 1-255]	<input type="checkbox"/>
Voice Message Playback Volume	[1] to [10]	[] []
VAA Digital Coms - Turn off with Audio	[yes] or [no]	[] []
VAA Digital Coms - Turn off Threshold	[0] to [7]	[] []
Line 1 : # of VAA's to be online	[1] to [31] or [None]	[] []
Line 1 ServiceFactor # VAA's offline	[0] to [5]	[] []
Line 1 Pre-start Warning Tone	[0] to [7]	[] []
Line 1 Pre-Start OK I Threshold	[30mA] to [180mA] in 10mA steps	[] []
Line 1 Under Voltage Alarm Level	[None]	[] []
Line 2 : Number of VAA's to be Online	[1] to [31] or [None]	[] []
Line 2 Service Factor	[0] to [5]	[] []
Line 2 Pre-start Warning Tone	[0] to [7]	[] []
Line 2 Pre-start OK Current Threshold	[30mA] to [180mA] in 10mA steps	[] []
Line 2 Under Voltage Alarm Level	[None]	[] []
Modbus Communication Baud Rate and Parity	[1200 Baud, Even/Odd/No Par]	1200 E <input type="checkbox"/> O <input type="checkbox"/> N <input type="checkbox"/>
	[2400 Baud, Even/Odd/No Par]	2400 E <input type="checkbox"/> O <input type="checkbox"/> N <input type="checkbox"/>
	[4800 Baud, Even/Odd/No Par]	4800 E <input type="checkbox"/> O <input type="checkbox"/> N <input type="checkbox"/>
	[4800 Baud, Even/Odd/No Par]	9600 E <input type="checkbox"/> O <input type="checkbox"/> N <input type="checkbox"/>
	[9600 Baud, Even/Odd/No Par]	19k2 E <input type="checkbox"/> O <input type="checkbox"/> N <input type="checkbox"/>
	[19k2 Baud, Even/Odd/No Par]	

VOICECOM USER MANUAL ISSUE 4

Modbus Communication Slave Address	[1] to [31]	[]
Message Bank Serial Baud Rate	[28k8bps] [57k6bps] [115k2bps] [230k4bps]	<input type="checkbox"/> <input type="checkbox"/> <input type="checkbox"/> <input type="checkbox"/>

APPENDIX B – Modbus

The VCA is equipped with an RS-485 communication port that allows point-to-point or multi-drop connection to a control or SCADA system. The protocol used by the VCA is Modbus RTU. Refer to the Installation and Wiring chapter of this manual for more information on wiring the VCA's RS-485 port.

Configuration

The following communication parameters must be set before using the RS-485 port:

- Baud rate
- Parity
- Modbus slave address

Refer to the Configuration section of the VCA Operation chapter of this manual for more information on configuring the Modbus communication parameters.

VCA Modbus Read and Write Functions

The following functions can be performed via the Modbus connection:

- Initiate voice messages
- Read VCA I/O status
- Read VCA configuration settings
- Read VCA fault alarms
- Read communication line and pre-start alarm status
- Read VAA operational parameter and setting values

Most of these functions are self explanatory from the Modbus table. However, some functions, such as initiating voice messages and reading VAA parameters require some extra explanation.

NOTE: The VCA Modbus table begins at address 0.

Initiating Voice Messages and Voice Message Control

In order to play voice messages using Modbus, the VCA must be in one of two modes:

- DI 1-12 + Mbus 13+
Only messages 13 to 255 can be initiated via Modbus. Messages 1 to 12 are initiated via digital inputs 1 to 12.
- Modbus 1 – 255
All messages 1 to 255 can be initiated via Modbus.

To initiate a voice message:

1. Write the desired message number 1 to 255 to VCA Modbus address 0 (zero).
2. The message number value will remain at that address until the message has played to completion. This allows the control device to know that a message is playing, what message it is and when it has played to completion
3. When the message has completed and no other messages are playing, the value at address 0 (zero) is 0 (zero).

Stopping a voice message:

Writing 0 (zero) to address 0 (zero) will cancel the voice message currently playing.

Message Queuing

The VCA can queue one message while another is playing. For example, while message 20 is playing, message 100 can be written to Modbus address 0 (zero). Message 20 will play to completion, immediately followed by message 100.

Joining messages together:

Joining messages together can be prudent when there are a number of common messages that can apply to a number of locations, conveyor belt stations for example. A belt station could be “tripped”, “isolation requested” or “remotely isolated”. These could be recorded as separate messages. Then a series of messages could be recorded like “at station 1”, “at station 2”, etc. These messages can be joined together – played one after the other – to form a complete message. Take a conveyor with 30 belt stations. If individual messages were recorded, 90 messages would be required: “tripped at station 1”, “isolation requested at station 1”, “belt isolated at station 1”, etc for every station. However, using the joining method would only require 33 messages to be recorded.

Reading VAA Parameters

The following VAA data can be read via Modbus:

- Line Voltage
- Battery Voltage
- Battery Current
- Charging Current Setting
- Volume Setting
- Audio Threshold Setting
- VAA Serial Number

This data has been divided into two Data Banks: Bank 0 (zero) and Bank 1. Each bank contains four bytes of data. These banks are:

Byte	Bank 0	Bank 1
1	Line Voltage	Volume
2	Battery Voltage	Threshold
3	Battery Current	VAA Serial Number High Byte
4	Charging Current	VAA Serial Number Low Byte

Data for all VAAs can be read, but only one Data Bank at any one time.

- LINE 1 VAA data is read from Modbus addresses 68 to 191 (HEX 44 to BF)
- LINE 2 VAA data is read from Modbus addresses 196 to 319 (HEX C4 to 13F)

It can be seen from the data table that there are four bytes per VAA. To set what data appears in those bytes, the desired bank number must be written to Modbus address 1, the VAA data bank select control word:

- Bank 0 – write 0 (zero) to Modbus address 1
- Bank 1 – write 1 to Modbus address 1

APPENDIX C – Application Notes

Communication Line Configurations

Longwall

- Standard VCA and PSU at DCB/CMU, L1 AFC, L2 BSL

Conveyor

- VCA at Starter, PSU anywhere, L1 only
- VCA at Tripper (midpoint), PSU anywhere L1 only
- VCA at Tripper (midpoint), PSUs (x2) anywhere L1 and L2

VAA Only (eg vehicle road, drift, etc)

- VAAs, no VCA, PSU anywhere, audio barrier

Audio Interface/Audio Barrier

- Via VCA IS Audio Interface to telephone
- Via communication line to telephone
- Via communication line to other VoiceCom system

SCADA Displays

Suggested SCADA layouts/data/trending

Voice Messages

- Initiating messages
- Joining messages together
- Using tones

Loading Voice Messages

- Load on surface/during commissioning using available PC or laptop
- Make permanent connection between VCA and PC (if networked PC located in same enclosure as VCA). Create Message Bank on other PC and save on networked file server. Have Message Bank Editor program loaded on local PC. Run Message Bank Editor and download Message Bank.
- Connect VCA via serial to Ethernet converter and load Message Bank from networked PC using “serial port replicator” s/w or h/w.

APPENDIX D – Menu Map

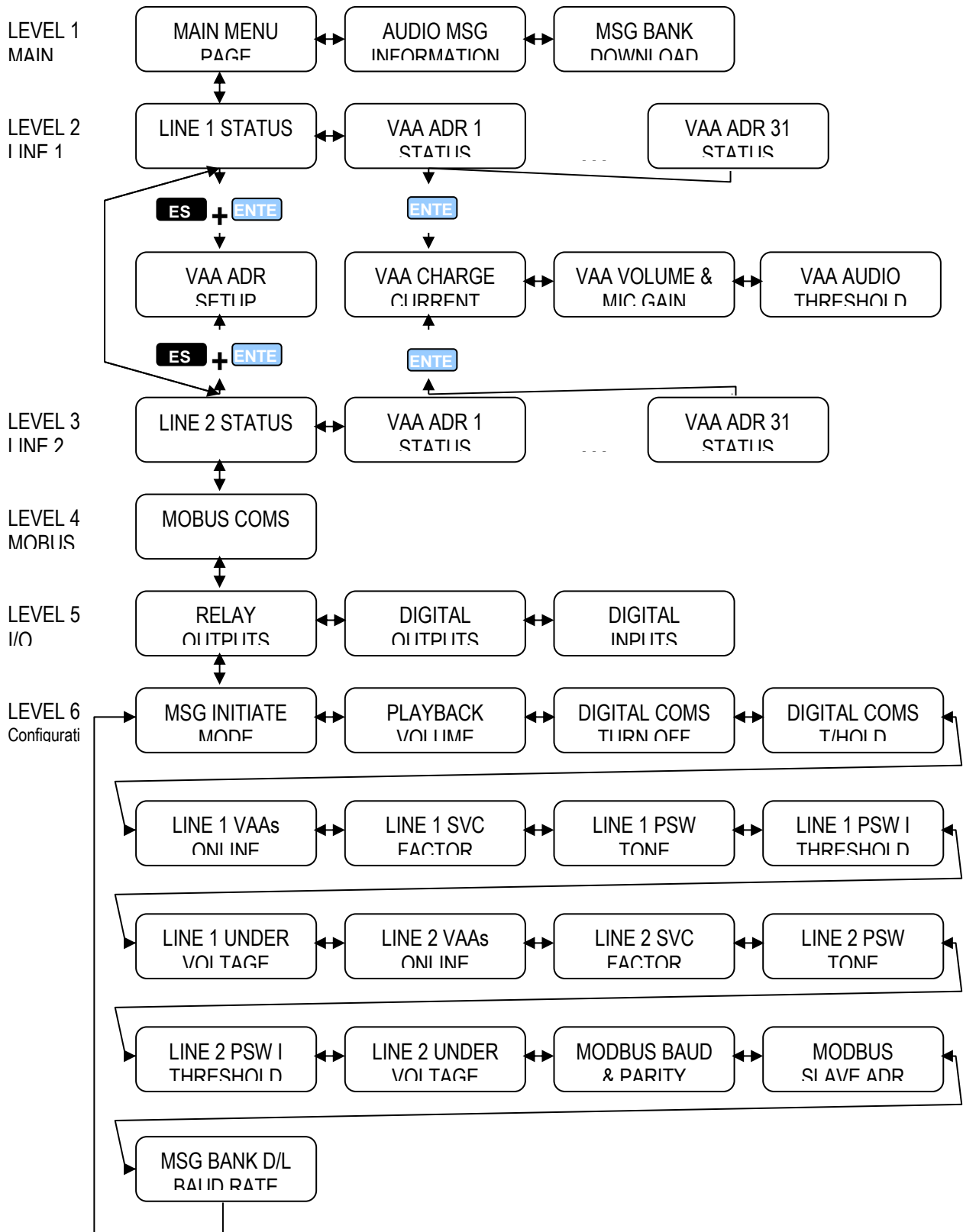

APPENDIX E– Parts List

E08588	VCA
E08985	VCA Remote Keypad
E09441	VoiceCom Audio Barrier (type NB8.5AC)
E09100	VAA Stainless Steel Speaker Enclosure with Gland Entries
E08831	VAA + Battery pack
E08584	VAA Battery Pack
E9400	RS-232 VCA to PC message bank download serial cable

APPENDIX F – Specifications

VCA

Input Supply Voltage	110VAC +/- 20%
Input Supply Frequency	50/60Hz
Input Supply Power	< 8 watts
Operating Temperature	≤ 60 degrees C
Digital I/O	
Number of Inputs	14
On-state voltage range	12-24VDC
Nominal Input Voltage	24VDC
On-state Current	< 6mA
Max Off-state Voltage	3.5V
Max Input Impedance	4.7k Ohm
Reverse Polarity Protection	Yes
Relay Outputs	
Number of Outputs	4
Maximum Output Voltage	28.5V
Output Current Rating	4mA
Relay Outputs	
- Number of Outputs	2 change over, 2 N.O.
- Relay Voltage Rating	250 VAC max
- Relay Current Rating	5A
Digital Communications	
- Communication Ports	RS-232, RS-485
- RS-232 protocols	PC to VCA for Voice Message download only
- RS-232 baud rates	28.8Kbps, 57.6Kbps, 115.2Kbps, 230.4Kbps
- RS-485 protocols	Modbus RTU
- RS-485 baud rates/parities	1200, 2400, 4800, 9600, 19.2Kbps / even, odd, none
Message Bank Memory	
- Type	Flash
- Capacity	16MB

Tones

Pre-start Alarm Tones		
- 0	Alternating 1400Hz and 1701Hz at 8 times/sec	
- 1	Alternating 1400Hz and 1701Hz at 2 times/sec	
- 2	Alternating 1344Hz and 1687Hz at 4 times/sec	
- 3	Rising from 1345Hz to 1701Hz every 0.5sec	
- 4	Rising from 1345Hz to 1701Hz every 0.25sec	
- 5	Falling from 1345Hz to 1701Hz every 0.5sec	
- 6	Rising/falling from 1345Hz to 1701Hz to 1345Hz every 1sec	
- 7	Rising/falling from 1345Hz to 1701Hz to 1345Hz every 0.5sec	
Pre/End-tone Frequencies		
Number	Pre-tone	End-Tone

VOICECOM USER MANUAL ISSUE 4

0	508, 724, 1016	1563, 1563
1	1016, 724, 508	1563, 1563
2	508, 508, 508	1563, 1563
3	1250,742, 1250	1563, 1563
4	508, 724, 1016	1563, 1563
5	508, 724, 1016	1563, 1563
6	508, 724, 1016	1563, 1563
7	No tones	1563, 1563
8	508, 724, 1016	No tones
9	1016, 724, 508	No tones
10	508, 508, 508	No tones
11	1250,742, 1250	No tones
12	508, 724, 1016	No tones
13	508, 724, 1016	No tones
14	508, 724, 1016	No tones
15	No tones	No tones
VAA Keypad Tones		
- Speak	752Hz (PRESS), 1002Hz (RELEASE)	
- Func	400Hz (momentary)	
- Call Local	848Hz (while key is pressed)	
- Call Exchange	200Hz (for 5 seconds after key is pressed)	

Message Bank Editor Requirements

APPENDIX G – I.S. Approvals

Certification of

EXPLOSION PROTECTED ELECTRICAL EQUIPMENT

Administered by: Standards Australia Quality Assurance Services

Certificate of Conformity

Certificate No: AUS Ex 03.3880X **Issue 0:** Original Issue: 2/04/2003

Date of Expiry: 2/04/2013

Certificate Holder: AMPCONTROL CSM PTY LTD
250 Macquarie Rd
WARNERS BAY NSW 2282

Electrical Equipment: Voice Control Type A: VCA

Type of Protection: [Ex ia]

Marking Code: [Ex ia] I
AUS Ex 03.3880X

Manufactured By: AMPCONTROL CSM PTY LTD
250 Macquarie Rd
WARNERS BAY NSW 2282

Issued by:



919 Londonderry Road Londonderry NSW 2753
Phone: (02) 4724 4900 Fax: (02) 4724 4999

STANDARDS AUSTRALIA

Standards Australia Quality Assurance Services Pty Limited A.B.N. 67 050 611 642

5

Page 1 of

Certification of

EXPLOSION PROTECTED ELECTRICAL EQUIPMENT

Administered by: Standards Australia Quality Assurance Services

This certificate is granted subject to the conditions as set out in Standards Australia Miscellaneous Publication MP 69 and the Procedures (Doc Q7134) of the scheme.

The electrical equipment and any acceptable variation to it specified in the schedule to this certificate and the identified documents, was found to comply with the following standards:

- AS/NZS 60079.0-2000 Electrical equipment for explosive atmospheres -- Part 0 - General requirements (incorporating Amendment 1)
- AS/NZS 60079.11-2000 Electrical equipment for explosive atmospheres – Part 11 – Intrinsic Safety ‘i’ (incorporating Amendment 1)

This certificate does not ensure compliance with electrical safety requirements and performance other than those included in the Standards listed above.

The equipment listed has successfully met the examination and test requirements as recorded in

Test Report No: TestSafe TR23611

File Reference: TestSafe 2002/021310



Signed for and on behalf of issuing authority
Laboratory Systems Manager
TestSafe Australia

Position
2/04/2003

Date of issue Ex 03.3880X

This certificate and schedule may not be reproduced except in full.

This certificate is not transferable and remains the property of Standards Australia Quality Assurance Services and must be returned in the event of its being revoked or not renewed.

Issued by:



919 Londonderry Road Londonderry NSW 2753
Phone: (02) 4724 4900 Fax: (02) 4724 4999

STANDARDS AUSTRALIA

Standards Australia Quality Assurance Services Pty Limited A.B.N. 67 050 611 632

Certification of

EXPLOSION PROTECTED ELECTRICAL EQUIPMENT

Administered by: Standards Australia Quality Assurance Services

Schedule

Certificate No: AUS Ex 03.3880X **Issue:** 0 **Date of Issue:** 2/04/2003

Certified Equipment: The Voice Control Type A or VCA is a controller for Ampcontrol's Voice Communication / Pre-start warning system, which is intended to be used on longwall faces and conveyors in underground coal mines. The VCA outputs audio signals from a pre-recorded voice message bank on to two I.S. signal lines, and controls digital communications using these lines. The digital communications allow the VCA to initiate and monitor pre-start warning tones (generated by separately certified amplifier units) as well as gather monitoring information. The VCA has various digital inputs/outputs, as well as serial ports to allow PLC & PC communications. An audio I/O port is provided to allow the VCA to connect to a separately approved I.S. Voice/data Barrier.

The VCA has a sheet metal case with a membrane keypad on the front. It is intended to be housed in a safe area. The VCA confines the I.S. critical parts to two PCB's, with their associated connectors and terminals. These two PCB's are the Line Interface Board & the IS Keypad Board. The rest of the VCA is unspecified.

The Line Interface board provides an interface to two separate voice/data lines (Line 1 & Line 2), and an interface to the Voice/Data Barrier. Fuse protected zener diodes clamp the signals to/from the main part of the VCA. Opto-couplers & infallible audio transformers provide isolation between the two I.S. lines. Signals on the I.S. side derive their power from the line, which is supplied by a separately certified I.S. power supplies - one per line.

The IS Keypad Board is intended to allow external hazardous area push buttons to be scanned by the VCA to control it's internal LCD Display/menu system. Infallible resistors and opto-couplers segregate the I.S. inputs from the rest of the VCA. The I.S side power is derived from a certified I.S supply (which may also be one of the line power supplies).

The design of the equipment is such that it offers an IP20 protection to all safety components.

Issued by:



919 Londonderry Road Londonderry NSW 2753
Phone: (02) 4724 4900 Fax: (02) 4724 4999

STANDARDS AUSTRALIA

Standards Australia Quality Assurance Services Pty Limited A.B.N. 67 050 611 642

Certification of

EXPLOSION PROTECTED ELECTRICAL EQUIPMENT

Administered by: Standards Australia Quality Assurance Services

Ex 03.3880X

Addendum to Certificate No.....

Conditions of Certification:

- 1 It is a condition of manufacture that the transformer must be subjected to a routine test where a 1500 Vrms is applied between the input and output windings of the transformer for not less than 1 minute without resulting in insulation breakdown.
- 2 It is a condition of safe use that following input parameters be taken into account while installing this apparatus:

PARAMETERS	0V, Audio, Call, -Vline, 0V and -VPS
Maximum non-IS Voltage U_m	250 V
Maximum Input Voltage U_i	19 V
Maximum Input Current I_i	3 A
Maximum Input Capacitance C_i	Negligible
Maximum Input Inductance L_i	Negligible

However, in the actual installation with the non-hazardous area circuits connected to the certified power supply, it is the output parameters of the power supply that will need to be taken into consideration.

The power supply shall only be connected with polarity as shown in the drawing VCOM-Z-036, and this connection shall be protected by a minimum of IP20 from tampering.

PARAMETERS	Audio + and Audio -
Maximum Output Voltage U_o	12.6 V
Maximum Output Current I_o	88 mA
Maximum Output Capacitance C_o	1.8 μ F
Maximum Output Inductance L_o	38 mH

- 3 It is condition of safe use that the Voice controller Type A must be installed in a safe area.
- 4 It is a condition of safe use that the IS and non-IS cabling of the VCA are kept separated.

Issued by:



919 Londonderry Road Londonderry NSW 2753
 Phone: (02) 4724 4900 Fax: (02) 4724 4999

STANDARDS AUSTRALIA

Standards Australia Quality Assurance Services Pty Limited A.B.N. 67 050 611 642

Certification of

EXPLOSION PROTECTED ELECTRICAL EQUIPMENT

Administered by: Standards Australia Quality Assurance Services

Ex 03.3880X

Addendum to Certificate No.....

Conditions of Certification continued:

- 5 The I.S. Earth terminals shall be infallibly connected to the system earth using copper conductors having a minimum cross section of 4 mm².

Drawing Schedule

Document No.	Document Title	Issue	Date
VCOM-Z-030 Sheet 1 of 4	VCA IS Line Barrier Schematic	0	21/03/2003
VCOM-Z-031 Sheet 2 of 4	VCA Line Interface Barrier Schematic	0	21/03/2003
VCOM-Z-032 Sheet 4 of 4	VCA Audio Line Interface Schematic	0	21/03/2003
VCOM-Z-033 Sheet 3 of 4	VCA Audio Barrier Schematic	0	21/03/2003
VCOM-Z-034	VCA IS Keypad Barrier Schematic	0	17/01/2003
VCOM-Z-035	VCA Line Power Mon. Schematic	0	21/03/2003
VCOM-Z-036	VCA Voice Communications Typical Connection Diagram	0	18/03/2003
VCOM-Z-038	Voice COMM Audio Transformer Details	0	21/01/2003
VCOM-Z-039 3 Sheets	VCA IS Keypad Barrier Artwork	0	21/03/2003
VCOM-Z-040 3 Sheets	VCA IS Line Barrier Artwork	0	21/03/2003
VCOM-Z-041	VCA General Arrangement	0	25/01/2003
VCOM-Z-042	VCA Internal Arrangement	0	18/03/2003

Issued by:



919 Londonderry Road Londonderry NSW 2753
 Phone: (02) 4724 4900 Fax: (02) 4724 4999

STANDARDS AUSTRALIA

Standards Australia Quality Assurance Services Pty Limited A.B.N. 67 050 611 642

5 5
 Page of

Certification of

EXPLOSION PROTECTED ELECTRICAL EQUIPMENT

Administered by: Standards Australia Quality Assurance Services

Certificate of Conformity

Certificate No: AUS Ex 03.3881X **Issue 0:** Original Issue: 2/04/2003

Date of Expiry: 2/04/2013

Certificate Holder: AMPCONTROL CSM PTY LTD
250 Macquarie Rd
WARNERS BAY NSW 2282

Electrical Equipment: Voice Amplifier Type A: VAA

Type of Protection: Ex ia

Marking Code: Ex ia I
AUS Ex 03.3881X

Manufactured By: AMPCONTROL CSM PTY LTD
250 Macquarie Rd
WARNERS BAY NSW 2282

Issued by:



919 Londonderry Road Londonderry NSW 2753
Phone: (02) 4724 4900 Fax: (02) 4724 4999

STANDARDS AUSTRALIA

Standards Australia Quality Assurance Services Pty Limited A.B.N. 63 050 611 642

Certification of

EXPLOSION PROTECTED ELECTRICAL EQUIPMENT

Administered by: Standards Australia Quality Assurance Services

This certificate is granted subject to the conditions as set out in Standards Australia Miscellaneous Publication MP 69 and the Procedures (Doc Q7134) of the scheme.

The electrical equipment and any acceptable variation to it specified in the schedule to this certificate and the identified documents, was found to comply with the following standards:

- AS/NZS 60079.0-2000 Electrical equipment for explosive atmospheres – Part 0 - General requirements (incorporating Amendment 1)
- AS/NZS 60079.11-2000 Electrical equipment for explosive atmospheres – Part 11 – Intrinsic Safety ‘i’ (incorporating Amendment 1)

This certificate does not ensure compliance with electrical safety requirements and performance other than those included in the Standards listed above.

The equipment listed has successfully met the examination and test requirements as recorded in

Test Report No: TestSafe TR23510

File Reference: TestSafe 2002/021310



Signed for and on behalf of issuing authority

Laboratory Systems Manager
TestSafe Australia

Position

2/04/2003

Date of issue

Ex 03.3881X

This certificate and schedule may not be reproduced except in full.

This certificate is not transferable and remains the property of Standards Australia Quality Assurance Services and must be returned in the event of its being revoked or not renewed.

Issued by:



919 Londonderry Road Londonderry NSW 2753
Phone: (02) 4724 4900 Fax: (02) 4724 4999

STANDARDS AUSTRALIA



Standards Australia Quality Assurance Services Pty Limited A.B.N. 67 050 611 642

Certification of

EXPLOSION PROTECTED ELECTRICAL EQUIPMENT

Administered by: Standards Australia Quality Assurance Services

Schedule

Certificate No: AUS Ex 03.3881X **Issue:** 0 **Date of Issue:** 2/04/2003

Certified Equipment: The Voice Amplifier Type A is intended to be used on longwall face and conveyors in underground coal mines. It provides intercom type voice communication between units and audible pre-start alarm tones.

The equipment has a four-button keypad, seven-segment LCD display, controlled by a low power microprocessor and is powered by a 19 V I.S. certified power supply and a 6 V rechargeable battery pack. The battery pack, including its safety components, is completely encapsulated other than the external connectors. This allows the battery pack to be removed whilst in the hazardous area.

The equipment is mounted on a stainless steel plate that shall be fixed in a cutout of an external IP55 enclosure, made of materials suitable for Group I. The stainless steel plate is mounted to the rest of the VAA assembly with a keypad membrane in between and using four allen head screws with inside and outside nylon washers. The VAA assembly has been assessed as capable of providing an ingress protection not less than IP55. The design of the equipment is such that it offers an IP20 protection to all safety components even when not fitted inside the external IP55 enclosure.

Conditions of Certification:

1. It is a condition of safe use that the following input parameters be taken into account while installing this apparatus:

INPUT PARAMETERS	GND, -V, AUDIO and Call lines (at connector JB2)
Maximum Input Voltage U_i	19 V
Maximum Input Current I_i	3 A
Maximum Input Capacitance C_i	Negligible
Maximum Input Inductance L_i	Negligible

Issued by:



919 Londonderry Road Londonderry NSW 2753
Phone: (02) 4724 4900 Fax: (02) 4724 4999

STANDARDS AUSTRALIA

Standards Australia Quality Assurance Services Pty Limited A.B.N. 67 050 611 612

Certification of

EXPLOSION PROTECTED ELECTRICAL EQUIPMENT

Administered by: Standards Australia Quality Assurance Services

Ex 03.3881X

Addendum to Certificate No.....

Conditions of Certification continued:

- 2. It is a condition of safe use that the Voice Amplifier Type A must be mounted in the cut-out of an external IP55 enclosure with fittings that do not degrade its IP rating.

Drawing Schedule

Document No.	Document Title	Issue	Date
VCM-Z-003	VAA Battery Pack	0	21/02/2003
VCM-Z-004	VAA Battery Pack - Charger	0	21/02/2003
VCM-Z-005	VAA Battery Pack Disconnecter	0	21/02/2003
VCM-Z-006	VAA Battery Regulator	0	21/02/2003
VCM-Z-007	VAA	0	06/03/2003
VCM-Z-008	VAA Core	0	06/03/2003
VCM-Z-009	VAA Digital	0	06/03/2003
VCM-Z-010	VAA Power Amp	0	06/03/2003
VCM-Z-011	VAA Line Drive	0	06/03/2003
VCM-Z-012	VAA Mic Amp	0	06/03/2003
VCM-Z-013	VAA Threshold Detector	0	06/03/2003
VCOM-Z-006	VAA Battery PCB Artwork 3 Sheets	0	24/03/2003
VCOM-Z-014	VAA core PCB Artwork 3 sheets	0	24/03/2003
VCOM-Z-015	VAA Battery Pack Mechanical Design Diagram	0	26/03/2003
VCOM-Z-016	VAA Battery Pack Mechanical Design Sections	0	26/03/2003
VCOM-Z-017	VAA Back Panel Mechanical Design Diagram	0	26/03/2003
VCOM-Z-018	VAA Mechanical Design Diagram	0	25/03/2003
VCOM-Z-019	VAA Mechanical Drawing Diagram	0	27/03/2003

Issued by:



919 Londonderry Road Londonderry NSW 2753
 Phone: (02) 4724 4900 Fax: (02) 4724 4999

STANDARDS AUSTRALIA

Standards Australia Quality Assurance Services Pty Limited A B N. 67 050 611 612