

## 1 Beginner Guide

**Attention!** Please install the suitable camera first before power on the Gimbal.

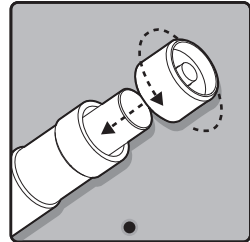

### Insert The Batteries

Remove the power switch cap, insert two 18350 batteries into the handle.

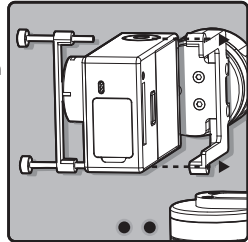

### Install The Camera

Install the GoPro camera by the special Thumb Screw. And make sure it is fixed well.

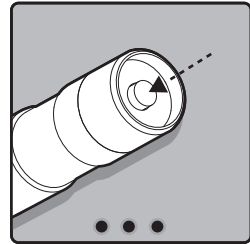

### Power On

Confirm the camera is installed well, then press the power button to turn on the Gimbal.

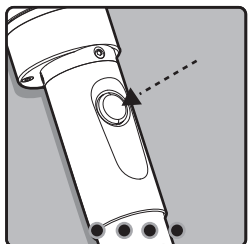

### Mode Switching

When the Gimbal is working, you can press the function button to switch among the three working modes and a special working condition freely.  
(Details of working modes please refer to the instructions of working modes)

## 4 Product Appearance Instructions

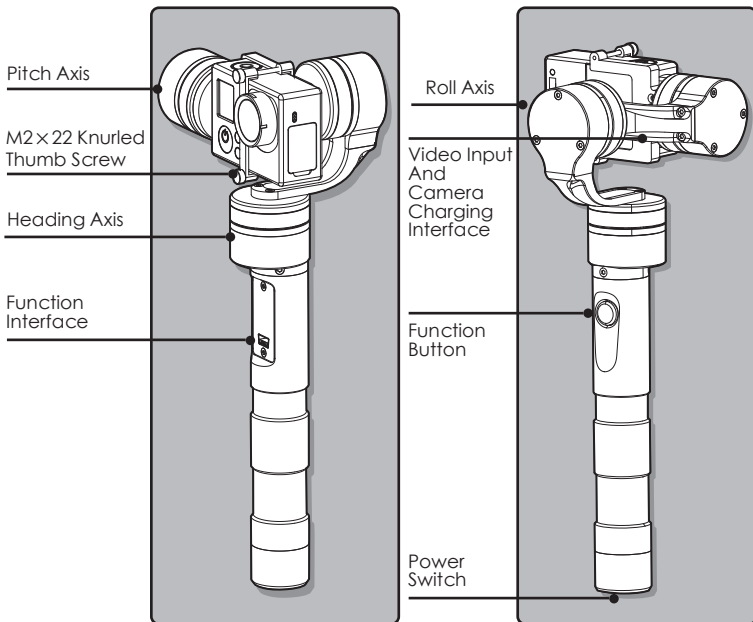

### Indicator Explanation

LED Status	Explain
Blue light flashes three times	Full power
Blue light flashes twice	Enough power
Blue light flashes once	Low power
Blue light keeps flashing	No power

The indicator flashes in red light when in working, it will prompt the Gimbal at fault.

## 2 Working Mode Instructions

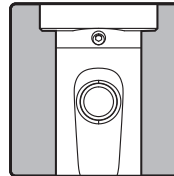

### Function Button

(Identify the working mode via switch to different status of the indicator light)  
Use for switching working modes.

### Working Mode Instructions

1. Heading Follow Mode : Camera Pitch and Roll Angles remain constant, heading follows the handheld position.
2. Heading And Pitch Follow Mode : Camera Roll Angle remains constant. Heading and Pitch follow the handheld position.
3. Heading Lock Mode: Heading, Pitch and Roll are all locked to point at one position.

**Special Working Condition (Inversion Mode):** When in any working mode, press the function button for three times in succession, the Gimbal enter into the inversion mode and switch to the Heading following mode automatically. Invert the Gimbal to capture more excited scenes easily by switching mode combination. When in inversion working condition press the function button for three times in succession to reset the Gimbal back to the original state.

Item	LED Status	Function Explanation
Single Press	Single Flashes	Heading Follow Mode
Double Press	Double Flashes	Heading And Pitch Follow Mode
Long Press For 1 Second	On Constantly	Heading, Pitch And Roll Are All Locked

## 3 Filming Skill

**Smooth And Steady Filming:** Handheld the Gimbal, keep stable for movement, keep light and steady for walking.

**How To Adjust The Pitching Angle:** Double press the function button to enter into "Heading And Pitch Follow" mode. Hold the Gimbal at the desired angle, then press the button once to reengage "Heading Follow" Mode in order to lock the angle of desired pitch.

**Selfie:** Turn the Gimbal 180° so the function interface is facing you. Then, simply adjust the angle of pitch to the desired angle by utilizing the "Heading and Pitch Follow" Mode which described above and then switch back to "Heading Follow" Mode. Once complete you can film yourself with ease.

**Flexible Use Of Inversion Mode:** Press the function button for three times in succession, the Gimbal switch to the inversion mode and help to captured low angle view more easily. If filming with moving forward at a high speed, keep the handle roughly parallel with the ground will be helpful.

## 5 Standard And Optional Accessories

### Standard Accessories

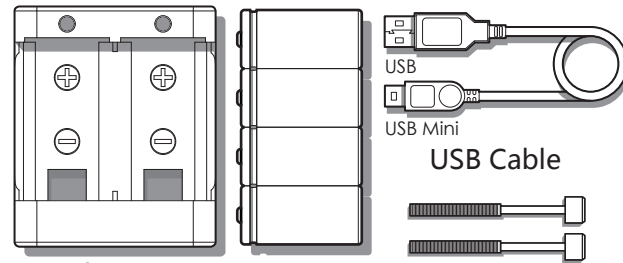

### Charger

Type: 16340/18350  
Input: DC 5V Min 800mA  
Output: DC 4.2V

### Rechargeable Battery

Type: 18350

### USB Cable

### Extension Knurled Thumb Screw

### Correct Method For Using USB Data Cable

**!** Please refer to following method to proper usage, otherwise it may cause damage to the device itself and other equipment.

**Battery Charging:** The USB Mini terminal plug to the charger, and the USB terminal insert to the power adapter for charging.

**Connect The Computer:** Remove the batteries, the USB Mini terminal insert to the function interface on the gimbal and the USB terminal insert to the USB connector then connect to the computer for firmware upgrade or parameters configuration. **(Please connect the USB cable to the computer with the USB connector, otherwise the interface of the computer will be damaged).**

Please refer to the instructions of the function interface for specific details.

### Optional Accessories

Name	Function Description
Remote Control	Ample buttons can realize the adjustment of heading & pitch angle, mode switching etc.
Runtime Extension Accessory	Extend the capacity space for battery to make the runtime longer.
Extension Bar	Spiral design of the extension bar can be perfect combination with G4 power switch; Extended length is optional, it will help to enjoy a different visual easily.
Video And Power Cable	The Gimbal can power supply for the Gopro camera, and analog video signal can output through this cable. <b>(Please connect the analog monitor for displaying)</b>

We will keep releasing more FY-G4 accessories. More details please visit our official website: [www.feiyu-tech.com](http://www.feiyu-tech.com)

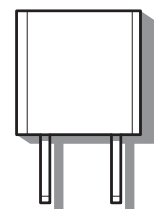

Power Adapter

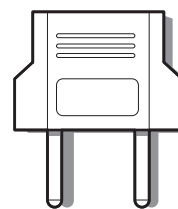

European Standard Connector

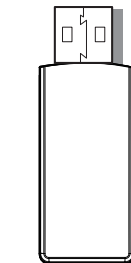

USB Connector

## 6 Function Interface Instructions

**Please Remove The Batteries Before Upgrading**

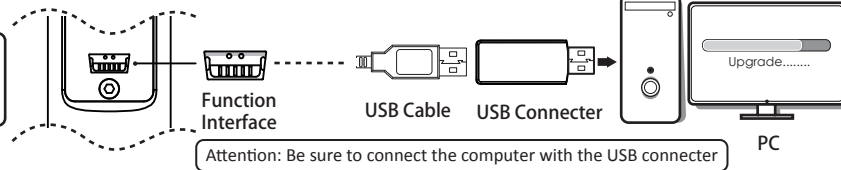

### Firmware Upgrade Instruction

Please visit the official website of Feiyu Tech: [www.feiyu-tech.com](http://www.feiyu-tech.com) to download the USB driver, firmware upgrade software and the latest firmware then unzip the RAR file. Remove the batteries and refer to the connection diagram to connect the gimbal with the computer. Please refer to the manual of update operation to upgrading, otherwise the Gimbal will be abnormal.

**Attention: Please be sure to connect the computer with the USB connector.**

### Parameters Configuration

The heading following speed can be configure through parameter setting software. User can adjust to the desired following speed mode according to the requirements of filming scene. Three modes for optional: "SLOW" mode, "NORMAL" mode, "FAST" mode. Default setting is "NORMAL" mode.

**Attention: Please be sure to connect the computer with the USB connector.**

### Gimbal Calibration

The Gimbal attitude can be calibrate through parameter setting software. User can adjust the pitch and roll in a small angle to achieve more accuracy filming scene. Please insert the batteries then refer to the connection diagram to connect the gimbal with the computer for calibration.

**Attention: Please be sure to connect the computer with the USB connector.**

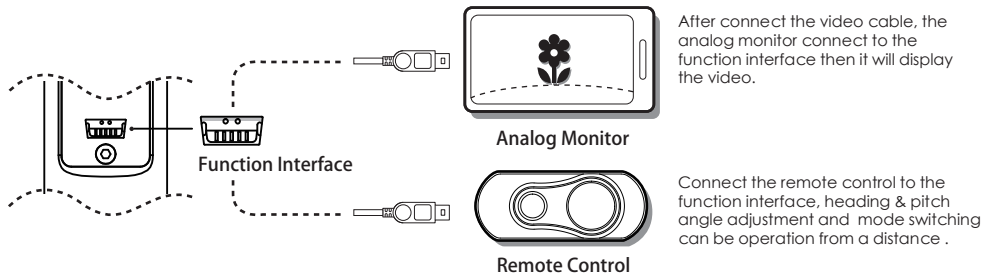

## 9 Extension Bar Instructions (Optional Item)

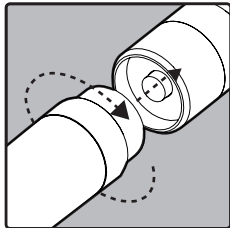

With the special designed switch, the extension bar can be added directly. Allows to shoot the distance images more easily. Special design allows for flexible extension.

370mm

φ23mm

Extension Bar Size

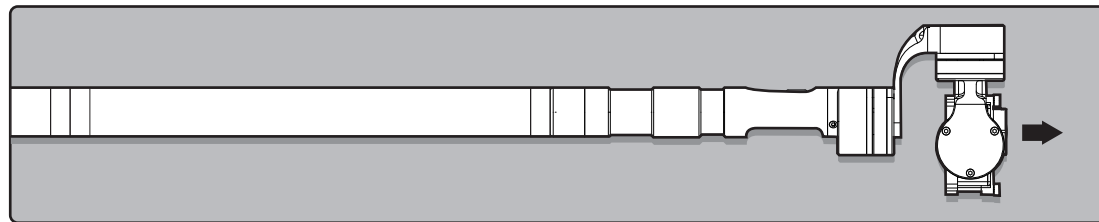

Extension Bar Diagram

If any comments or suggestions please do not hesitate to e-mail us directly: [service@feiyu-tech.com](mailto:service@feiyu-tech.com)

## 7 Video And Camera Charging Interface

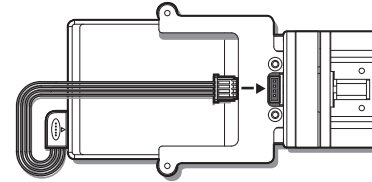

### Video And Camera Charging Interface

This interface can be output 5 voltage and analog video signal, it can power supply for GoPro camera and output the analog video signal when connect the power and video cable.

( This cable doesn't includes in the standard package, it's a optional item. )

## 8 Initialize The FY-G4 Gimbal

### Initialization Instructions

1. Install the camera properly.
2. Gimbal placed on stationary flat and keep motionless.
3. Power on the Gimbal.
4. The Gimbal is activate and it will initialize automatically. Pick up the Gimbal to work normally.

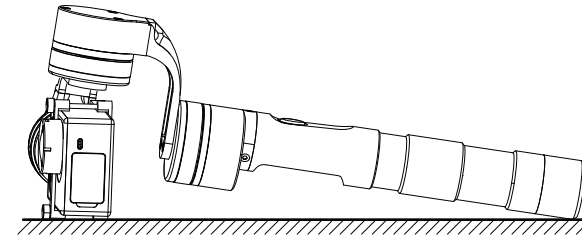

Motionless Flat Surface

### FY-G4 needs to be initialized whenever the following situations appear after power on

1. After power on, the angle of pitch is not level with the horizon line.
2. After power on, the angle of roll is not parallel with the horizon line.
3. When the gimbal is in heading lock, the angle of heading moves frequently (heading is not stationary)

## 10 Specification

Items	Min	Standard	Max	Remarks
Working Voltage	6.0V	8.4V	17.0V	
Pitch Angle	-160 (Down)	0 (Horizontal)	+160 (Up)	Handheld in horizontal
Roll Angle	-50	0 (Horizontal)	+50	
Heading Angle	-160 (Left)		+160	Handheld in vertical
Heading Angle	-50		+50	Handheld in horizontal
Pitch Following Rate	2° /Sec		75° /Sec	
Heading Following Rate	3° /Sec		150° /Sec	
Static Attitude Tracking Accuracy	0.01	0.02	0.05	Gimbal in static mode
Motion Attitude Tracking Accuracy	0.1	0.2	0.5	Motor overload<2G
Overload Current Protection		800mA		
Weight		265g		Without batteries & camera

## 11 Attention

### Disclaimer

FY-G4 handheld Gimbal is an excellent camera stabilizer, lightweight and portable. Prohibit any user for any illegal purpose. Users will be responsible for all behavior of purchase and use products.

The Gullin Feiyu Electronic Technology Co. and our associates are not responsible for any damages or liabilities caused by the use of this product.

For any unknown sources or using, we will not be any service. Feiyu Tech reserves the right to amend this manual and the terms and conditions of use the Gimbal at any time.

### Attention :

- Please correct assemble the gimbal according to the diagram .
- Please upgrading firmware and configure parameters with the standard configuration USB date cable.
- Please battery charging with the standard configuration charger.
- Please install the camera well before power on the Gimbal.



Please visit the official website of Feiyu Tech to get related information: [www.feiyu-tech.com](http://www.feiyu-tech.com)