

---

# XY-215S

---

XY Series  
Dual driver quasi-bandpass subwoofer

User's Manual



---

---

# Contents

<b>01 Introduction</b>	
Before you start.....	3
Installation guidelines.....	4
Features.....	4
<b>02 Product overview</b>	
Product overview.....	5
<b>03 System set-up</b>	
Pole-mounted full-range loudspeakers from the XY-215S.....	6
Ground stacking.....	6
Cabling and amplifier selection.....	6
Cabling.....	6
Protective DSP settings.....	6
Attachment of the CP-XYCS1 Castor Set.....	6
<b>04 Connections</b>	
Internal connection diagram.....	7
<b>05 Additional information</b>	
Dimensions.....	8
About trademarks and registered trademarks.....	9
Specifications.....	9

# Introduction

## WARNING

- This speaker system must be installed by a qualified technician as it involves such tasks as selecting a location for installation, drilling holes in walls/ceiling, wiring, and painting. Have the installer carefully follow the installation instructions.
- Certain technical skills are required to install the speaker system. Please have the product installed by a professional.
- Pioneer is not responsible for any loss or damage that results from improper installation, insufficient strength of installation materials, misuse, modification or natural disasters.

Thank you for buying this Pioneer product. Please read through these operating instructions so you will know how to operate your model properly. After you have finished reading the instructions, put them away in a safe place for future reference.

## Before you start

- Make sure to use amplifiers with rated load impedances that match the speaker impedance for the amplifiers connected to each speaker system.
- In order to prevent damage to the speaker system resulting from input overload, please observe the following precautions:
- Do not supply amplification power to the speaker system in excess of the maximum permissible input, which could damage the speaker and cause a hazard from overheating.
  - Only connect, turn ON or OFF the audio system or any one part (such as DJ player and Mixer) when the power to the amplifier is turned off. If any operations are performed while the amplifier is turned on, there is the possibility of damaging the treble frequency speaker unit.
  - When using a graphic equaliser to emphasise loud sounds in the high-frequency range, do not use excessive amplifier volume.
  - Do not try to force a low-powered amplifier to produce high sound levels as the amplifier's harmonic distortion will be increased, and you may damage the speaker.
  - Furthermore, any devices or objects easily affected by magnetism (floppy disks, magnetic cards, magnetic tape etc.) should be kept well away from the speakers.

## Caution: installation

- Ensure that the floor or stage surface can withstand the weight of the system.
- The installation technician must follow professional installation techniques to protect the speaker system against falling.
- When installing the speakers, make sure that the wall/ceiling is strong enough to support the speakers.
- Improper installation of the speakers could cause them to fall and cause damage or injuries to persons nearby.
- Do not attempt to stack devices together for use other than specified systems. Such devices may become unstable and tip over or fall, leading to injury. Make sure to secure each device in place using the specified fixing hardware or other hardware to prevent them from tipping over or falling when stacking devices together. Pioneer shall accept no liability for damage or injury caused by accidents resulting from Pioneer products tipping over or falling due to them being insufficiently secured.
- Switch off and unplug your power amplifier and consult the instructions when connecting up components. Make sure you use the correct connecting cables.
- Keep magnetic objects such as screwdrivers or steel parts away from the tweeter and woofer speakers. Since the speakers use strong magnets, the objects may be attracted, causing injury or damaging the diaphragm.
- Do not install the speaker system in areas exposed to direct sunlight or near heating appliances. Such conditions may result in shrinkage of the wood materials and finish, leading to deformation of the enclosure, discolouration, or damage to the speakers.  
Conditions considered unpleasant by humans are detrimental to speakers as well. Providing a comfortable environment for the speakers will assist them in demonstrating their best performance. Please maintain the usage environment as follows:  
Temperature: 15 °C to 25 °C (59 °F to 77 °F)  
Relative Humidity: 35 % to 65 % (winter)  
40 % to 70 % (summer)
- Do not store speakers at temperatures outside of the rated temperature range as doing so may cause the speaker to drop in performance or become damaged.  
Storage temperature range: -20 °C to +55 °C (-4 °F to +131 °F)
- Do not use the product in locations subject to extreme fluctuations in temperature. Doing so could cause the product to malfunction.
- When using room air-conditioners or stoves to rapidly cool or heat room spaces, take precautions to avoid excessive dehumidification.
- Avoid placing the speaker near areas such as windows, as outside air can cause condensation to occur within the speaker.
- This speaker system is designed for indoor use only. To avoid electric shock hazard, do not place them outside, or in an overly humid area.

## Caution: in use

- Do not use the speaker to output distorted sound for long periods of times. This can result in a fire hazard.
- Please also remember that vibrations from subwoofer systems can shake other loudspeakers out of place, which may present a toppling hazard.
- Do not attempt to use the product with the XY-215S grille detached as doing so could result in damage to the product. Consult a qualified professional for assistance with removing the grille for maintenance purposes.

## For Europe



If you want to dispose of this product, do not mix it with general household waste. There is a separate collection system for used electronic products in accordance with legislation that requires proper treatment, recovery and recycling.

Private households in the member states of the EU, in Switzerland and Norway may return their used electronic products free of charge to designated collection facilities or to a retailer (if you purchase a similar new one).

For countries not mentioned above, please contact your local authorities for the correct method of disposal.

By doing so you will ensure that your discarded product undergoes the necessary treatment, recovery and recycling and thus prevent potential negative effects on the environment and human health.

K058b\_A1\_Engb

## The Safety of Your Ears is in Your Hands

Get the most out of your equipment by playing it at a safe level – a level that lets the sound come through clearly without annoying blaring or distortion and, most importantly, without affecting your sensitive hearing. Sound can be deceiving. Over time, your hearing “comfort level” adapts to higher volumes of sound, so what sounds “normal” can actually be loud and harmful to your hearing. Guard against this by setting your equipment at a safe level BEFORE your hearing adapts.

### ESTABLISH A SAFE LEVEL:

- Set your volume control at a low setting.
- Slowly increase the sound until you can hear it comfortably and clearly, without distortion.
- Once you have established a comfortable sound level, set the dial and leave it there.

### BE SURE TO OBSERVE THE FOLLOWING GUIDELINES:

- Do not turn up the volume so high that you can't hear what's around you.
- Use caution or temporarily discontinue use in potentially hazardous situations.
- Do not use headphones while operating a motorised vehicle; the use of headphones may create a traffic hazard and is illegal in many areas.

S001a\_A1\_Engb

---

---

## Installation guidelines

### WARNING

- This speaker system must be installed by a qualified technician as it involves such tasks as selecting a location for installation, drilling holes in walls/ceiling, wiring, and painting. Have the installer carefully follow the installation instructions.
- Certain technical skills are required to install the speaker system. Please have the product installed by a professional.
- Pioneer is not responsible for any loss or damage that results from improper installation, insufficient strength of installation materials, misuse, modification or natural disasters.

A pole mount can be attached to the XY-215S. The pole mount can be attached by inserting and screwing it into the holes.

### WARNING

- Ensure that the floor or stage surface in question can withstand the weight of the system. Consult a qualified professional for advice if the strength of the surface is unknown.
- Check to make sure that any mounting hardware used is enough to support the system, whether using special hardware designed for the system or commercially available hardware. Make sure to read the Introduction section in this manual and the instruction manual for the mounting hardware thoroughly before proceeding. Be careful not to place any devices or other equipment on top of the system as such devices could fall, causing severe injury.
- Make sure to install the system in a stable location if using a pole for mounting.
- After installation, you must confirm that the speakers are safely installed. You must also periodically check them to make sure that they are still safe.
- Make sure to use mounting hardware of sufficient strength to secure the speaker in place when using non-designated hardware. The speaker could fall, causing accidents, if not properly secured.
- When this product is placed in an elevated place such as on a stage, a speaker may be moved by vibrations and fall to the floor, causing an injury or accident. Take measures to prevent a speaker from sliding off a stage, etc.
- Ensure that the floor or stage surface can withstand the weight of the system.
- Wherever possible, avoid high stacks and use ratchet straps to secure loudspeakers together. Please also remember that vibrations from subwoofer systems can shake other loudspeakers out of place, which may present a toppling hazard. The use of ratchet straps and non-slip material is recommended to prevent this.

---

---

## Features

- A quasi-bandpass subwoofer with two 15 inch LF drivers.
- High-response deep bass as low as 42 Hz is delivered to reproduce a tight and punchy kick.
- Two drivers efficiently generate air vibration to boost radiation efficiency.
- NL4 INPUT and LINK OUT connections as standard.
- 2 × pole mounts for quick set-up with Pioneer XY-81 and Pioneer XY-122.
- Robust enclosure made from premium multi-laminate birch plywood.

---

---

# Product overview

---

---

## Product overview

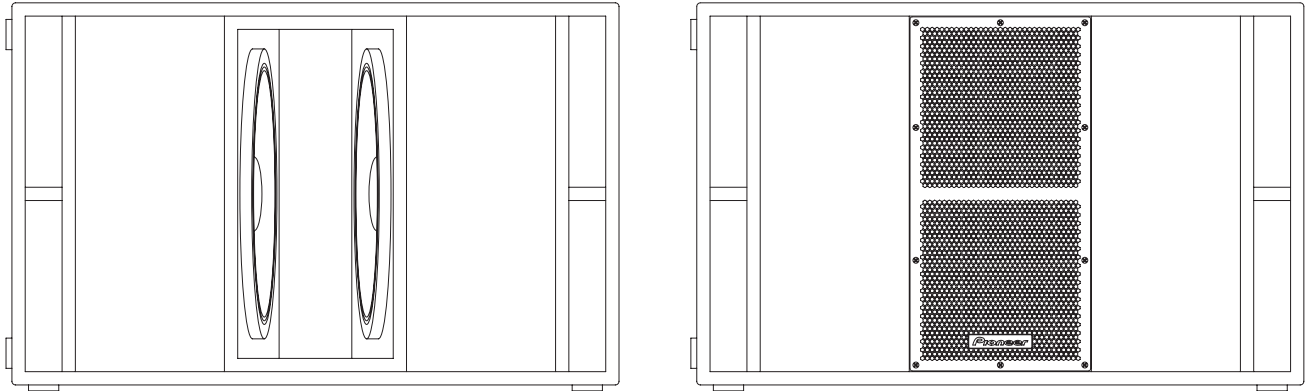

The XY-215S is a compact, powerful subwoofer product designed for a wide variety of sound reinforcement applications where compact size and weight are more critical than low frequency extension. It features a pair of high-power 15 inch (381 mm) ceramic LF drive unit in a quasi-bandpass enclosure, resulting in a response which is swift and punchy, whilst still retaining usable low frequency extension.

The XY-215S is suited to a wide variety of professional audio applications, from corporate and theater use through to small-medium scale front of house or nightclub use.

No programmed EQ is required for correct operation. For normal usage, active high and low pass filters are required. This is a lot of flexibility in the choice of crossover points, depending on programme material and user taste.

➔ For details, see *Protective DSP settings* (p.6).

The XY-215S is fitted with two Neutrik SpeakON™ NL4MP connectors. Weather protection and specific connectors can also be supplied as required.

---

---

# System set-up

## WARNING

- Loudspeaker systems are potentially dangerous objects if used incorrectly. Please ensure that you read this section fully, and contact your local dealer should you be in any doubt over correct operation procedures.
- Professional loudspeaker systems are capable of producing damage-inducing sound pressure levels, and hence care should be taken when setting your system up, particularly when it comes to loudspeaker placement within a venue. Damage to the ear can result from levels above 90 dB under prolonged exposure.

---

---

## Pole-mounted full-range loudspeakers from the XY-215S

The XY-215S can support other loudspeakers using an M20 threaded pole adapter. When mounting in this way, please consider the following:

- Ensure the adapter is screwed in tightly, your stand height is locked off and the system is stable.
- Do not stack a second loudspeaker on top of the stand-mounted one.
- Ensure cables are run so as to leave enough slack to enable neat wiring, and thus reduce the risk of the speaker being pulled over. Loose cables should be covered or taped down wherever possible to reduce trip hazards.

---

---

## Ground stacking

- Ensure that the floor or stage surface can withstand the weight of the system.
- Wherever possible, avoid high stacks and use ratchet straps to secure loudspeakers together. Please also remember that vibrations from subwoofer systems can shake other loudspeakers out of place, which may present a toppling hazard. The use of ratchet straps and non-slip material is recommended to prevent this.

---

---

## Cabling and amplifier selection

The XY-215S is designed to be used with professional power amplifiers providing the following power outputs:

- 1600 W/channel into 4  $\Omega$

## NOTE

A small power amplifier working too hard is more likely to damage a loudspeaker than a large power amplifier working within its operating range.

It is good practice to use an amplifier equal to the programme power rating of the loudspeaker — so as to retain sufficient headroom and good dynamic range. Care should be taken during operation to avoid amplifier clipping — as this can cause serious damage to your loudspeakers. If in doubt, please contact your dealer who will be happy to assist you in correct amplifier choice and setup.

---

---

## Cabling

The XY-215S is supplied as standard with Neutrik SpeakON™ NL4 connectors, wired pin 1+/-1-. It is recommended that the resistance of your cable be less than one tenth of the nominal system impedance. Given below are the recommended maximum cable lengths for different cross-sections and impedances.

Conductor cross sectional area	Maximum recommended cable length		
	4 $\Omega$	8 $\Omega$	16 $\Omega$
1.0 mm <sup>2</sup>	11 m	22 m	44 m
1.5 mm <sup>2</sup>	17 m	34 m	68 m
2.0 mm <sup>2</sup>	22 m	44 m	88 m
2.5 mm <sup>2</sup>	29 m	58 m	116 m
4.0 mm <sup>2</sup>	44 m	88 m	176 m
6.0 mm <sup>2</sup>	66 m	132 m	264 m

- Pins 2+/-2- on the Neutrik SpeakON™ connectors are wired together to allow link-through with 4-core cables.

---

---

## Protective DSP settings

The XY-215S requires at the minimum an active low pass filter to function correctly. The settings below are given as a starting point — as the user you are given maximum flexibility to adjust for your taste. To protect the drive unit, it is also advisable to apply a high pass filter to the system to protect the XY-215S drive unit from over-excitation from frequencies it cannot reproduce.

The higher you raise the cut-off frequency on a high pass filter for an XY-215S, the more headroom and overall sound pressure level output there is available. For most medium-to-high level applications, we would recommend a minimum of a 40 Hz high pass filter with a 24 dB/octave slope to sufficiently protect the loudspeaker. For higher SPL applications, we would recommend raising this cut-off even higher. We would stress that the higher the cut-off frequency, the safer the loudspeaker will be.

High Pass Filter:	40 Hz, 24 dB/Octave Linkwitz-Riley
Low Pass Filter:	125 Hz maximum, 24 dB/Octave Linkwitz-Riley

---

---

## Attachment of the CP-XYCS1 Castor Set

Attach the dedicated castors to the four mounting holes on the rear.

## NOTE

We will not be liable if you use any castors other than the dedicated ones.

# Connections

- The INPUT and LINK connectors used are Neutrik NL4 SpeakON™ connectors.
- Refer to the internal connection diagram and make the appropriate connections as shown.

XY-215S  
Rear view

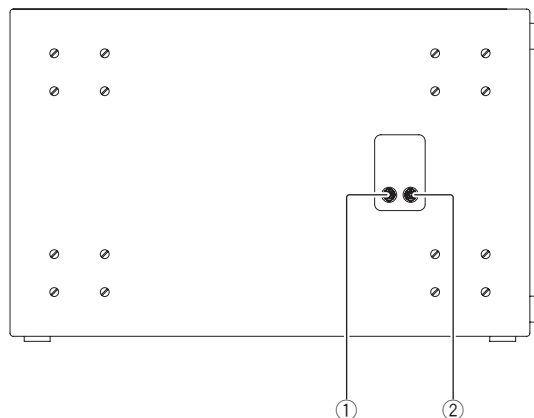

① **INPUT** connector

② **LINK** connector

Neutrik  
NL 4MP Connector

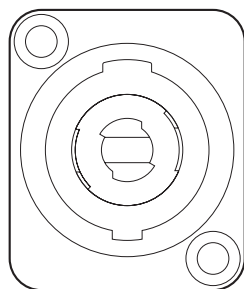

## Internal connection diagram

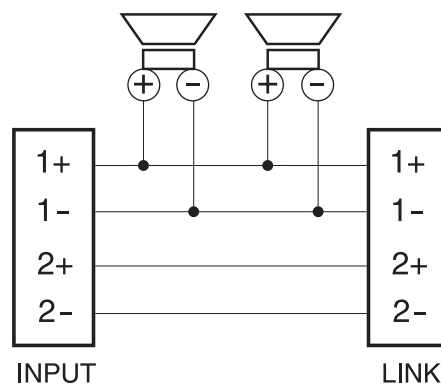

---

---

# Additional information

---

---

## Dimensions

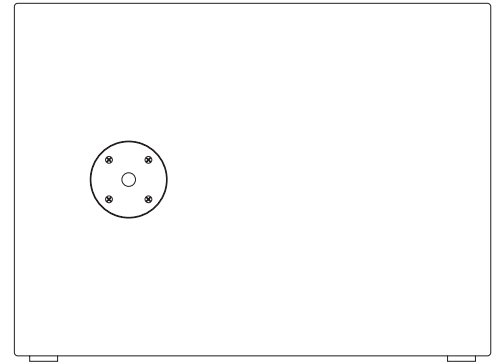
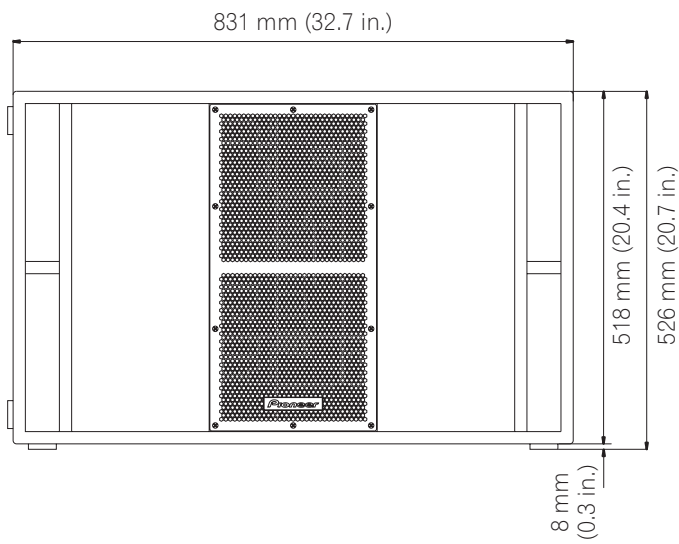
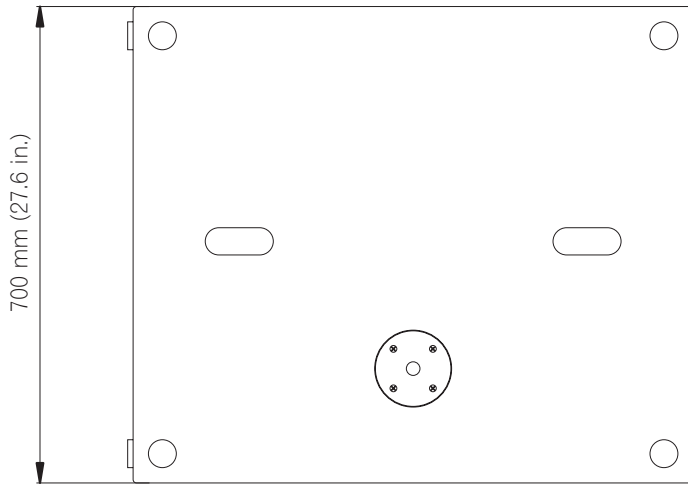



---

---

## About trademarks and registered trademarks

- Pioneer is a registered trademark of PIONEER CORPORATION.
- SpeakON is a registered trademark of Neutrik.

The names of companies and products mentioned herein are the trademarks of their respective owners.

---

---

## Specifications

Enclosure Type	Dual driver, quasi-bandpass subwoofer
Frequency Response	42 Hz to 160 Hz
Sensitivity (1 W/1 m)	102 dB (half space)
Nominal Impedance	4 $\Omega$
Power Handling	800 W RMS, 1600 W Programme
Maximum SPL	131 dB cont., 137 dB peak (half space)
Dispersion	—
Driver Configuration	2 $\times$ 15 inch (381 mm) ferrite LF cone drivers
Crossover	—
Connectors	2 $\times$ Neutrik SpeakON™ NL4MP
Dimensions (W $\times$ H $\times$ D)	831 mm $\times$ 526 mm $\times$ 700 mm (32.7 inch $\times$ 20.7 inch $\times$ 27.6 inch)
Weight	71 kg (156.6 lb)
Rigging and Hardware	4 $\times$ flush handles, 2 $\times$ M20 polemount sockets for mid/high enclosures, 8 $\times$ rubber feet (bottom and left) and 4 $\times$ mating recesses (top), 16 $\times$ M10 threaded points for 4 $\times$ castors on rear
Grille	Hex punched steel
Enclosure	18 mm (0.7 inch) birch plywood
Finish	Impact-resistant, Black semi-matt textured

The specifications and design of this product are subject to change without notice.

---

**PIONEER CORPORATION**

1-1, Shin-ogura, Saiwai-ku, Kawasaki-shi, Kanagawa 212-0031, Japan

**パイオニア株式会社**

〒212-0031 神奈川県川崎市幸区新小倉1番1号

**Корпорация Пайонир**

1-1, Син-Огура, Сайвай-ку, г. Кавасаки, префектура Канагава, 212-0031, Япония

**Импортер: ООО "ПИОНЕР РУС"**

125040, Россия, г. Москва, ул. Правды, д.26 Тел.: +7(495) 956-89-01

**PIONEER EUROPE NV**

Haven 1087, Keetberglaan 1, B-9120 Melsele, Belgium TEL: 03/570.05.11

**PIONEER ELECTRONICS (USA) INC.**

P.O. BOX 1720, Long Beach, California 90801-1720, U.S.A. TEL: (800) 421-1404

**PIONEER ELECTRONICS ASIACENTRE PTE. LTD.**

253 Alexandra Road, #04-01, Singapore 159936 TEL: 65-6472-7555

**PIONEER ELECTRONICS AUSTRALIA PTY. LTD.**

5 Arco Lane, Heatherton, Victoria, 3202, Australia, TEL: (03) 9586-6300

**PIONEER ELECTRONICS (THAILAND) CO., LTD.**

17th Fl., KPN Tower, 719 Rama 9 Road, Bangkapi, Huaykwang, Bangkok 10310 TEL: 66-2-717-0777

**PIONEER TECHNOLOGY (MALAYSIA) SDN. BHD**

16th Floor, Menara Uni. Asia 1008 Jalan Sultan Ismail 50250 Kuala Lumpur TEL: 60-3-2697-2920

**先鋒股份有限公司**

台灣台北市內湖區瑞光 407 號 8 樓 TEL: 886-(0)2-2657-3588

**先鋒電子(香港)有限公司**

香港九龍長沙灣道 909 號 5 樓 TEL: 852-2848-6488

**PIONEER GULF FZE**

Lob 11-017, Jebel Ali Free Zone P.O. Box 61226, Jebel Ali Dubai TEL: 971-4-8815756

**PIONEER ELECTRONICS DE MEXICO S.A. DE C.V.**

Bldv.Manuel Avila Camacho 138 10 piso Col.Lomas de Chapultepec, Mexico, D.F. 11000 TEL: 55-9178-4270

**PIONEER INTERNATIONAL LATIN AMERICA S.A.**

Plaza Credicorp Bank, 14th Floor, Calle 50, No.120 Panama City 0816-01361 Republic of Panama TEL: 507-300-3900

**PIONEER KOREA CORPORATION (PKC)**

파이오니아코리아(주) 121-020 서울특별시 마포구 공덕동 105-219 정화빌딩 TEL: 02-777-8005