

RMS Compact II User Manual

Version 1.0.6
20th February 2009

Conventions Used in this Manual

This manual uses the following typographic conventions:

Table 1-1. Typographic Conventions

<i>italics</i>	Items as seen on screen, field names, menu names, button text etc.
bold	Indicates items that require special emphasis.
fixed	Inputs by the user that must be typed exactly as they appear.
{somevalue}	Italics surrounded by curly braces indicate a user supplied entry that must be input. E.g.: {drive} : \setup
<ctrl+alt+delete>	Text surrounded by angled brackets indicate specific keys to be pressed. Use of the + sign in combination indicate that keys should be pressed together.

Note! *Information of note may be presented like this.*

Warning! *These messages alert you to specific procedures or practices; serious consequences may result including injury if you disregard them.*

About this Manual

This manual is intended to document the RMS Compact II product.

Throughout this document it is assumed that the user has a basic to intermediate knowledge of IT and Networking concepts.

Further information regarding IT and Networking fundamentals may be found in the appendices of this document.

Copyright © 2009
Unauthorised reproduction prohibited.

Table of Contents

Conventions Used in this Manual	2
About this Manual	3
1 Introduction	6
Overview.....	6
2 RMS Compact II Package.....	8
Package contents	8
Front of RMS Compact II MCU	8
Rear of RMS Compact II MCU.....	9
Installation Requirements	11
3 Initial Setup.....	12
Installation into a 19" rack.....	12
Zero-U 19" rack installation.....	13
Default Settings	15
Connecting to the Web Management Interface.....	15
Initial network setup.....	20
4 Web Management Interface.....	25
Network Setup - Overview	25
Network Setup - IP Configuration	26
Network Setup - HTTP.....	27
Network Setup – LDAP Servers.....	29
Network Setup - SNMP NMS.....	31
Network Setup - SNMP Trap Receivers	32
Network Setup - Users.....	33
Network Setup – Restart.....	35
Input Sensors – Status	36
Input Sensors – Defaults.....	37
Input Sensors - Configure.....	41
Relays – Status.....	43
Relays – Configure	44
Relays – Configure - Config.....	46
5 LDAP	48
RMS Compact II LDAP Overview	48
RMS Compact II LDAP Structure.....	48
6 Troubleshooting.....	51
Resetting RMS Compact II to factory default settings.....	51
The NMS cannot poll the RMS Compact II	51
7 Appendix A: Technical Details	52
Factory Default Settings.....	52
Operating Information	52
8 Appendix B: Hysteresis Demystified.....	53
How Hysteresis works	53

9 Appendix C: Custom Sensor Cable 55
 Custom sensor cable for RMS Compact II..... 55
 Application example..... 55
10 Appendix D: Networking Reference..... 56
 Reference 56

1 Introduction

Overview

RMS Compact II is a low cost networkable zero-U rack monitoring device. The RMS Compact II provides both SNMP and Web monitoring and management.

Some of the main features of the RMS Compact II unit are:

- Modular design permits future expansion.
- Secure web management and configuration interface.
- SNMP enabled.
- Twelve monitoring channels.
- Optional LCD Status module.

Safety and Installation Statement

Grounding

This is a class II product using double insulation to provide electrical safety of the product from the main power source.



For correct operation and improved safety the 4mm earth stud (labeled “Earth” on rear face of unit) should be connected to an electrical earth ground.

If the network covers an area served by more than one power distribution system, be sure their electrical safety grounds are securely interconnected.

Network cabling may occasionally be subject to hazardous transient voltages (such as lightning or disturbances in the electrical utilities power grid). Handle exposed metal components of the installation with caution.

Servicing

There are no user-serviceable parts inside these products. Any maintenance or repair must be performed by approved service-trained personnel.

This product does not have a power switch; it is powered on when the adapter’s power cord is plugged in.

Waste Electrical and Electronic Equipment (WEEE) Statements

Disposal of Waste Equipment by Users in Private Household in the European Union

This product must not be disposed of with your other household waste. It is your responsibility to dispose of your WEEE equipment by handing it over to a designated collection point for the recycling of waste electrical and electronic equipment.

For more information about where you can drop off your waste equipment for recycling, please contact your local city or council office, your household waste disposal service or the organisation where you purchased the product.

EC Declaration of Conformity In accordance with EN ISO 17050-1:2005

In accordance with the following Directives:

- 2006/95/EC The Low Voltage Directive
- 2004/108/EC The Electromagnetic Compatibility Directive
- 2002/95/EC The Restriction of the Use of certain Hazardous Substances in Electrical and Electronic Equipment (RoHS)

The equipment: **RMS Compact II**

Model Numbers: **ZARMSCS2-01 (Knr: 061082008)**

Is in conformity with the applicable requirements of the following documents

Ref No.	Title
BS EN 55022:1998	Information technology equipment. Radio disturbance characteristics. Limits and methods of measurement. Class A.
BS EN 55024:1998+A2:2003	Information technology equipment. Immunity characteristics. Limits and methods of measurement.
BS EN 60950-1:2006	Information technology equipment. Safety. General requirements

2 RMS Compact II Package

Package contents

The standard RMS Compact II package contains a RMS Compact II unit with supporting hardware:

Table 2-1. Package contents

RMS Compact II Master Control Unit.
12vDC 1000mA PSU
19" rack mounting kit.
'Zero U' mounting bracket

Front of RMS Compact II MCU

The following images show the front and rear panels of the RMS Compact II Master Control Unit (MCU):



Figure 2-1. Front of RMS Compact II MCU.

LEDs

Five LEDs can be found on the front of the RMS Compact II MCU. Their purpose is described below.

- Network Link:** Illuminates when Ethernet link is established and flashes with data.
- Network Speed:** Illuminates when Fast Ethernet is active (100mbps).
- Status:** Indicates system activity.
- Alarm:** Illuminates when there is an alarm present on the unit.
- Power:** Illuminates when unit is powered.

Buttons

Also found on the front of the RMS Compact II MCU are two buttons, their functions are described below.

- Reset:** Allows the user to reboot the unit.
- Mode:** The mode select switch is used to reset the unit to factory defaults. See the Troubleshooting section for details.

Rear of RMS Compact II MCU



Figure 2-2 Rear of RMS Compact II MCU.



Figure 2-3 RMS Compact II Relay connections.

- Power Inlet:** Power inlet supporting 12 Volts DC.
- DC Relay (Relay 1):** Output rated 48VDC/VAC @ 750mA Presented on Screw-Lock Weidmuller connector
- AC Relays (2-3):** Outputs rated 240VAC @ 3A presented on Screw-lock Phoenix Type connector
- Sensor Inputs (twelve):** Twelve sensor inputs are provided for connection of external contacts, temperature and humidity sensors.
- Network Connector:** An RJ-45 connection provides Ethernet and Fast Ethernet connectivity to the RMS Compact II MCU.

Installation Requirements

- RMS Compact II Master Control Unit (MCU).
- 100 – 240V AC Power supply
- Ethernet or Fast Ethernet network connection.
- Network connected computer system to setup the RMS Compact II MCU.

3 Initial Setup

Installation into a 19" rack

There are two ways of mounting RMS Compact II into a 19" rack system. The first is in the standard horizontal 19" rack configuration.

Using the 1U Adapter Brackets

The unit can be mounted in the rack as a standard 1U unit, using the supplied adapter brackets. The fitting instructions are shown below:

Step One – Fit cage nuts

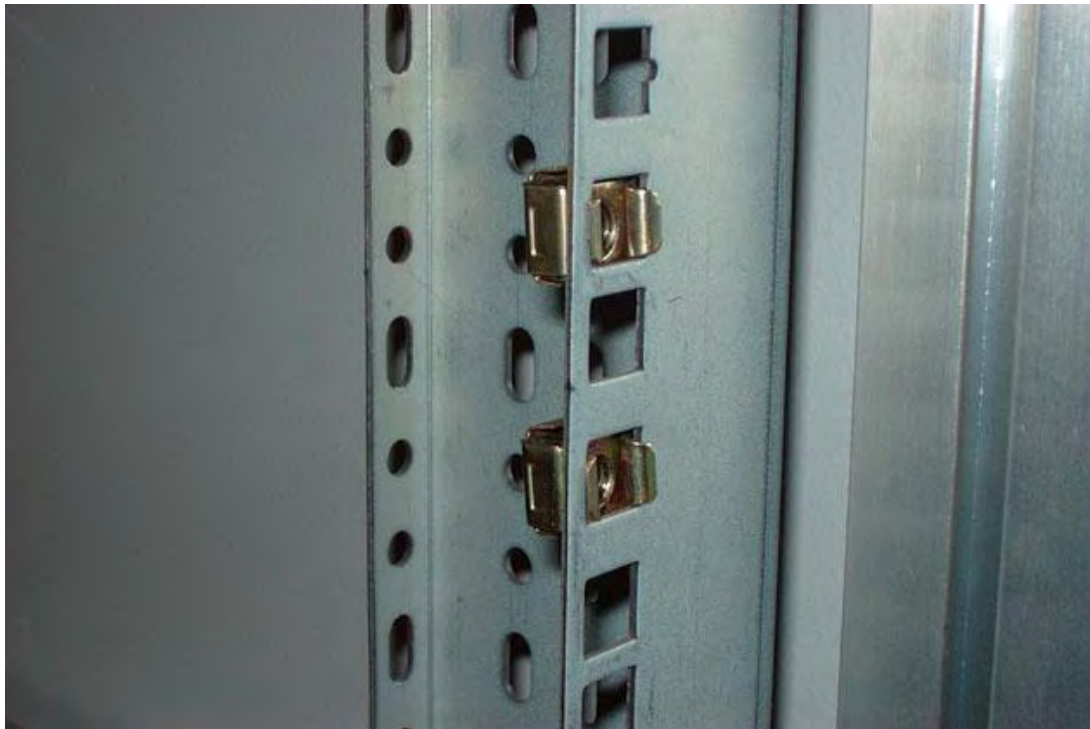

Figure 3-1. Fit cage nuts (not supplied).

Step Two – Attach mounting brackets



Figure 3-2. Attach supplied 19" mounting brackets.

1U mounting brackets are attached as above using 4 screws (supplied).

Step Three – Screw RMS Compact II into rack

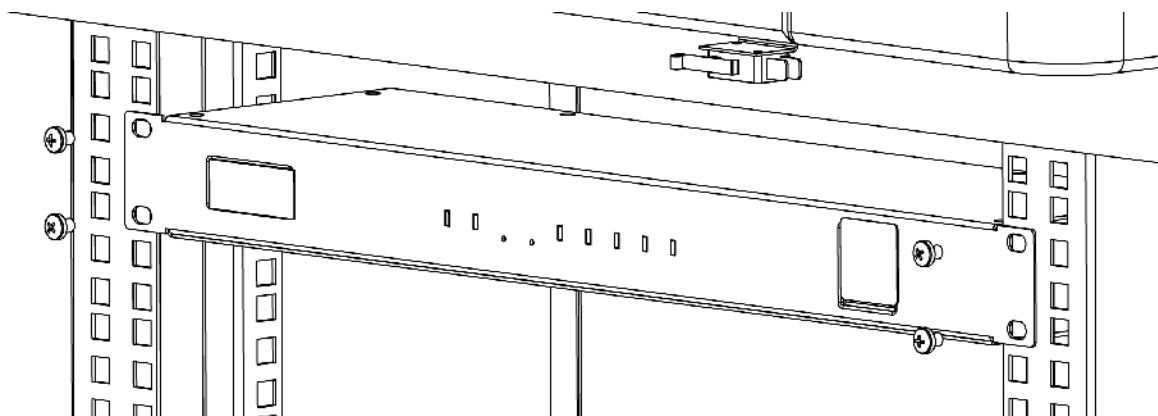

Figure 3-3. Screw RMS Compact II into rack.

Step Four– Make connections

Connect Power, Ethernet connection, Relay Output and sensor cables

Zero-U 19" rack installation

The second method of installing the RMS Compact II MCU into a 19" rack is the Zero-U option.

The provided Zero-U rack mount bracket allows the unit to be placed in the **vertical** position at the side of a rack.

Warning! *The RMS Compact II unit must not be mounted horizontally using the Zero-U bracket. Mounting in this way may damage the unit.*



Figure 3-4. RMS Compact II with zero U mounting bracket attached for vertical mounting

Default Settings

The RMS Compact II unit in factory default condition will have the following network configuration. Advanced users may wish to make use of these settings to access the RMS Compact II units web management interface immediately and proceed with configuration.

Users who do not know how to do this should proceed through this chapter for information on how to configure the RMS Compact II unit.

Table 3-1. RMS Compact II Defaults

IP Address:	192.168.0.253
Subnet Mask:	255.255.255.0
Default Gateway:	192.168.0.1
Web Management Address:	http://192.168.0.253/
Default username:	admin
Default password	admin

Note! ***Password entries are case sensitive!***

Connecting to the Web Management Interface

The RMS Compact II monitoring solution can be configured entirely using the built in web management interface.

In order to connect to the web management interface for the first time the IP address of the PC to be used may need to be changed.

This section will detail how to connect to change the IP address and connect to the web management interface.

Changing your PCs IP address

Note! *Instructions refer specifically to Windows XP Professional. Please refer to your operating system documentation if you are not using Windows XP Professional.*

- 1) On Windows XP Start menu **<Right Click>** on **My Network Places** then right click on **Properties**. This can be seen in Figure 3-4. My Network Places.

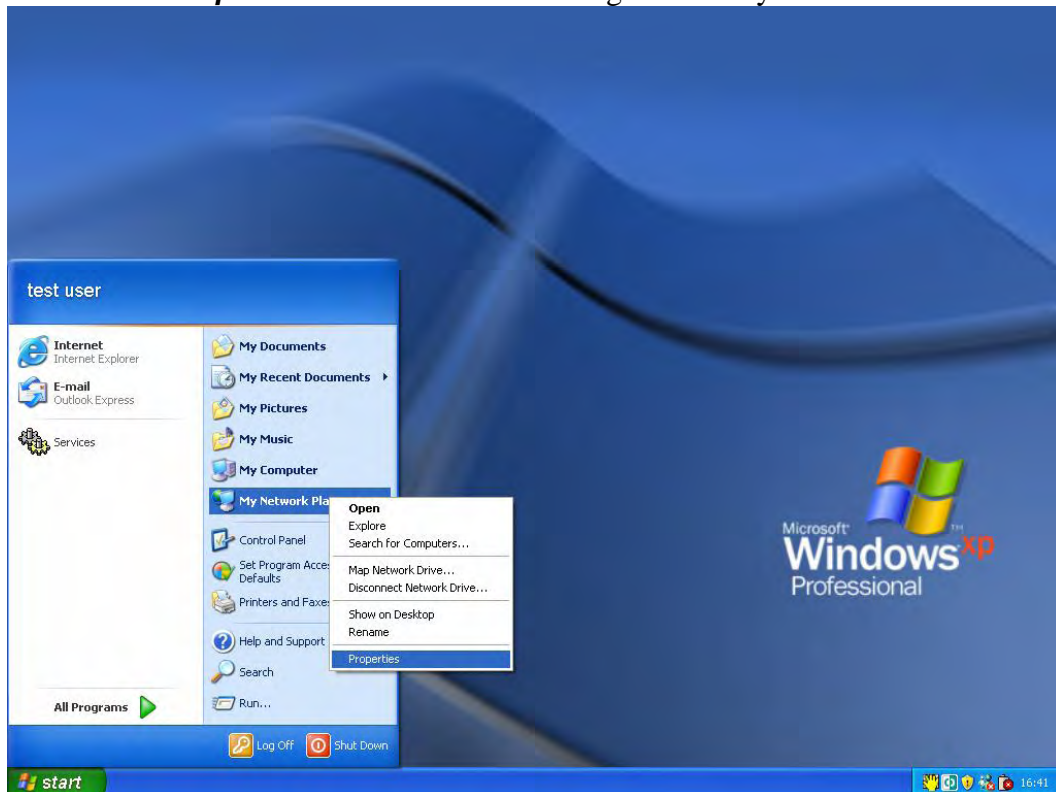

Figure 3-4. My Network Places

- 2) The Network Connections window will appear as shown in Figure 3-5.
Network Connections window

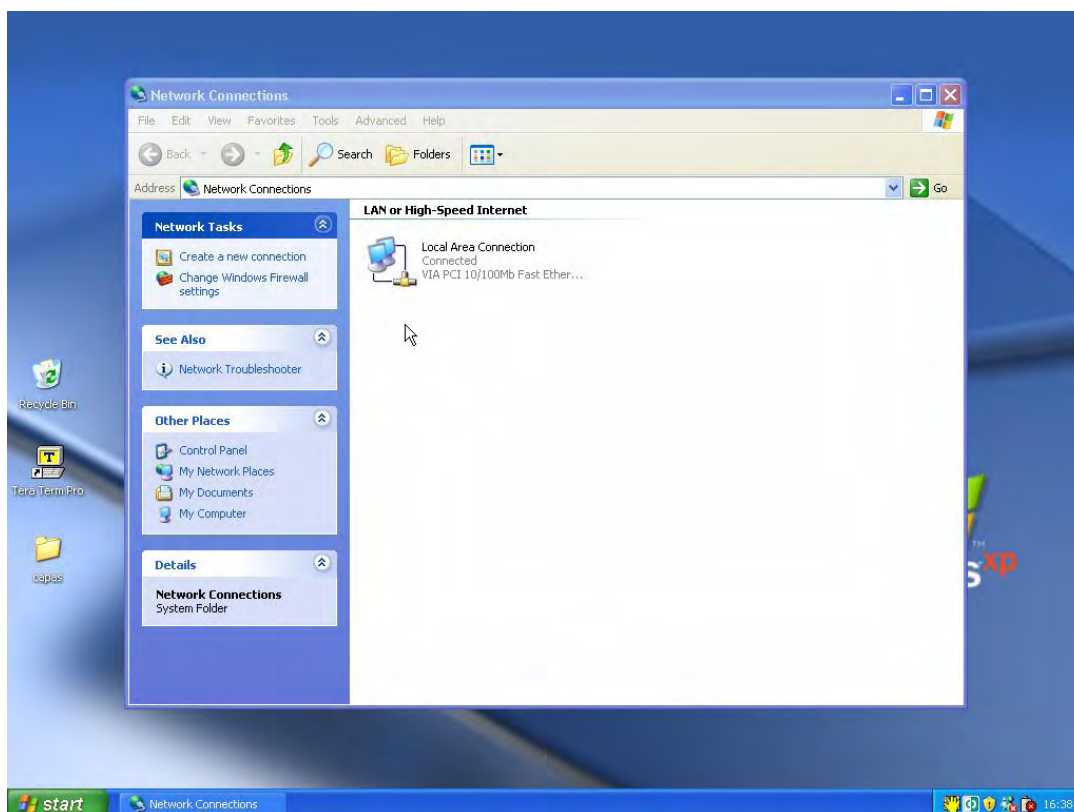

Figure 3-5. Network Connections window

- 3) **<Right Click>** on Local Area Connection and click on **Properties**. This will open the Local Area Connection Properties window as shown in Figure 3-6. Local Area Connection Properties window.

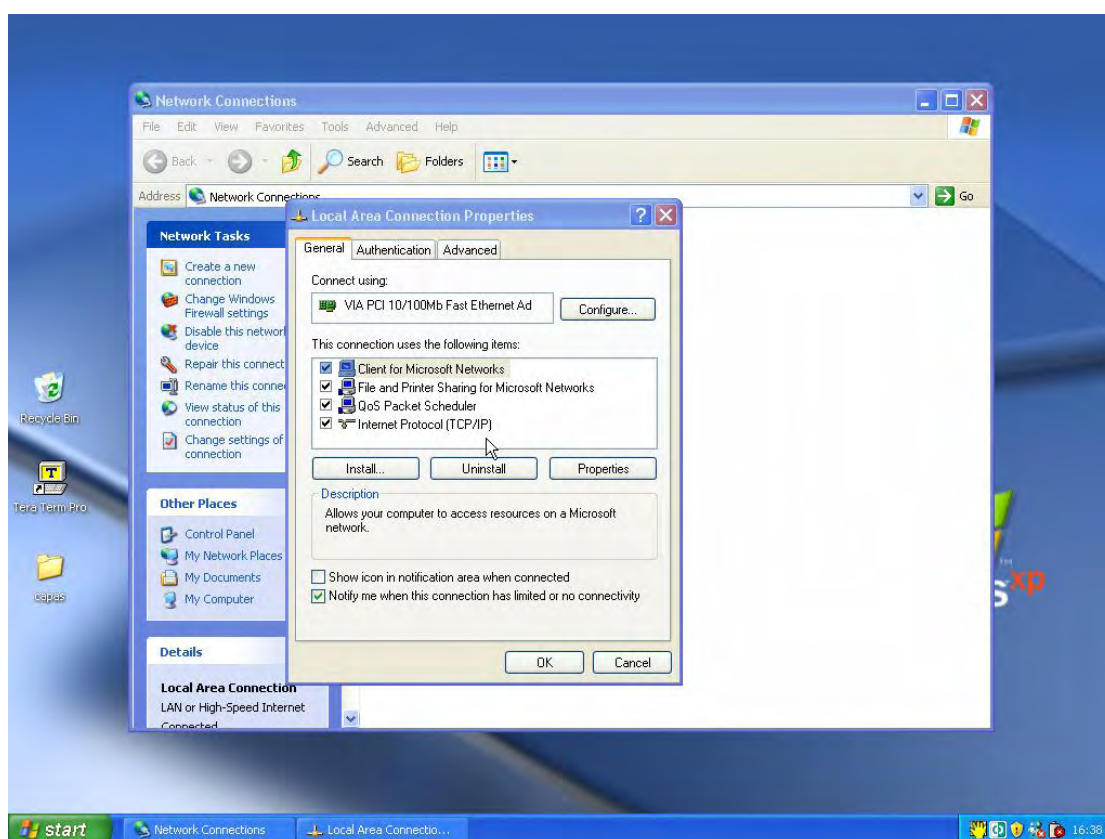

Figure 3-6. Local Area Connection Properties window.

- 4) Select **Internet Protocol (TCP/IP)** (you may need to scroll down). Click the **Properties** button.
- 5) Select **Use the following IP address** and **Use the following DNS server addresses** radio buttons. Proceed to enter the following details into the appropriate boxes. (This can be seen in Figure 3-7. Internet Protocol (TCP/IP) Properties screen)

IP address: 192.168.0.10
Subnet mask: 255.255.255.0
Default gateway: 192.168.0.1

Preferred DNS server: 192.168.0.1

Click **OK** to accept the entries.

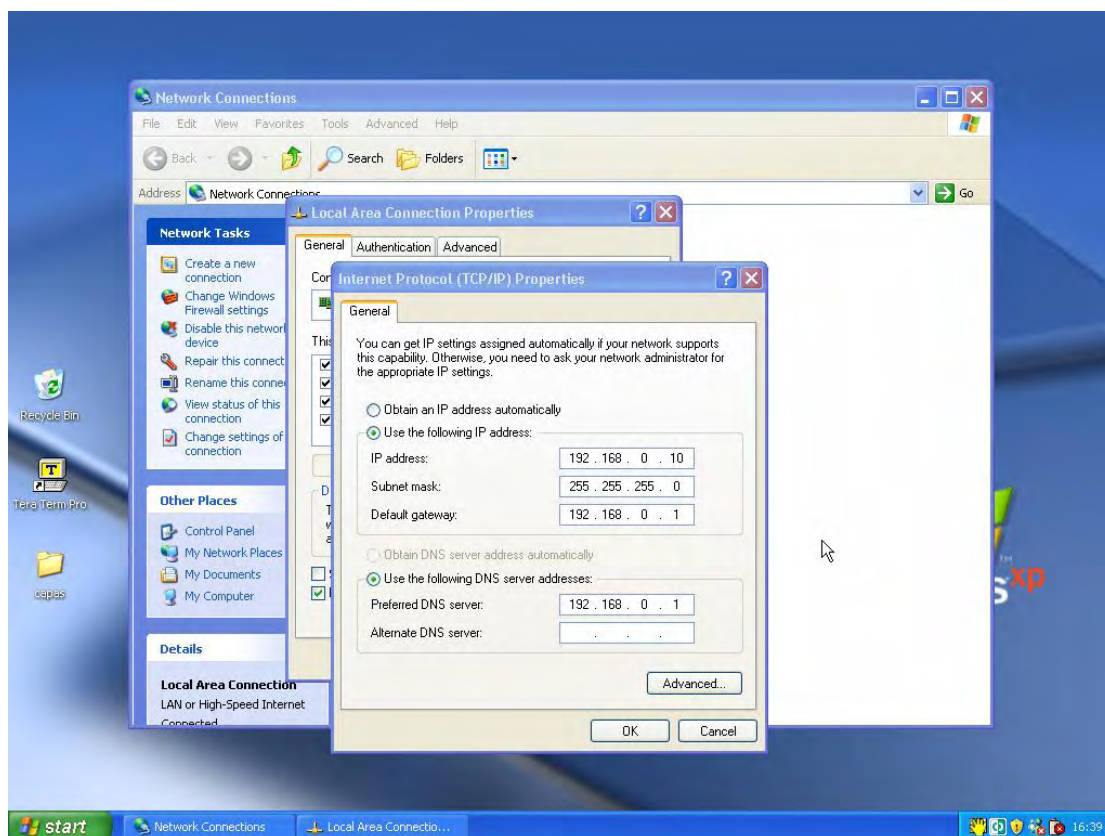

Figure 3-7. Internet Protocol (TCP/IP) Properties screen

- 6) On the Local Area Connection Properties Click **OK** to return to the desktop.

Congratulations you have just changed your IP address and can now proceed with the next stage of the RMS Compact II Rack Monitor setup.

Connecting to the web management interface

- 1) Connect the RMS Compact II MCUs network connection directly to a PC's Ethernet network card using a **crossover cable**.

Note! *A crossover cable must be used when directly connected the RMS Compact II MCU to a PC's network card.*

- 2) Power the RMS Compact II unit.
- 3) Open a web browser.
- 4) Enter into the address bar `http://192.168.0.253`

5) The Web Management Interface will now load.



Figure 3-8. Web Management Interface login screen.

6) Click login and enter the username and password. The unit defaults are:-

Default username:	admin
Default password	admin

Table 3-2. Default Passwords.

Note! Password entries are case sensitive!

Initial network setup

This section provides details on preparing the unit for network access and allowing SNMP network management.

Connection to the web management interface is required.

Entering NMS details

- 1) Click the **Network Setup** tab on the top menu bar then select the **SNMP NMS** button found on the left menu bar.

knürr
environment for electronics

RMS
compact

Logged In: admin (Administrator)
System Name: sysName
Logout

Setup Input Sensors Relays

Setup / SNMP (Network Management Stations)

Overview
IP Config
HTTP
LDAP Servers
SNMP NMS
SNMP Rec'rs
Users
Email Alerts
Time Settings
Syslog Servers
Preferences
Restart

The IP address, community string and access permissions are specified here for up to 5 Network Management Stations. Any machine which must access this unit's SNMP functions must be entered here.

Read Only access permits the NMS to use only GET commands.
Read / Write access permits the NMS to use both GET and SET commands.

	NMS IP Address:	Community String:	NMS Access:
NMS 1	<input type="text" value="0.0.0.0"/>	<input type="text"/>	<input type="button" value="Read Only"/> ▾
NMS 2	<input type="text" value="0.0.0.0"/>	<input type="text"/>	<input type="button" value="Read Only"/> ▾
NMS 3	<input type="text" value="0.0.0.0"/>	<input type="text"/>	<input type="button" value="Read Only"/> ▾
NMS 4	<input type="text" value="0.0.0.0"/>	<input type="text"/>	<input type="button" value="Read Only"/> ▾
NMS 5	<input type="text" value="0.0.0.0"/>	<input type="text"/>	<input type="button" value="Read Only"/> ▾

Save

Figure 3-9. SNMP NMS Setup.

- 2) Input the IP address, chosen community string and required NMS access permissions of the Network Management Stations to be used.
- 3) Click **Save** to confirm the changes.
- 4) To disable an NMS the **Disabled** entry should be selected from the **NMS Access** drop down list.

Entering Trap Receiver details

- 1) Click the **Network Setup** tab on the top menu bar then select the **SNMP Rec's** button found on the left menu bar.

Logged In: admin (Administrator)
System Name: sysName
Logout

Setup / SNMP (Receivers)

The IP address, community string and access permissions are specified here for up to ten Network Management Stations. Any machine which will be required to receive SNMP traps sent from this unit must be entered here. Usually any SNMP NMS entries should also be entered here.
Receive traps Enabled setting allows the specified NMS to receive the units standard range of traps. Receive traps Enabled (incl Auth fails), will cause the unit to issue traps if an unauthorised IP address attempts to access the units SNMP functions.

	Receiver IP Address:	Community String:	Receive Traps:
Receiver 1	<input type="text" value="0.0.0.0"/>	<input type="text"/>	Disabled
Receiver 2	<input type="text" value="0.0.0.0"/>	<input type="text"/>	Disabled
Receiver 3	<input type="text" value="0.0.0.0"/>	<input type="text"/>	Disabled
Receiver 4	<input type="text" value="0.0.0.0"/>	<input type="text"/>	Disabled
Receiver 5	<input type="text" value="0.0.0.0"/>	<input type="text"/>	Disabled
Receiver 6	<input type="text" value="0.0.0.0"/>	<input type="text"/>	Disabled
Receiver 7	<input type="text" value="0.0.0.0"/>	<input type="text"/>	Disabled
Receiver 8	<input type="text" value="0.0.0.0"/>	<input type="text"/>	Disabled
Receiver 9	<input type="text" value="0.0.0.0"/>	<input type="text"/>	Disabled
Receiver 10	<input type="text" value="0.0.0.0"/>	<input type="text"/>	Disabled

Save

Figure 3-10. Trap Receivers setup

- 2) The IP address, chosen community string and required trap types should be entered for the Network Management Stations to be used.
- 3) Click **Save** to confirm the changes.

Adding users

- 1) Click the **Network Setup** tab on the top menu bar then select the **Users** button found on the left menu bar.

Administrator: Configuration settings can be viewed and modified.
Controller and viewer: Configuration settings can only be viewed.

	Username:	Password:	Level:
User 1	admin		Administrator
User 2			Administrator
User 3			Administrator
User 4			Administrator
User 5			Administrator
User 6			Administrator
User 7			Administrator
User 8			Administrator
User 9			Administrator
User 10			Administrator
User 11			Administrator
User 12			Administrator
User 13			Administrator
User 14			Administrator
User 15			Administrator
User 16			Administrator
User 17			Administrator
User 18			Administrator
User 19			Administrator
User 20			Administrator

Save

Figure 3-11. User menu

- 2) Usernames, passwords and access levels can be set here. Unique usernames can be set for individuals who require web management access to the RMS Compact II unit.
- 3) Click **Save** to confirm the changes.

Changing the unit IP address

- 1) Click the **Network Setup** tab on the top menu bar then select the **Users** button found on the left menu bar.

Network settings for this unit are set here. This will be the IP address that is used to access the web management interface and by a Network Management Station.

System Name:	<input type="text" value="sysName"/>
IP Address:	<input type="text" value="192.168.0.189"/>
Subnet Mask:	<input type="text" value="255.255.255.0"/>
Gateway:	<input type="text" value="192.168.0.1"/>

Figure 3-12. IP Configuration

- 2) The IP address, subnet mask and gateway that the RMS Compact II will use must be entered here.

Contact your network administrator if you do not know the values that you must enter here.

- 3) Click **Save** to confirm the changes.
- 4) Click **Restart** and select **Restart Now** to reboot the unit and bring the changes into effect.

Note! *Once the IP configuration has changed the RMS Compact II unit will no longer be accessible via the default IP address as the new address will be operational.*

- 5) The RMS Compact II unit should now be connected to the main network and any further required configuration done via the units new IP address.

4 Web Management Interface

The RMS Compact II unit has a built in Web Management interface which can be accessed securely. The interface permits complete configuration and monitoring of the RMS Compact II unit.

Pages where changes can be made have a **Save** button in the lower right hand area. This must be pressed to action and save any changes made.

Network Setup - Overview

The Overview page is the first page displayed and provides the user with an overview of the RMS Compact II units' current status.

Logged In: admin (Administrator)
System Name: sysName
Logout

Setup Input Sensors Relays

Network Setup / Overview

Overview	System Name:	sysName
IP Config	MAC Address:	00:07:6e:02:20:00
HTTP	Serial Number:	Unknown
LDAP Servers	Firmware Version:	1.02.02
SNMP NMS	Hardware Revision:	Unknown
SNMP Rec'rs	System Uptime:	0 days, 0 hours, 25 mins, 1 secs
Users	IP Address:	192.168.0.189
Email Alerts	Subnet Mask:	255.255.255.0
Time Settings	Gateway:	192.168.0.1
Syslog Servers	Logged In User:	admin
Preferences	Access Level:	Administrator
Restart		

Figure 4-1. Overview screen.

System name, MAC address, serial number, firmware version and a selection of other system details can be found here.

Network Setup - IP Configuration

The IP Config page permits setting of the RMS Compact II units own management IP address.

Logged In: admin (Administrator)
System Name: sysName
Logout

Setup / IP Configuration

Network settings for this unit are set here. This will be the IP address that is used to access the web management interface and by a Network Management Station.

System Name:

IP Address:

Subnet Mask:

Gateway:

Save

Figure 4-2. IP Configuration

System Name

System name may be specified here. This would normally be the fully qualified domain name (FQDN) of the device but this is not enforced.

The value specified here can be retrieved by interrogating the 'sysName' node via SNMP.

This allows SNMP management platforms to obtain unique names for units where specified.

This value has no effect on network communications and the unit will function correctly with or without a value.

IP Address

A standard IP address may be entered here. The address is entered in dotted decimal format.

Eg: 192.168.0.44 or 22.10.45.33

The address entered here will be the address by which the RMS Compact II unit is accessed and managed.

Subnet Mask

The subnet mask is used to determine what part of the IP address is the network portion and what part is the host portion.

It is often 255.255.0.0 or 255.255.255.0 however correct setting is essential for correct operation.

The subnet mask is entered in dotted decimal format.

Eg: 255.255.255.0 or 255.255.224.0

Gateway

The gateway setting specifies the IP address of the machine/router which the RMS Compact II unit uses to communicate with different networks.

The gateway address is entered in dotted decimal format.

Eg: 192.168.0.1 or 11.2.24.103

Most networks will have a gateway and correct setting is important for correct network communications.

Note! ***Once IP Configuration options are entered and Save is pressed the changes will take effect. If incorrect entries are made this may result in loss of communication.***

In this event the best course of action is to reset the RMS Compact II units' network configuration.

Details of how to do this can be found in the Troubleshooting section.

Network Setup - HTTP

Access method for the web management interface is selected here.

Both HTTP and HTTPS access modes are available by default. Selecting the HTTPS radio button will allow only HTTPS configuration.

Use of HTTPS is recommended for security as connections will be encrypted.

Additionally the TCP port for connection to the Web Management Interface can be specified here.

Note! **Selecting HTTP or HTTPS requires a reboot to take effect.**



Figure 4-3. HTTP Setup

Network Setup – LDAP Servers

Lightweight Directory Access Protocol (LDAP) configuration options are specified here.

See Section 5 LDAP (Page 48) for configuration details.

Logged In: admin (Administrator)
System Name: sysName
Logout

Setup / LDAP Servers

Enabled: Enabled Disabled

Credential Cache: Minutes (Timeout)

Primary LDAP Server

Display Name:

IP Address:

Unit Base DN:

Users Base DN 1:

Users Base DN 2:

Secondary LDAP Server

Display Name:

IP Address:

Unit Base DN:

Users Base DN 1:

Users Base DN 2:

Save

Figure 4-4. LDAP Setup

Configuration options for a Primary and Secondary server are provided with identical configuration choices offered.

Enabled

Disabled

No LDAP servers will be queried to verify user login credentials access and privileges. Only internal users will be able to login.

Primary

Only the Primary LDAP Server specified will be queried to verify user login credentials access and privileges.

Secondary

Only the Secondary LDAP Server specified will be queried to verify user login credentials access and privileges.

Both

Both LDAP Servers specified will be queried (with priority given to the Primary) to verify user login credentials access and privileges.

Credential Cache

Specifies how long (in minutes) users successfully authenticated via LDAP will be allowed to access the unit without re-authenticating against LDAP.

Display Name

A display name for the specified LDAP server can be specified here. Display Name is for reference and logging purposes and has no direct affect on LDAP function.

IP Address

The IP address of the LDAP server is specified here.

Unit Base DN

The Distinguished Name (DN) of the directory object containing the RMS Compact II LDAP authentication structure must be provided here. This field is required for LDAP function.

See Section 5 LDAP (Page 48) for configuration details.

Users Base DN 1

The Distinguished Name (DN) of the directory object containing directory users for authentication is specified here.

This field is required for LDAP function.

See Section 5 LDAP (Page 48) for configuration details.

Users Base DN 2

The Distinguished Name (DN) of the directory object containing directory users for authentication is specified here.

This field is optional for LDAP function providing Users Base DN 1 has been specified.

See Section 5 LDAP (Page 48) for configuration details.

Network Setup - SNMP NMS

The IP address, community string and access permissions are specified here for up to 5 Network Management Stations.

Any machine which must access this unit's SNMP functions must be entered here.

Logged In: admin (Administrator)
System Name: sysName
Logout

Setup / SNMP (Network Management Stations)

The IP address, community string and access permissions are specified here for up to 5 Network Management Stations. Any machine which must access this unit's SNMP functions must be entered here.

Read Only access permits the NMS to use only GET commands.
Read / Write access permits the NMS to use both GET and SET commands.

	NMS IP Address:	Community String:	NMS Access:
NMS 1	<input type="text" value="0.0.0.0"/>	<input type="text"/>	Read Only
NMS 2	<input type="text" value="0.0.0.0"/>	<input type="text"/>	Read Only
NMS 3	<input type="text" value="0.0.0.0"/>	<input type="text"/>	Read Only
NMS 4	<input type="text" value="0.0.0.0"/>	<input type="text"/>	Read Only
NMS 5	<input type="text" value="0.0.0.0"/>	<input type="text"/>	Read Only

Save

Figure 4-5. SNMP NMS

IP Address

The IP address of the NMS machine should be entered here.

Community String

The required community string must be entered here. The default for many devices is **public**.

It is recommended that the community string be changed as it is effectively an access password.

NMS Access

Read Only access permits the NMS to use only GET commands.

Read / Write access permits the NMS to use both GET and SET commands.

Network Setup - SNMP Trap Receivers

The IP address, community string and access permissions are specified here for up to five Network Management Stations.

Logged In: admin (Administrator)
System Name: sysName
Logout

Setup / SNMP (Receivers)

The IP address, community string and access permissions are specified here for up to ten Network Management Stations. Any machine which will be required to receive SNMP traps sent from this unit must be entered here. Usually any SNMP NMS entries should also be entered here.
Receive traps Enabled setting allows the specified NMS to receive the units standard range of traps. Receive traps Enabled (incl Auth fails), will cause the unit to issue traps if an unauthorised IP address attempts to access the units SNMP functions.

	Receiver IP Address:	Community String:	Receive Traps:
Receiver 1	0.0.0.0		Disabled
Receiver 2	0.0.0.0		Disabled
Receiver 3	0.0.0.0		Disabled
Receiver 4	0.0.0.0		Disabled
Receiver 5	0.0.0.0		Disabled
Receiver 6	0.0.0.0		Disabled
Receiver 7	0.0.0.0		Disabled
Receiver 8	0.0.0.0		Disabled
Receiver 9	0.0.0.0		Disabled
Receiver 10	0.0.0.0		Disabled

Save

Figure 4-6. SNMP Trap Receivers

IP Address

Any machine which will be required to receive SNMP traps sent from this unit must be entered here. Usually any SNMP NMS entries should also be entered here.

Community String

The required community string must be entered here. The default for many devices is **public**.

It is recommended that the community string be changed as it is effectively an access password.

Receive Traps

Receive traps **Enabled** setting allows the specified NMS to receive the units standard range of traps.

Receive traps **Enabled (incl Auth fails)**, will cause the unit to issue traps if an unauthorised IP address attempts to access the units SNMP functions.

Receive traps **Disabled** prevents traps from being sent to the specified NMS IP address.

Network Setup - Users

Users with permission to access the Web Management Interface can be added here. Access passwords are also specified along with users access permissions.

Logged In: admin (Administrator)
System Name: sysNan
Logo

Setup / Users

Administrator: Configuration settings can be viewed and modified.
Controller and Viewer: Configuration settings can only be viewed.

	Username:	Password:	Level:
User 1	admin		Administrator
User 2			Administrator
User 3			Administrator
User 4			Administrator
User 5			Administrator
User 6			Administrator
User 7			Administrator
User 8			Administrator
User 9			Administrator
User 10			Administrator
User 11			Administrator
User 12			Administrator
User 13			Administrator
User 14			Administrator
User 15			Administrator
User 16			Administrator
User 17			Administrator
User 18			Administrator
User 19			Administrator
User 20			Administrator

Save

Figure 4-7. User Setup

Username

The required username is entered here. This is the username that will be required to login to the Web Management Interface.

Password

Access passwords are entered here on a per user basis.

Level

Three user levels are available for assignment.

Administrator

Administrators have full control of RMS Compact II configuration settings.

Controller

Controllers are able to view configuration settings.

Viewer

Viewers are able to view configuration settings.

Warning! *User 1 / admin is the master administrator. It is possible to remove administrator rights from the admin user. Doing this is not recommended as it may leave you without administrator access.*

In this situation a reset to factory defaults is the only solution.

Details on how to do this can be found in the Troubleshooting section.

Network Setup – Restart

A unit may be rebooted or reset to factory defaults here.

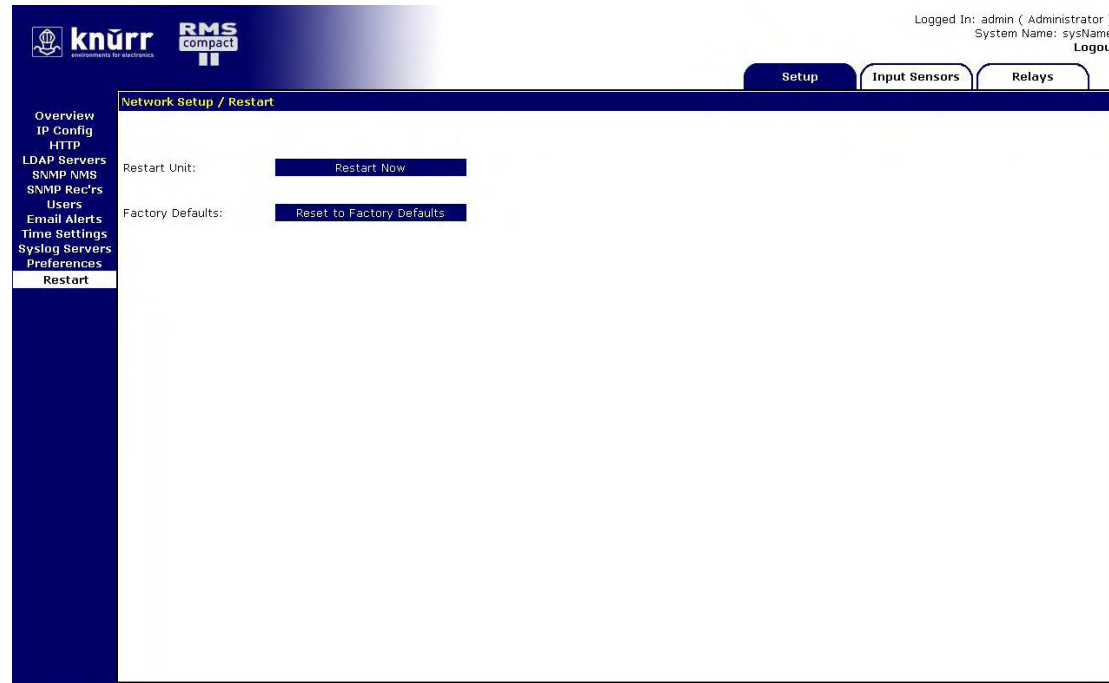

Figure 4-8. Restart

Restart Unit

Restart Now

Selecting '**Restart Now**' commands the unit to reboot. A confirmation prompt is displayed. Rebooting the unit will cause any outstanding configuration changes to come into effect.

Factory Defaults

Reset to Factory Defaults

Selecting 'Reset to Factory Defaults' instructs the unit to restore factory default settings. A prompt appears for confirmation.

Default IP address settings will not come into effect until the unit is rebooted.

This behaviour allows a user to reset a unit to defaults without losing communications. The correct IP address can then be entered on the IP Setup page before the unit is rebooted with the '**Restart Now**' button.

Input Sensors – Status

The Input Sensors status page presents an overview of the RMS Compact II input ports.

Input channel number, name, type of input sensor, status, current readings and thresholds can all be seen at a glance here.

knürr environments for electronics | RMS compact II | Logged In: admin (Administrator) System Name: sysName Logout

Setup | **Input Sensors** | Relays

Input Sensors / Status

Information from connected input sensors is presented here.

Channel	Type	Detected	Status	Value	Limits					
					UC	UW	LW	LC	↑	↓
1: Input 01	Auto Detect	None	Fault	---	N/A	N/A	N/A	N/A	N/A	N/A
2: Input 02	Auto Detect	None	Fault	---	N/A	N/A	N/A	N/A	N/A	N/A
3: Input 03	Auto Detect	None	Fault	---	N/A	N/A	N/A	N/A	N/A	N/A
4: Input 04	Auto Detect	None	Fault	---	N/A	N/A	N/A	N/A	N/A	N/A
5: Input 05	Auto Detect	None	Fault	---	N/A	N/A	N/A	N/A	N/A	N/A
6: Input 06	Auto Detect	None	Fault	---	N/A	N/A	N/A	N/A	N/A	N/A
7: Input 07	Auto Detect	None	Fault	---	N/A	N/A	N/A	N/A	N/A	N/A
8: Input 08	Auto Detect	None	Fault	---	N/A	N/A	N/A	N/A	N/A	N/A
9: Input 09	Auto Detect	None	Fault	---	N/A	N/A	N/A	N/A	N/A	N/A
10: Input 10	Auto Detect	None	Fault	---	N/A	N/A	N/A	N/A	N/A	N/A
11: Input 11	Auto Detect	None	Fault	---	N/A	N/A	N/A	N/A	N/A	N/A
12: Input 12	Auto Detect	None	Fault	---	N/A	N/A	N/A	N/A	N/A	N/A

Figure 4-9. Input Sensor Status.

Status Indicators

Three status indicators are displayed next to input channels to allow quick determination of normal, warning and critical alarm statuses:-

	All thresholds within limits.
	Upper or lower Warning limit reached/exceeded.
	Upper or lower Critical limit reached/exceeded.

Table 4-1. Input Status Indicators.

Input Sensors – Defaults

The Input Sensor Defaults menu allows configuration parameters which relate to input sensors of specific types to be defined and applied to all inputs of that type.

The types of input sensors are:-

**Temperature
Humidity
Open/Close Contacts (digital inputs)**

Logged In: admin (Administrator)
System Name: sysName
Logout

Setup Input Sensors Relays

Input Sensors / Defaults

Defaults settings for Temperature, Humidity, Analogue Voltage and Open/Close Contacts are set here. Individual channels setups that differ from defaults can be configured via the Configure menu.

Temperature Sensors

Calibration Offset: °C
Hysteresis Value: °C

Limits & Traps:	Value:	Trap Enabled:	Repeat Timer:
Upper Control Limit:	<input type="text" value="35.0"/> °C	<input type="checkbox"/> Enabled	<input type="text" value="0"/> Seconds
Upper Warning Limit:	<input type="text" value="30.0"/> °C	<input type="checkbox"/> Enabled	<input type="text" value="0"/> Seconds
Lower Warning Limit:	<input type="text" value="15.0"/> °C	<input type="checkbox"/> Enabled	<input type="text" value="0"/> Seconds
Lower Control Limit:	<input type="text" value="10.0"/> °C	<input type="checkbox"/> Enabled	<input type="text" value="0"/> Seconds
Rising Rate of Change:	<input type="text" value="1.0"/> °C/min	<input type="checkbox"/> Enabled	<input type="text" value="0"/> Seconds
Falling Rate of Change:	<input type="text" value="1.0"/> °C/min	<input type="checkbox"/> Enabled	<input type="text" value="0"/> Seconds

Apply To Temperature Sensors

Humidity Sensors

Analogue Voltages

Open/Close Contacts

Save

Figure 4-10. Input Sensor Defaults with Temperature and Humidity menus.

The defaults that can be specified are described below.

Calibration Offset

The value entered here alters the actual reading of a sensor by the amount specified.

For example, if an Calibration offset of 6 was used and a sensors true reading was 36 the indicated reading used for display and alarm purposes would be 42.

This works in an identical way for both temperature and humidity sensors.

Hysteresis Value

The hysteresis default value to be applied to sensors is specified here. The value specified is an offset from a sensors threshold values.

For example, a hysteresis value of 5 would mean that in the case of an Upper Control Limits alarm the alarm value would have to reduce to 5 below the threshold value before another alarm is issued.

Please see Appendix B: Hysteresis Demystified for detailed information.

Limits and Traps

Default values for sensor alarm thresholds can be specified here. The default settings for alarm threshold traps can also be specified here.

The thresholds that can be set are as follows:-

Upper Control Limit
Upper Warning Limit
Lower Warning Limit
Lower Control Limit

Default trap settings can also be applied for all of these thresholds. With the trap box un-ticked no SNMP alarm traps will be generated even when an alarm condition exists for that threshold.

Repeat Timer

The repeat timer causes alarm traps to be reissued after a specified amount of time if the alarm condition remains present.

Setting the repeat timer to zero (0) will disable the repeat traps.

Rising & Falling Rates of Change

If the rate of change of this value is exceeded, then a trap will be generated - i.e. if the rate of change value is set to 1.0, then if the value read by the sensor goes from 22.0 degrees to 23.0 degrees within 1 minute, then a trap will be generated.

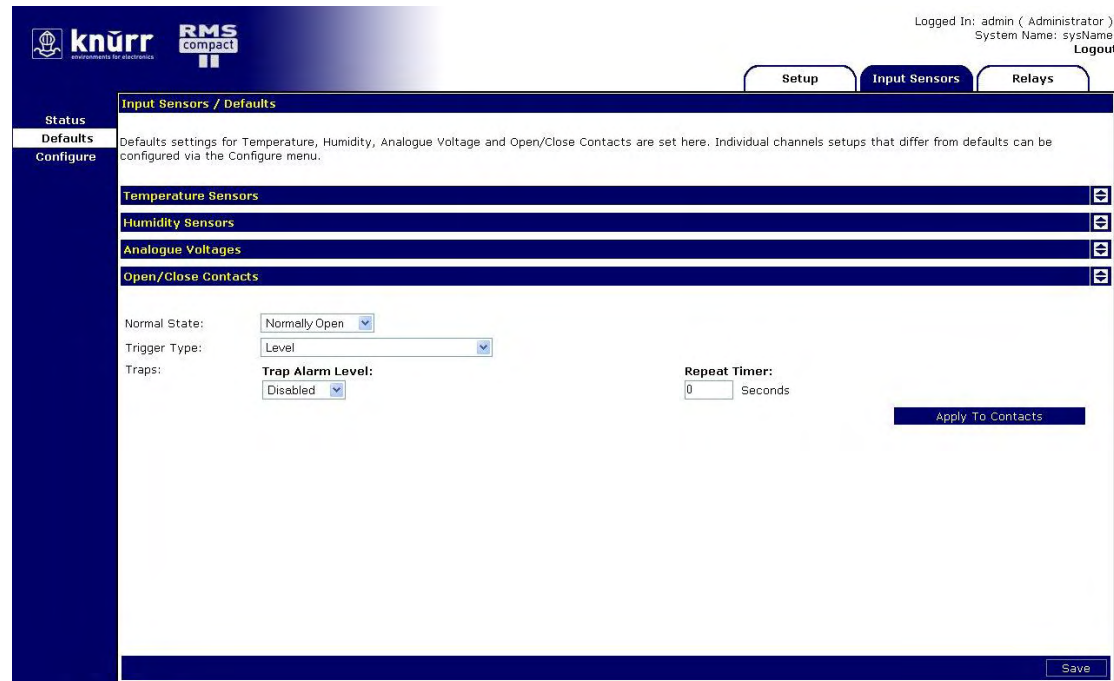

Figure 4-11. Input Sensor Defaults with Open/Close Contacts menu.

The defaults that can be set for Open/Close contacts differ from the Temperature and Humidity settings.

Normal State

Normal state specifies the condition in which a contact is considered to be 'Normal', 'Non-alarmed' state.

Devices such as smoke alarms and air conditioning units often have normally open contacts. In order to receive alarm indications from these types of units setting normally open would cause alarms to be issued when the monitored contact closes.

Setting normally closed in the case of a rack cabinet door would cause an alarm condition when the door was opened.

Trigger Type

Trigger type defaults for Open/Close sensors are specified here.

The three available options for trigger types are:-

Level

Level triggering is the default mode. When an input physically transitions from a Normal to Non-Normal state an alarm will be triggered. However the alarm will only

persist whilst the input remains in a Non-Normal state. When the input returns to a normal state the alarm will be cleared.

Normal to Non-Normal (Positive Edge)

This type of triggering may be used in situations where a momentary type input (eg: shock sensor, PIR etc), is used. Since these types of inputs are momentary any alarm condition which occurs no matter how short will persist until manually cleared.

Positive Edge triggering is used when an alarm is required to persist after an input changes from the Normal state to the Non-Normal state.

Non-Normal to Normal (Negative Edge)

This type of triggering may be used in situations where a momentary type input (eg: shock sensor, PIR etc), is used. Since these types of inputs are momentary any alarm condition which occurs no matter how short will persist until manually cleared.

Negative Edge triggering is used when an alarm is required to persist after an input changes from the Non-Normal to Normal state to the state.

Input Sensors - Configure

Configure allows the individual sensor channels to be configured.

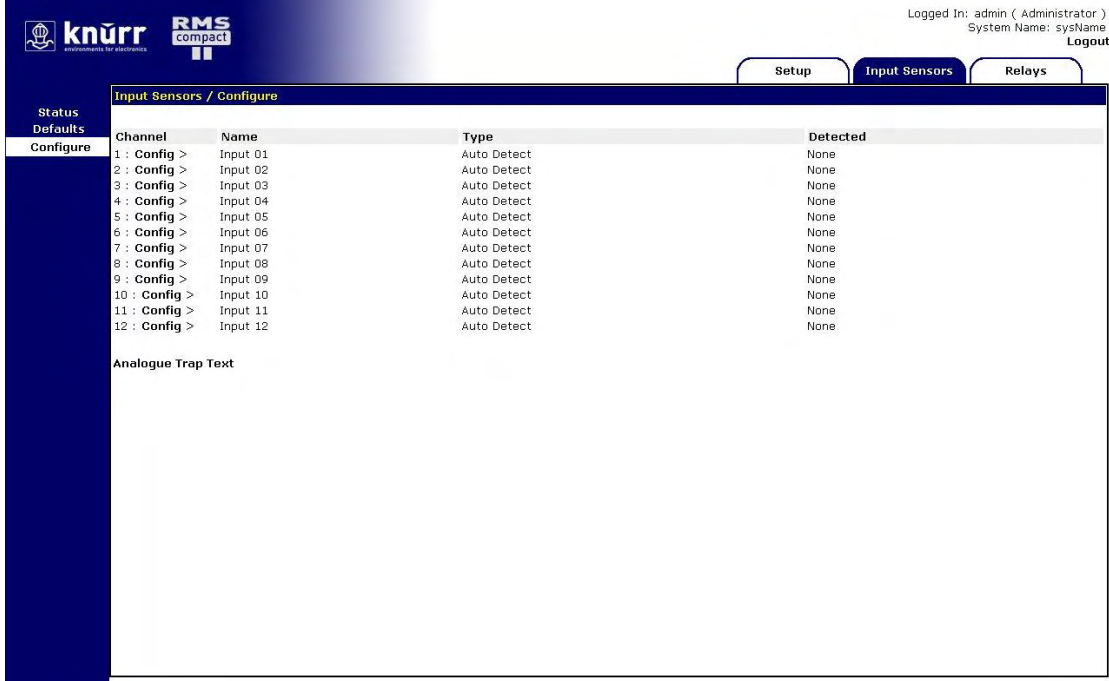

Figure 4-12. Input Sensor Configuration

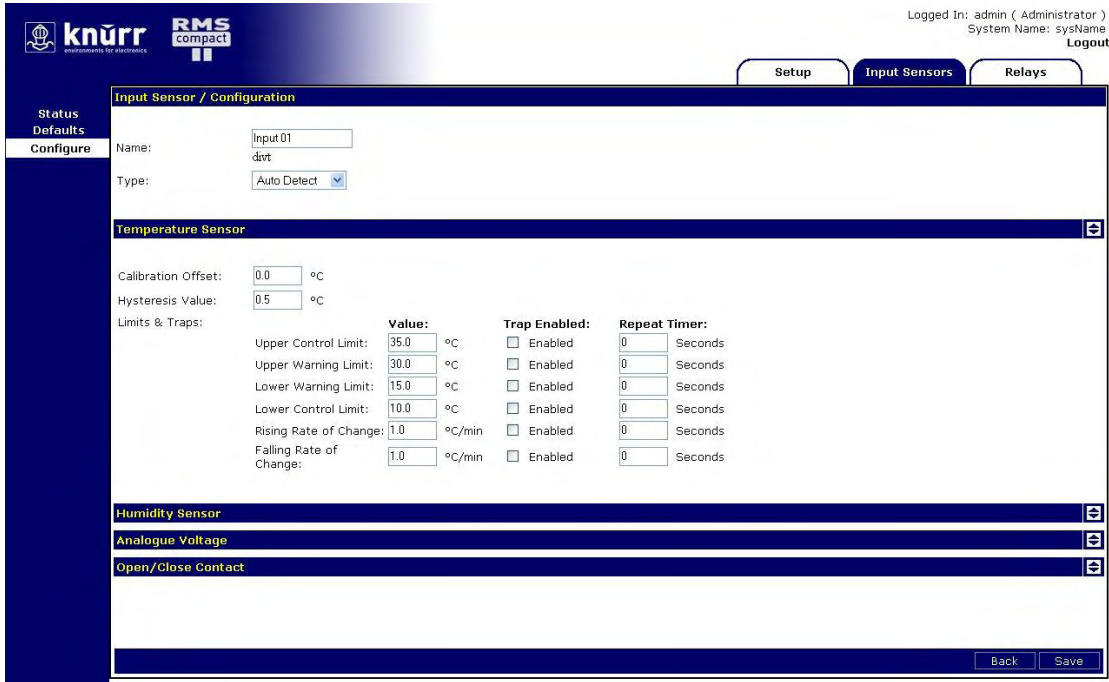

Figure 4-13. Input Sensor Channel Configuration

Selecting the **Config** option will open a detailed configuration page for the selected sensor.

The important difference between the menus presented here and the menus presented on the Defaults page is that settings are applied to individual channels.

The options found in the submenus are identical to those in the Defaults menu, however two additional options can be found.

These are detailed below:-

Name

Sensor channels can be assigned names for ease of identification. Eg: “Server Room Sensor”, “UPS Battery Fail”.

Type

The type of connected sensor is specified here. The sensor channels can be set to auto detect, temperature, humidity, contact or disabled.

Relays – Status

The Relay Status page provides an overview and direct control of the RMS Compact II units 3 output relays.

Logged In: admin (Administrator)
System Name: sysName
Logout

Setup Input Sensors Relays

Relays / Status

Information from connected relays is presented here.

Relay	Normal State	Logic Controlled	Current State	CONTROL		
1: Relay_1	Not Active	-	Not Active	[Activate]	[DeActivate]	[Use Logic]
2: Relay_2	Not Active	-	Not Active	[Activate]	[DeActivate]	[Use Logic]
3: Relay_3	Not Active	-	Not Active	[Activate]	[DeActivate]	[Use Logic]
4: Relay_4 (V)	Not Active	-	Not Active	[Activate]	[DeActivate]	[Use Logic]
5: Relay_5 (V)	Not Active	-	Not Active	[Activate]	[DeActivate]	[Use Logic]
6: Relay_6 (V)	Not Active	-	Not Active	[Activate]	[DeActivate]	[Use Logic]
7: Relay_7 (V)	Not Active	-	Not Active	[Activate]	[DeActivate]	[Use Logic]
8: Relay_8 (V)	Not Active	-	Not Active	[Activate]	[DeActivate]	[Use Logic]
9: Relay_9 (V)	Not Active	-	Not Active	[Activate]	[DeActivate]	[Use Logic]
10: Relay_10 (V)	Not Active	-	Not Active	[Activate]	[DeActivate]	[Use Logic]
11: Relay_11 (V)	Not Active	-	Not Active	[Activate]	[DeActivate]	[Use Logic]
12: Relay_12 (V)	Not Active	-	Not Active	[Activate]	[DeActivate]	[Use Logic]
13: Relay_13 (V)	Not Active	-	Not Active	[Activate]	[DeActivate]	[Use Logic]
14: Relay_14 (V)	Not Active	-	Not Active	[Activate]	[DeActivate]	[Use Logic]
15: Relay_15 (V)	Not Active	-	Not Active	[Activate]	[DeActivate]	[Use Logic]
16: Relay_16 (V)	Not Active	-	Not Active	[Activate]	[DeActivate]	[Use Logic]
17: Relay_17 (V)	Not Active	-	Not Active	[Activate]	[DeActivate]	[Use Logic]
18: Relay_18 (V)	Not Active	-	Not Active	[Activate]	[DeActivate]	[Use Logic]

V = virtual, no physical relay present

Figure 4-14. Relay Status

Control

Activate

Activate commands the selected relay to energise.

Deactivate

Deactivate commands the selected relay to de-energise.

Use Logic

Commands the selected relay into 'Logic controlled' mode. In logic controlled mode the activation and deactivation is governed by any configured and enabled logic.

See **Section** "Relay – Configure" for further information and configuration examples.

Relays – Configure

Relay and logic configuration is performed via two pages.

Logged In: admin (Administrator)
System Name: sysName
Logout

Setup Input Sensors Relays

Relays / Configure

Relay	Name	Normal State	SNMP Traps		Logic	
			Trap Alarm Level	Repeat Timer (Seconds)	Controlled	Configure
1	Relay_1	Not Active	Disabled	0	<input type="checkbox"/>	Config 1 >
2	Relay_2	Not Active	Disabled	0	<input type="checkbox"/>	Config 2 >
3	Relay_3	Not Active	Disabled	0	<input type="checkbox"/>	Config 3 >
4 (V)	Relay_4	Not Active	Disabled	0	<input type="checkbox"/>	Config 4 >
5 (V)	Relay_5	Not Active	Disabled	0	<input type="checkbox"/>	Config 5 >
6 (V)	Relay_6	Not Active	Disabled	0	<input type="checkbox"/>	Config 6 >
7 (V)	Relay_7	Not Active	Disabled	0	<input type="checkbox"/>	Config 7 >
8 (V)	Relay_8	Not Active	Disabled	0	<input type="checkbox"/>	Config 8 >
9 (V)	Relay_9	Not Active	Disabled	0	<input type="checkbox"/>	Config 9 >
10 (V)	Relay_10	Not Active	Disabled	0	<input type="checkbox"/>	Config 10 >
11 (V)	Relay_11	Not Active	Disabled	0	<input type="checkbox"/>	Config 11 >
12 (V)	Relay_12	Not Active	Disabled	0	<input type="checkbox"/>	Config 12 >
13 (V)	Relay_13	Not Active	Disabled	0	<input type="checkbox"/>	Config 13 >
14 (V)	Relay_14	Not Active	Disabled	0	<input type="checkbox"/>	Config 14 >
15 (V)	Relay_15	Not Active	Disabled	0	<input type="checkbox"/>	Config 15 >
16 (V)	Relay_16	Not Active	Disabled	0	<input type="checkbox"/>	Config 16 >
17 (V)	Relay_17	Not Active	Disabled	0	<input type="checkbox"/>	Config 17 >
18 (V)	Relay_18	Not Active	Disabled	0	<input type="checkbox"/>	Config 18 >

V = virtual, no physical relay present

Save

Figure 4-15. Relay Configure

Name

Relay output name is specified here. (E.g. Fan_Tray or Door_1).

Normal State

Normal State specifies the ‘normal’ or ‘non-alarm’ state of a relay.

Not Active

Specifies that a output relay in a ‘Not Active’ (‘not-energised’) state is normal.

Active

Specifies that an output relay in an ‘Active’ (‘Energised’) state is normal.

Trap Enabled

Toggles alarm trap generation. An alarm trap will be generated when the relay is in an ‘alarm’ state with this enabled.

Repeat Timer

Specifies an interval in which a trap for an **existing** alarm condition will be regenerated. This will be a duplicate of the original trap. A repeat timer is not necessary in NMS systems employing intelligent trap handling. Setting zero (0) disables repeat traps.

Controlled

This toggle acts as a master control to any logic configured for a relay. When selected **Use Logic** may be enabled on the Status page.

It is only possible to select this option if logic has been specified in the **Relay Specific Configuration** page.

See **Section** “Relay – Configure – Config” for further information and configuration examples.

Virtual Relays 4 – 18 (V)

Relays 4 -18 are virtual relays, i.e. there is no physical relay present (1-3 have an actual relay that can be switched either manually or using the in-built Boolean logic capability). Virtual Relays 4 – 18 can be used for generating traps based on Boolean logic calculations even though a physical relay is not present.

Relays – Configure - Config

Actual Digital Output Relay logic configurations are specified here.

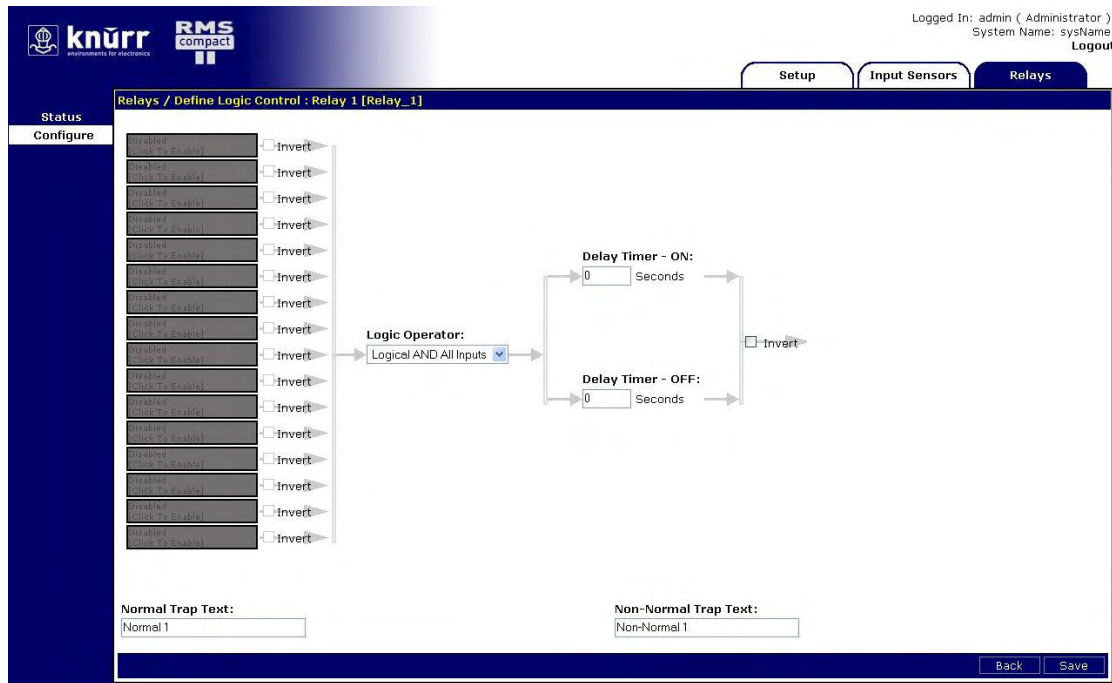

Figure 4-16. Relay Specific Configuration

Input Selection

Inputs into the logic are selected on the left hand side by clicking one of the **Click to Enable** boxes.

Here a sensor type, threshold and channel can be chosen to feed into logic.

Invert

The Invert checkbox allows the logic inversion of an input into the logic.

For example, an upper warning limit is breached, this yields the follow input into logic.

	No Invert	Invert
Threshold breached	1 (Logic Triggering)	0 (Not Logic Triggering)
Threshold within limit	0 (Not Logic Triggering)	1 (Logic Triggering)

Table 4-2. Input Logic Inversion.

Logic Operator

Logic Operator provides options which control the evaluation of inputs to logic.

Logical AND Inputs

Logical AND requires **ALL** of the selected inputs to the logic to be in a triggering state to activate the relay logic.

Logical OR Inputs

Logical OR requires only **ONE** of the selected inputs to be in a triggering state to activate the relay logic.

Delay Timer On

Specifies the time in seconds which must elapse before the logic activates in a situation where it would otherwise activate immediately.

This is useful in a situation where you want a delay to be added before a logic controlled relay is switched on.

If the logic triggering condition clears before the specified time has elapsed then the logic will not activate at all.

Delay Timer Off

Specifies the time in seconds which must elapse before the logic deactivates in a situation where it would otherwise deactivate immediately.

This is useful in a situation where you want a delay to be added before a logic controlled relay is switched off from a current on state.

If the logic triggering condition returns before the specified time has elapsed then the logic will not deactivate at all.

Final Invert

A final invert check box is provided. This allows the final output logical state to the relay to be inverted.

Essentially, any conditions which produce a relay on output will produce the reverse and vice versa.

5 LDAP

RMS Compact II LDAP Overview

The RMS Compact II implements a Lightweight Directory Access Protocol (LDAP) client.

This allows the RMS Compact II unit to authenticate user logins to the Web Management Interface (WMI) using an LDAP Directory.

If LDAP is used for authentication it is first consulted when a user attempts a login. If the user is not found or access is denied by LDAP then the credentials are checked against the RMS Compact II internal user list.

Note! ***Configuration of LDAP is an advanced topic and requires existing knowledge of LDAP function and setup (or access to personnel who do).***

RMS Compact II LDAP Structure

In order for a RMS Compact II unit to successfully authenticate a user for WMI login it needs to be 'pointed' to a specific structure within a directory.

A unit is 'pointed' to this structure within a directory by specifying the **Unit Base DN** on the Network Setup – LDAP page.

The following Organisational Units will need to be created:

RMSCompact2 (this can be named anything)
RMSCompact2Administrators
RMSCompact2Controllers
RMSCompact2Viewers

See **Figure 5-1** (Page 49) for hierarchy details.

The following Groups will need to be created:

RMSCompact2AdminUsers
RMSCompact2ControlUsers
RMSCompact2ViewUsers

Note! ***Groups referred to are groups as found in Active Directory schema. However any implementation which provides a group with a 'members' attribute may function.***

The following figure depicts the RMS Compact II LDAP authentication structure:

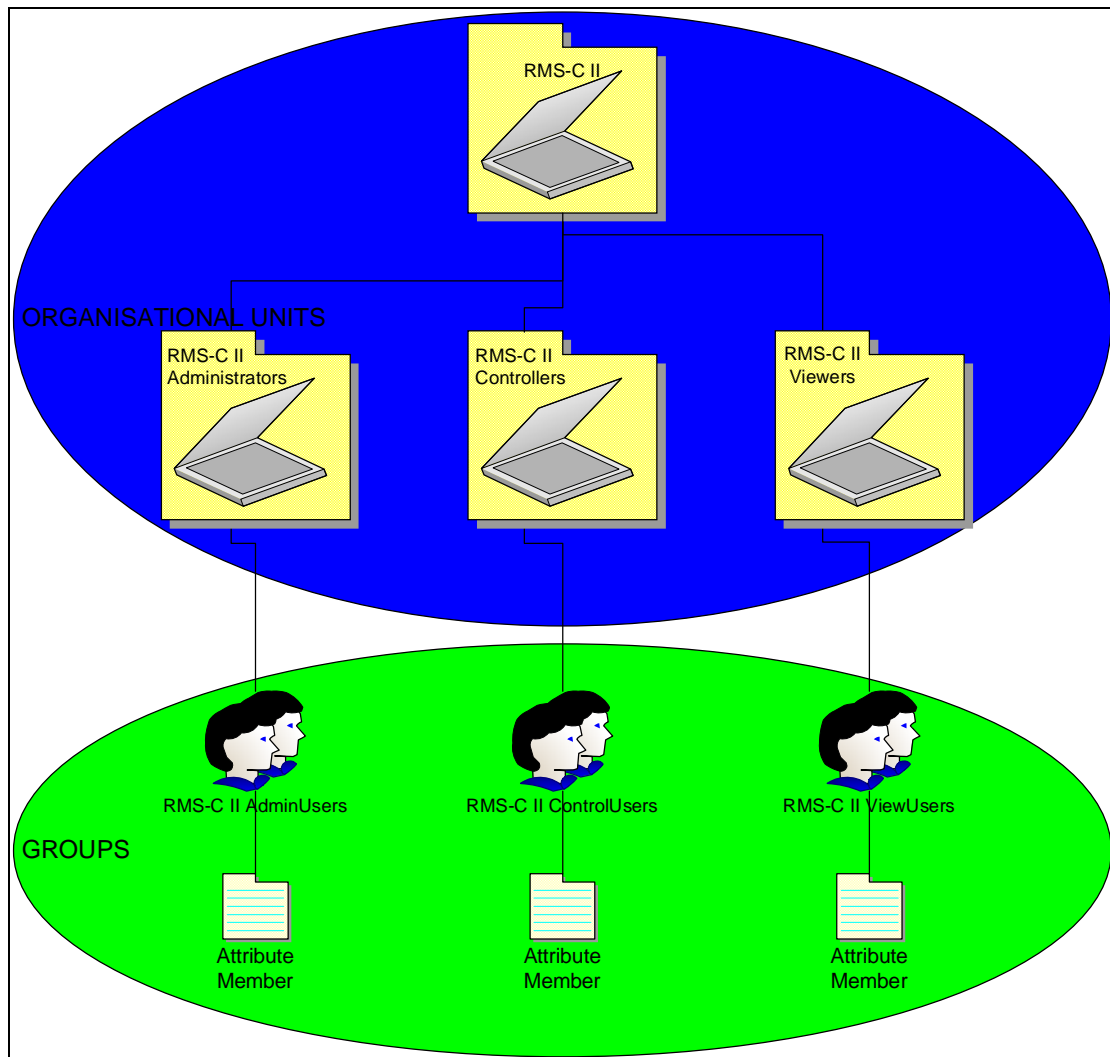

Figure 5-1. LDAP Structure Chart.

Once the required LDAP structure has been created the Distinguished Name (DN) of users should be added to either:

**RMSCompact2AdminUsers
RMSCompact2ControlUsers
RMSCompact2ViewUsers**

Group Membership and Access Level

Membership of these groups grants the following permissions on RMS Compact II units:

RMSCompact2AdminUsers

Users placed into this group will have Admin privileges on RMS Compact II units.

RMSCompact2ControlUsers

Users placed into this group will have Controller privileges on RMS Compact II units.

RMSCompact2ViewUsers

Users placed into this group will have View privileges on RMS Compact II units.

RMS Compact II Unit Configuration

For LDAP authentication to function each RMS Compact II unit requires certain configuration values to be provided.

Logged In: admin (Administrator)
System Name: sysName
Logout

Setup | Input Sensors | Relays

Setup / LDAP Servers

Enabled:

Credential Cache: Minutes (Timeout)

Primary LDAP Server

Display Name:

IP Address:

Unit Base DN:

Users Base DN 1:

Users Base DN 2:

Secondary LDAP Server

Display Name:

IP Address:

Unit Base DN:

Users Base DN 1:

Users Base DN 2:

Save

Figure 5-2. LDAP Setup

The normal steps are listed below:

- 1) If one LDAP server is to be used select **Enabled – Primary**.
- 2) Enter a descriptive name, E.g: AD_Server_1 into **Display Name**.
- 3) Enter the complete DN of the top level OU as seen in **Figure 5-1** above.
- 4) Enter the DN of where users that are members of RMS Compact II access groups can be found in the Directory. These DN's can be entered into **User Base DN 1** and **User Base DN 2**.
- 5) Finally **Save** should be clicked to bring any changes into effect.

6 Troubleshooting

Resetting RMS Compact II to factory default settings

To reset the RMS Compact II unit to factory default perform the following steps:

- 1) Reset the RMS Compact II (by pressing the Reset button or removing and reconnecting the power). Wait **5** Seconds.
- 2) After **5** seconds **press and hold** the Mode button until the red **Alarm** until it extinguishes (approx. 10 seconds).
- 3) Wait 90 seconds for the reset to complete.

The factory default settings will have been restored.

Note! ***This process can be aborted by releasing the mode switch before the alarm light has extinguished.***

The NMS cannot poll the RMS Compact II

- Problem:** The NMS cannot ping or poll the RMS Compact II.
- Solution:** Make sure the network connection to the RMS Compact II is good.
- Solution:** Make sure the cable is in good condition.
- Solution:** Try pinging the RMS Compact II from another computer on the same network segment as the RMS Compact II.
- Solution:** Ensure that the NMS IP Address is in the NMS table of the RMS Compact II.
- Solution:** Ensure that the community string has been set for the NMS via the web management interface.

7 Appendix A: Technical Details

Factory Default Settings

Table 7-1. RMS Compact II Defaults

IP Address:	192.168.0.253
Subnet Mask:	255.255.255.0 (/24)
Default Gateway:	192.168.0.1
Web Management Address:	http://192.168.0.253/
Default username:	admin
Default password	admin

Operating Information

Input Power:	12VDC (300mA ~ 500mA)
Operating Temperature:	0°C to 40°C
Storage Temperature:	-10°C to 70°C
Operating Humidity:	5% to 90% RH
Storage Humidity:	5% to 100% RH

8 Appendix B: Hysteresis Demystified

How Hysteresis works

When a temperature or humidity limit is reached and the relevant limit has its 'OFF to ON Trap' enabled an alarm trap will be issued by the RMS Compact II for this event.

With a zero hysteresis setting the traps will continue to be generated each time the limit is reached.

This may be undesirable in a situation where the temperature or humidity level measure has only reduced by a small amount before rising again and triggering further traps.

The hysteresis function is provided to prevent further alarm traps from being generated until the measured value has fallen to a satisfactory level.

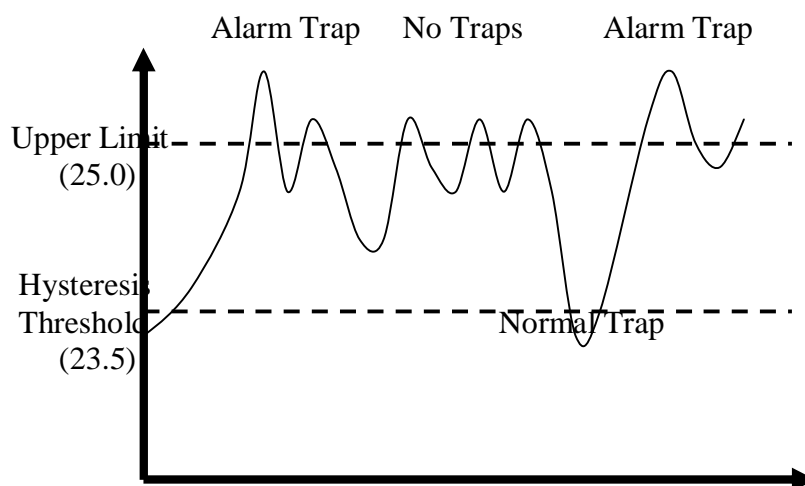

Figure 8-1. Hysteresis chart

As shown in the humidity first rises past its upper warning threshold which generates a trap.

The humidity then reduces slightly but does not reduce to the hysteresis level which is 1.5% RH lower than the alarm (1.5% RH lower as an absolute measured value rather than 1.5% of currently measured value).

Humidity then increases and decreases again. However on the second decrease of humidity the level drops below the hysteresis level. The

Humidity falling below the hysteresis level re-enables alarm traps for the next alarm event. An upper limit of 25 and a hysteresis threshold of 1.5 yield a threshold limit of 23.5.

The humidity level again begins to rise and again exceeds the upper limit, however this time an alarm trap is again generated.

The Hysteresis feature acts on the following Temperature and Humidity thresholds:-

- Upper Control Limit (UCL)
- Lower Control Limit (LCL)
- Upper Warning Limit (UWL)
- Lower Warning Limit (LWL)

The inverse of the above description is true when applied to Temperature and Humidity lower control and warning limits.

As stated above the hysteresis threshold is user configurable using the menu options detailed previously.

9 Appendix C: Custom Sensor Cable

Custom sensor cable for RMS Compact II

Knürr offers custom use 4m sensor cables, which provides autosense (digital or analogue) and allows connect it easily to specific digital or analogue sensors

Digital sensor cable **06.108.224.9**

Analogue sensor cable **06.108.225.9**

The cables have red brown or black wires.

The red wire provides 12V power to the sensor.

The black wire provides ground

The brown wire takes either the analogue or digital signal which shall provide a positive voltage to ground.

		Dry Contact	Analogue Resistor	Analogue Voltage (0..10V)
Red	+12VDC			
Brown	Signal Input			
Black	0VDC (Gnd)			

Application example

IR Movement Detector (06.108.214.9)

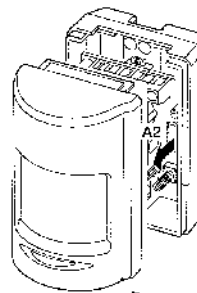
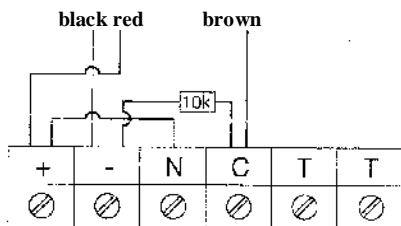

10 Appendix D: Networking Reference

This appendix has two sections: *Reference* and *Troubleshooting*.

Reference

This section discusses SNMP communities, IP addressing, subnet masking, routers and gateways.

Communities

A community is a string of printable ASCII characters that identifies a user group with the same access privileges. For example, a common community name is “public”.

For security purposes, the SNMP agent validates requests before responding. The agent can be configured so that only managers that are members of a community can send requests and receive responses from a particular community.

This prevents unauthorized managers from viewing or changing the configuration of a device.

IP Addresses

Every device on an internetwork must be assigned a unique IP (Internet Protocol) address. An IP address is a 32-bit value comprised of a network ID and a host ID.

The network ID identifies the logical network to which a particular device belongs. The host ID identifies the particular device within the logical network.

IP addresses distinguish devices on an internetwork from one another so that IP packets are properly transmitted.

IP addresses appear in dotted decimal (rather than in binary) notation. Dotted decimal notation divides the 32-bit value into four 8-bit groups, or octets, and separates each octet with a period.

For example, 199.217.132.1 is an IP address in dotted decimal notation.

To accommodate networks of different sizes, the IP address has three divisions - Classes A for large, B for medium, and C for small.

The difference among the network classes is the number of octets reserved for the network ID and the number of octets reserved for the host ID:

<i>Class</i>	<i>Value of First Octet</i>	<i>Network ID</i>	<i>Host ID</i>	<i>Number of Hosts</i>
<i>A</i>	<i>1-126</i>	<i>first octet</i>	<i>last three octets</i>	<i>16,387,064</i>
<i>B</i>	<i>128-191</i>	<i>first two octets</i>	<i>last two octets</i>	<i>64,516</i>
<i>C</i>	<i>192-223</i>	<i>first three octets</i>	<i>last octet</i>	<i>254</i>

Any value between 0 and 255 is valid as a host ID octet except for those values reserved by the IPv4 standard for other purposes:

<i>Value</i>	<i>Purpose</i>
<i>0, 255</i>	<i>Network Number & Broadcast</i>
<i>127</i>	<i>Loopback testing and interprocess communication on local devices</i>
<i>224-254</i>	<i>IGMP multicast and other special protocols</i>

Subnetting and Subnet Masks

Subnetting divides a network address into subnetwork addresses to accommodate more than one physical network on a logical network.

For example: A Class B company has 100 LANs (Local Area Networks) with 100 to 200 nodes on each LAN.

To classify the nodes by its LANs on one main network, this company segments the network address into 100 subnetwork addresses (If the Class B network address is 150.1.x.x, the address can be segmented further from 150.1.1.x through 150.1.100.x.).

A subnet mask is a 32-bit value that distinguishes the network ID from the host ID for different subnetworks on the same logical network.

Like IP addresses, subnet masks consist of four octets in dotted decimal notation.

You can use subnet masks to route and filter the transmission of IP packets among your subnetworks.

The value “255” is assigned to octets that belong to the network ID, and the value “0” is assigned to octets that belong to the host ID.

Network Mask	Routing and Filtering
255.0.0.0	<i>Class A network. First octet defines network number. Final three octets define host address. Valid Class A network numbers are in the range 1 to 126.</i>
255.255.0.0	<i>Class B network. First 2 octets define network number. Final two octets define host address. Valid class B network numbers are in the range 128.0.x.x to 191.255.x.x</i>
255.255.255.0	<i>Class C network. First 3 octets define network number. Final octet defines host address Valid class C network numbers are in the range. 192.0.0.x 223.255.255.x</i>

Gateways

Gateway, also sometimes referred to as a router, is any device with two or more network adapters connecting to different physical networks.

Gateways allow for transmission of IP packets between different networks on an internetwork.