

Gator iDriveZ

Portable Navigation Device (PND)

User Manual



Model 430 / 431 / 433





Dear User,

Thank you for purchasing Gator iDriveZ navigator!

Please read this user manual carefully for proper and safe operation of the device.

- Please use only the original accessories provided by manufacturer in order to avoid unanticipated damage.
- Failure to comply with procedures mentioned in this manual or use of accessories or other peripheral devices which are not intended for use with this device will cause the immediate void of product warranty.
- Please follow local road and traffic conditions to promote safe driving.
- For your safety, do not operate the navigator device while driving.
- Its mandatory for most countries to use hands free or Bluetooth function during driving, please respect local laws.
- All images, illustrations and examples are only for reference, certain specifications may differ from actual product.
- All product specification may subject to change without further notice.
- All Gator products come with **ONE YEAR** Limited Warranty coverage. Please refer to Warranty Card for details.
- For further enquiries, please contact your nearest dealer or local distributor, you may also contact us directly at the following contacts.

Head Office

TDJ Australia Pty. Ltd.

Tel : **61-3-85878898 (Customer Service and Product Repair)**

Email : service@tdj.com.au

Website : www.tdj.com.au



LEGAL NOTICES

COPYRIGHT

- Gator Portable Navigation Device User's Guide issue date: October 2009.
- Gator and the Gator logo are registered trademarks of TDJ Australia Pty Ltd.
- Other products or system names appearing in this document are trademarks or registered trademarks of their respective owners.
- Further, the © or TM symbols are not used in the text.
- Changes may be made periodically to the information in this publication without obligation to notify any person of such revision or changes. Such changes will be incorporated in new edition of this User's Guide or supplementary documents and/or publications.
- No part of this publication may be reproduced, stored in a retrieval system, or transmitted, in any form or by any means, electronic, mechanical, photocopy, recording, or otherwise, without the prior written permission of Gator.

DISCLAIMER AND LIMITATION OF LIABILITY

- Gator and its subsidiaries make no representations or warranties, either expressed or implied, with respect to the contents hereof and specifically disclaims the implied warranties of merchantability or fitness for a particular purpose.
- Gator and its subsidiaries assume no
- responsibility for any damage or loss resulting from the use of this Gator Portable Navigation Device.

IMPORTANT NOTE

- This is an original device with device ID, serial number and relevant information. Please register with your respective regional distributor or with Gator website directly for after sales service.
- The serial number is indicated on the label affixed to your Gator device.
- All registration should include the serial number, device ID, and purchase information.

NOTE: Information in this manual is subject to change without notice.



Contents

Getting started	7
1.1 Packaging	7
1.3 Product Feature	8
1.4 Specifications	9
2 Quick start	11
2.1 Turning on & off	11
2.2 System interface (iDriveZ430)	11
2.3 Using AC car charger	12
2.4 In car installation	12
2.5 Using MicroSD card	13
2.6 Start Navigation	13
3. Operation Details	15
3.1 Navigation functions	15
3.2 Multimedia functions	15
3.2.1 Music player	16
3.2.2 Video Player	18
3.2.3 Picture Viewer	19
3.2.4 Ebook Reader	20
3.3 Phone (For iDriveZ431 Only)	21
3.3.3 Bluetooth	26
3.4 Settings (For iDriveZ 430 & 431)	37
3.4.1 Calibrate touch screen	37
3.4.2 Language settings	38
3.4.3 Backlight settings	38
3.4.4 Volume settings	39
3.4.5 Time & date settings	39



3.4.6 System information	40
4. R-Mount Installation	41
5. Sync GPS Device with PC	43
5.1 Application and functions	43
5.2 Operating Environment.....	43
5.3 Active sync software installation	43
5.4 Using Active Sync software.....	46
6. FAQ	48



Getting started

1.1 Packaging

This product packaging includes the following items. If any defect was found, please contact your local dealer or distributor.

Item	Quantity	Item	Quantity
GPS	1	USB Cable	1
Stylus	1	User manual (CD)	1
AC car charger	1	Warranty card	1
Wind screen mount	1	External TMC module	Optional
Bracket	1	AC charger	Optional
Ear phone	1		

GPS device overview

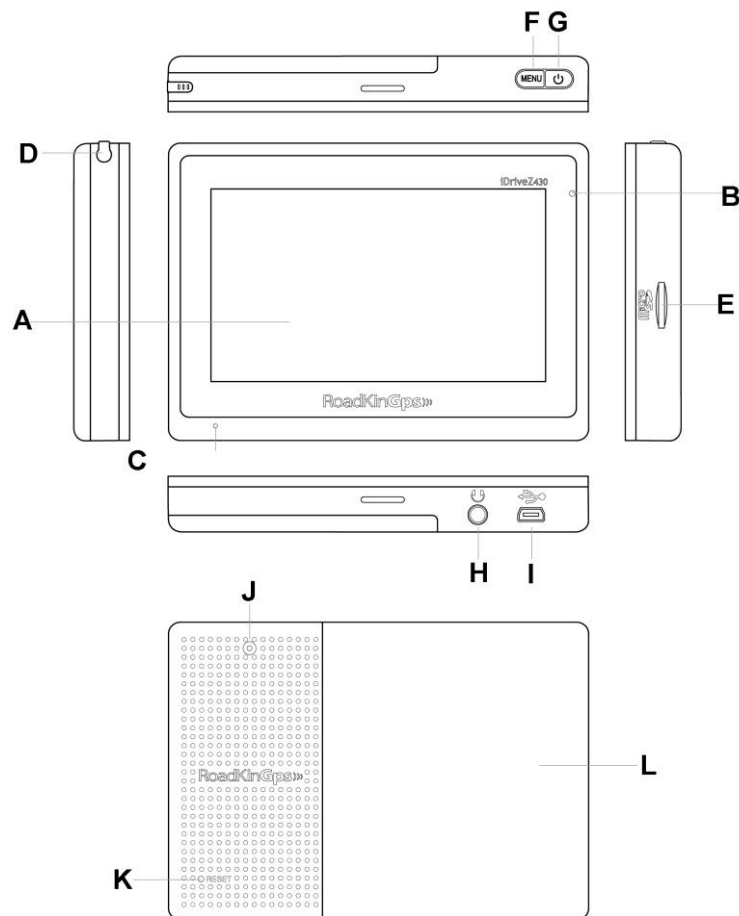



Sign	Item	Description
A	4.3" TFT touch screen	User may choose to use the stylus pen provided (D) or finger to select screen for GPS function.
B	Charging indication light	Red light is in charging mode. Turns Green when fully charged.
C	Microphone	For use on Bluetooth handsfree
D	Stylus	For use on touch screen
E	MicroSD slot	To insert MicroSD card
F	"Menu" button	Shortcut to "Main Menu" screen
G	"Power" button	Hold 1.5 seconds to "Sleep" mode. Press and hold 3 seconds to turn on or off.
H	Ear phone jack	Plug to use external ear phone
I	USB jack	Connect to car / AC charger or USB cable
J	External antenna jack	Connect to external GPS antenna
K	Reset button	To reset device
L	Battery cover	Contain 1500mAhLi-Polymer battery

1.3 Product Feature

- ◆ **Bluetooth & Hands free** : Build in Bluetooth function enables hands free operation and phone calling.
- ◆ **Accurate Navigation** : High performance built-in GPS receiver allows fast satellite acquisition and position accuracy during navigation
- ◆ **Touch Screen Control** : 4.3 inch TFT high resolution touch screen monitor with clear and sharp image view, smooth media playback features.
- ◆ **Easy to Operate** : Touch screen feature made easy for user operation
- ◆ **Movie Playback** : Enabling playback of various movie file formats, avi, wmv, asf and mov.
- ◆ **Music Playback** : Support music playback in wma, wav and mid format.
- ◆ **High Acoustic Fidelity** : Built in high fidelity 1.5W speaker with dual channel stereo ear piece jack,.
- ◆ **Photo Viewing** : Support image file viewing in jpeg, bmp, gif, tiff, png and tga format.



- ◆ **Replaceable and Interchangeable Battery** : 1500 mAh lithium polymer battery, with 3-4 hours of operation on full charging.
- ◆ **Expandable Memory** : Using external memory of up to 4gb, MicroSD to store data and/or navigation software.
- ◆ **E-Book Reader** : Support txt file format.
- ◆ **Real-time Road Condition** : Support external TMC function (Traffic Massage Channel) device.

1.4 Specifications

Environment Specifications	
Unit size	120mm(L) x 85mm(W) x 18.4mm(H)
Operating temperature	-10°C to +60°C
Storage temperature	-20°C to +70°C
Operating humidity	45% to 80% RH
Storage humidity	30% to 90% RH

System Specifications	
CPU speed	400MHz
CPU	SAMSUNG S3C2451XH
RAM	DDRII 128MB
ROM	2GB
MicroSD card	Up to 4GB (optional)
Navigation software storage	MicroSD or NAND Flash
OS	WINCE 5.0
Software compiler	ARMV4I
Navigation software	Navigation software

Basic Specifications	
Screen size	4.3
Screen resolution	480 x 272
Sound quality	Dual channel CD quality
Sound output	Dual channel 0.25W/channel, single channel 1.5W/8Ω
Average	1W
Sleep mode power consumption	<20mW
Battery	Interchangeable 3.7V 1500mAH
Battery standby	Normal use 2 hours(low backlight), standby time 200 hours



GPS Hardware Specifications	
Frequency	1.575 GHZ
C/A CODE	1.023 MHZ chip rate
Satellite Channel	20 channels
Tracking sensitivity	-150 dBm
Accuracy	10m, 2D RMS & 5m, 3D RMS, WAAS enable
Acquisition rate	0.1m/s
Data update rate	1HZ
Re-acquisition time	Average 0.1s
Hot start	Less than 3s
Warm start	Average 40s
Cold start	Less than 100 s
Maximum positioning height	18,000m
Maximum rate	515m/s
Acceleration	< 4g
Built-in antenna type	Built-in antenna
Built-in antenna gain rate	-1dBi

Video & Sound Functions Specifications	
File Format	Wmv, Asf, Mov, Wma, Jpg, Bmp, Png, Pcx, Tga, Tif, Gif, Ico, Wbmp, txt
Resolution	480 x 272

TMC Specifications (Optional)	
Signal Frequency	87.5-108.mhz
Signal Receiving Mode	RDS
Connection	External



2 Quick start

2.1 Turning on & off

- 1) Press and hold down "Power" button to turn on the device, it will take about 15 seconds to boot up the system to Main Menu screen.
- 2) Press and hold down "Power" button for 1.5 seconds to turn the system to "Sleep" mode. Press and hold down 3 seconds to turn off on the device.
- 3) When device in "Sleep" mode, press shortly to activate.

[Attention] When the battery is low, device will beep to alert user and turn into "Sleep" mode. If there is no power supply, device will switch off. If device cannot be turn on, please check if the battery is low. Try to connect to power supply to turn on.

2.2 System interface (iDriveZ430)

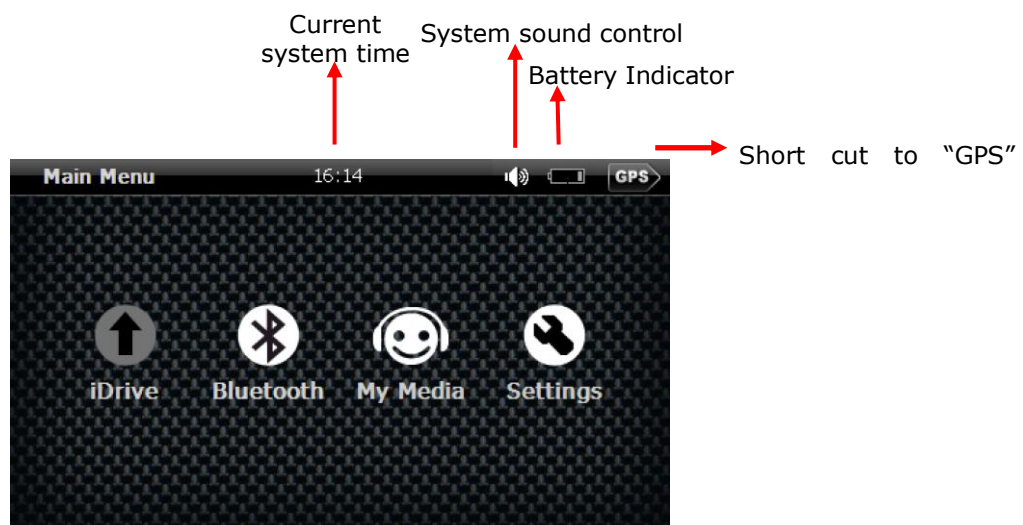

- iDrive** : Navigation software (Map) access
- Bluetooth** : Include "BT Setting", "Phone Book", "Call List", "Message", "Internet", "Dial Pad"
- My Media** : Include "Picture", "Movie", "Music" and "Ebook"
- Settings** : Include "System", "GPS", "Volume", "Video-in", "Time & Date", "Language" and "Backlight"



2.3 Using AC car charger

- 1) For first time use, user should charge the battery at least 8 hours.
- 2) Plug in the Mini-USB port to GPS device and power adapter to power source. When the battery is charging, the indication light will show red, when the battery is fully charged, light will turn green when fully charged. Please do not remove the adapter during charging.

* If charging from completely flat battery, please wait for 1 minute before starting up the system.

[Attention] To ensure the lithium-polymer battery working under best condition, please take note of the followings:

- Do not attempt to charge battery in high temperature environment, (eg. at balcony or under the sun).
- The lithium polymer battery does not need to be discharged, it can be charged at anytime.
- If the device is not in use for prolong period of time, please ensure the battery is charged at least every 2 weeks to avoid the excessive battery discharge which may affect its performance.

2.4 In car installation

- 1) **Using bracket & wind screen mount :** Clip the bracket to the GPS device and attach it to the wind screen mount. Fix the suction on windscreen and ensure it is tightly held onto windscreen (as illustrated).

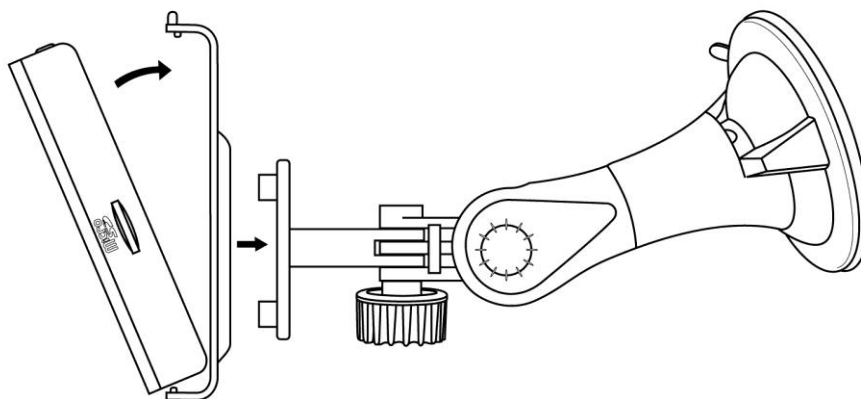



- 2) **Using DC car charger :** Connect the mini-USB to GPS device USB jack and the other side to 12V power outlet in vehicle. To avoid damage from current surge, we suggest you plug in after vehicle engine is started.

2.5 Using MicroSD card

This device has a MicroSD slot for use with MicroSD card. This is use to store navigation software, map data and multimedia files. Insert MicroSD card and press into the slot until it is securely locked. To release, press the card again.

- 1) Please insert MicroSD correctly into the slot at the right side of the device.
- 2) Do not eject MicroSD card during operation (eg. read or copy) to avoid data lost.
- 3) Do not store card in high temperature or in any moist environment.
- 4) Avoid liquid and corrosive material.

2.6 Start Navigation

Please familiarize yourself with the Navigation function of this device. Observe the step by step instruction for easy operation of setting:

Step 1: Setting navigation path

- 1) To access "Setting" Menu, click "Setting" (as shown below).

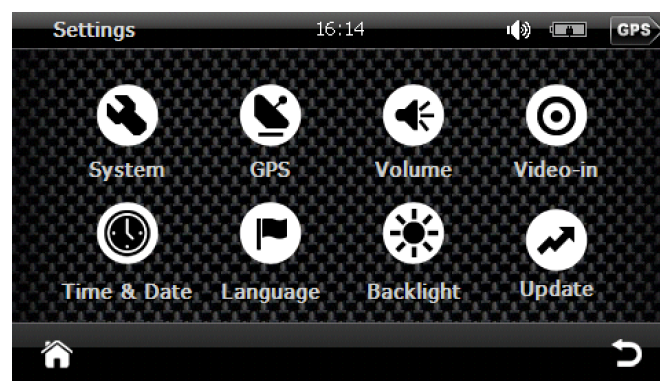



Back to Main Page

Return to previous page

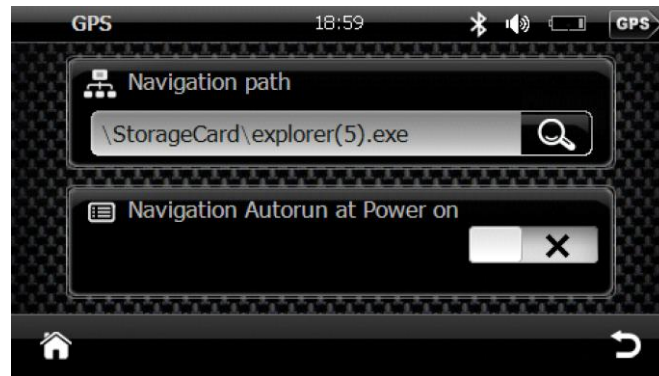

2) To access "navigation software path", click on "GPS" (as shown below)



3) Click  to browse and select the directory.

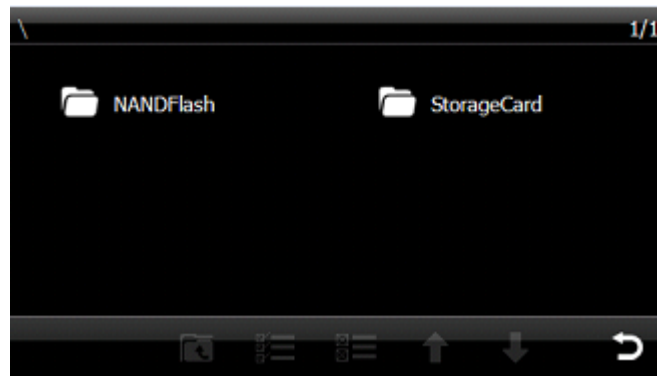

4) Select the navigation software (filename with extension of **.exe**) and double click.

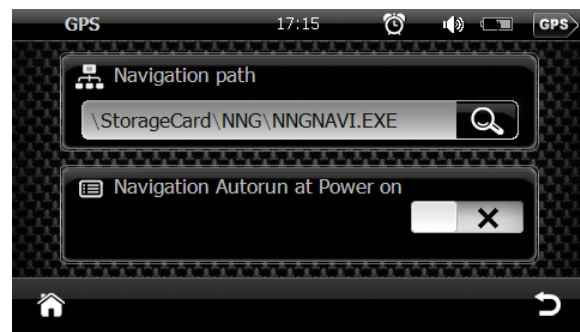
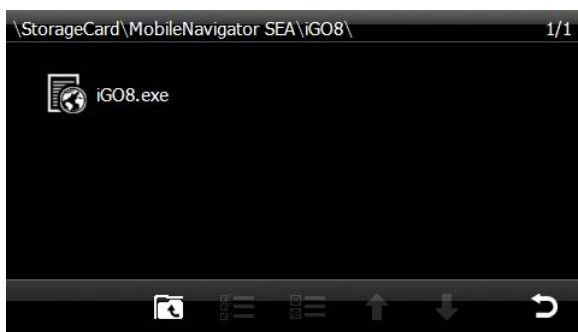

Select your choice by ticking or for "Navigation Autorun at Power on", For , navigation software will auto-start when the device is turned on.

5) Click  to return to "Main Menu".



Step 2: Locating GPS current location

In "Main Menu, click "iDrive" and system will load the navigation software. Navigation software will search for satellites during starting up. The GPS device may take 1-2 minutes depending on the search process.

Example :

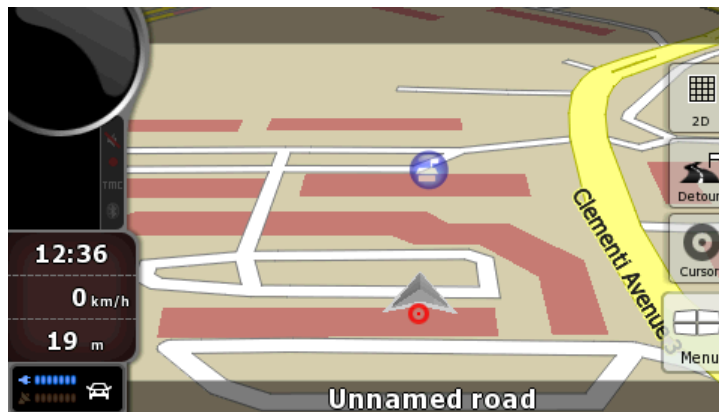

[**Attention**] The navigation software provided by your local vendor or distributor may differ from the picture above. Please refer to your navigation software user manual for further information. The above is only an example

3. Operation Details

3.1 Navigation functions

(please refer to navigation map operation)

3.2 Multimedia functions

Click "My Media" at the "Main Menu".

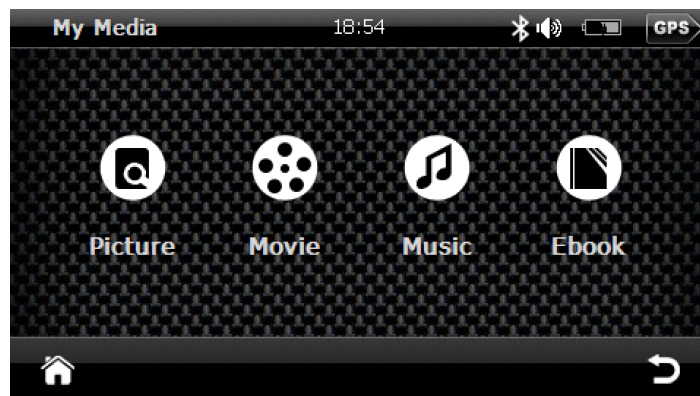



3.2.1 Music player

1) Click on "Music" in "My Media" to activate the music player

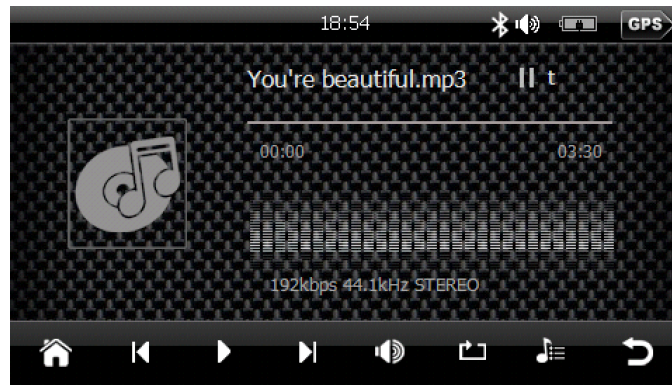



2) **Add music file**

a) When there is no music file in the Music Player directory, the system will list both NANDFlash and StorageCard (MicroSD). Select music files from these directories to add to Music Player.

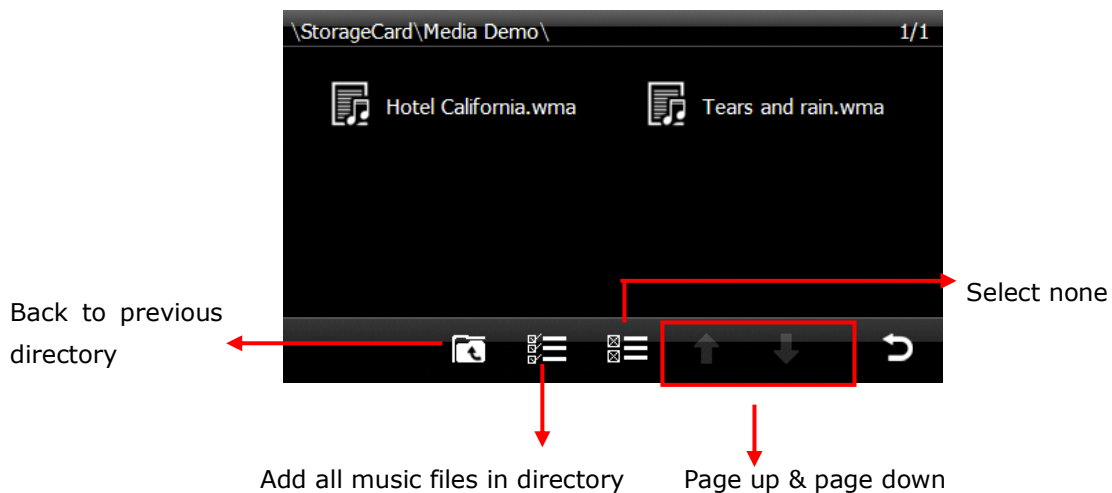

b) Select and add music files:





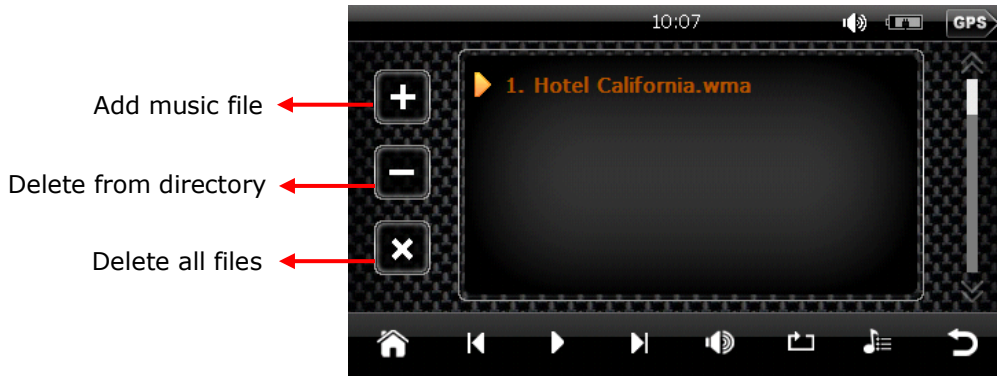

Click  path to select all the music files in the folder and then click  to return back to Music Player. You may add individual music file by clicking on the music file.

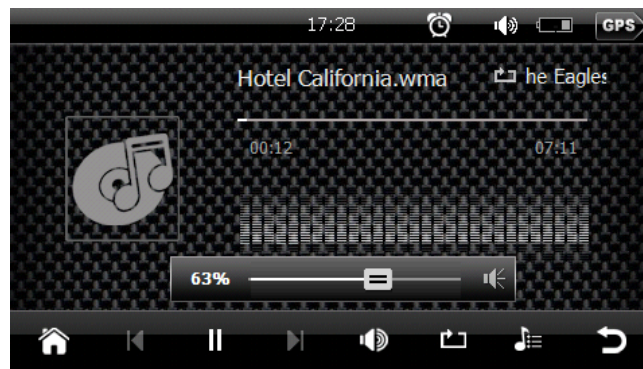











c) Click  or double click to go to Music Player and play the music file. If idle for 5 seconds, music directory interface will jump to Music Player and start to play music files.



d) Click  to play music, click  to pause, click  to slide on sound volume bar  and adjust the volume.

e) Click  to go to Playlist and click  to add music files to playlist.

f) Music Player functions:

Button	Function	Remark	Button	Function	Remark
	Play	Play music		Pause	Pause playing music
	Previous	Play previous music		Shuffle	Shuffle play mode
	Next	Play next music		Loop	Loop play mode
	Mute	Mute player		Playlist	Go to Playlist
	Volume	Adjust volume		Main Menu	Back to Main Menu
	Return	Return to previous menu			

[Attention] System will disable the speaker when ear phone is plugged in.



3) Display Lyrics:

This device is able to display lyrics while playing music files.

- ✧ Download song and lyrics to MicroSD and place in the same directory.
- ✧ Song filename and lyrics filename must be identical.
- ✧ Other instructions are same as above.

3.2.2 Video Player



1) Access Video Player: In "My Media" menu, click on "Movie".



2) Add video file:

- a) System will open NANDFlash and MicroSD directory if there is no video file in playlist.
- b) The instruction to add video files is same as adding music files.
- c) Click  to access the playlist.









Click  to add video to playlist or click  to add all videos to playlist.

d) Click  to play video.

e) Click  to get volume sliding bar  to adjust volume.

3) Video Player functions:

Button	Function	Remark	Button	Function	Remark
	Play	Play video		Mute	Mute player
	Pause	Pause video		Volume	Adjust volume
	Previous	Play previous video		Full screen	See full screen video
	Next	Play next video		Playlist	Video Playlist
	Back	Back to previous menu		Main Menu	Back to Main Menu

3.2.3 Picture Viewer

1) In "My Media", click "Picture" to launch Picture Viewer.

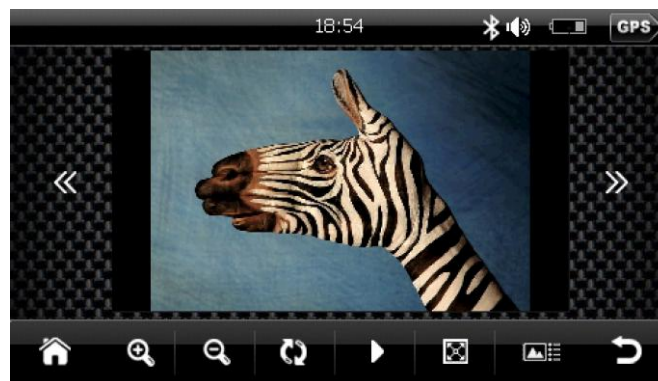

2) Add photo: Click  to picture list and click  to add picture to list.





3) Picture Viewer functions :

Button	Function	Remark	Button	Function	Remark
	Play	Play pictures in slide mode		Next	Next picture
	Zoom in	Zoom in picture		Previous	Previous picture
	Zoom out	Zoom out picture		Full screen	See picture in full screen
	Rotate	Rotate photo 90 degree		Picture list	See picture list
	Back	Return to previous menu		Main Menu	Return to Main Menu

3.2.4 Ebook Reader

1) In "My Media", click "Ebook" to launch Ebook Reader.

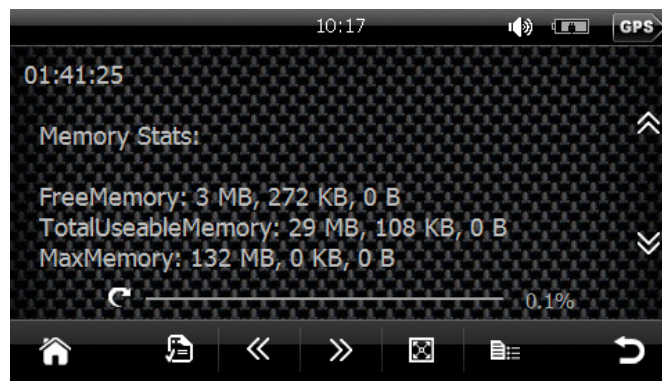





2) Add Ebook: Click to access ebook list and click to add to ebook list.

3) Ebook function :

Button	Function	Remark	Button	Function	Remark
	Bookmark	Go to bookmark page		Previous	Read previous article
	Scroll up	Scroll page up		Next	Read next article
	Scroll down	Scroll page down		Ebook list	See ebook list
	Full screen	View in full screen		Main Menu	Back to Main Menu
	Back	Back to previous menu			

4) Bookmark: Click  to access bookmark of ebook.



Button	Function
	Read selected document
	Save document
	Delete selected document
	Delete all
	Back to Main Menu

3.3 Phone (For iDriveZ431 Only)

In "Main Menu", click "Phone" to access to Bluetooth menu.

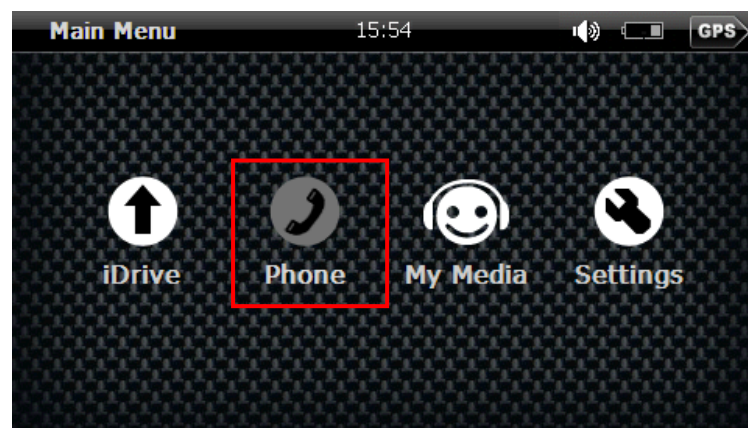

3.3.1 Bluetooth setting

After mobile phone is paired with this device via Bluetooth, you may use this device to make calls, receive calls and hands free calling.



- a) Bluetooth pairing with mobile phone: Activate Bluetooth: Go to "Phone" menu and click "Settings" to access Bluetooth menu.

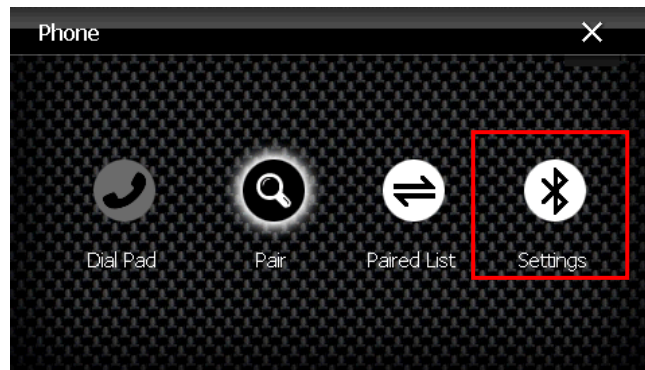



- b) Bluetooth setting: In "Phone" Menu, click "Settings".



Bluetooth on standby: Click to activate or deactivate Bluetooth on standby. Button shows , it means Bluetooth remains activated in other interface. If not, Bluetooth connection will be disconnected when exit "Bluetooth" menu.

Auto answer: Click to activate auto answer mode.



IN setting: Click  to open small keyboard and set PIN. Input PIN using the small keyboard, click  to delete input numbers and click  to complete PIN setting and return to previous menu.



2) Pairing with mobile phone

- a) Activate Bluetooth device search function of your mobile phone to pair with this device.

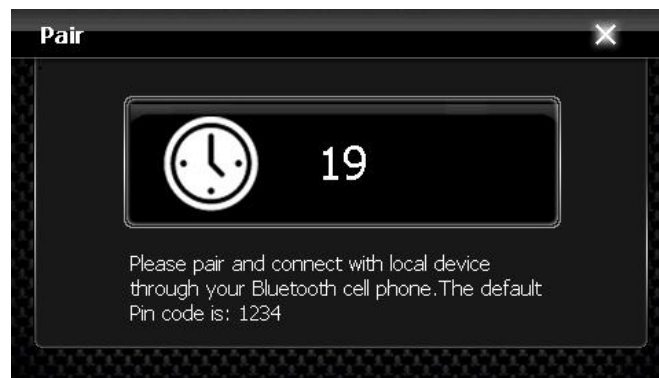

- b) Input PIN code for pairing (default pairing PIN code is 1234). Pairing method for different mobile phone may vary, please refer to your mobile phone manual.
- c) "Dial Pad" icon in "Bluetooth" menu will bright up and "Connect" icon will dim down.

3) Check pairing list: In “Bluetooth” menu, click “Paired List” to see list of paired mobile devices.

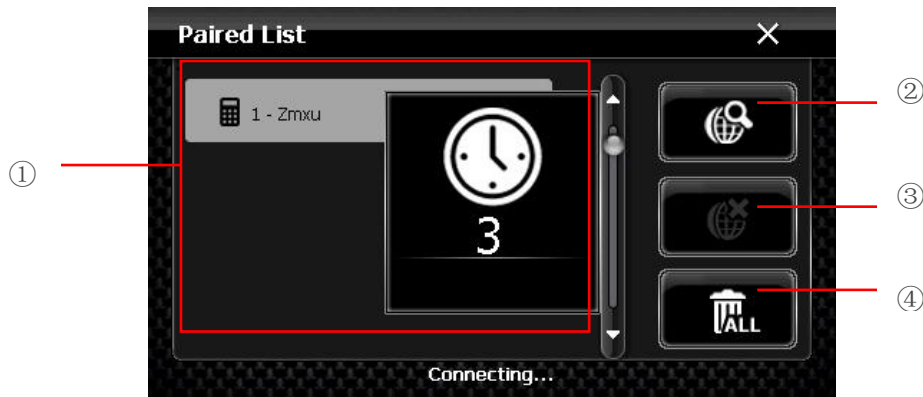

1. List of mobile devices which were previously paired with GPS device using Bluetooth.
2. Click your mobile device is in the list to select for Bluetooth connection. (Note: Bluetooth function in mobile device must be turn-on)
3. Click to disconnect connectivity between GPS device and mobile device.
4. Delete the list of paired devices.

2. Handsfree operation

1) Making call:

After pairing completes, click “Dial Pad” in “Bluetooth” mode to make call.

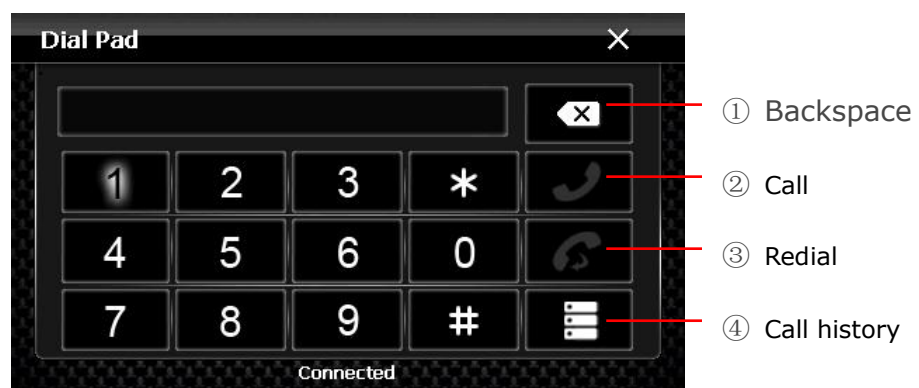

2) **During call:**

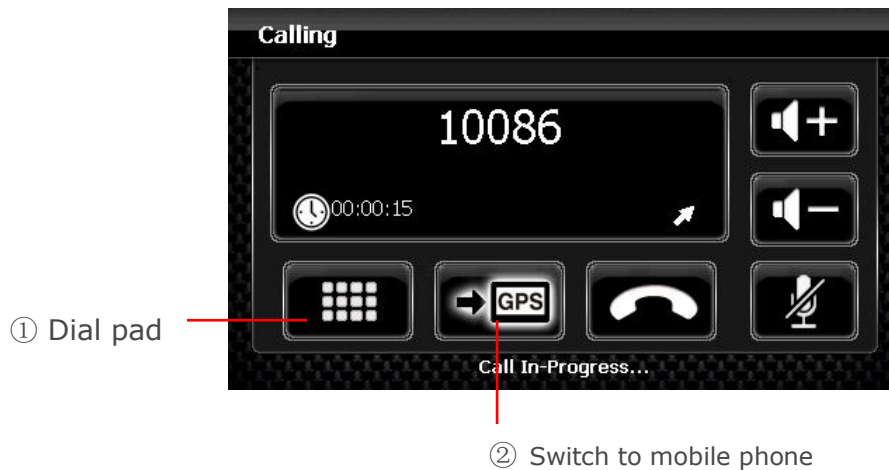

During call, you may operate the following:

- ✓ If require to input numbers, e.g. extension number, click ① for dial pad.

Eg:



- ✓ **Adjust volume: Click on + or - to increase or decrease call volume. Click speaker button to turn on or off.**
- ✓ **Switch between GPS device and mobile phone: Click ② to switch call to mobile phone and click again to switch back to GPS device.**
- ✓ Click to end call.

3) Check call list:

In "Dial Pad" menu, click  to see the call list.

(The call list is retrieved from your mobile phone connected to this device via Bluetooth, this function may vary or not supported by certain mobile phones.)

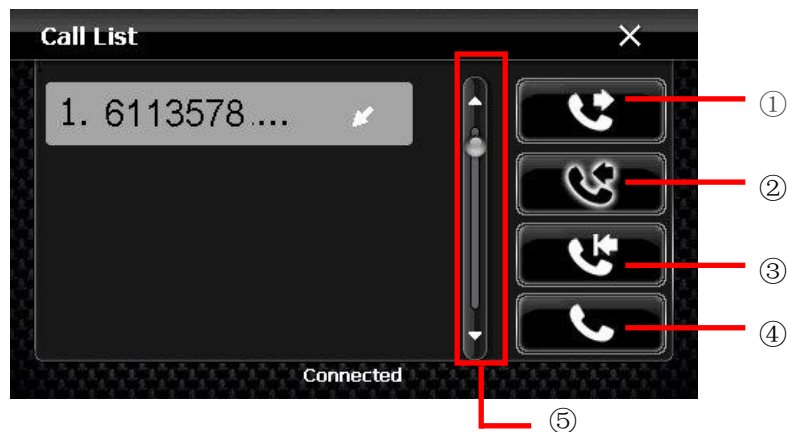

In default, call list display all the call history, you may click on the right panel to check incoming calls, missed calls and outgoing calls.

1. Outgoing calls
2. Incoming calls
3. Missed calls
4. Click on phone number in Call List and click this button to make call
5. Scroll up and down

(Applicable for iDriveZ430 model with GPRS (DUN) function only)

3.3.3 Bluetooth

In "Main Menu", click "Bluetooth" to access to Bluetooth menu.

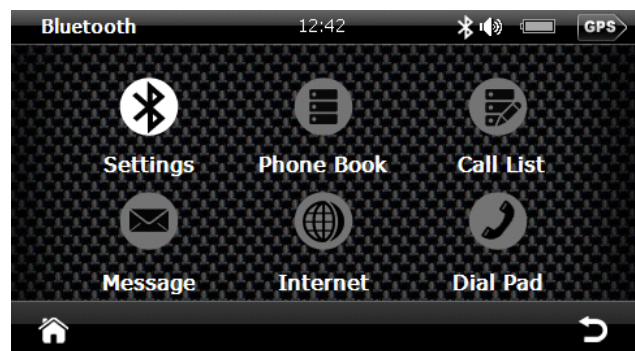
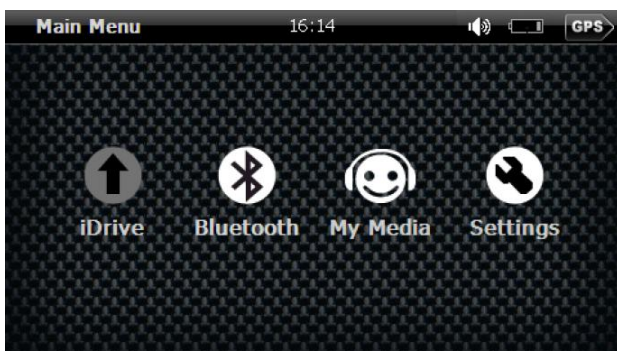

3.3.3.1 Bluetooth Settings

In "Bluetooth", click "Settings" to access to Bluetooth settings menu

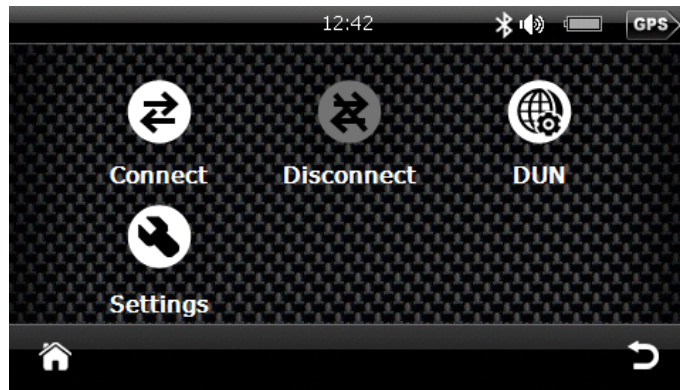

In Bluetooth settings menu, click "Connect" &  to search for the mobile phone to pair.

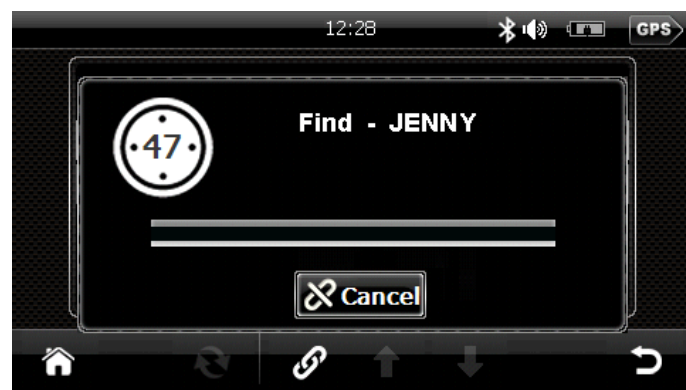
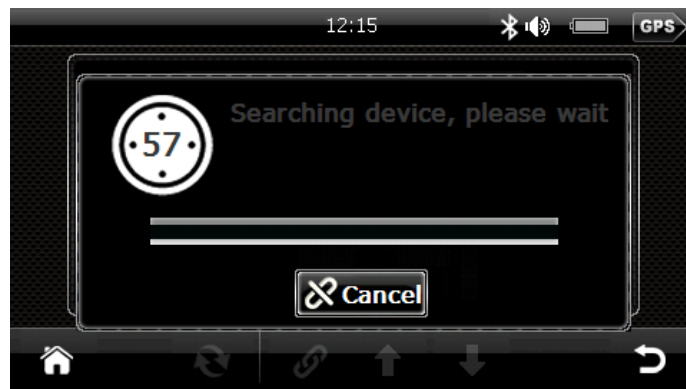



Select the mobile device to be connected, click  to pair, input PIN code for pairing (default pairing PIN code : **1234**). Pairing method for different mobile phone may vary, please refer to your mobile phone manual.

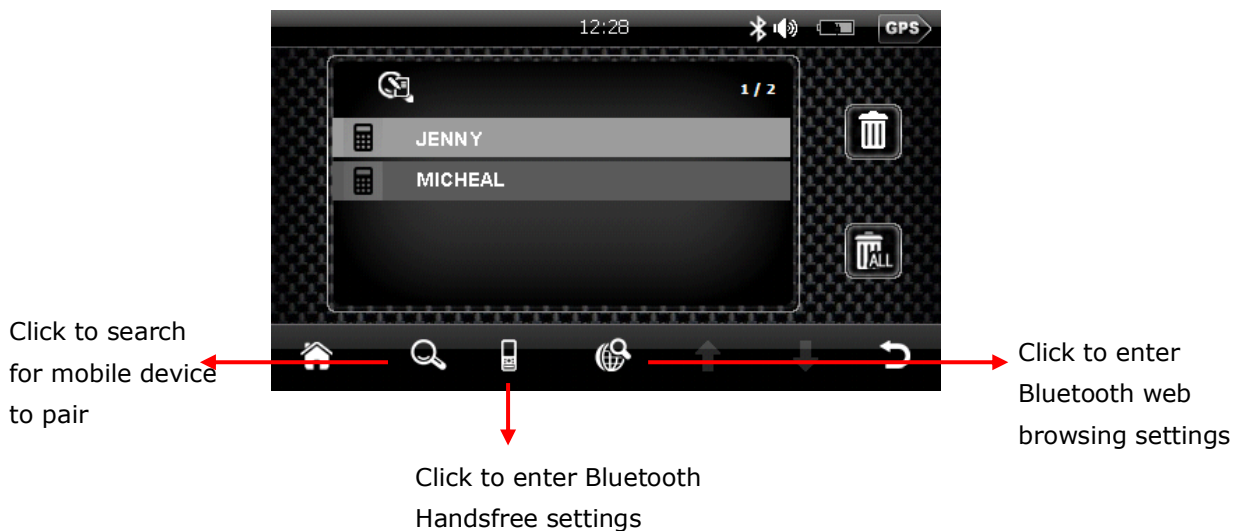

2. Handsfree operation

Making call:

- After pairing completes, click "Dial Pad" in "Bluetooth" mode to make call:



Click  to call





Calling:



Click to adjust the volume

Click to switch on and off the speaker

Click  to switch call to GPS and click again to switch back to mobile phone,

 the icon will change to .

Click  button, numbers dial pad appears to allow for calling of extension number:





- Receiving call



Click to answer Click to hang up



Click to switch call to mobile phone or GPS

Click to switch on and off the speaker

- Phonebook

In Bluetooth menu, click "Phone book" to browse mobile phone contacts:



- Call List

In Bluetooth menu, click on "Call List" to check the call history.

(The call list is retrieved from your mobile phone connected to this device via Bluetooth, this function may vary or not be supported by certain mobile phones.)

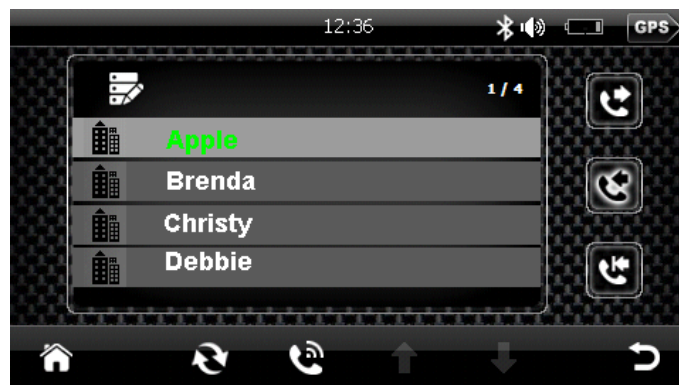



- Message

In Bluetooth menu, click "Message" to enter:

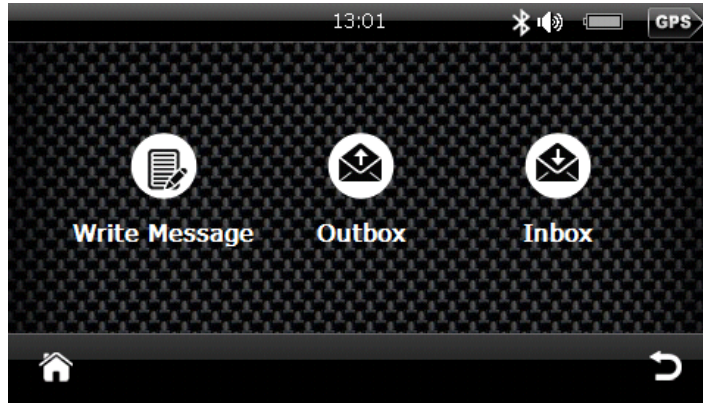

- Write message

Click "Write message" to enter:

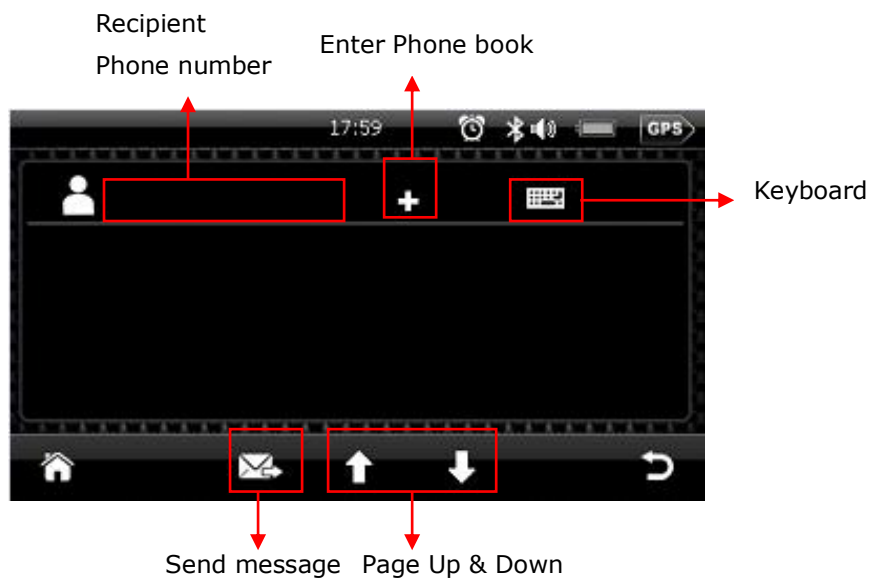

Click "Send message" & "Confirm" to send the message:

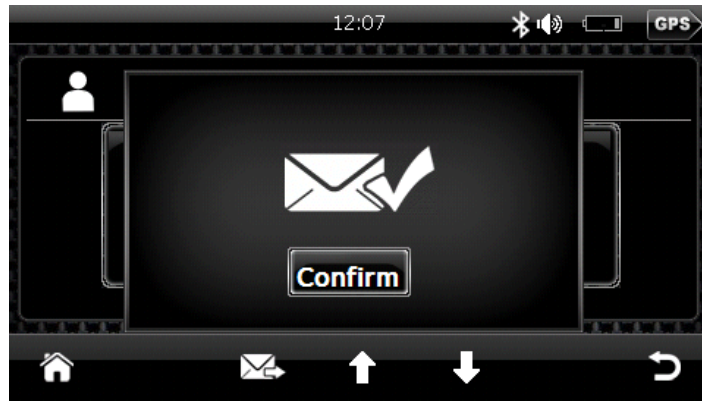

- Outbox

Click "Outbox" to enter and check all sent messages:

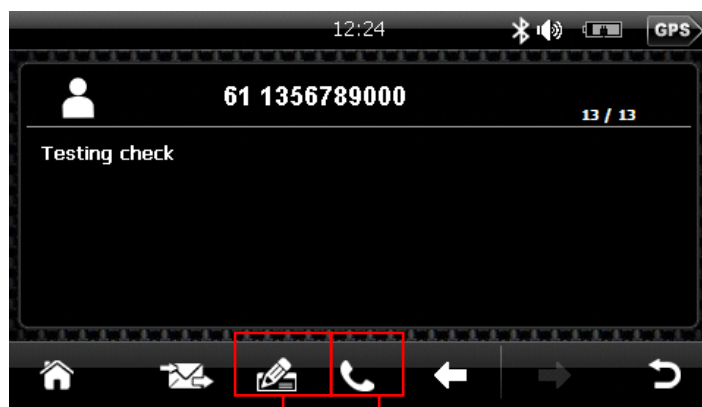

Reply Call contact
message

Click "Reply message" to write message:

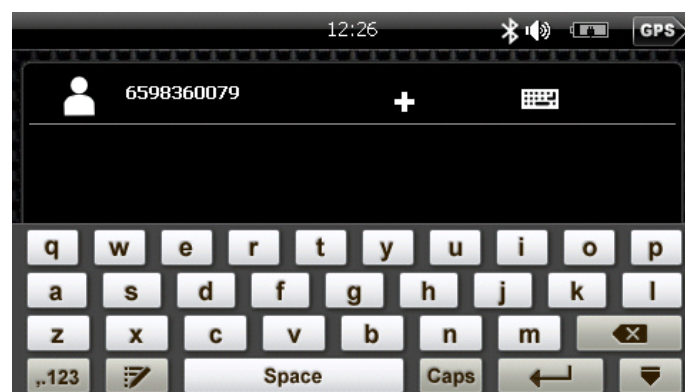



- Inbox

Click "Inbox" to enter:



Click "Contact" to check the message details:

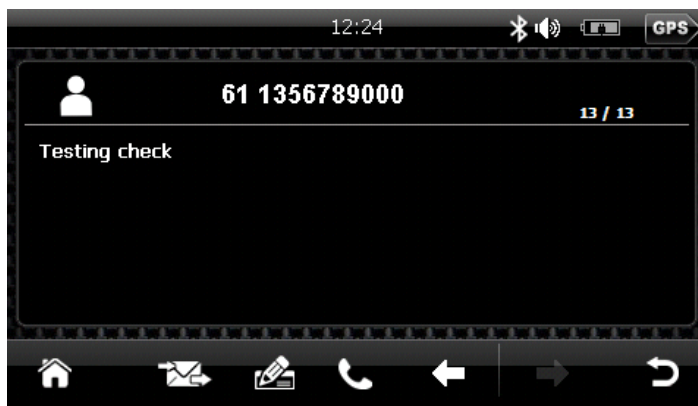

3. Bluetooth Web Browsing Function

In "Bluetooth" menu, click on "Settings" to enter:

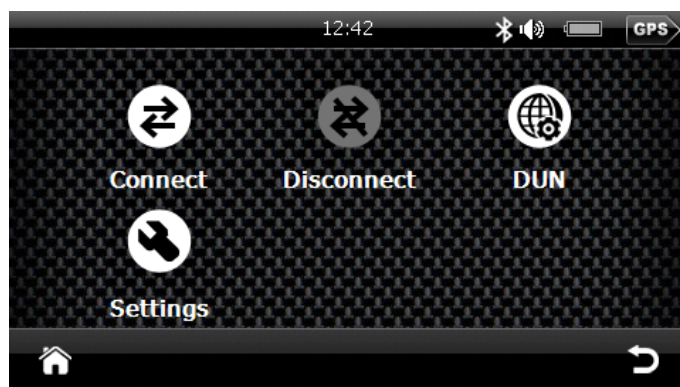



- Click “Connect” to search for mobile phone to pair:



Select the mobile device to be connected, click  to pair, input PIN code for pairing (default pairing PIN code is 1234). Pairing method for different mobile phone may vary, please refer to your mobile phone manual.



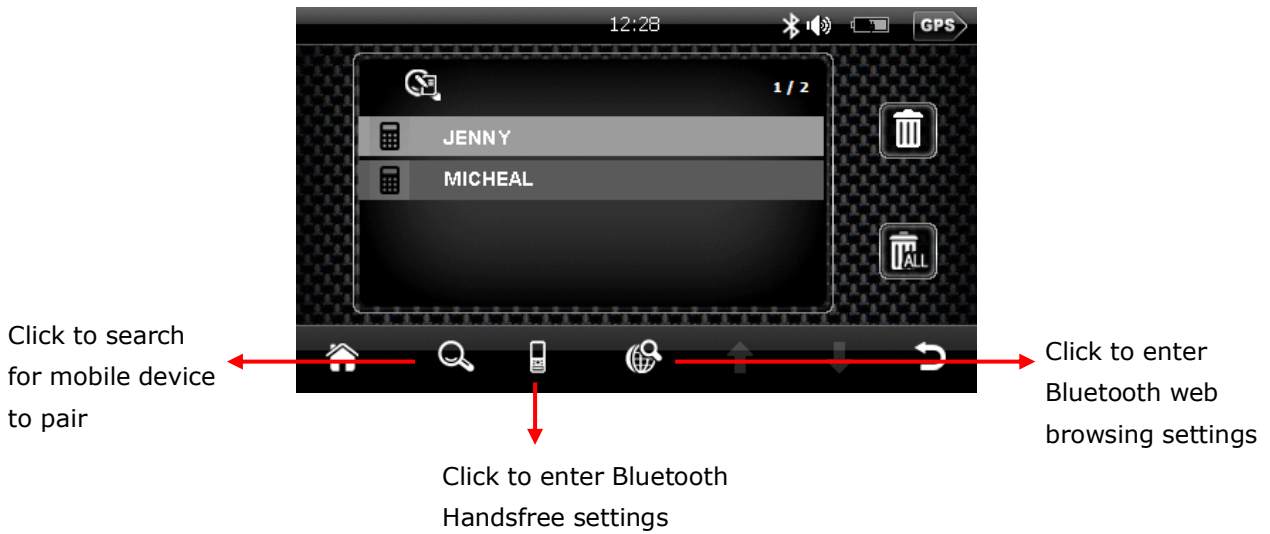

Click Internet Access for web-browsing connection:

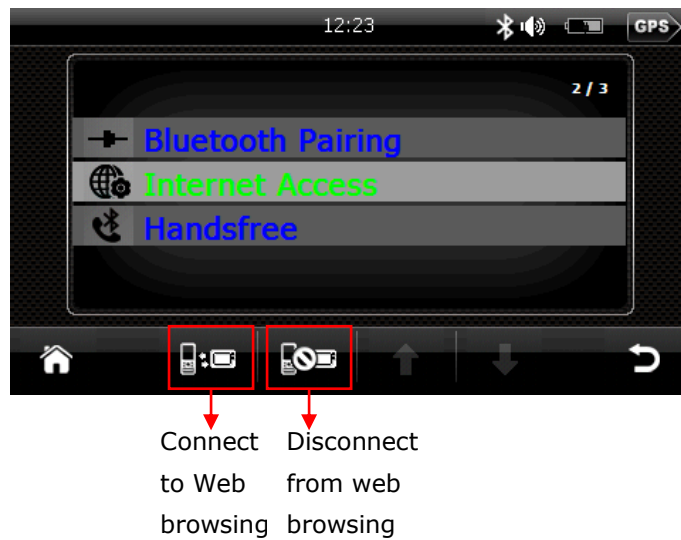



Click "Internet Access", Bluetooth menu appears, click on "Internet" to start web browsing:

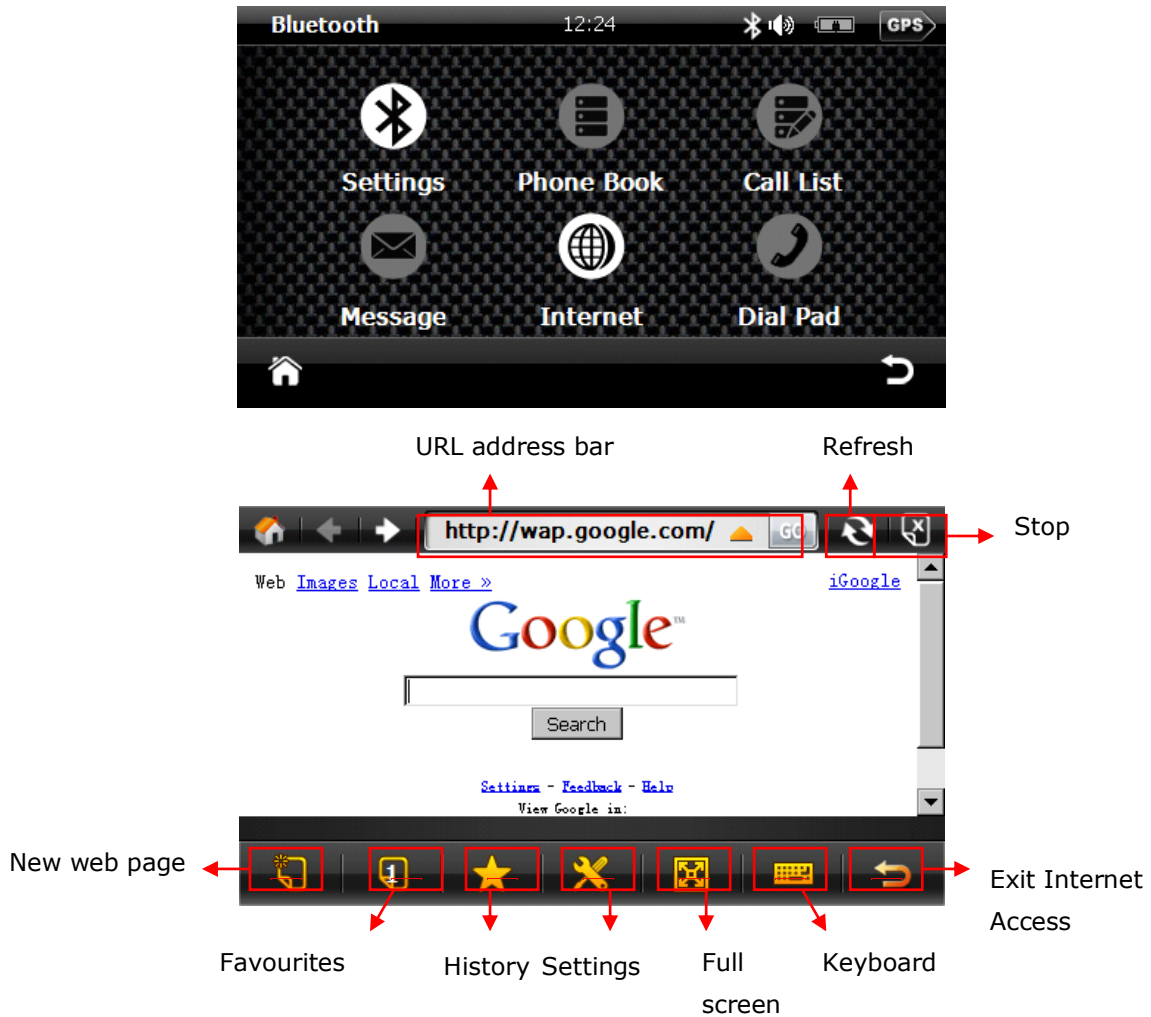



3.4 Settings (For iDriveZ 430 & 431)

Click "Settings" in Main Menu to access setting interface.

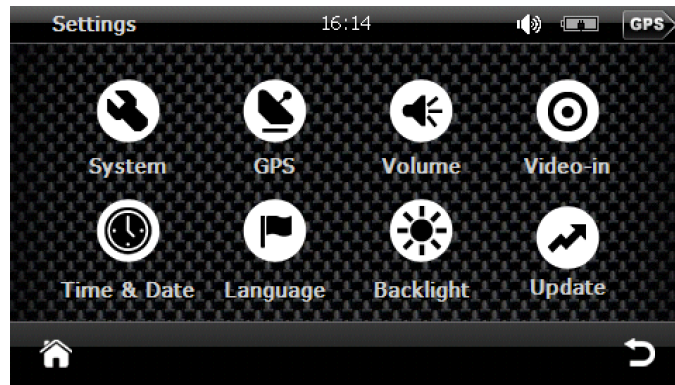

3.4.1 Calibrate touch screen

1) In "Settings" menu, click "System".

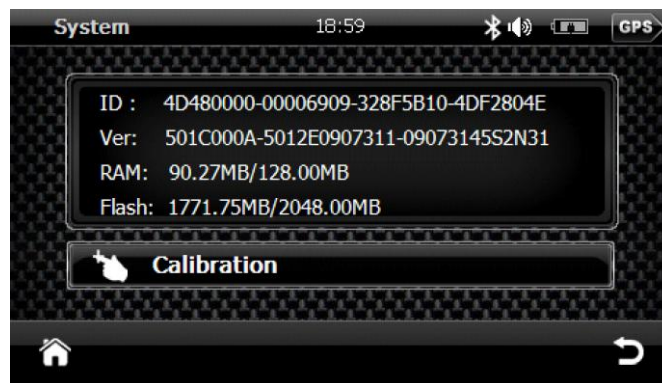

2) Click "Calibration" to calibrate the device touch screen.

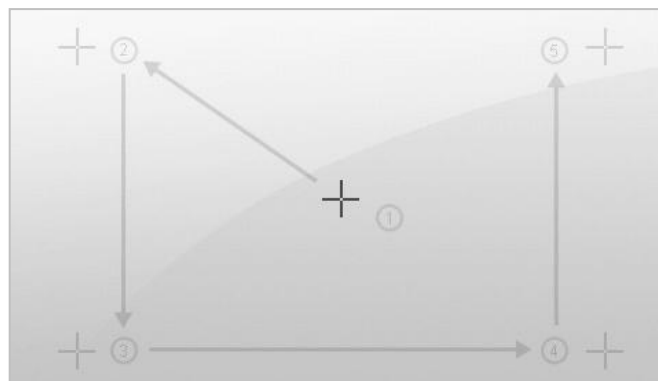



- 3) Click on the cross sign and it will auto-move from position 1 to 5.
- 4) After calibration is unsuccessful, it will return to "System" menu.
- 5) If calibration is successful, the screen will display "OK", then click "OK" to exit. After calibration, device system will save the calibrated settings. Calibration only applies to new system installed.

3.4.2 Language settings





In "Settings" menu, click "Language". Select a language pack and click  to confirm and return to previous menu.

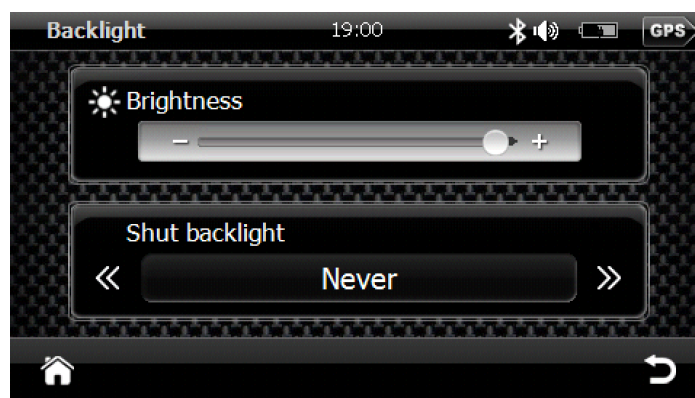

3.4.3 Backlight settings

- 1) In "Settings" menu, click "Backlight" to adjust brightness and set backlight timing.





- 2) Slide the bar to adjust screen brightness ""
- and click  or  to adjust backlight shut time.
- 3) Click  to return to previous menu.

3.4.4 Volume settings

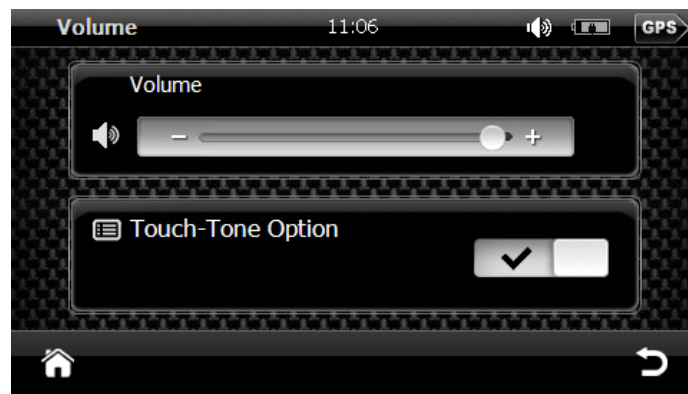
- 1) In "Settings" menu, click "Volume" to adjust system sound volume and set "Touch-tone option". Volume setting can also be accessed by clicking the small speaker icon  on top-right of screen.



- 2) Slide on volume bar  to adjust volume.
- 3) Select  to activate touch tone.
- 4) Click  to return to previous menu.

3.4.5 Time & date settings

- 1) In "Settings" menu, click "Time & Date".

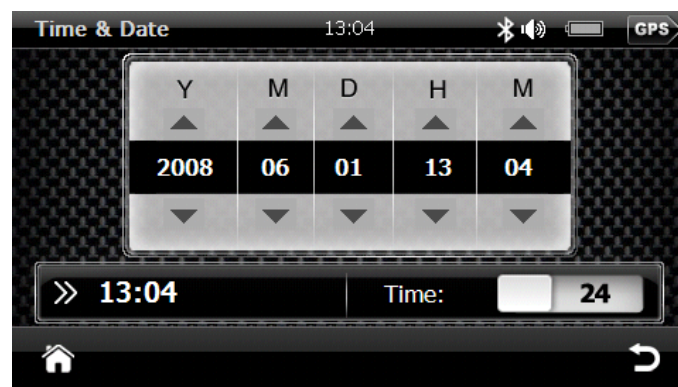



- 2) Date format: Y-M-D (Year-Month-Day), click ▲ or ▼ to select date.
- 3) Default time format is 24 hours, click H (hour) or M (minute) and ▲ or ▼ to set time.
- 4) Click to switch time format between 12 hours and 24 hours.
- 5) Click  to return to previous menu.

3.4.6 System information

In "Settings" menu, click "System".

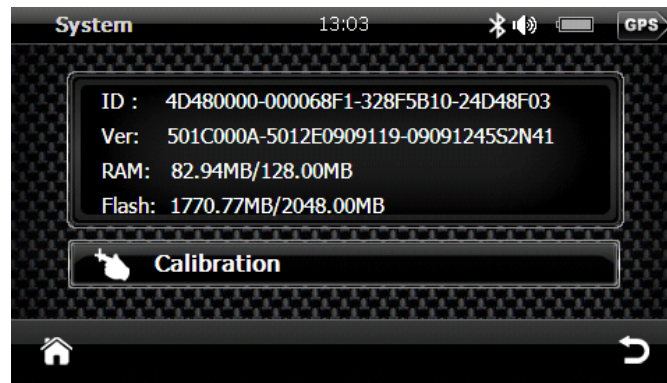

System information:

- ✓ ID: Device's hardware ID
- ✓ VER: Device's software version
- ✓ RAM: Random Access Memory, free RAM / total RAM
- ✓ FLASH: FLASH Memory, free FLASH / total FLASH

4. R-Mount Installation



1. Determine Mounting Location

Choose an ideal location in your vehicle that enables you and/or a passenger to access your device quickly and easily. Determine either a DASHBOARD or WINDSHIELD mounting location.

* Respect all local laws and observe the regulations on the use and mounting of portable electronic devices in your vehicle. Mounting of any device on windshields and dashboards may be prohibited by law in your area.

WARNING: *Never manually operate a portable electronic device while driving.*

WARNING: *Never mount device on or close to an airbag. This may create a deadly situation in the event of an airbag deployment.*

2. Clean Mounting Location

Use an alcohol pad to clean the selected dashboard or windshield mounting location. Let it dry completely before proceeding to stick it.

3. Remove Mount Base

Unscrew the mount from the adhesive dashboard base.

* If mounting to windshield, use suction cup base and skip to Step 6. Steps 4-5 for Dashboard Mounting only

4. Prep Adhesive Mounting Base

Carefully peel off the red protective backing from the adhesive mounting base.



5. Mount Adhesive Base to Dash

Position the adhesive base on the area of the dash you cleaned with the alcohol pad. Press down with even pressure for 30-60 seconds to fully secure base to the dash.

* Skip to Step 7. Step 6 for Windshield Mounting only

6. Secure Suction Cup Base to Windshield

Install the included suction cup to the mount by pushing the threaded part through the mount so the threads are on the top side of the mount base (hint: press the suction cup threads firmly through the hole on the mount to make sure you can get enough movement when tightening to create a good seal on the glass. If you have trouble attaching to the glass after tightening up the nut you may not have the windshield suction cup base seated far enough into the mount.)

Ensure nut is tightened down enough to form a tight seal between mount and windshield glass. Ensure device can be viewed safely/properly in chosen location.

7. Secure Mount to Base

Place mount onto base thread. Secure mount to base by tightening nut. Ensure device can be viewed safely/properly in chosen location.

8. Mount Device to Base Using Included Adapters

Included adapters are designed to fit a specific device only. Be sure to choose the correct adapter for your specific device/model.

WARNING: Improper or incorrect adapter use may damage the mount or the device.

Attach the appropriate included adapter onto the back of your device (see images below for reference). Slide the adapter into mount base slot and lock retainer tab as shown.

9. Mount Device Using Universal Adhesive Mount Tabs

To attach a device for which an adapter has not been included, use the supplied universal adhesive mount tabs. Attach the adhesive mount tab to an appropriate location on the back of your device. Slide the adapter into mount base adapter slot.

To Adjust/Tighten Mount Arm Joints

To further adjust mount arm pivot/tension, remove the nut from the mount base and use the integrated hex nut tool to loosen/tighten mount arm pivot joints. After adjusting to desired tension, re-tighten nut down to re-secure mount/ device to base.



5. Sync GPS Device with PC

5.1 Application and functions

This software is developed for mobile device with WIN CE platform to connect and synchronize data with PC.

Copyright: This software is under copyright of Microsoft Corporation.

5.2 Operating Environment

Hardware platform: PIII hardware and above

Software platform: Microsoft Windows 98/ME/2000/2003/XP

Requirements: This software is compiled by Windows Install. Installation of this software would require support of MSI service in your PC.

5.3 Active sync software installation

- 1) Please make sure your system support MSI format installation. Double click "ActiveSync4.5CN.msi" and enter installation interface. Tick to agree the terms and conditions and click "Next".

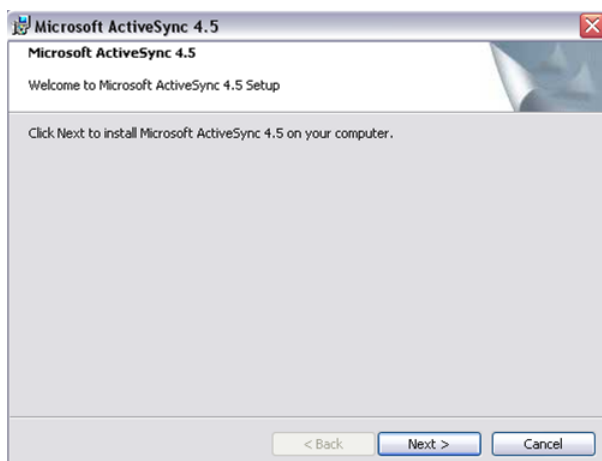



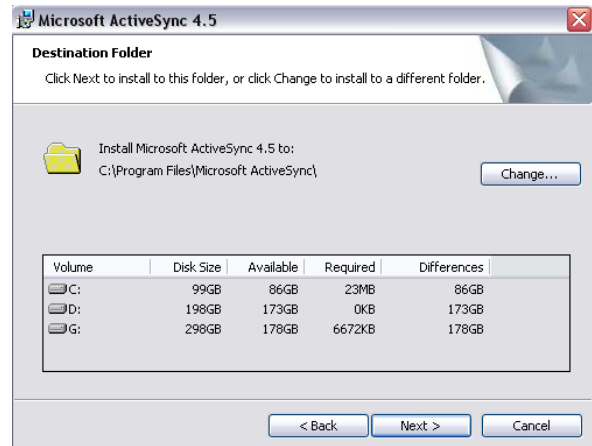
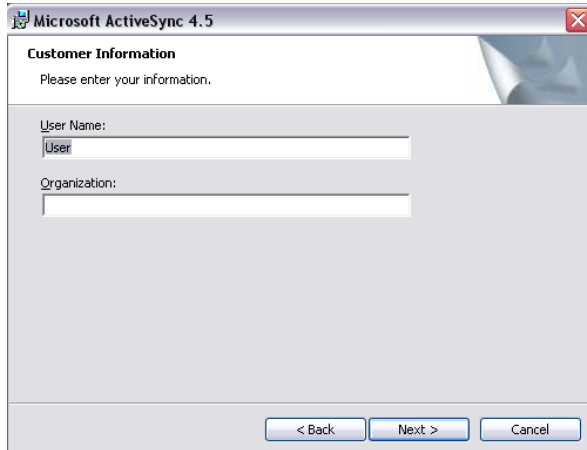

2) Input your personal information as required and click "Next".

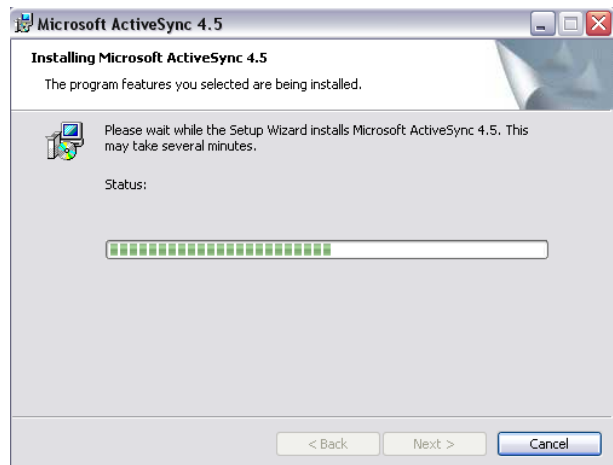
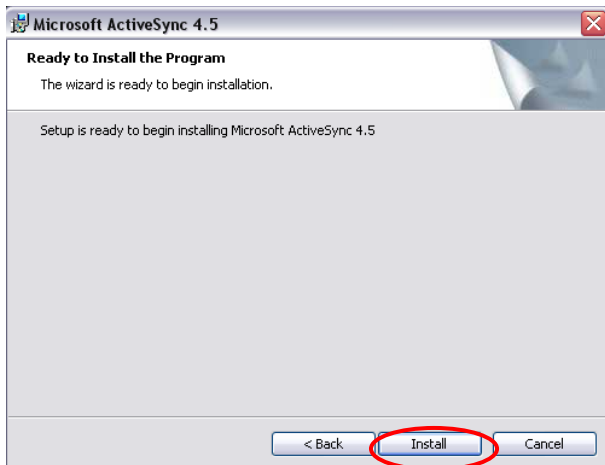

3) Choose directory and click "Next" to proceed to click "Install".





- 4) Restart PC after installation process complete. Icon of this software  will appear on task bar column.

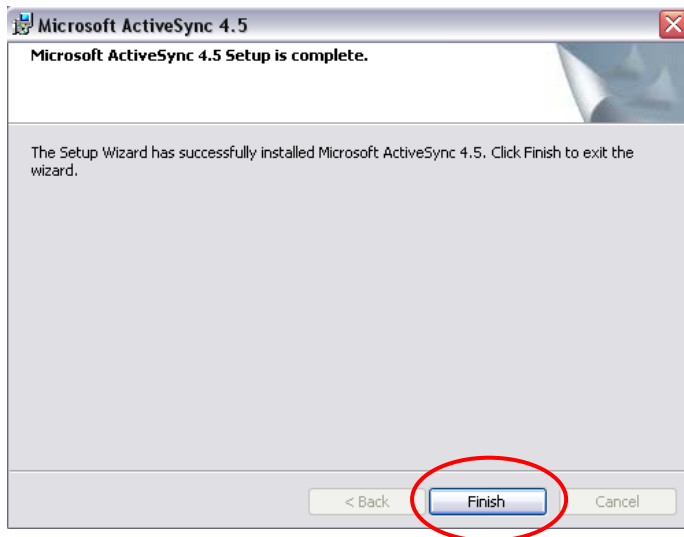

- 5) After installation of this software, an icon of Mobile Device will show in "My Computer". When GPS device is connected, user may click on this icon to access folders of the device.

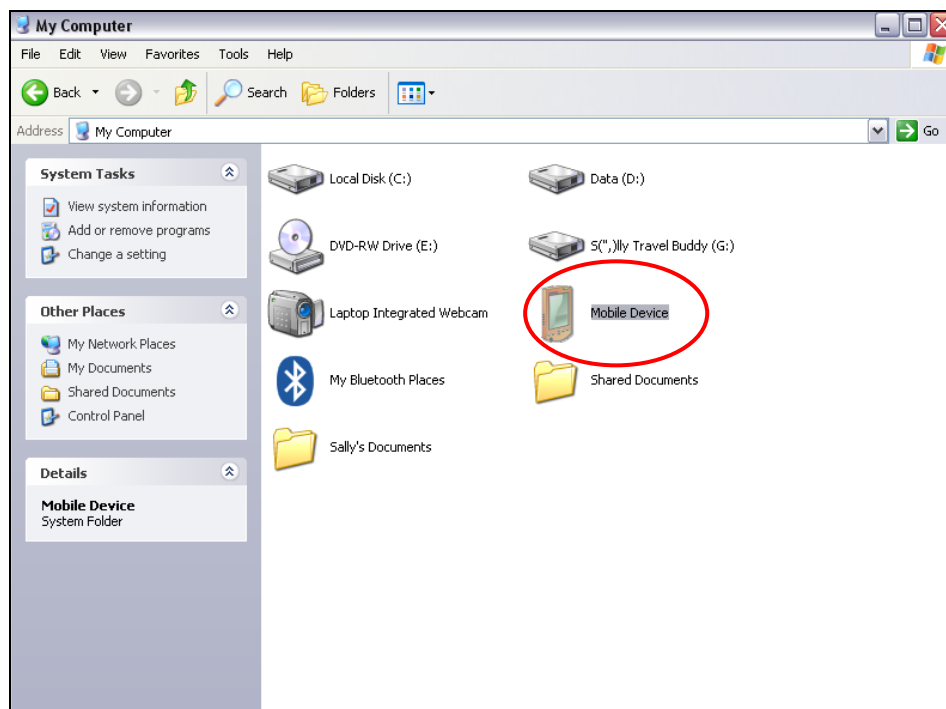



5.4 Using Active Sync software

- 1) Switch on GPS device and connect to PC. Icon  will rotate and shine.

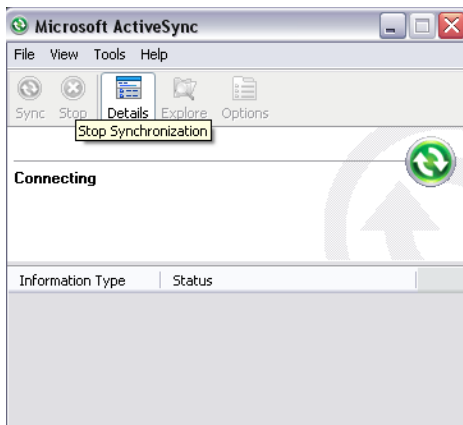

- 2) Tick in "Establish Connection" and click "Next" to proceed to settings, choose Default Settings and click "Next", then click "Complete".

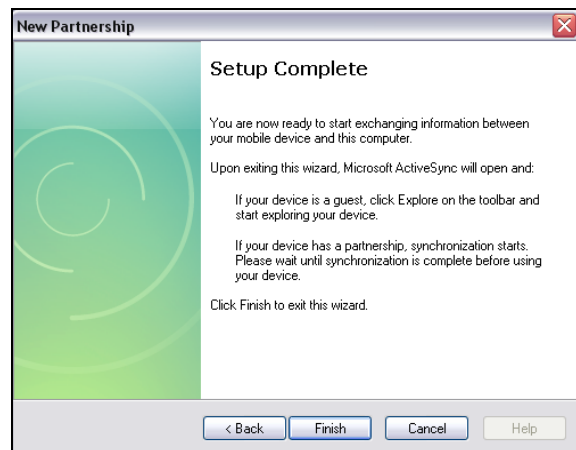
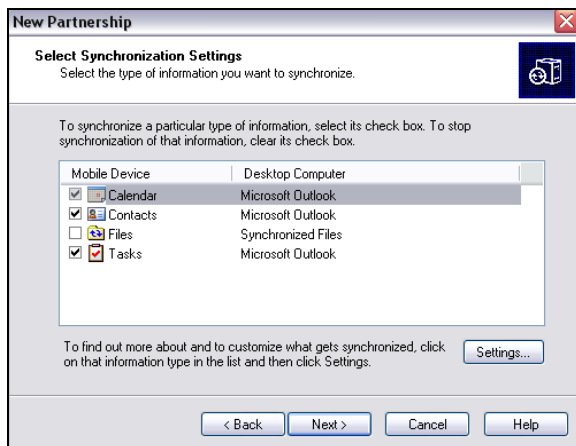



3) Clicking "Complete" will start connection of GPS device and PC.

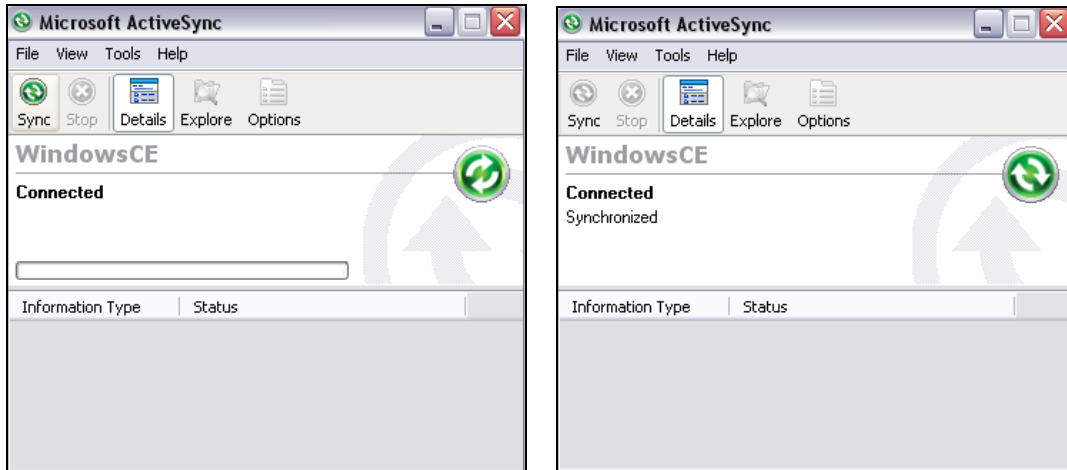

4) Click "Browse" to see GPS device information and access to folders in the device. User may copy, cut, paste and delete files.

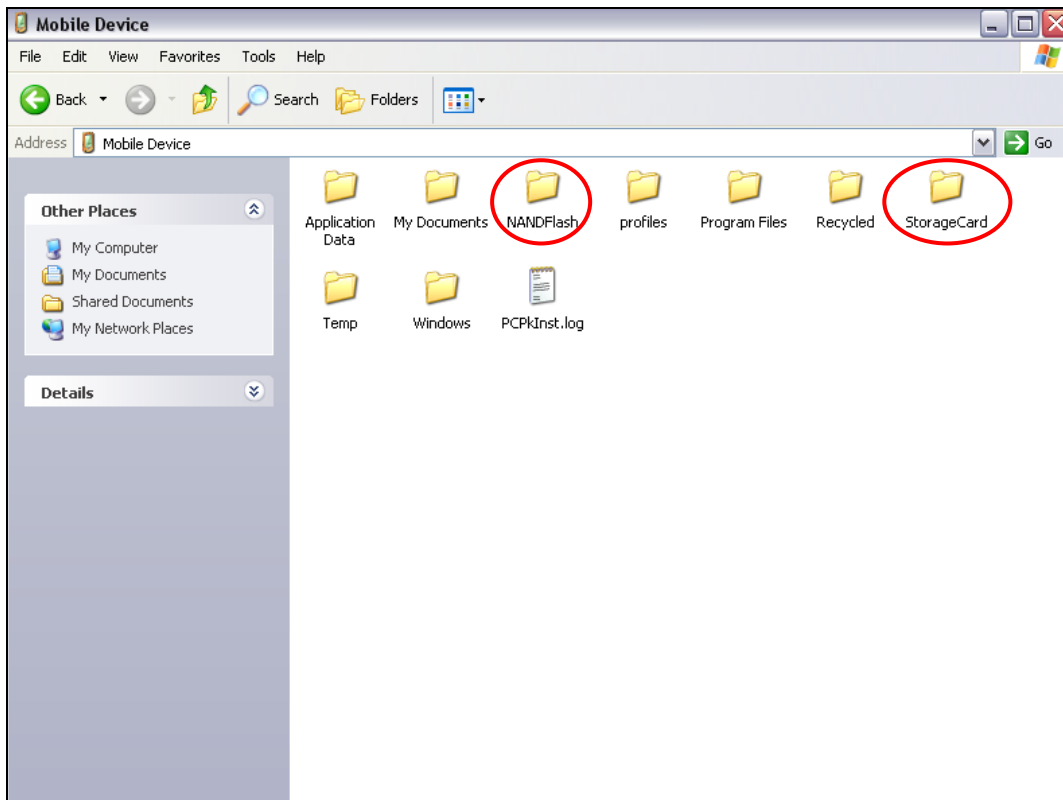



6. FAQ

[Attention] If your problem still persists as after using this FAQ, please contact your nearest customer service centre or distributor.

1. Device unable to start-up.

- ✓ In the event when battery power is extreme low will cause the device unable to start-up. Please charge the battery and attempt to start-up again.

2. GPS problems

In the event of device unable to acquire satellite signal or bad reception, please make sure that the device is below clear sky without obstacles.

Please take note that GPS signal is affected by the following factors :

- ✓ Bad weather condition
- ✓ Existence of obstacles, e.g. building, tunnel, overhead bridge, trees, windscreen coating and etc.
- ✓ Interference by other in-car wireless device

3. Navigation software or map was deleted accidentally.

- ✓ Please contact your nearest customer service centre, dealer or distributor.

4. Standby time of the device too short.

- ✓ The battery standby time varies according to the external temperature. If external temperature is too low or too high, may shorten the duration. We suggest using the device under normal temperature.
- ✓ It also varies according to the method of use, screen of the device has higher power consumption, high sound volume and frequent operating the device will also shorten the standby time.