

BR-6258nL

Quick Installation Guide

07-2012 / v1.0

COPYRIGHT

Copyright © Edimax Technology Co., Ltd. all rights reserved. No part of this publication may be reproduced, transmitted, transcribed, stored in a retrieval system, or translated into any language or computer language, in any form or by any means, electronic, mechanical, magnetic, optical, chemical, manual or otherwise, without the prior written permission from Edimax Technology Co., Ltd.

Edimax Technology Co., Ltd. makes no representations or warranties, either expressed or implied, with respect to the contents hereof and specifically disclaims any warranties, merchantability, or fitness for any particular purpose. Any software described in this manual is sold or licensed as is. Should the programs prove defective following their purchase, the buyer (and not this company, its distributor, or its dealer) assumes the entire cost of all necessary servicing, repair, and any incidental or consequential damages resulting from any defect in the software. Edimax Technology Co., Ltd. reserves the right to revise this publication and to make changes from time to time in the contents hereof without the obligation to notify any person of such revision or changes.

The product you have purchased and the setup screen may appear slightly different from those shown in this QIG. For more information about this product, please refer to the user manual on the CD-ROM. The software and specifications are subject to change without notice. Please visit our website www.edimax.com for updates. All brand and product names mentioned in this manual are trademarks and/or registered trademarks of their respective holders.

Notice According to GNU General Public License Version 2

This product includes software that is subject to the GNU General Public License version 2. The program is free software and distributed without any warranty of the author. We offer, valid for at least three years, to give you, for a charge no more than the costs of physically performing source distribution, a complete machine-readable copy of the corresponding source code.

Edimax Technology Co., Ltd.

Add: No. 3, Wu-Chuan 3rd Rd., Wu-Ku Industrial Park, New Taipei City, Taiwan (R.O.C.)

Tel: +886-2-77396888

Email: sales@edimax.com.tw

INTRODUCTION SUR LE PRODUIT

Merci d'avoir acheté le routeur de voyage et point d'accès sans fil personnel Edimax BR-6258nL ! Ce routeur miniature est un choix idéal pour les grands voyageurs. Son installation simple permet à tout utilisateur d'ordinateur de configurer un environnement réseau en quelques minutes et de partager une connexion à Internet.

I. Contenu de l'emballage

Avant d'utiliser ce routeur, veuillez vérifier que rien ne manque dans l'emballage et contacter votre revendeur pour lui réclamer les éléments manquants le cas échéant :

- Routeur de voyage (x 1)
- Guide d'installation rapide (x 1)
- CD avec GIR multilingue et manuel utilisateur (x 1)

II. Aspect du produit

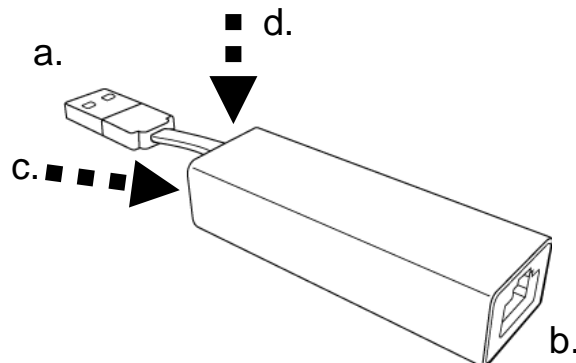

a. Connecteur et câble USB. Ce connecteur peut être branché dans le port USB d'un ordinateur ou dans un adaptateur secteur USB, comme ceux qui sont fournis avec les téléphones mobiles.



Remarque: Le connecteur USB de cet appareil transmet uniquement du courant électrique, il ne transmet **pas** de données. Cet appareil peut être configuré uniquement grâce à une connexion sans fil.



Remarque: Pour éviter d'endommager l'appareil, veuillez tenir le connecteur lors du branchement et du débranchement du connecteur USB. Ne tirez pas sur le corps du routeur de voyage.



b. Port Ethernet. Ce port est utilisé pour se brancher à une connexion Internet filaire.



Remarque: Veuillez ne pas raccorder ce port Ethernet au port Ethernet de votre ordinateur : cela ne fonctionnera *pas*. Ce port doit être raccordé à un point d'accès ou un modem xDSL/câble.

c. Touche WPS/Réinitialisation. Appuyez sur ce bouton pendant 2 secondes pour activer le mode WPS ou pendant 10 secondes pour réinitialiser l'appareil.

d. Voyant DEL. Deux voyants se trouvent sous le boîtier de l'appareil, une bleue et une verte.

III. État du voyant

Voyant	Couleur	État du voyant	Descriptif
Alimentation	Bleu	Clignotant	Rapide : L'appareil est en cours d'initialisation Lent : L'appareil est en cours de réinitialisation
		Allumé fixe	L'appareil est alimenté normalement
		Éteint	L'appareil n'est pas alimenté
WPS	Vert	Allumé fixe	Lorsqu'une connexion WPS a été établie, le voyant sera allumé pendant 5 minutes
		Clignotant	WPS en cours
		Éteint	Aucune alimentation ou pas de WPS en cours



Remarque: Lorsque le voyant WPS clignote, cela signifie que le WPS est en cours. Veuillez ne pas appuyer sur le bouton WPS avant que le voyant ne cesse de clignoter, sous peine de provoquer une erreur.

IV. Installation rapide



Remarque: Avant d'utiliser ce routeur de voyage, veuillez vous assurer que votre ordinateur est configuré comme client DHCP (obtention automatique d'une adresse IP à partir d'un serveur DHCP). Si vous n'êtes pas sûr, veuillez consulter le manuel de l'utilisateur.

1. Retirez l'emballage en plastique transparent de l'appareil.
2. Insérez le connecteur USB du routeur de voyage dans un port USB de votre ordinateur ou dans un adaptateur secteur USB.

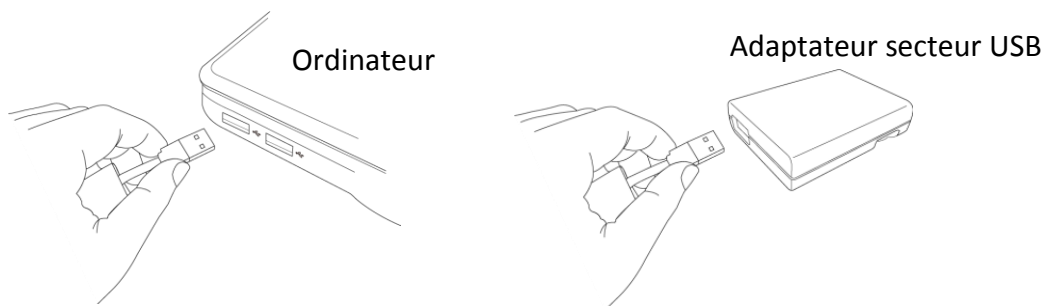

Le **voyant d'alimentation bleu** s'allume pendant 10 à 15 secondes. Le voyant commence ensuite à clignoter rapidement pendant 10 à 15 secondes pendant l'initialisation de l'appareil. Lorsque le **voyant bleu** ne clignote plus, l'appareil a terminé son initialisation.

3. Recherchez un réseau ayant un ID similaire à **Edimax5fb728** (comme sur la figure ci-dessous) dans les connexions sans fil à proximité. Les six derniers caractères seront différents pour chaque routeur de voyage et seront basés sur l'adresse MAS de votre routeur.



Vous pouvez aussi trouver l'ID sur la carte de clé d'accès fournie ou sur une étiquette se trouvant sur le routeur de voyage.

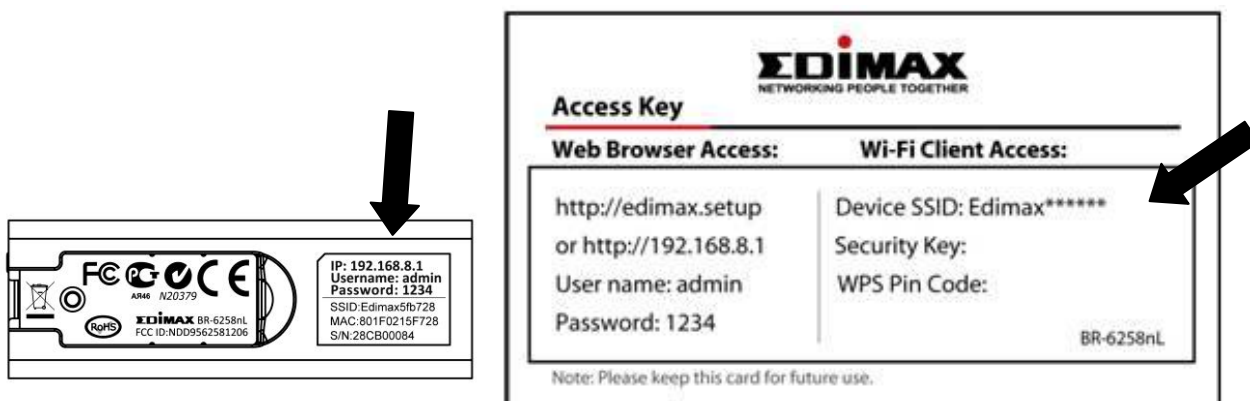

Connecter à ce réseau sans fil.

4. Ouvrez le navigateur Internet Explorer(enter <http://edimax.setup>) . Il vous est demandé de saisir un nom d'utilisateur et un mot de passe. Le nom d'utilisateur par défaut est **admin**et le mot de passe par défaut est **1234**.

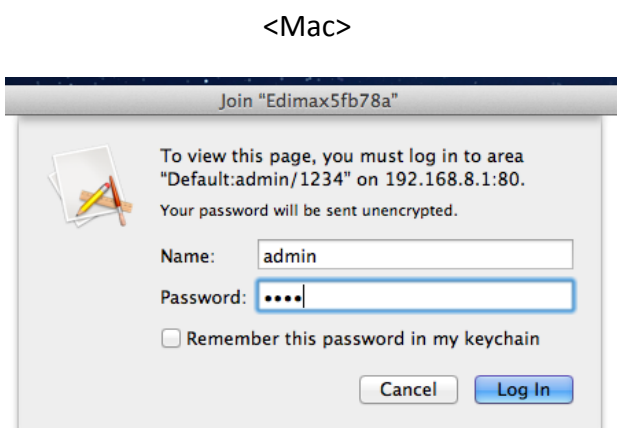

5. La première page de configuration s'affiche. La première étape du processus de configuration est de nommer le routeur et de fournir une clé de sécurité. Le nom de l'appareil par défaut est son ID, tandis que la clé de sécurité doit comprendre entre 8 et 32 caractères. Lorsque ces deux paramètres sont configurés, cliquez sur SUIVANT pour continuer.

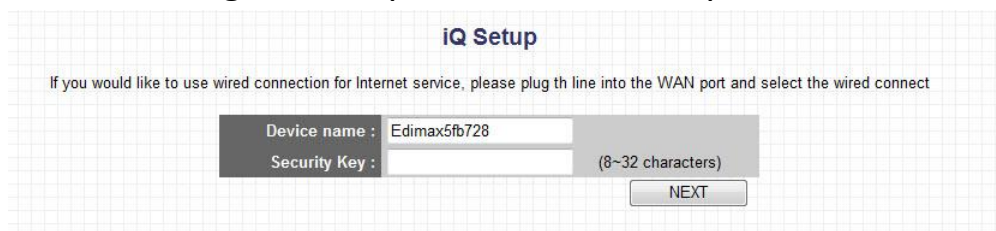

6. Le routeur de voyage sauvegarde les paramètres et redémarre. L'appareil se déconnecte automatiquement de votre ordinateur pendant le redémarrage.

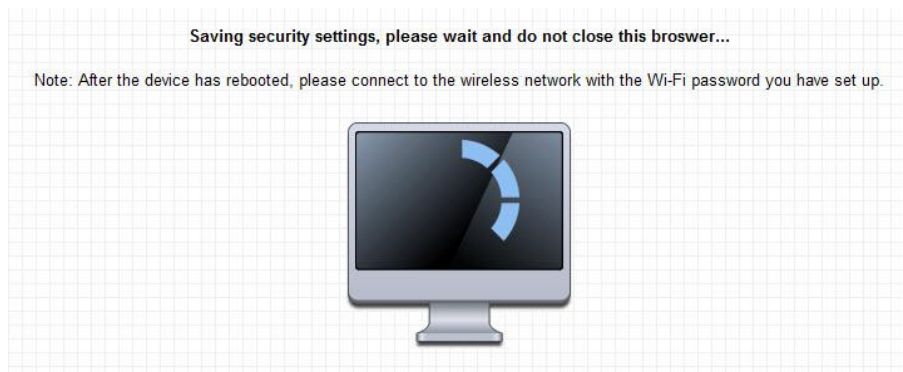

7. Lorsque l'écran suivant s'affiche, l'appareil a terminé son redémarrage. Reconnectez-vous au routeur de voyage en recherchant parmi les réseaux sans fil disponibles le nom de l'appareil et la clé de sécurité que vous avez configurés à l'étape 5 (vos paramètres sont affichés sur l'écran de l'ordinateur comme indiqué par la flèche).

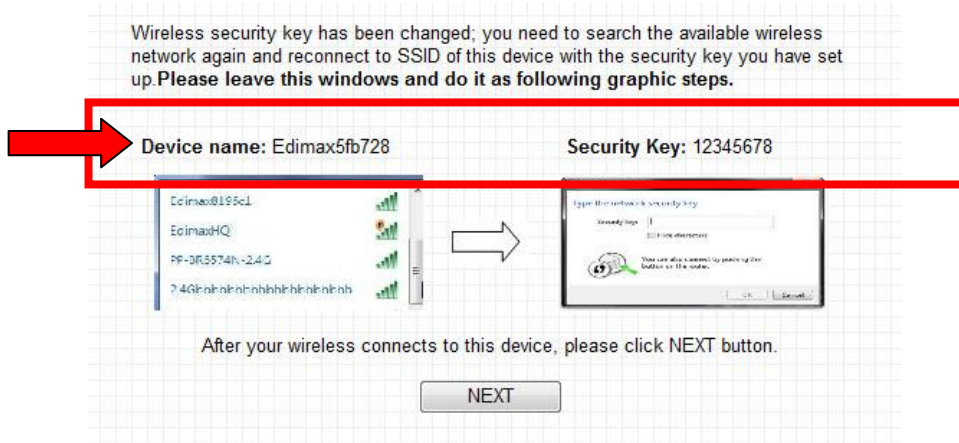

Lorsque votre ordinateur s'est reconnecté à l'appareil, cliquez sur SUIVANT.

8. Il vous sera demandé de choisir parmi les modes filaire et WISP.

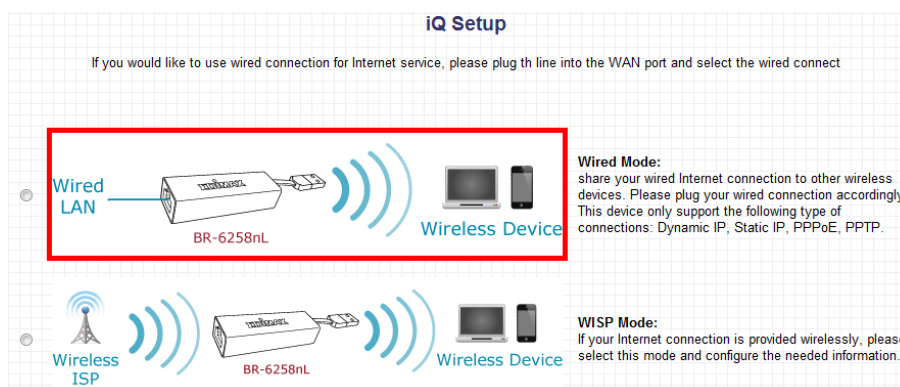

IV.a. Mode de connexion filaire

Le mode de connexion filaire permet au routeur de voyage de recevoir une connexion Internet filaire par le biais de son port Ethernet et de diffuser cette connexion sans fil.

1. Insérez le câble réseau connecté à Internet dans le port Ethernet du routeur de voyage, puis sélectionnez l'option du mode filaire sur l'écran de configuration.

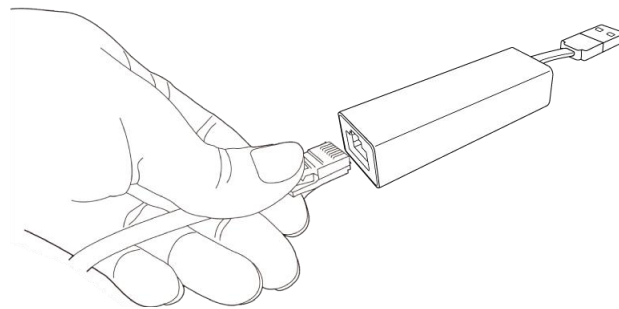

2. Le routeur de voyage détectera votre type de réseau étendu et testera la connexion à Internet.



3. Si la connexion au réseau étendu utilise une IP dynamique et que la connexion a réussi, un écran final de félicitations s'affiche. Si vous devez saisir les informations de votre FAI, le nom d'utilisateur, le mot de passe ou les informations de DNS, veuillez suivre les indications à l'écran. Après avoir réussi la connexion, vous pouvez choisir de commencer à utiliser immédiatement Internet ou d'effectuer une configuration plus avancée. Sur cet écran, vous pouvez configurer un marque-page vers le site <http://edimax.go>, qui vous conduira directement à l'écran de configuration web du routeur de voyage.

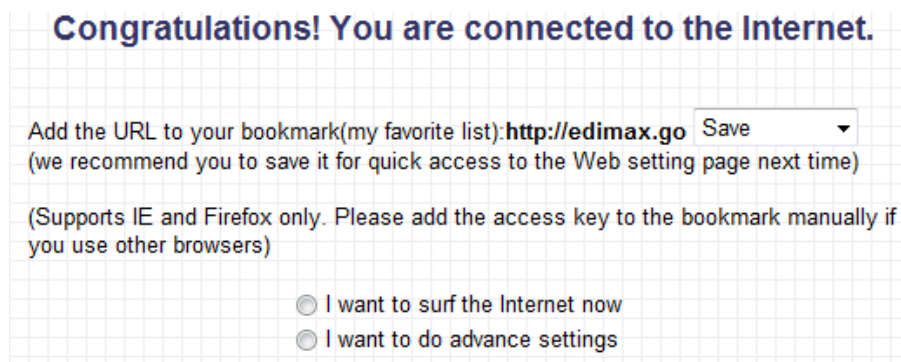

IV.b. Mode WISP

En mode WISP, le routeur de voyage reçoit un signal sans fil et le diffuse à plusieurs appareils sans fil.

1. Sélectionnez le mode WISP sur l'écran de configuration.

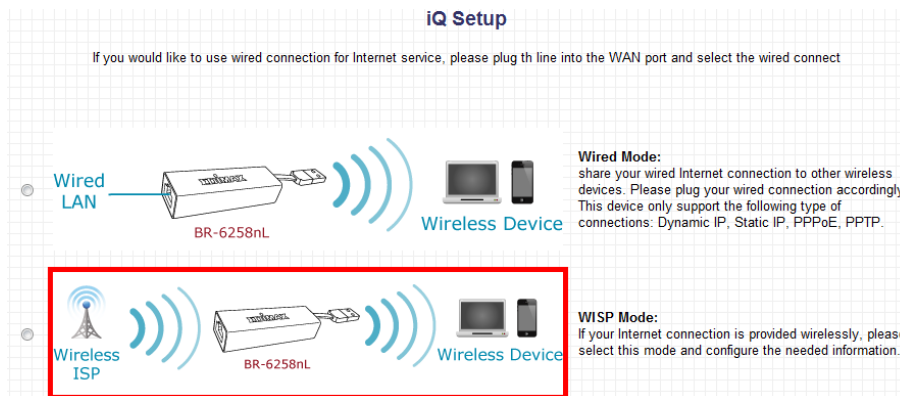

2. Le routeur de voyage détecte automatiquement les réseaux Wi-Fi disponibles. Sélectionnez le réseau auquel vous voulez vous connecter. Si le réseau exige une clé de sécurité, saisissez-la ici.

Si le réseau auquel vous voulez vous connecter ne s'affiche pas, veuillez essayer de cliquer sur le bouton Actualiser ou de déplacer le routeur de voyage plus près du point d'accès sans fil racine.

Si le réseau sans fil auquel vous voulez vous connecter ne diffuse pas son SSID (c'est-à-dire s'il a été choisi de masquer son ID), vous pouvez vous y connecter manuellement si vous connaissez son SSID.

WISP

In this mode, all ethernet ports are bridged together and the wireless client will connect to ISP access point. The NAT is enabled and PCs in ethernet ports share the same IP to ISP through wireless LAN. You must set the wireless to client mode first and connect to the ISP AP in Site-Survey page. The connection type can be setup in WAN page by using PPPoE, DHCP client, PPTP client or static IP.

Select	SSID	Band	Channel	Encryption	Signal
<input type="radio"/>	Edimax	(B+G+N)	11	WPA2-PSK	76
<input type="radio"/>	EdimaxHQ	(B+G+N)	9	no	64
<input type="radio"/>	602-NAS-ROUTER	(B+G)	11	WPA-PSK	58
<input type="radio"/>	ROSWIN	(B+G+N)	11	WPA2-PSK	56
<input type="radio"/>	default	(B+G+N)	1	no	56
<input type="radio"/>	IP6FW	(B+G)	7	WPA-PSK	54
<input type="radio"/>	AirportExpress_Jimmy	(B+G+N)	1	WPA2-PSK	48
<input type="radio"/>	6228NC	(B+G+N)	11	WPA2-PSK	46
<input type="radio"/>	EdimaxHQ	(B+G+N)	11	no	40
<input type="radio"/>	bellin.807	(B+G+N)	11	WPA-PSK/WPA2-PSK	40
<input type="radio"/>	4iPAD	(B+G+N)	11	WPA-PSK	36
<input type="radio"/>	EdimaxHQ	(B+G+N)	9	no	34
<input type="radio"/>	Hunter	(B+G+N)	4	WPA-PSK/WPA2-PSK	28
<input type="radio"/>	PnV_LongRun_6F	(B+G+N)	9	no	22
<input type="radio"/>	MEETING_ROOM_6F	(B+G+N)	1	no	22

Hidden SSID

Setup manually

*Sélectionnez un appareil
*Saisissez sa clé de sécurité.

Appuyez sur le bouton SUIVANT pour continuer.

3. Le routeur de voyage sauvegarde les paramètres modifiés et peut redémarrer. Si c'est le cas, reconnectez-vous au routeur de voyage en recherchant parmi les réseaux sans fil disponibles le nom de l'appareil que vous avez configuré à l'étape 5 de la section **Installation rapide**. Saisissez la clé de sécurité de 8 à 32 caractères que vous avez configurée.

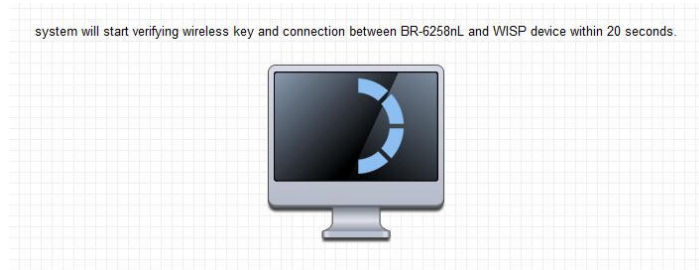

4. Après la reconnexion, le routeur de voyage vérifiera la connexion. Si la connexion réussit, l'écran de configuration vous indiquera l'ID du réseau sans fil auquel il est connecté, ainsi que la clé de sécurité. Il vous sera ensuite demandé de permettre au routeur de configurer les paramètres Internet automatiquement ou bien vous pouvez choisir de configurer les paramètres Internet manuellement. La sélection de « Configuration automatique d'Internet » fonctionne dans la plupart des cas. Si le routeur ne parvient pas à configurer automatiquement Internet, il vous demandera de le configurer manuellement. Pour plus de détails sur la configuration manuelle de la connexion, veuillez consulter le manuel de l'utilisateur.



5. Après la configuration des paramètres Internet, un écran final de félicitations s'affiche. Sur cet écran, vous pouvez configurer un marque-page vers le site <http://edimax.go>, qui vous conduira directement à l'écran de configuration web du routeur de voyage.

Vous pouvez maintenant commencer à naviguer immédiatement sur Internet ou vous pouvez choisir d'effectuer une configuration plus avancée.

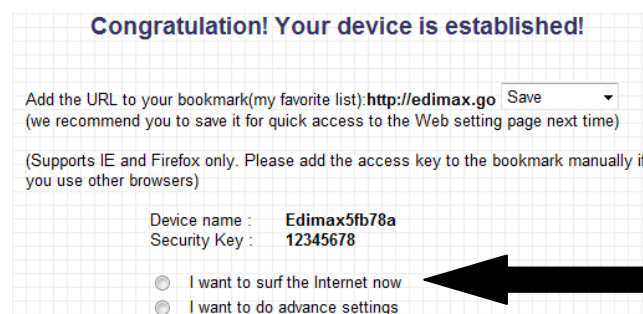

Vous verrez également la confirmation finale du nom et de la clé de sécurité du routeur de voyage. Souvenez-vous de ce nom et de la clé pour vos autres périphériques clients sans fil qui devront s'y connecter par la suite.

V. Connexion au routeur de voyage

Lorsqu'il est connecté à Internet, par connexion filaire ou par mode WISP, les autres périphériques sans fil peuvent se connecter à ce routeur de voyage et accéder à Internet par son intermédiaire.

1. Rechercher parmi les réseaux Wi-Fi à proximité l'ID du routeur de voyage et connectez-vous au routeur.

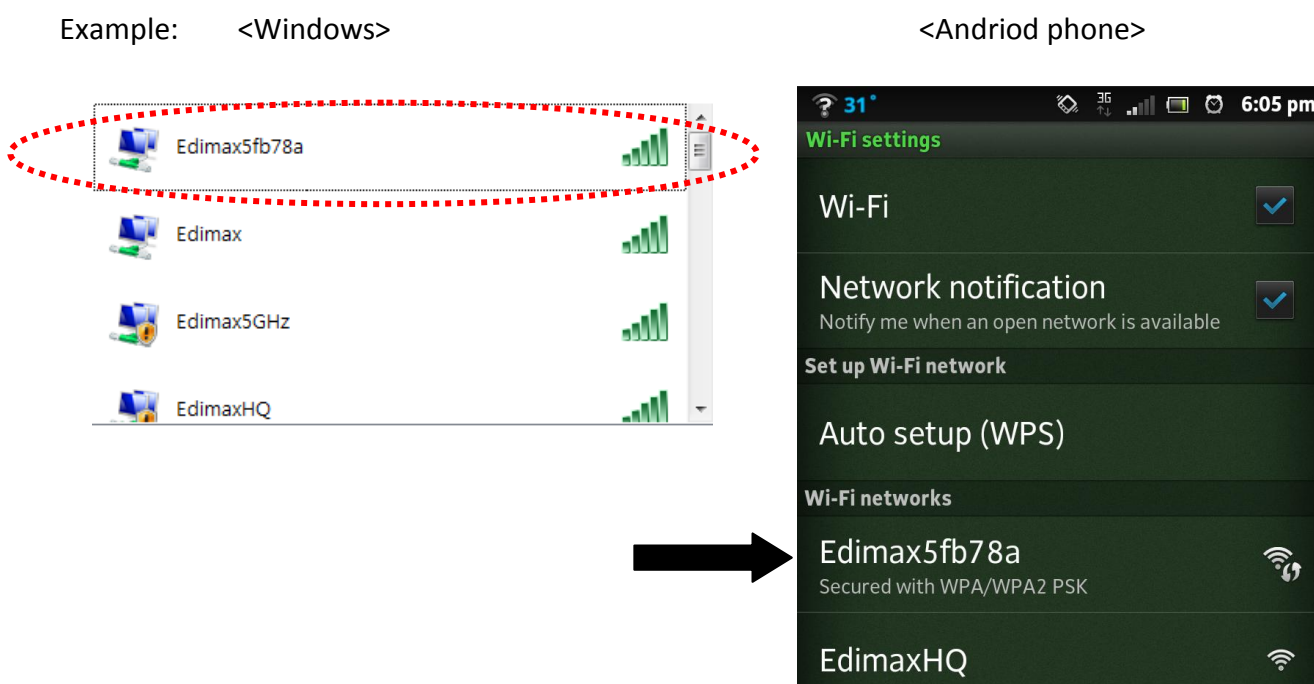

2. Saisissez la clé de sécurité sans fil que vous avez configurée auparavant.
3. Répétez l'opération pour tous les périphériques sans fil que vous souhaitez connecter à Internet. Le routeur de voyage diffusera le signal Internet sans fil et deviendra ainsi un point d'accès personnel pour vos périphériques sans fil.



VI. Réinitialisation du routeur de voyage

Si le routeur de voyage ne fonctionne pas comme prévu ou si vous souhaitez le réinitialiser et éliminer tous les paramètres, vous pouvez essayer de réinitialiser le routeur de voyage aux paramètres d'usine par défaut.

1. Assurez-vous que l'appareil est alimenté (en branchant le connecteur USB à un ordinateur ou à un adaptateur secteur USB).
2. Tenez le corps de l'appareil dans vos mains et maintenez enfoncé le **bouton WPS/réinitialisation** avec l'extrémité d'un trombone ou du capuchon d'un stylo pendant 10 secondes environ, jusqu'à ce que le **voyant bleu** commence à clignoter. Lorsque le voyant commence à clignoter, vous pouvez relâcher le bouton et l'appareil commencera la réinitialisation des paramètres d'usine par défaut.

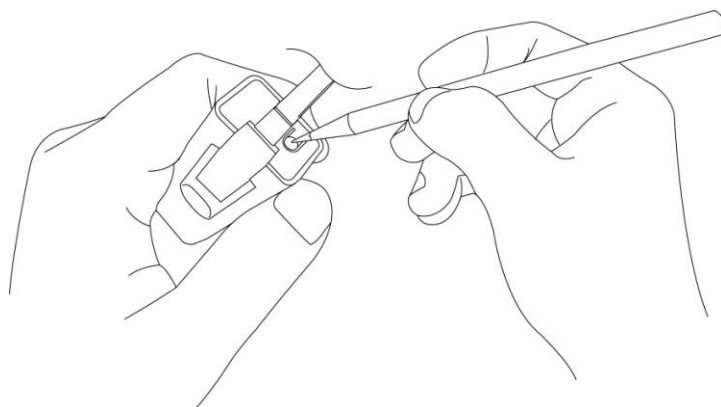

3. Le voyant restera d'abord allumé fixe pendant 10 à 15 secondes. Le voyant commencera ensuite à clignoter rapidement pendant 10 à 15 secondes pendant la réinitialisation de l'appareil. Lorsque le voyant reste allumé sans clignoter, l'appareil a terminé l'opération et il est prêt pour une nouvelle configuration.

Federal Communication Commission Interference Statement

This equipment has been tested and found to comply with the limits for a Class B digital device, pursuant to Part 15 of the FCC Rules. These limits are designed to provide reasonable protection against harmful interference in a residential installation. This equipment generates, uses and can radiate radio frequency energy and, if not installed and used in accordance with the instructions, may cause harmful interference to radio communications. However, there is no guarantee that interference will not occur in a particular installation. If this equipment does cause harmful interference to radio or television reception, which can be determined by turning the equipment off and on, the user is encouraged to try to correct the interference by one or more of the following measures:

- Reorient or relocate the receiving antenna.
- Increase the separation between the equipment and receiver.
- Connect the equipment into an outlet on a circuit different from that to which the receiver is connected.
- Consult the dealer or an experienced radio/TV technician for help.

FCC Caution

This device complies with Part 15 of the FCC Rules. Operation is subject to the following two conditions: (1) This device may not cause harmful interference, and (2) this device must accept any interference received, including interference that may cause undesired operation. Any changes or modifications not expressly approved by the party responsible for compliance could void the user's authority to operate this equipment.

Federal Communications Commission (FCC) Radiation Exposure Statement

This EUT is compliance with SAR for general population/uncontrolled exposure limits in ANSI/IEEE C95.1-1999 and had been tested in accordance with the measurement methods and procedures specified in OET Bulletin 65 Supplement C. This equipment should be installed and operated with minimum distance 0.5cm between the radiator & your body.

R&TTE Compliance Statement

This equipment complies with all the requirements of DIRECTIVE 1999/5/EC OF THE EUROPEAN PARLIAMENT AND THE COUNCIL of March 9, 1999 on radio equipment and telecommunication terminal equipment and the mutual recognition of their conformity (R&TTE). The R&TTE Directive repeals and replaces in the directive 98/13/EEC (Telecommunications Terminal Equipment and Satellite Earth Station Equipment) As of April 8, 2000.

Safety

This equipment is designed with the utmost care for the safety of those who install and use it. However, special attention must be paid to the dangers of electric shock and static electricity when working with electrical equipment. All guidelines of this and of the computer manufacture must therefore be allowed at all times to ensure the safe use of the equipment.

EU Countries Intended for Use

The ETSI version of this device is intended for home and office use in Austria, Belgium, Bulgaria, Cyprus, Czech, Denmark, Estonia, Finland, France, Germany, Greece, Hungary, Ireland, Italy, Latvia, Lithuania, Luxembourg, Malta, Netherlands, Poland, Portugal, Romania, Slovakia, Slovenia, Spain, Sweden, Turkey, and United Kingdom. The ETSI version of this device is also authorized for use in EFTA member states: Iceland, Liechtenstein, Norway, and Switzerland.

EU Countries Not Intended for Use

None

EU Declaration of Conformity

- English:** This equipment is in compliance with the essential requirements and other relevant provisions of Directive 1999/5/EC, 2009/125/EC.
- Français:** Cet équipement est conforme aux exigences essentielles et autres dispositions de la directive 1999/5/CE, 2009/125/CE.
- Čeština:** Toto zařízení je v souladu se základními požadavky a ostatními příslušnými ustanoveními směrnic 1999/5/ES, 2009/125/ES.
- Polski:** Urządzenie jest zgodne z ogólnymi wymaganiami oraz szczególnymi warunkami określonymi Dyrektywą UE 1999/5/WE, 2009/125/WE.
- Română:** Acest echipament este în conformitate cu cerințele esențiale și alte prevederi relevante ale Directivei 1999/5/CE, 2009/125/CE.
- Русский:** Это оборудование соответствует основным требованиям и положениям Директивы 1999/5/EC, 2009/125/EC.
- Magyar:** Ez a berendezés megfelel az alapvető követelményeknek és más vonatkozó irányelveknek (1999/5/EK, 2009/125/EK)
- Türkçe:** Bu cihaz 1999/5/EC, 2009/125/EC direktifleri zorunlu istekler ve diğer hükümlerle ile uyumludur.
- Українська:** Обладнання відповідає вимогам і умовам директиви 1999/5/EC, 2009/125/EC.
- Slovenčina:** Toto zariadenie spĺňa základné požiadavky a ďalšie príslušné ustanovenia smerníc 1999/5/ES, 2009/125/ES.
- Deutsch:** Dieses Gerät erfüllt die Voraussetzungen gemäß den Richtlinien 1999/5/EC, 2009/125/EC.
- Español:** El presente equipo cumple los requisitos esenciales de la Directiva 1999/5/CE, 2009/125/CE.
- Italiano:** Questo apparecchio è conforme ai requisiti essenziali e alle altre disposizioni applicabili della Direttiva 1999/5/CE, 2009/125/CE.
- Nederlands:** Dit apparaat voldoet aan de essentiële eisen en andere van toepassing zijnde bepalingen van richtlijn 1999/5/EG, 2009/125/EG.
- Português:** Este equipamento cumpre os requisitos essenciais da Directiva 1999/5/CE, 2009/125/CE.
- Norsk:** Dette utstyret er i samsvar med de viktigste kravene og andre relevante regler i Direktiv 1999/5/EF, 2009/125/EF.
- Svenska:** Denna utrustning är i överensstämmelse med de väsentliga kraven och övriga relevanta bestämmelser i direktiv 1999/5/EG, 2009/125/EG.
- Dansk:** Dette udstyr er i overensstemmelse med de væsentligste krav og andre relevante forordninger i direktiv 1999/5/EF, 2009/125/EF.
- suomen kieli:** Tämä laite täyttää direktiivien 1999/5/EY, 2009/125/EY oleelliset vaatimukset ja muut asiaankuuluvat määräykset.

FOR USE IN 



WEEE Directive & Product Disposal



At the end of its serviceable life, this product should not be treated as household or general waste. It should be handed over to the applicable collection point for the recycling of electrical and electronic equipment, or returned to the supplier for disposal.

Declaration of Conformity

We, Edimax Technology Co., LTD., declare under our sole responsibility, that the equipment described below complies with the requirements of the European R&TTE directive (1999/5/EC, 2009/125/EC, 2006/95/EC).

Equipment: Wireless Personal Hotspot and Travel Router

Model No.: BR-6258nL

Report No.: ER241221, EA241221, EH24122, L241221

The following European standards for essential requirements have been followed:

Spectrum: ETSI EN 300 328 V1.7.1 (2006-10);

EN 301 489-1 V1.9.2 (2011-09)

EN 301 489-17 V2.1.1 (2009-05);

EMF: EN 50385:2002

Safety (LVD): IEC 60950-1:2005 (2nd Edition); Am 1:2009

EN-60950-1:2006+A11:2009+A1:2010+A12:2011

Edimax Technology Co., Ltd.
No. 3, Wu Chuan 3rd Road,
Wu-Ku Industrial Park,
New Taipei City, Taiwan



Date of Signature: July 30th, 2012

Signature:

A handwritten signature in black ink, appearing to read 'Albert Chang'.

Printed Name: Albert Chang

Title: Director

Edimax Technology CO., LTD.

Notice According to GNU General Public License Version 2

This product includes software that is subject to the GNU General Public License version 2. The program is free software and distributed without any warranty of the author. We offer, valid for at least three years, to give you, for a charge no more than the costs of physically performing source distribution, a complete machine-readable copy of the corresponding source code.

Das Produkt beinhaltet Software, die den Bedingungen der GNU/GPL-Version 2 unterliegt. Das Programm ist eine sog. „Free Software“, der Autor stellt das Programm ohne irgendeine Gewährleistungen zur Verfügung. Wir bieten Ihnen für einen Zeitraum von drei Jahren an, eine vollständige maschinenlesbare Kopie des Quelltextes der Programme zur Verfügung zu stellen – zu nicht höheren Kosten als denen, die durch den physikalischen Kopiervorgang anfallen.

GNU GENERAL PUBLIC LICENSE Version 2, June 1991

Copyright (C) 1989, 1991 Free Software Foundation, Inc. 51 Franklin Street, Fifth Floor, Boston, MA 02110-1301, USA
Everyone is permitted to copy and distribute verbatim copies of this license document, but changing it is not allowed.

Preamble

The licenses for most software are designed to take away your freedom to share and change it. By contrast, the GNU General Public License is intended to guarantee your freedom to share and change free software--to make sure the software is free for all its users. This General Public License applies to most of the Free Software Foundation's software and to any other program whose authors commit to using it. (Some other Free Software Foundation software is covered by the GNU Lesser General Public License instead.) You can apply it to your programs, too.

When we speak of free software, we are referring to freedom, not price. Our General Public Licenses are designed to make sure that you have the freedom to distribute copies of free software (and charge for this service if you wish), that you receive source code or can get it if you want it, that you can change the software or use pieces of it in new free programs; and that you know you can do these things.

To protect your rights, we need to make restrictions that forbid anyone to deny you these rights or to ask you to surrender the rights. These restrictions translate to certain responsibilities for you if you distribute copies of the software, or if you modify it.

For example, if you distribute copies of such a program, whether gratis or for a fee, you must give the recipients all the rights that you have. You must make sure that they, too, receive or can get the source code. And you must show them these terms so they know their rights.

We protect your rights with two steps: (1) copyright the software, and (2) offer you this license which gives you legal permission to copy, distribute and/or modify the software.

Also, for each author's protection and ours, we want to make certain that everyone understands that there is no warranty for this free software. If the software is modified by someone else and passed on, we want its recipients to know that what they have is not the original, so that any problems introduced by others will not reflect on the original authors' reputations.

Finally, any free program is threatened constantly by software patents. We wish to avoid the danger that redistributors of a free program will individually obtain patent licenses, in effect making the program proprietary. To prevent this, we have made it clear that any patent must be licensed for everyone's free use or not licensed at all.

The precise terms and conditions for copying, distribution and modification follow.

TERMS AND CONDITIONS FOR COPYING, DISTRIBUTION AND MODIFICATION

0. This License applies to any program or other work which contains a notice placed by the copyright holder saying it may be distributed under the terms of this General Public License. The "Program", below, refers to any such program or work, and a "work based on the Program" means either the Program or any derivative work under copyright law: that is to say, a work containing the Program or a portion of it, either verbatim or with modifications and/or translated into another language. (Hereinafter, translation is included without limitation in the term "modification".) Each licensee is addressed as "you".

Activities other than copying, distribution and modification are not covered by this License; they are outside its scope. The act of running the Program is not restricted, and the output from the Program is covered only if its contents constitute a work based on the Program (independent of having been made by running the Program). Whether that is true depends on what the Program does.

1. You may copy and distribute verbatim copies of the Program's source code as you receive it, in any medium, provided that you conspicuously and appropriately publish on each copy an appropriate copyright notice and disclaimer of warranty; keep

intact all the notices that refer to this License and to the absence of any warranty; and give any other recipients of the Program a copy of this License along with the Program.

You may charge a fee for the physical act of transferring a copy, and you may at your option offer warranty protection in exchange for a fee.

2. You may modify your copy or copies of the Program or any portion of it, thus forming a work based on the Program, and copy and distribute such modifications or work under the terms of Section 1 above, provided that you also meet all of these conditions:

- a) You must cause the modified files to carry prominent notices stating that you changed the files and the date of any change.
- b) You must cause any work that you distribute or publish, that in whole or in part contains or is derived from the Program or any part thereof, to be licensed as a whole at no charge to all third parties under the terms of this License.
- c) If the modified program normally reads commands interactively when run, you must cause it, when started running for such interactive use in the most ordinary way, to print or display an announcement including an appropriate copyright notice and a notice that there is no warranty (or else, saying that you provide a warranty) and that users may redistribute the program under these conditions, and telling the user how to view a copy of this License. (Exception: if the Program itself is interactive but does not normally print such an announcement, your work based on the Program is not required to print an announcement.)

These requirements apply to the modified work as a whole. If identifiable sections of that work are not derived from the Program, and can be reasonably considered independent and separate works in themselves, then this License, and its terms, do not apply to those sections when you distribute them as separate works. But when you distribute the same sections as part of a whole which is a work based on the Program, the distribution of the whole must be on the terms of this License, whose permissions for other licensees extend to the entire whole, and thus to each and every part regardless of who wrote it.

Thus, it is not the intent of this section to claim rights or contest your rights to work written entirely by you; rather, the intent is to exercise the right to control the distribution of derivative or collective works based on the Program.

In addition, mere aggregation of another work not based on the Program with the Program (or with a work based on the Program) on a volume of a storage or distribution medium does not bring the other work under the scope of this License.

3. You may copy and distribute the Program (or a work based on it, under Section 2) in object code or executable form under the terms of Sections 1 and 2 above provided that you also do one of the following:

- a) Accompany it with the complete corresponding machine-readable source code, which must be distributed under the terms of Sections 1 and 2 above on a medium customarily used for software interchange; or,
- b) Accompany it with a written offer, valid for at least three years, to give any third party, for a charge no more than your cost of physically performing source distribution, a complete machine-readable copy of the corresponding source code, to be distributed under the terms of Sections 1 and 2 above on a medium customarily used for software interchange; or,
- c) Accompany it with the information you received as to the offer to distribute corresponding source code. (This alternative is allowed only for noncommercial distribution and only if you received the program in object code or executable form with such an offer, in accord with Subsection b above.)

The source code for a work means the preferred form of the work for making modifications to it. For an executable work, complete source code means all the source code for all modules it contains, plus any associated interface definition files, plus the scripts used to control compilation and installation of the executable. However, as a special exception, the source code distributed need not include anything that is normally distributed (in either source or binary form) with the major components (compiler, kernel, and so on) of the operating system on which the executable runs, unless that component itself accompanies the executable.

If distribution of executable or object code is made by offering access to copy from a designated place, then offering equivalent access to copy the source code from the same place counts as distribution of the source code, even though third parties are not compelled to copy the source along with the object code.

4. You may not copy, modify, sublicense, or distribute the Program except as expressly provided under this License. Any attempt otherwise to copy, modify, sublicense or distribute the Program is void, and will automatically terminate your rights under this License. However, parties who have received copies, or rights, from you under this License will not have their licenses terminated so long as such parties remain in full compliance.

5. You are not required to accept this License, since you have not signed it. However, nothing else grants you permission to modify or distribute the Program or its derivative works. These actions are prohibited by law if you do not accept this License. Therefore, by modifying or distributing the Program (or any work based on the Program), you indicate your acceptance of this License to do so, and all its terms and conditions for copying, distributing or modifying the Program or works based on it.

6. Each time you redistribute the Program (or any work based on the Program), the recipient automatically receives a license from the original licensor to copy, distribute or modify the Program subject to these terms and conditions. You may not impose any further restrictions on the recipients' exercise of the rights granted herein. You are not responsible for enforcing compliance by third parties to this License.

7. If, as a consequence of a court judgment or allegation of patent infringement or for any other reason (not limited to patent issues), conditions are imposed on you (whether by court order, agreement or otherwise) that contradict the conditions of this License, they do not excuse you from the conditions of this License. If you cannot distribute so as to satisfy simultaneously your obligations under this License and any other pertinent obligations, then as a consequence you may not distribute the Program at all. For example, if a patent license would not permit royalty-free redistribution of the Program by all those who receive copies directly or indirectly through you, then the only way you could satisfy both it and this License would be to refrain entirely from distribution of the Program.

If any portion of this section is held invalid or unenforceable under any particular circumstance, the balance of the section is intended to apply and the section as a whole is intended to apply in other circumstances.

It is not the purpose of this section to induce you to infringe any patents or other property right claims or to contest validity of any such claims; this section has the sole purpose of protecting the integrity of the free software distribution system, which is implemented by public license practices. Many people have made generous contributions to the wide range of software distributed through that system in reliance on consistent application of that system; it is up to the author/donor to decide if he or she is willing to distribute software through any other system and a licensee cannot impose that choice.

This section is intended to make thoroughly clear what is believed to be a consequence of the rest of this License.

8. If the distribution and/or use of the Program is restricted in certain countries either by patents or by copyrighted interfaces, the original copyright holder who places the Program under this License may add an explicit geographical distribution limitation excluding those countries, so that distribution is permitted only in or among countries not thus excluded. In such case, this License incorporates the limitation as if written in the body of this License.

9. The Free Software Foundation may publish revised and/or new versions of the General Public License from time to time. Such new versions will be similar in spirit to the present version, but may differ in detail to address new problems or concerns.

Each version is given a distinguishing version number. If the Program specifies a version number of this License which applies to it and "any later version", you have the option of following the terms and conditions either of that version or of any later version published by the Free Software Foundation. If the Program does not specify a version number of this License, you may choose any version ever published by the Free Software Foundation.

10. If you wish to incorporate parts of the Program into other free programs whose distribution conditions are different, write to the author to ask for permission. For software which is copyrighted by the Free Software Foundation, write to the Free Software Foundation; we sometimes make exceptions for this. Our decision will be guided by the two goals of preserving the free status of all derivatives of our free software and of promoting the sharing and reuse of software generally.

NO WARRANTY

11. BECAUSE THE PROGRAM IS LICENSED FREE OF CHARGE, THERE IS NO WARRANTY FOR THE PROGRAM, TO THE EXTENT PERMITTED BY APPLICABLE LAW. EXCEPT WHEN OTHERWISE STATED IN WRITING THE COPYRIGHT HOLDERS AND/OR OTHER PARTIES PROVIDE THE PROGRAM "AS IS" WITHOUT WARRANTY OF ANY KIND, EITHER EXPRESSED OR IMPLIED, INCLUDING, BUT NOT LIMITED TO, THE IMPLIED WARRANTIES OF MERCHANTABILITY AND FITNESS FOR A PARTICULAR PURPOSE. THE ENTIRE RISK AS TO THE QUALITY AND PERFORMANCE OF THE PROGRAM IS WITH YOU. SHOULD THE PROGRAM PROVE DEFECTIVE, YOU ASSUME THE COST OF ALL NECESSARY SERVICING, REPAIR OR CORRECTION.

12. IN NO EVENT UNLESS REQUIRED BY APPLICABLE LAW OR AGREED TO IN WRITING WILL ANY COPYRIGHT HOLDER, OR ANY OTHER PARTY WHO MAY MODIFY AND/OR REDISTRIBUTE THE PROGRAM AS PERMITTED ABOVE, BE LIABLE TO YOU FOR DAMAGES, INCLUDING ANY GENERAL, SPECIAL, INCIDENTAL OR CONSEQUENTIAL DAMAGES ARISING OUT OF THE USE OR INABILITY TO USE THE PROGRAM (INCLUDING BUT NOT LIMITED TO LOSS OF DATA OR DATA BEING RENDERED INACCURATE OR LOSSES SUSTAINED BY YOU OR THIRD PARTIES OR A FAILURE OF THE PROGRAM TO OPERATE WITH ANY OTHER PROGRAMS), EVEN IF SUCH HOLDER OR OTHER PARTY HAS BEEN ADVISED OF THE POSSIBILITY OF SUCH DAMAGES.



ΣDIMAX
NETWORKING PEOPLE TOGETHER

Edimax Technology Co., Ltd.
No.3, Wu-Chuan 3rd Road, Wu-Gu,
New Taipei City 24891, Taiwan

Edimax Technology Europe B.V.
Nijverheidsweg 25 5683 CJ Best
The Netherlands

Edimax Computer Company
3350 Scott Blvd., Bldg.15 Santa Clara,
CA 95054, USA

www.edimax.com