



---

## **F734-E Series Terminals**



**User's Manual**

---



Datalogic Mobile S.r.l.  
Via S. Vitalino 13  
40012 - Lippo di Calderara di Reno  
Bologna - Italy

F734-E Series Terminals

Ed.: 07/2010



© 2006-2010 Datalogic Mobile S.r.l. • All rights reserved. • Protected to the fullest extent under U.S. and international laws. • Copying, or altering of this document is prohibited without express written consent from Datalogic Mobile S.r.l.

Datalogic and the Datalogic logo are registered trademarks of Datalogic S.p.A. in many countries, including the U.S.A. and the E.U.

Formula is registered trademark of Datalogic Mobile S.r.l. in many countries, including the U.S.A. and the E.U.

All other brand and product names mentioned herein are for identification purposes only and may be trademarks or registered trademarks of their respective owners.

Datalogic reserves the right to make modifications and improvements without prior notification.

Datalogic shall not be liable for technical or editorial errors or omissions contained herein, nor for incidental or consequential damages resulting from the use of this material.

# CONTENTS

---

	<b>REFERENCES .....</b>	<b>v</b>
	Conventions.....	v
	Reference Documentation.....	v
	Services and Support .....	v
	<b>SAFETY REGULATIONS.....</b>	<b>vi</b>
	General Safety Rules.....	vi
	Laser Safety.....	vii
	Radio Compliance .....	xii
	FCC Compliance .....	xiii
	Patents.....	xiii
	WEEE Compliance .....	xiv
	<b>GENERAL VIEW .....</b>	<b>xvii</b>
<b>1</b>	<b>INTRODUCTION .....</b>	<b>1</b>
1.1	Terminal Description.....	1
1.1.1	F734-E.....	1
1.1.2	F734-E/RF .....	2
1.2	Application Development Programs .....	3
1.3	Downloading EasyGen™ Demo .....	4
1.4	Package Contents .....	5
1.5	Accessories .....	5
<b>2</b>	<b>CONNECTIONS .....</b>	<b>7</b>
2.1	Cradle .....	7
2.2	Connection to the Host Computer .....	8
2.2.1	RS232 Connection.....	8
2.2.2	Connection with Eavesdrop Interface .....	10
2.2.3	RS485 Connection.....	11
2.2.4	RF Connection.....	13
2.3	Connection Cable .....	14
<b>3</b>	<b>USE AND OPERATION .....</b>	<b>16</b>
3.1	Description of Keys Using EasyGen™ .....	16
3.2	Barcode Scanning .....	19
3.3	Deleting the Application Program .....	20
3.4	Downloading Data to Host.....	21
<b>4</b>	<b>MAINTENANCE .....</b>	<b>22</b>
4.1	Charging the Batteries .....	22
4.2	Replacing the Batteries .....	24
4.3	Cleaning the Terminal.....	26
<b>5</b>	<b>TROUBLESHOOTING .....</b>	<b>27</b>

<b>6</b>	<b>TECHNICAL FEATURES.....</b>	<b>28</b>
	<b>GLOSSARY.....</b>	<b>30</b>
	<b>INDEX.....</b>	<b>32</b>

# REFERENCES

---

## CONVENTIONS

This manual uses the following conventions:

“User” or “Operator” refers to anyone using a F734-E Terminal.

“Device” refers to the F734-E Terminal.

“You” refers to the System Administrator or Technical Support person using this manual to install, operate, maintain or troubleshoot a F734-E Terminal.

## REFERENCE DOCUMENTATION

For further details refer to the Manuals of the various programs provided on the CD-ROM.

## SERVICES AND SUPPORT

Datalogic Mobile provides several services as well as technical support through its website. Log on to **[www.mobile.datalogic.com](http://www.mobile.datalogic.com)** and click on the links indicated for further information including:

- **PRODUCTS**

Search through the links to arrive at your product page where you can download specific **Manuals** and **Software & Utilities** including:

- **EasyGen™ Demo Version**

EasyGen™ Demo software allows developers to easily and quickly build personalized applications of average complexity in a Windows environment.

- **EasySend™**

A Windows-based file uploading program.

- **SERVICES & SUPPORT**

- **Datalogic Services** - Warranty Extensions and Maintenance Agreements

- **Authorised Repair Centres**

- **CONTACT US**

E-mail form and listing of Datalogic Mobile Subsidiaries

# SAFETY REGULATIONS

---



## NOTE

*Read this manual carefully before performing any type of connection or repair on the terminal.*

*The user is responsible for any damages caused by incorrect use of the equipment or by inobservance of the indication supplied in this manual.*

## GENERAL SAFETY RULES

Use only the components supplied by the manufacturer for the specific F734-E series terminal being used. The use of cradles other than those supplied with the terminal or indicated in the list in the appendix could cause serious damage to the terminal.

Do not attempt to disassemble the F734-E series terminal, as it does not contain parts that can be repaired by the user. Any tampering will invalidate the warranty.

When replacing the batteries or at the end of the operative life of the terminal, disposal must be performed in compliance with the laws in force.

Do not submerge the terminal in liquid products.

# LASER SAFETY

The laser light is visible to the human eye and is emitted from the window indicated in the figure.

## F734-E

Laser beam output window



Figure 1 - F734-E Laser Safety Labels

## F734-E/RF

Laser beam output window



Figure 2 - F734-E/RF Laser Safety Labels

I	D	F	E
LA LUCE LASER È VISIBILE ALL'OCCHIO UMANO E VIENE EMESSA DALLA FINESTRA INDICATA NELLA FIGURA.	DIE LASER-STRABLUNG IST FÜR DAS MENSCHLICHE AUGE SICHTBAR UND WIRD AM STRAHLAUS-TRITTSFENSTER AUSGESENDET (SIEHE BILD)	LE RAYON LASER EST VISIBLE À L'OEIL NU ET IL EST ÉMIS PAR LA FENÊTRE DÉSIGNÉE SUR L'ILLUSTRATION DANS LA FIGURE	A LUZ LÁSER ES VISIBLE AL OJO HUMANO Y ES EMITIDA POR LA VENTANA INDICADA EN LA FIGURA.

I	D	F	E
LUCE LASER NON FISSARE IL FASCIO APPARECCHIO LASER DI CLASSE 2 MASSIMA POTENZA D'USCITA: LUNGHEZZA D'ONDA EMESSA: CONFORME A EN 60825-1(2001)	LASERSTRABLUNG NICHT IN DEN STRAHL BLICKEN PRODUKT DER LASERKLASSE 2 MAXIMALE AUSGANGSLEISTUNG: WELLENLÄGE: ENTSR. EN 60825-1(2001)	RAYON LASER EVITER DE REGARDER LE RAYON APPAREIL LASER DE CLASSE 2 PUISSANCE DE SORTIE: LONGUER D'ONDE EMISE: CONFORME A EN 60825-1 (2001)	RAYO LÁSER NO MIRAR FIJO EL RAYO APARATO LÁSER DE CLASE 2 MÁXIMA POTENCIA DE SALIDA: LONGITUD DE ONDA EMITIDA: CONFORME A EN 60825-1 (2001)



## ENGLISH

The following information is provided to comply with the rules imposed by international authorities and refers to the correct use of your terminal.

### STANDARD LASER SAFETY REGULATIONS

This product conforms to the applicable requirements of both CDRH 21 CFR 1040 and EN 60825-1 at the date of manufacture.

For installation, use and maintenance, it is not necessary to open the device.

	<i>Use of controls or adjustments or performance of procedures other than those specified herein may result in exposure to hazardous visible laser light.</i>
<b>CAUTION</b>	

The product utilizes a low-power laser diode. Although staring directly at the laser beam momentarily causes no known biological damage, avoid staring at the beam as one would with any very strong light source, such as the sun. Avoid that the laser beam hits the eye of an observer, even through reflective surfaces such as mirrors, etc.

## ITALIANO

Le seguenti informazioni vengono fornite dietro direttive delle autorità internazionali e si riferiscono all'uso corretto del terminale.

### NORMATIVE STANDARD PER LA SICUREZZA LASER

Questo prodotto risulta conforme alle normative vigenti sulla sicurezza laser alla data di produzione: CDRH 21 CFR 1040 e EN 60825-1.

Non si rende mai necessario aprire l'apparato per motivi di installazione, utilizzo o manutenzione.

	<i>L'utilizzo di procedure o regolazioni differenti da quelle descritte nella documentazione può provocare un'esposizione pericolosa a luce laser visibile.</i>
<b>ATTENZIONE</b>	

Il prodotto utilizza un diodo laser a bassa potenza. Sebbene non siano noti danni riportati dall'occhio umano in seguito ad una esposizione di breve durata, evitare di fissare il raggio laser così

come si eviterebbe qualsiasi altra sorgente di luminosità intensa, ad esempio il sole. Evitare inoltre di dirigere il raggio laser negli occhi di un osservatore, anche attraverso superfici riflettenti come gli specchi.

## DEUTSCH

Die folgenden Informationen stimmen mit den Sicherheitshinweisen überein, die von internationalen Behörden auferlegt wurden, und sie beziehen sich auf den korrekten Gebrauch vom Terminal.

### NORM FÜR DIE LASERSICHERHEIT

Dies Produkt entspricht am Tag der Herstellung den gültigen EN 60825-1 und CDRH 21 CFR 1040 Normen für die Lasersicherheit. Es ist nicht notwendig, das Gerät wegen Betrieb oder Installations-, und Wartungsarbeiten zu öffnen.

	<i>Jegliche Änderungen am Gerät sowie Vorgehensweisen, die nicht in dieser Betriebsanleitung beschreiben werden, können ein gefährliches Laserlicht verursachen.</i>
<b>ACHTUNG</b>	

Das Produkt benutzt eine Laserdiode. Obwohl zur Zeit keine Augenschäden von kurzen Einstrahlungen bekannt sind, sollten Sie es vermeiden für längere Zeit in den Laserstrahl zu schauen, genauso wenig wie in starke Lichtquellen (z.B. die Sonne). Vermeiden Sie es, den Laserstrahl weder gegen die Augen eines Beobachters, noch gegen reflektierende Oberflächen zu richten.

## FRANÇAIS

Les informations suivantes sont fournies selon les règles fixées par les autorités internationales et se réfèrent à une correcte utilisation du terminal.

### NORMES DE SECURITE LASER

Ce produit est conforme aux normes de sécurité laser en vigueur à sa date de fabrication: CDRH 21 CFR 1040 et EN 60825-1.

Il n'est pas nécessaire d'ouvrir l'appareil pour l'installation, l'utilisation ou l'entretien.



**ATTENTION**

*L'utilisation de procédures ou réglages différents de ceux donnés ici peut entraîner une dangereuse exposition à lumière laser visible.*

Le produit utilise une diode laser. Aucun dommage aux yeux humains n'a été constaté à la suite d'une exposition au rayon laser. Eviter de regarder fixement le rayon, comme toute autre source lumineuse intense telle que le soleil. Eviter aussi de diriger le rayon vers les yeux d'un observateur, même à travers des surfaces réfléchissantes (miroirs, par exemple).

## **ESPAÑOL**

Las informaciones siguientes son presentadas en conformidad con las disposiciones de las autoridades internacionales y se refieren al uso correcto del terminal.

### **NORMATIVAS ESTÁNDAR PARA LA SEGURIDAD LÁSER**

Este aparato resulta conforme a las normativas vigentes de seguridad láser a la fecha de producción: CDRH 21 CFR 1040 y EN 60825-1.

No es necesario abrir el aparato para la instalación, la utilización o la manutención.



**ATENCIÓN**

*La utilización de procedimientos o regulaciones diferentes de aquellas descritas en la documentación puede causar una exposición peligrosa a la luz láser visible.*

El aparato utiliza un diodo láser a baja potencia. No son notorios daños a los ojos humanos a consecuencia de una exposición de corta duración. Eviten de mirar fijo el rayo láser así como evitarían cualquiera otra fuente de luminosidad intensa, por ejemplo el sol. Además, eviten de dirigir el rayo láser hacia los ojos de un observador, también a través de superficies reflectantes como los espejos.

# RADIO COMPLIANCE

## Information for the User

### ENGLISH

Contact the competent authority responsible for the management of radio frequency devices of your country to verify the eventual necessity of a user license. Refer to the web site <http://europa.eu.int/comm/enterprise/rtte/spectr.htm> for further information.

### ITALIANO

Prendi contatto con l'autorità competente per la gestione degli apparati a radio frequenza del tuo paese, per verificarne l'eventuale necessità della licenza d'uso. Inoltre puoi trovare ulteriori informazioni al sito:

<http://europa.eu.int/comm/enterprise/rtte/spectr.htm>.

### FRANÇAIS

Contactez l'autorité compétente en la gestion des appareils à radio fréquence de votre pays pour vérifier la nécessité du permis d'usage. Pour tout renseignement vous pouvez vous adresser au site web:

<http://europa.eu.int/comm/enterprise/rtte/spectr.htm>.

### DEUTSCH

Um die Notwendigkeit der Verwendungslizenz zu prüfen, wenden Sie sich an die Behörde, die auf der Radiofrequenzgerätsführung Ihres Lands bewandert ist. Weitere Informationen sind verfügbar auf dem Web Site:

<http://europa.eu.int/comm/enterprise/rtte/spectr.htm>.

### ESPAÑOL

Contacta con la autoridad competente para la gestión de los dispositivos de radio frecuencia de tu país, para verificar si es necesario la licencia de uso. Además se puede encontrar mas información en el sitio web:

<http://europa.eu.int/comm/enterprise/rtte/spectr.htm>.



## **FCC COMPLIANCE**

This compliance refers only to the F734-E batch model.

Modifications or changes to this equipment without the expressed written approval of Datalogic Mobile could void the authority to use this equipment.

This device complies with PART 15 of the FCC Rules. Operation is subject to the following two conditions: (1) This device may not cause harmful interference, and (2) this device must accept any interference which may cause undesired operation.

This equipment has been tested and found to comply with the limits for a Class A digital device, pursuant to part 15 of the FCC Rules. These limits are designed to provide reasonable protection against harmful interference when the equipment is operated in a commercial environment. This equipment generates, uses, and can radiate radio frequency energy and, if not installed and used in accordance with the instruction manual, may cause harmful interference to radio communications. Operation of this equipment in a residential area is likely to cause harmful interference in which case the user will be required to correct the interference at his own expense.

## **PATENTS**

This product is covered by one or more of the following patents.

US Pat.: 5,992,740.

European Pat.: 789,315 B1.

## WEEE COMPLIANCE



### **Informazione degli utenti ai sensi della Direttiva Europea 2002/96/EC**

L'apparecchiatura che riporta il simbolo del bidone barrato deve essere smaltita, alla fine della sua vita utile, separatamente dai rifiuti urbani.

Smaltire l'apparecchiatura in conformità alla presente Direttiva consente di:

- evitare possibili conseguenze negative per l'ambiente e per la salute umana che potrebbero invece essere causati dall'errato smaltimento dello stesso;
- recuperare materiali di cui è composto al fine di ottenere un importante risparmio di energia e di risorse.

Per maggiori dettagli sulle modalità di smaltimento, contattare il Fornitore dal quale è stata acquistata l'apparecchiatura o consultare la sezione dedicata sul sito [www.mobile.datalogic.com](http://www.mobile.datalogic.com).

### **Information for the user in accordance with the European Commission Directive 2002/96/EC**

At the end of its useful life, the product marked with the crossed out wheeled wastebin must be disposed of separately from urban waste.

Disposing of the product according to this Directive:

- avoids potentially negative consequences to the environment and human health which otherwise could be caused by incorrect disposal
- enables the recovery of materials to obtain a significant savings of energy and resources.

For more detailed information about disposal, contact the supplier that provided you with the product in question or consult the dedicated section at the website [www.mobile.datalogic.com](http://www.mobile.datalogic.com).

## **Information aux utilisateurs concernant la Directive Européenne 2002/96/EC**

Au terme de sa vie utile, le produit qui porte le symbole d'un caisson à ordures barré ne doit pas être éliminé avec les déchets urbains.

Éliminer ce produit selon cette Directive permet de:

- éviter les retombées négatives pour l'environnement et la santé dérivant d'une élimination incorrecte
- récupérer les matériaux dans le but d'une économie importante en termes d'énergie et de ressources

Pour obtenir des informations complémentaires concernant l'élimination, veuillez contacter le fournisseur auprès duquel vous avez acheté le produit ou consulter la section consacrée au site Web [www.mobile.datalogic.com](http://www.mobile.datalogic.com).

## **Información para el usuario de acuerdo con la Directiva Europea 2002/96/CE**

Al final de su vida útil, el producto marcado con un símbolo de contenedor de basura móvil tachado no debe eliminarse junto a los desechos urbanos.

Eliminar este producto de acuerdo con la Directiva permite de:

- evitar posibles consecuencias negativas para el medio ambiente y la salud derivadas de una eliminación inadecuada
- recuperar los materiales obteniendo así un ahorro importante de energía y recursos

Para obtener una información más detallada sobre la eliminación, por favor, póngase en contacto con el proveedor donde lo compró o consultar la sección dedicada en el Web site [www.mobile.datalogic.com](http://www.mobile.datalogic.com).

## **Benutzerinformation bezüglich Richtlinie 2002/96/EC der europäischen Kommission**

Am Ende des Gerätelebenszyklus darf das Produkt nicht über den städtischen Hausmüll entsorgt werden. Eine entsprechende Mülltrennung ist erforderlich.

Beseitigung des Produkts entsprechend der Richtlinie:

- verhindert negative Auswirkungen für die Umwelt und die Gesundheit der Menschen
- ermöglicht die Wiederverwendung der Materialien und spart somit Energie und Ressourcen

Weitere Informationen zu dieser Richtlinie erhalten sie von ihrem Lieferanten über den sie das Produkt erworben haben, oder besuchen sie unsere Homepage unter [www.mobile.datalogic.com](http://www.mobile.datalogic.com).



# GENERAL VIEW

---



Figure 3 - F734-E Series Terminals Overview

Key:

- A) Laser beam output window
- B) Multi-function LED
- C) Reset key (protected)
- D) Cradle communications window
- E) Battery charger contacts
- F) Antenna



# 1 INTRODUCTION

---

## 1.1 TERMINAL DESCRIPTION

Two different models of this terminal are provided:

**Formula 734-E:** communicates with the host computer via a cradle connection;

**Formula 734-E/RF:** communicates with the host computer via radio frequency or normal cradle connection.

### 1.1.1 F734-E

The F734-E terminal is a lightweight, pocket-sized and fully programmable terminal, claiming the greatest sales success of the Datalogic PDC range.

With up to 1MB of RAM memory for managing large databases and 512KB of Flash memory for application programs of large dimensions, F734-E solves the most complex application needs. Furthermore, the "overspeed" capability boosts software performance, thus increasing the operator's productivity.

Its excellent reading performance allows barcodes to be scanned up to a distance of 70 cm, while the long life batteries assure a large autonomy able to cover more than one work shift. The wide backlit LCD display, with 4 lines and 16 characters, clearly shows much information while the practical 25-key alphanumeric keyboard allows data, codes and descriptions to be input very quickly. Protection against bumps, dust and water are all features that make F734-E suitable for intensive use even in industrial environments.

By using the optional EasyGen™ Application Generator or the DS for Formula™ software packages for Windows environment, developers can easily customize applications according to the end user specific needs.

The most common data collection applications such as inventory, picking and shipping/receiving, especially in the Retail market, are easy to perform thanks to the F734-E features. Nevertheless, the F734-E, thanks to the best price/performance ratio of its category, is considered the ideal solution of many applications even in Transportation & Logistics and Manufacturing markets.

### 1.1.2 F734-E/RF

The F734-E/RF terminal is a lightweight, pocket-sized and fully programmable radio frequency terminal.

It solves the most complex application needs and exploits the "overspeed" feature to boost software performance, has 512 KB of RAM memory for managing large databases and 512 KB of Flash memory for application programs of large dimensions.

Software developers can easily customize applications according to the specific needs of the end user by using the DS for Formula™ software package and integrating F734-E/RF within the new Datalogic STAR-System™, the RF narrow band solution for mobile applications. Barcode reading capabilities are the best you can desire due to the high performance and high visibility laser engine, while the long life batteries assure large autonomy, able to cover more than one work shift.



Figure 4 - F734-E series terminals overview

Key:

- A) Laser beam output window
- B) Multi-function LED
- C) Reset key (protected)
- D) Cradle communications window
- G) Battery charger contacts
- H) Antenna

The F734-E series terminals have a backlit LCD graphic display of 16 characters by 4 lines plus a line in the upper part of the display for the programmable icons:

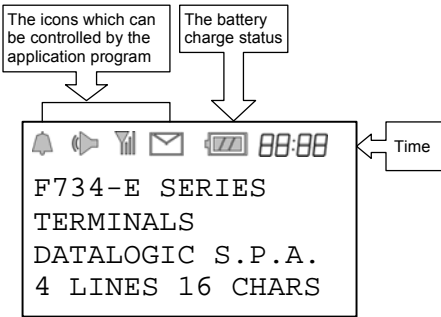

Figure 5 - Terminal Display

## 1.2 APPLICATION DEVELOPMENT PROGRAMS

By using the optional **EasyGen™** Application Generator or the **DS for Formula™** software package, developers can easily customize applications according to the end user specific needs, solving the most common data collection applications such as inventory, picking and shipping/receiving.

**EasyGen™** is the ideal solution for making Formula 734-E batch terminals productive instantly. In a familiar environment, developers have all the instruments at their disposal to reduce programming times (and therefore costs) while maintaining a high standard of quality in the creation of personalized applications whatever their nature, whether simple (e.g. a program for inserting codes/quantities) or more sophisticated.

The **EasyGen™** package includes **Systools™ 2001**, the efficient software utility to transfer data to standard ASCII files, and **OLE for Formula**, the software module ActiveX - OLE Custom Control or OCX - allowing users to easily integrate their data into applications such as Visual Basic, Excel, Access, Delphi, etc (see par. 1.2 or par. 1.3 for details).

**DS for Formula™** is a software package that provides instruments for fully exploiting **F734-E** and **F734-E/RF** terminals by creating fully-structured and personalized applications (see par. 1.2 for details).

DS for Formula™ uses a «C» standard ANSI compiler, integrated with special libraries, operating in an MS-DOS environment and developed specifically for the type of terminal processor. The libraries, developed by Datalogic Mobile, permit direct management of the terminal functions. For example, the management of barcode reading devices is immediate and rational thanks to interaction with functions that automatically start up the barcode acquisition procedure.

Equally transparent, by using a philosophy of events programming, is the procedure managing the keyboard, display, serial and radio-frequency communication, calendar/clock and, either directly or through a vdisk function, the data memory organized into banks.

DS for Formula™ also offers a series of effective general purpose application examples which represent an excellent starting point while simultaneously providing a practical guide for studying and working on complex or personalized programs. Refer to the "Tools" paragraph in the DS for Formula™ Manual for details.

### 1.3 DOWNLOADING EASYGEN™ DEMO

By logging on to [www.mobile.datalogic.com](http://www.mobile.datalogic.com), you can download for free the EasyGen™ Demo Software package containing the following items:

- EasyGen™ Demo Version (user-friendly and highly productive application generator)
- SysTools™2001 (efficient utility for data exchange with the terminal)
- OLE for Formula (useful ActiveX software module for easy integration of Windows applications)
- The most common application examples (data collection, inventory, goods picking, assisted sales) available in 5 languages (English, French, German, Italian, Spanish)
- The complete documentation in PDF format.

## 1.4 PACKAGE CONTENTS

The F734-E terminal package includes:

- n. 1 F734-E terminal complete with batteries;
- n. 1 user's manual
- n. 1 test chart

The F734-E/RF terminal package includes:

- n. 1 F734-E/RF terminal complete with batteries;
- n. 1 user's manual
- n. 1 test chart



**CAUTION**

*Remove all components from their packing and check that they are in good condition and that they correspond to the shipment documents.*

*Keep the packing and boxes in case it is necessary to send the terminal back for technical assistance. Damage caused by improper packing is not covered by the warranty*



**NOTE**

*Rechargeable battery packs are not initially charged. Therefore the first operation to perform is to charge them in the appropriate cradle (see par. 2.2.1 and par. 4.1).*

## 1.5 ACCESSORIES

- F951/C**  
Charger
- F951 – F951 Dark**  
Transceiver/Charger - RS232/RS485
- F951/V**  
Vehicle Transceiver/Charger RS232/RS485 (without power supply)
- F950/4/C**  
Charger - 4 slots
- F950/4**  
Transceiver/Charger - 4 slots - RS232 (x1) / RS485 (x4)
- F950/4/RS232**  
Transceiver/Charger - 4 slots - RS232 with NCK for RS485
- F902**  
T-Box

- NCK**  
RS485 Network/PC connection kit
- FBK73X-E**  
Battery Kit NiMh F734-E
- FBS73X-E**  
Battery Kit NiMh F734-E (5 pcs pack)
- FCB232 D 25 F**  
RS232 serial connection cable PC/XT T 8 M - D25 F 2 m
- FCB232 D 9 F**  
RS232 serial connection cable for PC/AT T 8 M - D9 F 2 m
- FCB485 SYS**  
RS485 serial connection cable for SYSNET 2 m
- FCB EAV**  
Eavesdrop cable kit 2+2 m
- Rubber Cover**  
Rubber protection cover F732-E/F734-E Batch
- Functional Case** – order number 94ACC1266
  
- Belt Holster** – order number 94ACC1268  
F734-E Holster with swivel
- DS for Formula™**  
Development system for Formula Basic Line
- CA51**  
Compiler 8051 Compiler kit V7 for F6XX and F7XX
- EasyGen™**  
Easy application generator package for Formula batch terminals: F660-E, F725-E, F732-E, F734-E
- Utility Tools Full Pack Adv. Ed. F734-E**  
Software package for Windows 95, 98, NT
- ForWin™**  
Software package for developing RF terminal applications
- STARGATE™**  
Radio base station allowing data transmission in wireless network
- STAR★Modem™**  
Radio modem providing wireless RF communication
- STAR-Box™**  
Connection box



## 2 CONNECTIONS

### 2.1 CRADLE

To make the F734-E series terminal operative, it is necessary to insert it into the Formula 951 Transceiver Charger cradle or into the Formula 950/4 Multi Transceiver Charger which has been previously connected to the power supply and to a host computer with an available RS232, RS485 or Eavesdrop line.

The following figure describes the F951 cradle:

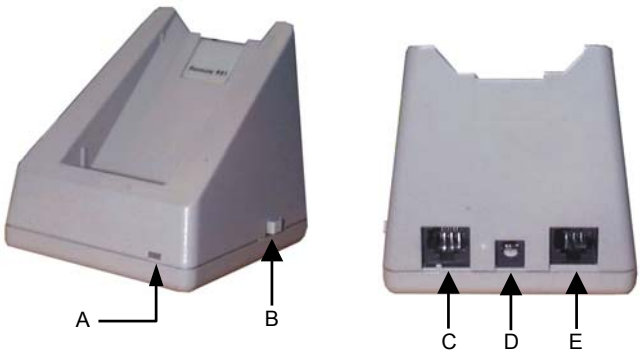

Figure 6 - F951 Cradle Overview

Key:

- A) Red/Green LED:  
Green = terminal not inserted or charge level being maintained  
Red = charge in progress
- B) Cradle on/off switch
- C) RJ connector for RS485 and Eavesdrop connection
- D) Power jack (9 V)
- E) RJ connector for RS232 and RS485 host connection



**CAUTION**

*The use of cradles other than those expressly specified may damage the terminal.*

## 2.2 CONNECTION TO THE HOST COMPUTER



**CAUTION**

*Before proceeding with this phase, make sure that both the computer and the terminal are switched off.*

### 2.2.1 RS232 Connection

To connect the F951 cradle to the host computer, proceed as indicated below:

- 1- Connect the cable to the serial port of the host computer.
- 2- Connect the other end of the same cable (RJ connector) to the RS232 port of the cradle (point E in the previous figure).
- 3- Insert the power-supply plug into the jack on the base of the cradle (point D in the previous figure).
- 4- Attach the power supply to a power outlet.
- 5- Turn on the cradle (point B in the previous figure) and the computer.
- 6- Put the F734-E terminal into the cradle and, if necessary, wait for battery recharging.

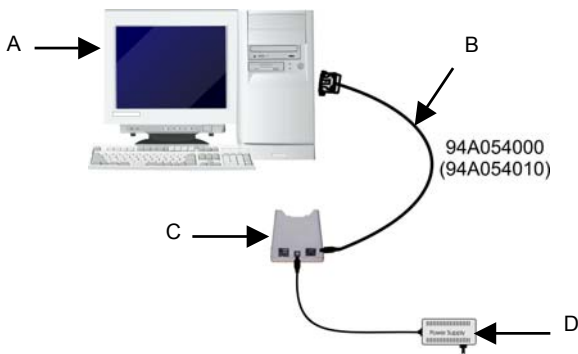

**Figure 7 - RS232 Single Cradle Connection**

Key:

- A) Host computer
- B) Serial cable
- C) Single cradle F951
- D) Power supply

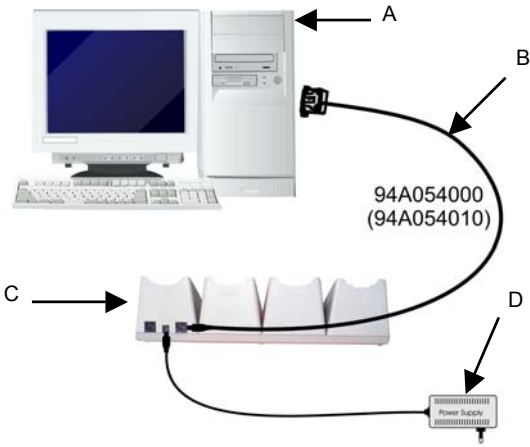

**Figure 8 - RS232 Multi Cradle Connection**

Key:

- A) Host computer
- B) Serial cable
- C) Multi-cradle F950/4
- D) Power supply



**NOTE**

*The RS232 connection allows transmission between the host computer and the first station of the multi-cradle. For this reason, it is necessary to insert an RS232/RS485 converter between the host and the cradle to enable transmission with all the four stations.*

## 2.2.2 Connection with Eavesdrop Interface

The cable Kit 94A054030 provides two cables; one for Eavesdrop connections and one for Modem connections.

The Eavesdrop connection enables the F734-E terminal to be connected to an existing asynchronous RS232 line (for example between the host computer and video terminal).

The modem connection enables the terminal to be connected to a host system using a modem.

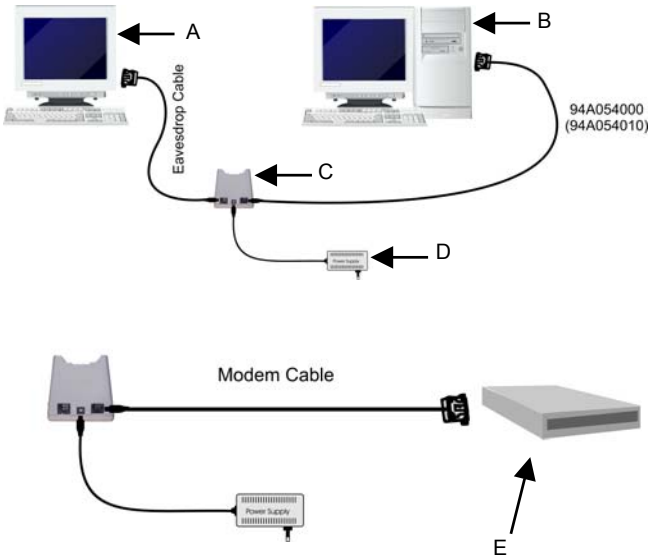

Figure 9 - Eavesdrop and Modem Connection

Key:

- A) Video terminal
- B) Host computer
- C) Cradle F951
- D) Power supply
- E) Modem

### 2.2.3 RS485 Connection

The RS485 line allows connecting several terminals to a single RS232 line by means of a network (see the "Formula 904/N User Manual").

If the network is made using the Formula 902 T-Box, the line can be extended up to 1200 meters and up to 32 different types of Formula cradles can be connected. If multiple cradles are used, the individual work stations must be counted.

**NOTE**

*The RS485 connection is the only one allowing all the stations of a multi-cradle to be available for transmission/reception from the host computer.*

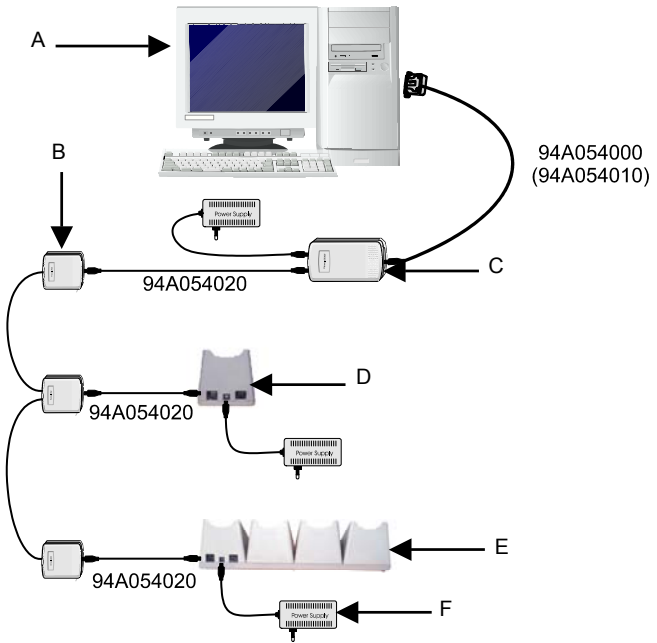

**Figure 10 - RS485 Connection**

**Key:**

- A) Host computer
- B) Formula 902 T-box
- C) Formula 904/N Interconverter
- D) Single cradle F951
- E) Multi cradle F950/4
- F) Power supply

## 2.2.4 RF Connection

The RF connection allows the F734-E/RF terminal to communicate with the host via radio frequency using the STARGATE™ RF base station connected to the host computer.

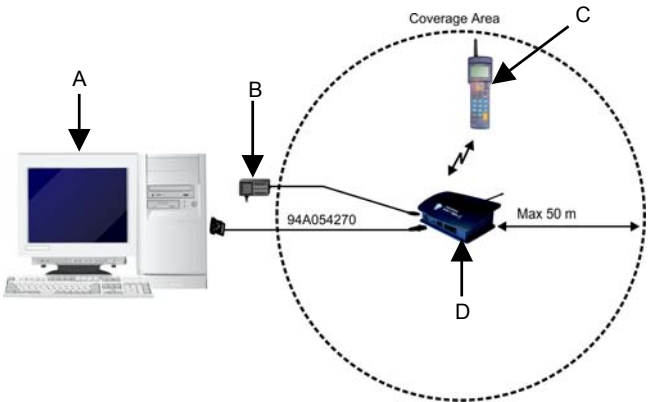

Figure 11 - RF Connection

Key:

- A) Host computer
- B) Power supply
- C) F734-E/RF terminal
- D) STARGATE™ RF base station

## 2.3 CONNECTION CABLE

Several types of cables are provided depending on the computer and on the connection.

The following cables and cable Kits are listed with their order number.

- **RS232 Connection with PC/AT or compatible: cable 94A054000**

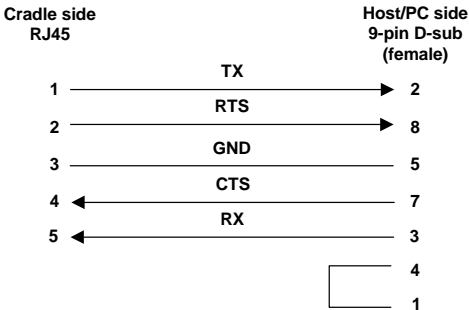

Figure 12 - RS232 Cable Pinout

- **Modem and/or Eavesdrop Connection: cable Kit 94A054030**

The **beige** cable allowing the Eavesdrop connection has the following pinout::

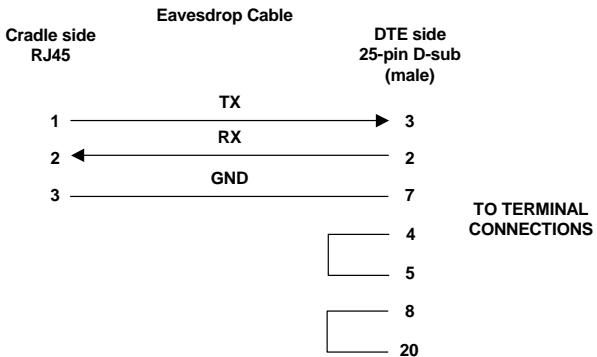

Figure 13 - Eavesdrop Cable Pinout



The **black flat** cable allowing the Modem connection has the following pinout:

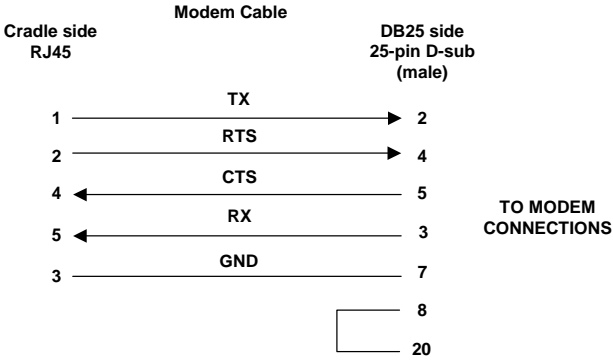

Figure 14 - Modem Cable Pinout

□ RS485 Connection: cable 94A054020

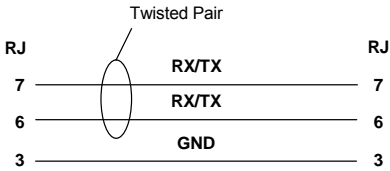

Figure 15 - RS485 Cable Pinout

## 3 USE AND OPERATION

The F734-E and F734-E/RF are lightweight, pocket-sized and fully programmable terminals with 512 KB (512/1024 KB for F734-E model) of RAM memory to manage large databases and 512 KB of Flash memory for application programs of large dimensions.



### NOTE

*It is necessary to load an application program onto the terminal to exploit its features.*

By using the optional EasyGen™ Application Generator or the DS for Formula™ software package, developers can easily customize applications according to the end user specific needs, solving the most common data collection applications such as inventory, picking and shipping/receiving.

The Demo Version of EasyGen™ can be downloaded free of charge from the Datalogic Mobile web site together with 5 ready-to-use example applications in 5 different languages. Refer to chapter 6 of the EasyGen™ User's Manual for details.

The following descriptions assume the terminal is loaded with an EasyGen™ application. If however, a custom application is loaded then refer to the specific documentation for terminal operation.

### 3.1 DESCRIPTION OF KEYS USING EASYGEN™

It is possible to assign customized functions to function keys depending on the application program developed. The functions described below refer to a terminal using an application program developed with the EasyGen™ Application Generator.



### CAUTION

*Refer to chapter 6 "EasyGen™ Interpreter Program" of the EasyGen™ User's Manual for more details about the key functions.*



### NOTE

*Every time a key is pressed, the F734-E series terminal remains turned on for a maximum of 20 seconds.*



ARROW KEYS: only available for the application when not in "Select or Data Edit" mode.



SCAN KEY: activates the laser for barcode scanning and turns on the terminal when it is off.



FUNCTION KEYS: keys <F1>, <F2>, <F3> and <F4> are available for the loaded application. Function F5 activates the "Select" mode and only in this mode you can use F6, F7 and F8 functions:

<SHIFT> followed by <F1> = F5  
"Select" mode  
<SHIFT> followed by <F2> = F6  
Data search  
<SHIFT> followed by <F3> = F7  
Deletion  
<SHIFT> followed by <F4> = F8  
Data display



ESC KEY: used in the "Data display" mode.



SHIFT KEY: Enables the entry of alphabetical characters (written in white on the keyboard) when followed by the pressing of a numeric key: for example if you want to enter the alphabetical character "A", you have to press <SHIFT>+<7>.

The number of times the SHIFT key is pressed determines the choice of alphabetical character: for example if you want to enter the alphabetical character "N", you have to press <SHIFT>+<SHIFT>+<5>, if you want to enter the alphabetical character "X", you have to press <SHIFT>+<SHIFT>+<SHIFT>+<2> and so on.

The fourth time the SHIFT key is pressed, the SHIFT function is disabled. The SHIFT function can also be disabled by waiting for a time-out of 2 seconds after being pressed.



By pressing the <SHIFT> key followed by the <RIGHT ARROW> key, the graphic

display's contrast increases to the allowed maximum, and then returns to 0 value.



**NUMERIC KEYS:** allow the entry and display of the main numeric symbol. If the <SHIFT> has first been pressed, the choice of alternative alphabetic characters will be activated.



**BACKSPACE KEY:** deletes the last character entered.



**SPACE KEY:** allows the introduction of a blank space. If the <SHIFT> has been pressed previously, the choice of alternative characters will be activated.



**ENTER KEY:** allows validation of what has been typed.



**PROTECTED RESET BUTTON:** it is activated by inserting a blunt object in the slot while simultaneously pressing the <SCAN> key.

## 3.2 BARCODE SCANNING

When reading a barcode point the terminal laser beam at the code from an appropriate distance and simultaneously press the <SCAN> key. The beam emitted by the laser must completely cover the barcode; the LED (and the acoustic signal, if activated) will indicate if the scan was carried out correctly.

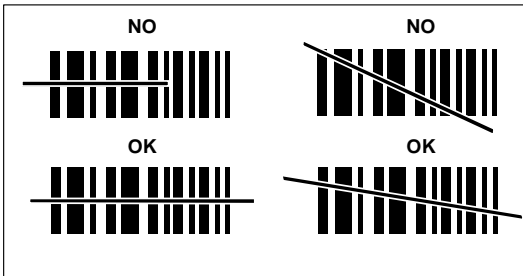



Figure 16 - F734-E Series Terminal Scanning a Barcode



### NOTE

Throughout the operation of the application, the battery icon , and the time icon will always be activated, the latter in accordance with the setting of the terminal internal clock.

In addition, when an acoustic signal is emitted, the loudspeaker icon  will appear.

### 3.3 DELETING THE APPLICATION PROGRAM

This procedure allows deleting application programs developed with DS for Formula™. If you want to delete programs provided or developed by EasyGen™, refer to chapter 6 of the EasyGen™ manual.



#### NOTE

*The following procedure causes data to be deleted even if not completed.*

If the application program must be cancelled follow the instructions below:

- 1- Press the <SCAN> key and the protected reset button at the same time; the display will show:

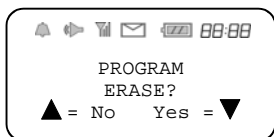

#### NOTE

*If you do not want to delete the application program, press the {▲} or wait about 25 seconds.*

- 2- To continue with the deletion, press the ▼ key; after a few seconds, the display will show:

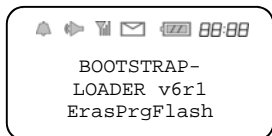

- 3- Once the deletion procedure is completed, the terminal is ready to receive a new application program. This is installed using the methods described in the DS for Formula™ manual.

### 3.4 DOWNLOADING DATA TO HOST

Data can be downloaded from the terminal to the host PC in different ways, depending on the application loaded and on the terminal model.

If working with F734-E (batch model), the application software allows downloading data onto the PC by simply inserting the terminal into the cradle or by direct operator intervention on the terminal or host computer.



Figure 17 - Downloading Data with F734-E

If working with F734-E/RF, the application software will allow downloading data by radio frequency transmission between the terminal and a STARGATE™ RF base station.

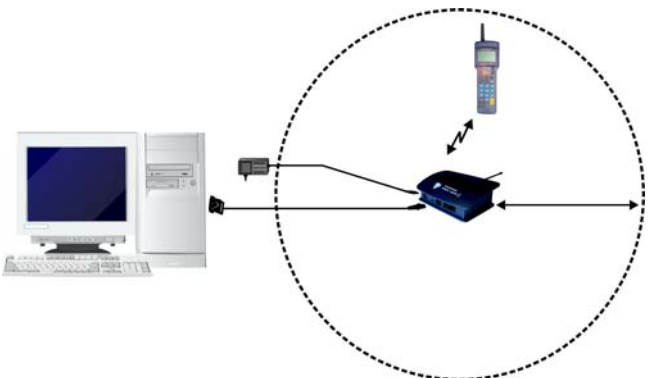

Figure 18 - Downloading Data with F734-E/RF

## 4 MAINTENANCE



### NOTE

*Rechargeable battery packs (NiCd/NiMh) are not initially charged. Therefore the first operation to perform is to charge them in the appropriate cradle. See chapter 2 and the following paragraph "Charging the Batteries".*

### 4.1 CHARGING THE BATTERIES

Battery charge life depends on many variables but, under normal conditions, autonomy is more than enough for a day work.

Information on the battery-charge status is provided by the dedicated icon on the display . The information provided by the icon is valid only when the terminal is not inserted in the cradle.

Four different charge levels are given from a maximum value (all the icon segments full) to a minimum one which warns of pre-low-battery (icon empty and intermittently flashing).

Recharging should be made after using the terminal until the batteries are nearly flat.



### CAUTION

*When the terminal display window shows the message "BATTERY LOW", wait until it is turned off before inserting it in the cradle.*

Recharge the terminal by simply inserting it into its cradle; Datalogic Mobile S.r.l. recommends a minimum uninterrupted recharging time of eight hours. When using the NiMh battery a standard recharge does not allow taking fully advantage of the improved battery technology. For this reason, a recharging time of about 60 hours is advised to get the NiMh maximum capacity.

When batteries are new, or have not been recharged for a long time, it is necessary to perform two or three charge and discharge cycles (with complete use) before the batteries are able to reach their maximum capacity.



**NOTE**

*During the battery recharge the color of the LED positioned on the cradle changes from red to green. If using the NiCd battery pack, the LED color changes when 70-80% of the complete charge is reached. If using the NiMh battery pack, the LED color changes when 50-60% of the complete charge is reached due to the battery increased capacity.*

**CAUTION**

*If the terminal remains inactive for a prolonged period such as two weeks, it is advisable to download all the stored data onto a computer and extract the battery pack.*

## 4.2 REPLACING THE BATTERIES



**CAUTION**

Before proceeding, ensure that the terminal is switched off and that the data it contains has been downloaded onto the host computer.



To replace the batteries correctly, proceed as follows.

- 1- Turn over the terminal and remove the two battery cover screws.



- 2- Lift the battery cover as shown in the figure and extract the old battery pack.



- 3- Replace the battery pack, making sure the batteries are inserted in the right direction as indicated within the case.



**CAUTION**

*Before inserting the battery pack into the terminal, ensure the battery polarity matches with the one indicated within the case.*

**Figure 19****Figure 20****CAUTION**

*When inserting the battery pack, first slide it towards the springs compressing them until the contacts at the other end are cleared (see Figure 18). Then, push downwards to insert the pack (see Figure 19). Be very careful not to damage the contacts when pushing downwards.*

- 4- Close the battery cover and tighten the screws

**WARNING**

*Do not incinerate, disassemble, short terminals or expose to high temperature. Risk of fire, explosion. Use specified charger only. Risk of explosion if the battery is replaced by an incorrect type. Dispose of the batteries as required by the relevant laws in force.*

### **4.3 CLEANING THE TERMINAL**

Clean the terminal from time to time with a slightly damp cloth. Do not use alcohol, corrosive products or solvents.

## 5 TROUBLESHOOTING

PROBLEM	CAUSE	REMEDY
When the <SCAN> button is pressed the terminal does not come on.	Flat batteries.	Recharge terminal.
	Batteries completely flat or broken.	Replace batteries.
When the <SCAN> button is pressed, the terminal displays the message BATTERY LOW and switches itself off.	Flat batteries.	Recharge terminal.
	Batteries completely flat or broken.	Replace batteries.
The terminal does not load the application program.	There is no power supply to the cradle.	Connect the power supply and switch on the cradle.
	The serial cable is not correctly connected.	Check the connection to the cradle and the serial port of the computer.
	The terminal already contains an application program.	Follow instructions to cancel the application.
The terminal displays an error message FAULT CODE.P21CO4.	The application loaded is not suitable for the terminal in use. The terminal displays the message FAULT CODE P21CO4.	Load the correct application program.
	Other faults. The terminal displays an error message other than FAULT CODE P21 CO4.	Contact your Datalogic Mobile representative for technical assistance.

## 6 TECHNICAL FEATURES

	F734-E	F734-E/RF
<b>Optical Features</b>		
Light source	Laser-scanner; VLD source; 630-680nm	
Scan rate	35±5 scans/sec	
Minimum resolution	0.15 mm / 6 mils	
Skew angle	± 65°	
Pitch angle	± 65°	
Depth of field	30 to 700 mm / 1.2 to 27.6 in (depends on the density of the code)	
<b>Electrical Features</b>		
Micro-controller	8-bit CMOS 8 KB bootstrap-loader PROM	
Program memory	512 KB Flash-memory	
Data RAM	512/1024 KB SRAM	512 KB SRAM
EEPROM	256 bytes	
Calendar/clock	Quartz RT, programmable date and time with automatic handling of leap years.	
Power supply	4 NiCd 250mA/h batteries	4 NiMh 650 mA/h batteries
Battery charger	Formula 951 or Formula 950/4	
<b>Physical Features</b>		
Technology	SMT (Surface Mount Technology)	
Dimensions (LxWxH)	165x56x34 mm 6.5x2.2x1.3 mil	209x56x37 mm 8.2x2.2x1.5 in (with antenna)
Weight	200 g / 7.05 oz (with battery)	215 g / 7.6 oz (with battery)
Buzzer	Piezoelectric, programmable in frequency and duration	
LED	Programmable red/green LED	
Display	High contrast, back-lit LCD graphic display with 97 x 32 matrix	
Keyboard	25 silicone rubber keys, reset button	
<b>Environmental Features</b>		
Working temperature	0 °C to +50 °C (32 °F to +122 °F)	
Storage temperature	-20 °C to +70 °C (-4 °F to +158 °F)	
Relative humidity	95% without condensation	
Degree of protection	Protected from rain and dust	

<b>Environmental Features</b>	
Electrostatic charges	IEC 801-2
Drop resistance	IEC 68-2-32 up to 1 m (39 in) onto concrete
Laser safety	EN 60825-1 class 2 laser product
<b>Programming Features</b>	
Barcodes decoded	Standard 3/9 Extended 3/9 Italian pharmaceutical Interleaved 2/5 ITF 14 Industrial 2/5 Matrix 2/5 UPC - EAN UPC only UPC/EAN + Addon 2 UPC/EAN + Addon 5 UPC-E only UPC 8 only UPC-A & EAN 13 only Codabar (NW7) Monarch (2/7) PAKO Code 128 EAN 128 Delta A IBM MSI Code 93 Zellweger Storagetek
Operating modes	bootstrap loader; application program
<b>Transmission Features</b>	
F951 - F950/4 interface	via optical transceiver with serial protocol
Cradle-Host interface	RS232; RS485; Eavesdrop
Transmission speed	300 to 19200 bits/sec
Transmission protocol	Program-definable
Transmission modes	RS232 full-duplex; RS485 half-duplex
Parity	mark, space, odd, even
<b>F734-E/RF Transmission Features</b>	
Frequency	433.92 MHz
Power emitted	10 mW Max

# GLOSSARY

---

## **Barcode**

A pattern of variable-width bars and spaces which represents numeric or alphanumeric data in binary form. The general format of a barcode symbol consists of a leading margin, start character, data or message character, check character (if any), stop character, and trailing margin. Within this framework, each recognizable symbology uses its own unique format.

## **Baud Rate**

A measure for data transmission speed.

## **Bit**

Binary digit. One bit is the basic unit of binary information. Generally, eight consecutive bits compose one byte of data. The pattern of 0 and 1 values within the byte determines its meaning.

## **Bits per Second (bps)**

Number of bits transmitted or received per second.

## **Byte**

On an addressable boundary, eight adjacent binary digits (0 and 1) combined in a pattern to represent a specific character or numeric value. Bits are numbered from the right, 0 through 7, with bit 0 the low-order bit. One byte in memory can be used to store one ASCII character.

## **Decode**

To recognize a barcode symbology (e.g., Codabar, Code 128, Code 3 of 9, UPC/EAN, etc.) and analyze the content of the barcode scanned.

## **EEPROM**

Electrically Erasable Programmable Read-Only Memory. An on-board non-volatile memory chip. Data is maintained when power is not present.

## **FLASH**

It is a type of non-volatile memory that can be erased and reprogrammed in units of memory called *blocks*. It is a variation of EEPROM memory which, unlike flash memory, is erased and rewritten at the byte level, and therefore is slower than flash memory updating. Data is maintained when power is not present.



**Host**

A computer that serves other terminals in a network, providing services such as network control, database access, special programs, supervisory programs, or programming languages.

**Liquid Crystal Display (LCD)**

A display that uses liquid crystal sealed between two glass plates. The crystals are excited by precise electrical charges, causing them to reflect light outside according to their bias. They use little electricity and react relatively quickly. They require external light to reflect their information to the user.

**Light Emitting Diode (LED)**

A low power electronic light source commonly used as an indicator light. It uses less power than an incandescent light bulb but more than a Liquid Crystal Display (LCD).

**RAM**

Random Access Memory. Data in RAM can be accessed in random order, and quickly written and read. This memory is volatile and therefore data is lost when power is not present.

**RTC**

Real Time Clock.

**Terminal**

A Datalogic portable computer product.

# INDEX

---

## A

Accessories; 5  
Application Development  
Programs; 3

## B

Barcode Scanning; 19

## C

Connections; 7  
Connection Cable; 14  
Connection with  
Eavesdrop Interface; 10  
Cradle; 7  
RF Connection; 13  
RS232 Connection; 8  
RS485 Connection; 11

## D

Deleting the Application  
Program; 20  
Downloading Data to Host;  
21  
Downloading EasyGen™  
Demo; 4

## G

General View; xvii

## M

Maintenance; 22  
Charging the Batteries; 22  
Cleaning the Terminal; 26  
Replacing the Batteries;  
24

## P

Package Contents; 5  
Patents; xiii

## R

Reference Documentation; v

## S

Safety Regulations; vi  
FCC Compliance; xiii  
Laser Safety; vii  
Radio Compliance; xii  
WEEE Compliance; xiv

## T

Technical Features; 28  
Troubleshooting; 27

## U

Use and Operation; 16

Datalogic Mobile S.r.l.  
Via S. Vitalino 13  
40012 - Lippo di Calderara  
Bologna - Italy



dichiara che  
declares that the  
déclare que le  
bescheinigt, daß das Gerät  
declare que el

**F734-E, Pocket Terminal**  
**F951, Single Transceiver/Charger**  
**F950/4, Multi Transceiver/Charger**

e tutti i suoi modelli  
and all its models  
et tous ses modèles  
und seine Modelle  
y todos sus modelos

sono conformi alle Direttive del Consiglio Europeo sottoelencate:  
are in conformity with the requirements of the European Council Directives listed below:  
sont conformes aux spécifications des Directives de l'Union Européenne ci-dessous:  
den nachstehenden angeführten Direktiven des Europäischen Rats:  
cumple con los requisitos de las Directivas del Consejo Europeo, según la lista siguiente:

**89/336/EEC EMC Directive** e **92/31/EEC, 93/68/EEC** emendamenti successivi  
and further amendments  
et ses successifs amendements  
und spätere Abänderungen  
y sucesivas enmiendas

Basate sulle legislazioni degli Stati membri in relazione alla compatibilità elettromagnetica ed alla sicurezza dei prodotti.

On the approximation of the laws of Member States relating to electromagnetic compatibility and product safety.

Basées sur la législation des États membres relative à la compatibilité électromagnétique et à la sécurité des produits.

Über die Annäherung der Gesetze der Mitgliedsstaaten in bezug auf elektromagnetische Verträglichkeit und Produktsicherheit entsprechen.

Basado en la aproximación de las leyes de los Países Miembros respecto a la compatibilidad electromagnética y las Medidas de seguridad relativas al producto.

---

Questa dichiarazione è basata sulla conformità dei prodotti alle norme seguenti:  
This declaration is based upon compliance of the products to the following standards:  
Cette déclaration repose sur la conformité des produits aux normes suivantes:  
Diese Erklärung basiert darauf, daß das Produkt den folgenden Normen entspricht:  
Esta declaración se basa en el cumplimiento de los productos con las siguientes normas:

**EN 55022 (CLASS B ITE), AUGUST 1994:**  
**AMENDMENT A1 (CLASS B ITE), OCTOBER 2000:**

LIMITS AND METHODS OF MEASUREMENTS OF RADIO DISTURBANCE CHARACTERISTICS OF INFORMATION TECHNOLOGY EQUIPMENT (ITE)

**EN 55024, SEPTEMBER 1998:**

INFORMATION TECHNOLOGY EQUIPMENT, IMMUNITY CHARACTERISTICS. LIMITS AND METHODS OF MEASUREMENTS.

Lippo di Calderara, March 8th, 2007

Paola Chientaroli  
Quality Assurance Manager



[www.mobile.datalogic.com](http://www.mobile.datalogic.com)

**World wide Sales Network**  
**available from: [www.mobile.datalogic.com/contacts](http://www.mobile.datalogic.com/contacts)**

**Datalogic Mobile S.r.l.**

Via S. Vitalino, 13

40012 Lippo di Calderara di Reno

Bologna - Italy

Telephone: (+39) 051-3147011

Fax: (+39) 051-3147561



822000114 (Rev. E)