



# **Xtreme Value Rack Tower Series (XVRT)**

## **User's & Installation Manual**

## TABLE OF CONTENTS

INTRODUCTION .....	2
SAFETY INSTRUCTIONS .....	3
PRODUCT DESCRIPTION .....	5
DETERMINING THE POWER REQUIREMENTS OF YOUR EQUIPMENT .....	10
HARDWARE INSTALLATION GUIDE .....	11
SOFTWARE AND COMPUTER INTERFACE .....	14
REPLACING THE BATTERY .....	16
AUDIBLE ALARMS .....	17
TROUBLESHOOTING .....	17
SPECIFICATIONS.....	18
OBTAINING SERVICE.....	20
XTREME POWER CONVERSION™ (XPC) CORPORATION LIMITED WARRANTY .....	21
APPENDIX A: SNMP CONFIGURATION GUIDE .....	22

## INTRODUCTION

Thank you for selecting this uninterruptible power supply (UPS). It provides you with protection for connected equipment. **Please read this manual** before installing the XVRT-Series UPS models XVRT-1000, XVRT-1500, XVRT-2200 and XVRT-3000 as it provides important information that should be followed during installation and maintenance of the UPS and batteries, allowing you to correctly set up your system for the maximum safety and performance. Included is information on customer support and service, if it is required. If you experience a problem with the UPS, please refer to the Troubleshooting section in this manual to correct the problem. If the problem is not corrected, please collect information so that the Technical Support personnel can more effectively assist you.

## SAFETY INSTRUCTIONS

**ATTENTION:** To safely interact with and enjoy all the features and benefits of these Xtreme Power Conversion Uninterruptible Power Supplies (UPS), please read and follow all installation and operation instructions completely. These UPS are designed to provide power protection for connected electronic equipment.

**CAUTION:** Any changes or modifications not expressly approved by the manufacturer of this device could void the user's authority to operate the equipment.

**FCC Notice:** This equipment has been tested and found to comply with the limits for a Class B Digital Device pursuant to Part 15 of the FCC Rules. These limits are designed to provide reasonable protection against harmful interference in residential installation. This equipment generates and can radiate radio frequency energy and, if not installed and used in accordance with the instructions, may cause harmful interference to radio communications. There is no guarantee that interference will not occur in a particular installation. If this equipment does cause harmful interference to radio or television reception, which can be determined by turning the equipment off and on, the user is encouraged to try to correct the interference by one or more of the following measures:

1. Reorient or relocate the receiving antenna.
2. Increase the separation between the equipment and receiver.
3. Connect the equipment into an outlet on a circuit different from that to which the receiver is connected.
4. Consult the dealer or an experienced technician for help. Any special accessories needed for compliance must be specified in the instruction.

**CAUTION:** A shielded-type power cord is required in order to meet FCC emission limits and to prevent interference to the nearby radio or TV reception. It is essential that only the supplied power cord be used. Use only shielded cables to connect I/O devices to this equipment.

**WARNING:** Any changes or modifications not expressly approved by the manufacturer of this device could void the user's authority to operate the equipment.

## **IMPORTANT SAFETY INSTRUCTIONS: (SAVE THESE INSTRUCTIONS)**

This manual contains important safety instructions. Please read and follow ALL instructions carefully during the installation and operation of the UPS and Batteries. Read this manual thoroughly before attempting to unpack, install or operate.

This UPS is intended for Installation in a Controlled Environment.

**CAUTION!** To prevent the risk of fire or electric shock, install in a temperature and humidity controlled indoor area, free of conductive contaminants. (Please see specifications for acceptable temperature and humidity range).

**CAUTION!** To reduce the risk of electric shock, do not remove the UPS cover. Qualified Service Personnel must perform ALL repairs and maintenance. No user serviceable parts inside.

**CAUTION!** Hazardous live parts inside can be energized by the battery even when the AC input power is disconnected.

**CAUTION!** UPS must be connected to an AC power outlet with fuse or circuit breaker protection. Do not plug into an AC wall outlet that is not grounded. If you need to de-energize this equipment, turn off and unplug the UPS.

**CAUTION!** Servicing of batteries should be performed or supervised by personnel knowledgeable of batteries and their required precautions. Keep unauthorized personnel away from batteries and always replace batteries with the quantity and type. See Page 15 of this manual for more safety details.

**DO NOT USE FOR MEDICAL OR LIFE SUPPORT EQUIPMENT!** Xtreme Power does not sell products for life support or medical applications. DO NOT use these UPS in any circumstances that would affect operation or safety of any life support equipment or with any medical applications or patient care.

**DO NOT USE WITH OR NEAR AQUARIUMS!** To reduce the risk of fire or electric shock, do not use with or near an aquarium. Condensation from the aquarium can cause the UPS to short out.

### **Storage**

To store the UPS, cover it and store it with the battery fully charged. During extended storage, recharge the battery every three months to ensure battery life.

## PRODUCT DESCRIPTION

Many different kinds of sensitive electrical equipment can be protected by an Uninterruptible Power Supply (UPS) including computers, workstations, process control systems, telecommunications systems, sales terminals, other critical instrumentation, etc. The purpose of the UPS is to protect these systems from poor quality utility power, complete loss of power, or other associated problems.

Electrical interference exists in many forms, causing problems in AC power, from lightning, power company accidents and radio transmission motors, air conditioners, and vending machines. Protection of sensitive electrical equipment is vital to protect against power outages, low or high voltage conditions, slow voltage fluctuations, frequency variations, differential and common-mode noise, transients, etc.

To prevent power line problems from reaching critical systems causing damage to software, hardware, and equipment malfunctions, the UPS maintains constant voltage, isolating critical load output and cleaning the utility AC power.

## Line-Interactive Technology

A line-interactive technology UPS provides basic power protection and Automatic Voltage Regulation (AVR) to the load when AC input power is available. When AC input power is unavailable, the line-interactive UPS will switch to batteries to supply the load with power. In the event that the power failure lasts longer than the UPS backup time, the UPS will shut down avoiding battery damage. When the input AC voltage returns, the UPS will automatically return online to recharge the batteries.

As shown in the diagram:

- AC input flows into and through the AVR to the load.
- When AC input varies outside the acceptable specification, the AVR switches taps on the transformer to better regulate the output.
- If AC input power fails, the inverter turns on and supplies power from the batteries to the load.
- When AC input power returns, the UPS automatically begins supplying the load with power through the AVR circuit.
- The charger circuit provides recharge for the batteries.

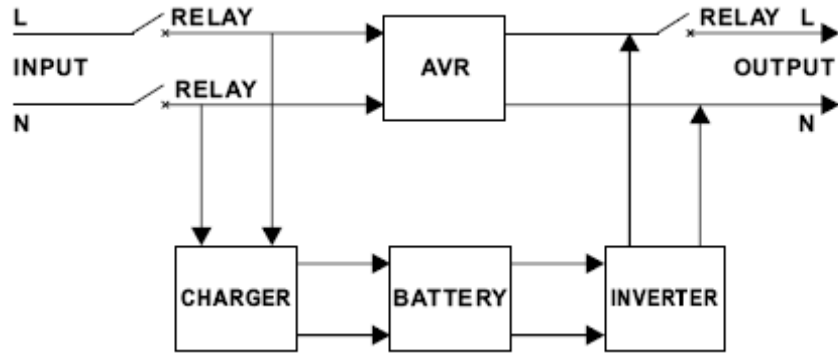

FRONT PANEL XVRT-1000, 1U HEIGHT

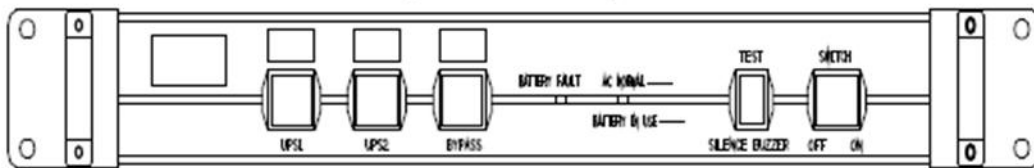

REAR PANEL XVRT-1000, 1U HEIGHT

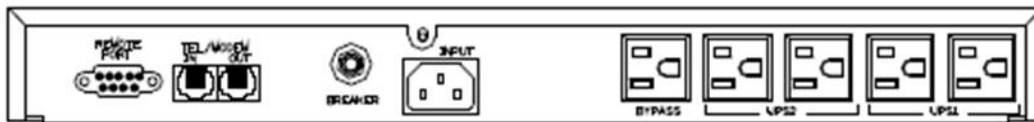

FRONT PANEL XVRT-1500, 2U HEIGHT



REAR PANEL XVRT-1500, 2U HEIGHT

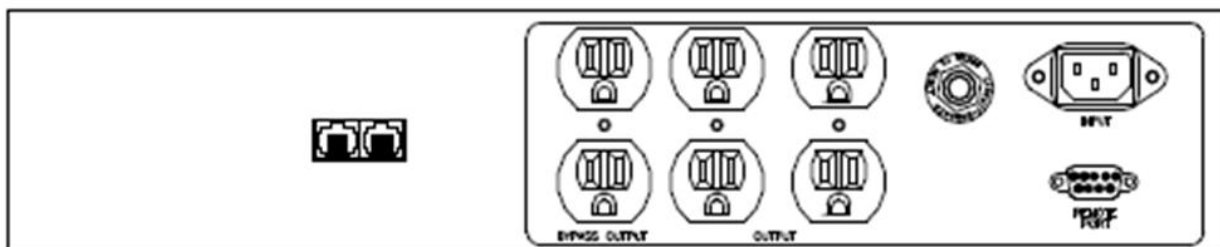

FRONT PANEL XVRT-2200/XVRT-3000, 3U HEIGHT

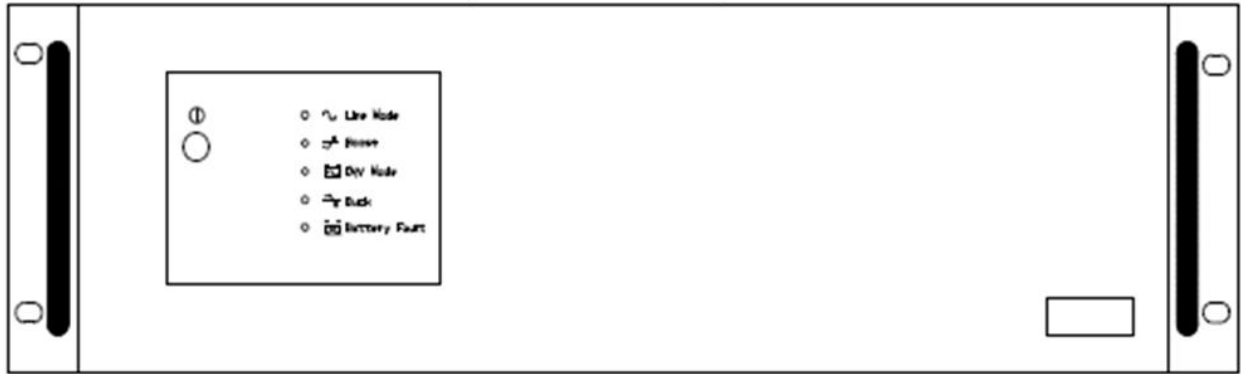

REAR PANEL XVRT-2200, 3U HEIGHT

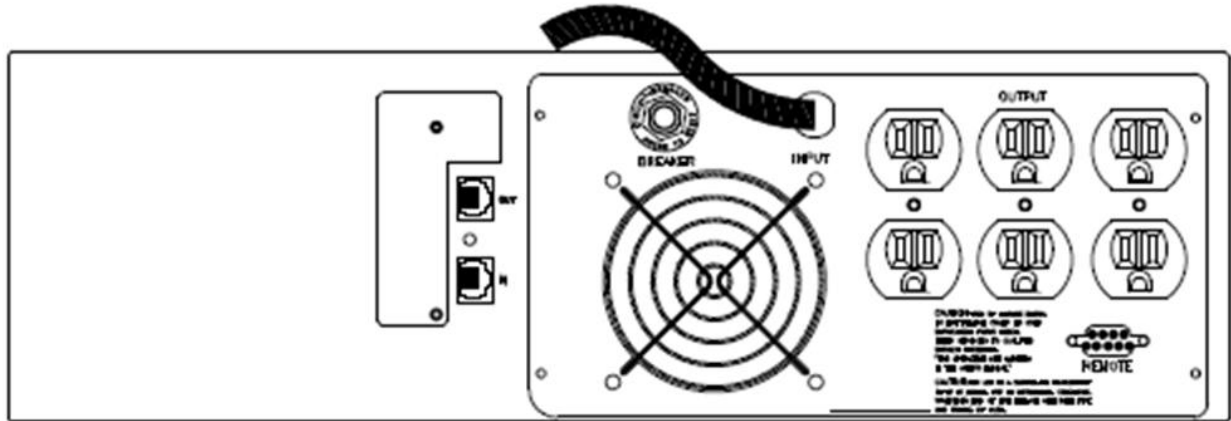

REAR PANEL XVRT-3000, 3U HEIGHT

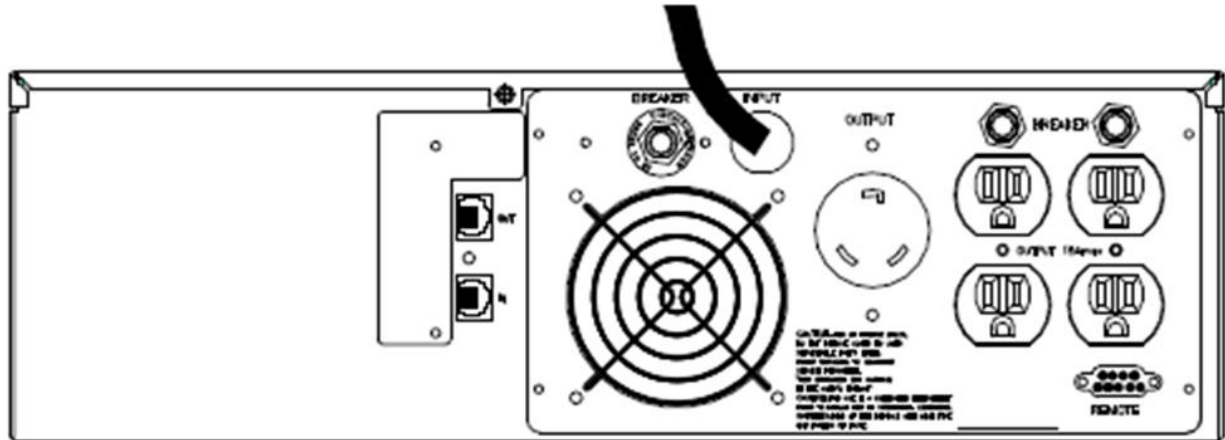



XVRT-1000 FRONT PANEL



XVRT-1500-2200-3000 FRONT PANEL

### **“AC NORMAL” or “LINE MODE” Indicator**

The AC Normal (XVRT-1000) or Line Mode (XVRT-1500, XVRT-2200, XVRT-3000) indicator illuminates when utility power's condition is normal.

### **“BATTERY IN USE” or “INV MODE” Indicator**

The Battery in Use (XVRT-1000) or Inv Mode (XVRT-1500, XVRT-2200, XVRT-3000) indicator illuminates when the power is supplied from the batteries.

### **“BATTERY FAULT” Indicator**

This illuminates indicating weak battery. Recharge the battery for at least four hours. If after recharging this is still illuminated, replace the battery by following the instructions in the manual.

### **“BOOST” Indicator**



This illuminates when input voltage is too low and the UPS is boosting the voltage via the Automatic Voltage Regulation (AVR) circuit.

## **“BUCK” Indicator**

This illuminates when input voltage is too high and the UPS is lowering the voltage via the Automatic Voltage Regulation (AVR) circuit.

## **Power Switch**

The Power Switch can be used as the master on/off switch of your equipment by leaving your equipment connected to the UPS and switched on.

## **UPS Outlets**

The UPS Outlets provide instantaneous backup power protection to your equipment. They can also be used to supply temporary uninterrupted operation for your equipment during a power failure.

## **Bypass / Power Sag Outlets**

The Bypass or Power Sag Outlet provides bypass power sag protection to your equipment. Prevent power problems traveling through your system via unprotected peripherals.

## **Circuit Breaker Protection**

The Circuit Breaker serves as an overload and fault protection, a critical component of this advanced UPS.

## **Tel/Data Protection Ports**

The Telephone/Data Protection Ports provide users surge protection via 1 in 1 out RJ45 jack.

**Caution:** To reduce risk of fire, use only 26AWG or larger telecommunication line cord.

## **Communication Function**

A RS232 interface and UPSMON software is provided to support communications with NOVELL, UNIX, DOS, WINDOWS, and other operating systems.

## DETERMINING THE POWER REQUIREMENTS OF YOUR EQUIPMENT

1. Make sure the total Volt-Amp (VA) requirements of your connected equipment does not exceed the maximum VA rating for the UPS. The maximum VA ratings are shown in the Specifications section of this document.
2. Ensure that the equipment plugged into the battery-powered outlets does not exceed the UPS rated capacity. If UPS rated capacities are exceeded, an overload condition may occur and cause the UPS to shut down and trip the circuit breaker.
3. If the power requirements of your equipment are listed in values other than Volt-Amps (VA), convert Watts (W) or Amps (A) into VA by doing the calculations below. Note: The equation below only calculates the maximum amount of VA that the equipment can use, not what is typically used by the equipment at any given time. Users should expect usage requirements to be approximately 60% of the value to estimate power requirements:

$$\underline{\hspace{2cm}} \text{ Watts (W) } \times 1.67 = \underline{\hspace{2cm}} \text{ VA or } \underline{\hspace{2cm}} \text{ Amps (A) } \times 120 = \underline{\hspace{2cm}} \text{ VA}$$

Add the totals for all of the equipment and multiply this total by 0.65 to calculate actual power requirements.

**Note:** Many factors can affect the amount of power that your computer system will require. The total load that you will be placing on the battery-powered outlets should not exceed 85% of the UPS capacity.

## HARDWARE INSTALLATION GUIDE

Inspect the UPS upon receipt. The packaging is recyclable; keep it for reuse or dispose of properly.

### Installation of Rack-mount accessories

Install the rack-mount type units according to the following illustrations.

#### Vertical Tower Configuration

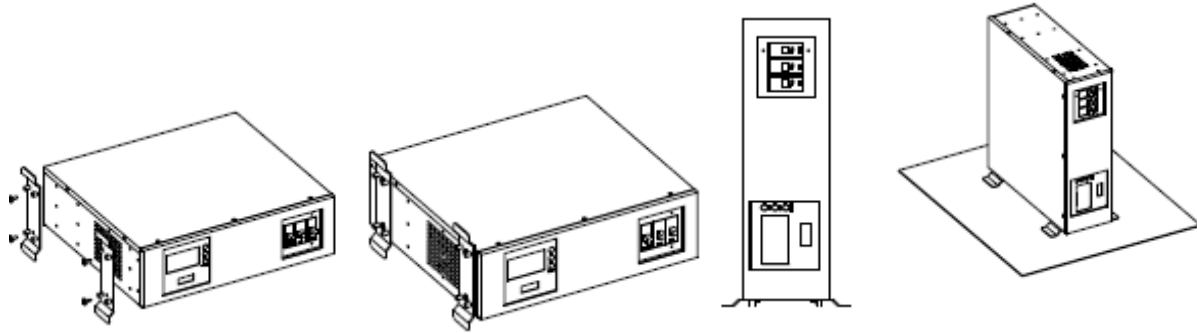

#### Wall Mount Configuration

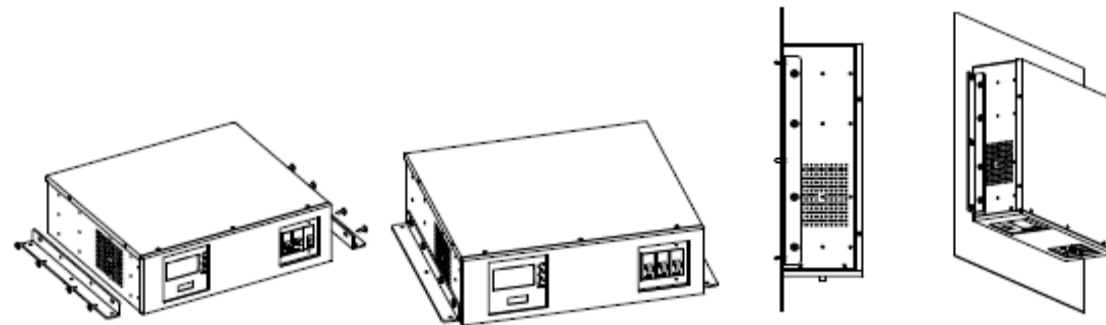

#### Horizontal Stacked Configuration

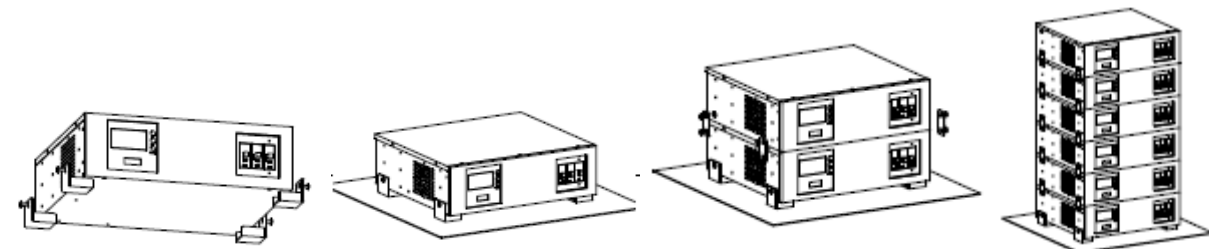

## **Connections and Startup:**

### **1. Connect to Utility Power**

Plug the UPS into a 3-wire grounded receptacle of proper size per UPS specifications. Make sure the receptacle is protected by the proper size fuse or circuit breaker, and is not located on the same circuit with equipment requiring higher amounts of power (e.g. refrigerator, air conditioner, copier). Avoid using an extension cord to connect the UPS to the input power receptacle.

**NOTE: *Size of Branch Circuit Over-current Protection – CAUTION – to reduce the risk of fire, connect only to a circuit provided with 30 amperes maximum branch circuit over-current protection in accordance with National Electric Code, ANSI/NFPA 70.***

### **2. Start the UPS**

Turn the UPS on by pushing the Power switch button on the front of the UPS. The UPS will conduct a self-test once connected to input power and the power switch turned ON. DO NOT add or remove equipment from the output of the UPS while the UPS is conducting its self-test. Wait until the Power indicator illuminates to add additional equipment.

#### **Battery Auto-Charging**

Once the input power cord is connected to AC, the battery in the UPS will automatically be charged by the UPS. To maintain the optimal battery status, make sure the UPS remains plugged into AC input power. The battery is fully charged before shipping. However, it is recommended that the battery be recharged for at least eight hours before using. Energy loss may occur during shipping or long duration storage. Equipment loads can be connected during this time; however the battery capacity may not be 100% until charging is complete.

### **3. Connect Software**

- Configure the UPSMON local monitoring software.
  1. Insert the UPSMON CD (included with UPS packaging) into the CD ROM of the local computer.
  2. Select the appropriate installation from the Autorun menu.
  3. Follow the setup instructions. Click finish when prompted. Ensure the checkbox to start UPSMON is checked before clicking finish.
  4. The UPSMON icon will appear in the system tray of the desktop near the system clock. Double click this icon to enlarge the program window.
  5. Connect the USB or RS232 cable (included in the UPS packaging) to the Computer and UPS. Communication should start momentarily. If it does not, click on Setup on UPSMON toolbar, then select Comport, and search computer ports.

**CAUTION:** Please verify the UPSMON shutdown settings of the UPS and Local PC by clicking on System/System configuration.

6. Click on Help in UPSMON toolbar for further software configuration.
- Connect the optional external SNMP card if purchased. See Appendix A for configuration details.

## 4. Connect the Loads

Plug your equipment (e.g. computer, monitor, critical data storage device, etc.) into the Battery Power supplied outlets. Plug your peripheral equipment (e.g. printer, scanner, fax, audio device) to the Bypass outlet(s). Do not plug a laser printer into the UPS output outlets, as its power demand is much higher than typical peripherals and may cause the circuit breaker to trip. It is suggested that laser printers and other heavy loads be connected to the Bypass outlets.

## 5. Connect Telephone or Data Device

If you wish to protect a fax, modem or other telephone or data networking device, plug the cable from the wall into the "IN" jack. Connect the cable provided with the UPS from the "OUT" jack to the fax, modem, or other networking device. To protect a 10Base-T (UTP) network interface, obtain and use a UTP cable to connect the "OUT" jack to your computer.

## 6. Test

It is recommended that the user perform a simulation test when using the UPS for the first time or when adding an additional piece of equipment to verify actual load levels.

Conduct a simulation-test:

1. Switch the UPS ON
2. Wait for the Power Indicator to light up
3. Unplug the UPS to simulate a utility failure to verify loads via software
4. Return utility power

When utility failure occurs, the UPS output outlets will supply power to your equipment from its battery, and the alarm will beep every 5 seconds. Be sure that your equipment is running under the limited rating power. The XVRT measures the Volt-AMP (VA) rating of the load while on Utility, and the Watt (W) rating of the load when on battery. Therefore, monitoring the load levels via the software while on battery will determine the actual load on the system during a power outage. Ensure the UPS is not loaded to more than 80% while on battery. Restore the utility by plugging the UPS back into the existing power source. Repeat this test when adding additional loads to make sure the UPS works properly.

## **Other Features:**

### **Overload Protection**

If an Overload situation is detected during the self-test, the UPS audible alarm will activate, emit a long beep, and automatically shut down the system. Unplug at least one piece of equipment from the Battery Supplied outlets. Switch the UPS OFF, wait 5 seconds, check to make sure the circuit breaker is reset, and then switch the UPS ON.

### **Self-Protection Failure**

The UPS is equipped with a self-protection feature to prevent damage to the UPS. Once the UPS is switched OFF, the user must wait 5 seconds before switching the UPS ON again.

### **Power Failure**

When a Power Failure occurs, after turning on the UPS, and prior to the self-test sequence, the UPS will automatically shut down and not restart until utility power is restored. Check to assure power is available at the receptacle being used for input power.

## **SOFTWARE AND COMPUTER INTERFACE**

### **Power Monitoring Software**

The UPSMON series software is used via a standard RS-232 interface to perform monitoring functions. It can provide an orderly shutdown of a computer in the event of a power failure. UPSMON displays diagnostic information on your monitor, including: Voltage, Frequency, Battery Level, etc. The software is available for DOS, Windows 3.1x, Windows 95/97/2000/ME/XP, Windows NT or later, Novell Netware, Linux and others. Call your dealer for more information on computer OS compatible solutions.

### **Interface Kits**

A series of interface kits are available to provide UPS monitoring. Each interface kit includes the special interface cable required to convert status signals from the UPS into signals which individual operating systems recognize. The interface cable must connect to the REMOTE PORT on the UPS, and to either COM 1 or COM 2 on the computer.

The communications port on the back of the UPS may be connected to a host computer. This port allows the computer to monitor the status of the UPS and control the operation of the UPS in some cases. Its major functions include some or all of the following:

- To broadcast a warning when power fails.
- To close any open files before the battery is exhausted.

- To turn-off the UPS.

Some computers are equipped with a special connector to link with the communication port. In addition, special cords may be required. Some computers may require special UPS monitoring software. Contact your dealer for the details on the various interface kits.

## BATTERIES

The life of batteries used in these UPS products is estimated at 3-6 years depending on level of usage. Once the battery is no longer useful and must be replaced, please contact service personnel for assistance.

### REPLACING THE BATTERY (QUALIFIED SERVICE PERSONNEL ONLY)

**CAUTION!** Read and follow the IMPORTANT SAFETY INSTRUCTIONS before servicing the battery. Service the battery under the supervision of Qualified Service Personnel knowledgeable of batteries and their precautions.

**CAUTION!** Use only the specified type of battery. See your dealer for replacement batteries.

**CAUTION!** The battery may present risk of electrical shock. Do not dispose of batteries in a fire as it may explode. Follow all local ordinances regarding proper disposal of batteries.

**CAUTION!** Do not open or mutilate the batteries. Released electrolyte is harmful to skin and eyes and may be toxic.

**CAUTION!** Although the battery system voltage is only 12VDC and 24VDC, the battery can present a high risk of short circuit current and electrical shock. The short circuit current capability of the battery is sufficient to burn wire or tools very rapidly, producing molten metal. Observe these precautions when replacing the battery:

1. Remove all watches, rings or other metal objects.
2. Only use tools with insulated handles.
3. Do not lay tools or metal parts on top of battery or any terminals.
4. Wear protective eye wear (goggles), rubber gloves and boots.
5. Power down the UPS and disconnect the charging source before removing covers.
6. Determine if the battery is inadvertently grounded. If inadvertently grounded, remove the source of the ground. Contact with a grounded battery can result in electrical shock! The likelihood of such shock will be reduced if such grounds are removed during installation and maintenance (applicable to a UPS and a remote battery supply not having a grounded circuit).
7. Disconnect the battery terminals to remove old batteries.
8. Measure the DC voltage of the approved replacement batteries for the proper value.
9. Install and connect new batteries ensuring proper polarity and voltage.
10. Replace cover(s), reconnect AC source, and restart the UPS.



## AUDIBLE ALARMS

Alarm Indication	Unit Status
SLOW BEEPING SOUND	ON BATTERY
RAPID BEEPING SOUND	LOW BATTERY
CONTINUOUS BEEPING SOUND	OVERLOAD

## TROUBLESHOOTING

The UPS has a self protect feature that prevents the UPS from being damaged as a result of overheating. If the temperature is higher than 55°C, the UPS will shut down. If this happens, wait for several minutes for the UPS to cool down, and then restart the UPS.

PROBLEM	POSSIBLE CAUSE	SOLUTION
Full-time Bypass outlets stop providing power to the equipment	Circuit breaker has tripped due to an overload	Turn the UPS off & unplug at least one piece of equipment. Wait 10 sec, reset the circuit breaker on the UPS & turn the UPS on
The UPS does not supply expected runtime	Battery not fully charged	Recharge the battery by leaving the UPS plugged in and switched on
	The power required by your equipment slightly exceeds the capacity of the UPS	Unplug at least one piece of equipment from the UPS outlets
	The battery is defective or worn out	Contact Xtreme Power Conversion about replacement of batteries
The UPS will not turn on	The on/off switch is designed to prevent damage by rapidly turning it off and on	Turn the UPS off. Wait 10 sec & then turn the UPS on
	The UPS is not plugged into an AC wall outlet	Connect the UPS to an 110/120V 60Hz AC wall outlet
	The battery is defective or worn out	Contact Xtreme Power Conversion about replacement of batteries
	Mechanical problem	Contact Xtreme Power Conversion
The UPS shuts down when there is loss of AC power	The UPS is not providing battery power	Shutdown your load & turn the UPS off. Wait 10 sec & turn the UPS back on. This should reset the UPS

## SPECIFICATIONS

	120V MODEL	XVRT-1000	XVRT-1500	XVRT-2200	XVRT-3000
INPUT	Voltage	120 ± 25% at line input			
	Capacity VA (W)	1000 VA (600 W)	1500 VA (900 W)	2000 VA (1320 W)	3000 VA (1800 W)
	Frequency	50/60 Hz ± 10% auto sensing			
	Topology	Line- Interactive			
OUTPUT	Voltage (on battery)	100 / 115 VAC ± 5%			
	Frequency (on battery)	50/60 Hz ± 0.5%			
	Transfer Time	2-4 ms (typical)			
	Voltage Regulation (AVR)	AVR automatically increases output voltage 15% above input voltage if -9% to -25% of nominal; AVR decreases output voltage 13% below input voltage if +9% to +25% of nominal			
PROTECTION & FILTERING	Spike Protection	320 Joules			
	EMI / RFI Filter	10dBA at 0.15MHz, 50dB at 30MHz			
	Overload Protection	UPS automatic shutdown if overload exceeds 110% of nominal at 60 seconds and 130% at 3 seconds			
	10Base-T Cable Port	Network (UTP, RJ-45) compatible jacks			
BATTERY	Battery Type	Sealed, Maintenance-Free lead acid			
	Battery Quantity & Size	(3) 6V 8AH	(2) 12V 9AH	(4) 12V 9AH	(4) 12V 9AH
	Typical Recharge Time	8 hours (to 90% of full capacity)			
PHYSICAL	Dimensions	W x D x H (inches)	W x D x H (inches)	W x D x H (inches)	W x D x H (inches)
		15.0"x 14.3"x 1.7"	16.9"x 14.0"x 3.3"	16.9"x 13.8"x 5.1"	16.9"x 19.1"x 5.1"
		1U	2U	3U	3U
	Unit Weight	25.3 lbs	35.9 lbs	62.6 lbs	71.9 lbs
	Shipping Dimensions	18.8"x 17.2"x 6.3"	23.0"x 21.0"x 8.7"	22.4"x 20.5"x 11.2"	26.1"x 23.0"x 11.2"
	Shipping Weight	28.6 lbs	42.5 lbs	68.5 lbs	79.4 lbs
	Line Cord (6 ft.)	5-15P	5-15P	5-15P	L5-30P
	Receptacles	(4) NEMA 5-15R + (1) NEMA 5-15R BYPASS	(6) NEMA 5-15R	(6) NEMA 5-15R	(1) NEMA L5-30R + (4) NEMA 5-15R
	Communication Interface	RS232 bi-directional communication port – also, (1) RS232 to USB cable is provided to allow for USB connection / communications			
	SNMP Connectivity	via external SNMP card			
ENVIRONMENT	Operating Temperature	0-35°C for Ambient Operation			
	Audible Noise	< 40dBA			
	Altitude	11500 ft (3500 m) above sea level			
WARRANTY	Warranty	Three Years Electronics / One Year Batteries			
APPROVALS	North America	UL cUL FCC			
INDICATORS & ALARMS	Battery Backup	Slow beeping sound			
	Battery Low	Rapid beeping sound			
	Overload	Continuous beeping sound			

## SHIPPING LIST

1. (1) UPS
2. (1) User's and Installation Manual
3. (1) power cord (for XVRT-1000 & XVRT-1500)
4. (1) 6 ft USB-DB9 adaptor cable
5. (1) UPSMON CD (monitoring software)
6. (1) phone cord (for use with telephone/data surge protection)
7. (1) set of vertical mounting brackets
8. (1) set of horizontal mounting brackets

## OBTAINING SERVICE

If the UPS requires Service:

1. Use the TROUBLESHOOTING section in this manual to eliminate obvious causes.
2. Verify there are no circuit breakers tripped.
3. Call your dealer for assistance. If you cannot reach your dealer, or if they cannot resolve the problem, call Xtreme Power Conversion Corp Technical Support at 800.582.4524. Technical support inquiries can also be made at [support@xpcc.com](mailto:support@xpcc.com). Please have the following information available BEFORE calling the Technical Support Department:
  - a. Your name and address.
  - b. The serial number of the unit.
  - c. Where and when the unit was purchased.
  - d. All of the model information about your UPS.
  - e. Any information on the failure, including LED's that may or may not be illuminated.
  - f. A description of the protected equipment, including model numbers if possible.

A technician will ask you for the above information and, if possible, help solve your problem over the phone. In the event that the unit requires factory service, the technician will issue you a Return Material Authorization number (RMA).

If you are returning the UPS to Xtreme Power for service, please follow these procedures:

1. Pack the UPS in its original packaging. If the original packaging is no longer available, as the Technical Support Technician about obtaining a replacement set of packaging material. It is important to pack the UPS properly in order to avoid damage in transit. Never use Styrofoam beads for a packing material.
2. Include a letter with your name, address, daytime phone number, RMA number, a copy of your original sales receipt, and a brief description of the problem.
3. Mark the RMA number on the outside of all packages. Xtreme Power cannot accept any package without the RMA number marked on the outside of the boxes.
4. Return the UPS by insured, prepaid carrier to the address provided by the Technician.

Refer to the Warranty statements in this manual for additional details on what is covered.

## **XTREME POWER CONVERSION™ (XPC) CORPORATION LIMITED WARRANTY**

Xtreme Power Conversion (XPC) Corporation warrants Xtreme Power Conversion equipment, when properly applied and operated within specified conditions, against faulty materials or workmanship (excluding batteries) for a period of **three years for XVRT-Series products** from the date of purchase. XPC Corporation warrants **internal batteries for a period of one year** from the date of purchase. For equipment sites within the United States and Canada, this warranty covers repair or replacement, at the sole discretion of XPC Corporation. The customer is responsible for the costs of shipping the defective product to XPC Corporation. XPC Corporation will pay for ground shipment of the repaired or replacement product. This warranty applies only to the original purchaser.

If equipment provided by XPC Corporation is found to be **Dead-on-Arrival (DOA)**, XPC Corporation will be responsible for the costs of shipping product to and returning equipment from the customer in a timely manner as agreed to with the customer, once the customer has requested and received a **Return Material Authorization (RMA)** number. DOA equipment is defined as equipment that does not properly function according to user documentation when initially received and connected in conjunction with proper procedures as shown in the user documentation or via support provided by XPC Corporation personnel or authorized agents.

This warranty shall be void if (a) the equipment is repaired or modified by anyone other than XPC Corporation or a XPC Corporation approved third party; (b) the equipment is damaged by the customer, is improperly used or stored, is subjected to an adverse operating environment, or is operated outside the limits of its electrical specifications; or (c) the equipment has been used or stored in a manner contrary to the equipment's operating manual, intended use or other written instructions. Any technical advice furnished by XPC Corporation or a XPC Corporation authorized representative before or after delivery with regard to the use or application of Xtreme Power Conversion equipment is furnished on the basis that it represents XPC Corporations best judgment under the situation and circumstances, but it is used at the recipient's sole risk.

EXCEPT AS STATED ABOVE, XPC Corporation DISCLAIMS ALL WARRANTIES, EXPRESSED OR IMPLIED, INCLUDING WARRANTIES OF MERCHANTABILITY AND FITNESS FOR A PARTICULAR PURPOSE.

EXCEPT AS STATED ABOVE, IN NO EVENT WILL XPC Corporation BE LIABLE FOR DIRECT, INDIRECT, SPECIAL, INCIDENTAL, OR CONSEQUENTIAL DAMAGES ARISING OUT OF THE USE OF Xtreme Power Conversion EQUIPMENT, including but not limited to, any costs, lost profits or revenue, loss of equipment, loss of use of equipment, loss of software, loss of data, cost of substitutes, or claims by third parties..Purchaser's sole and exclusive remedy for breach of any warranty, expressed or implied, concerning Xtreme Power Conversion equipment, and the only obligation of XPC Corporation under this warranty, shall be the repair or replacement of defective equipment, components, or parts; or, at XPC Corporations sole discretion, refund of the purchase price or substitution of an equivalent replacement product.

## APPENDIX A: SNMP CONFIGURATION GUIDE

- You must configure the Net Logic Card before it can operate properly.
- You have two methods to configure the Net Logic Card: Using telnet or terminal listed below to access the configuration screen.
- Once the SNMP card is configured and you have accessed the SNMP web page, you can view the user guide through the help section by clicking on the “?” link to further configure the SNMP card to site parameters.

**CAUTION:** A default setting of the SNMP card is to shutdown the UPS after 300 seconds when a utility power failure occurs. Changes to this setting can only be made through the web interface after the initial configuration with Telnet or Terminal is completed. To make changes to this setting:

1. Log into the web browser by typing the IP address in the browser's address bar.
2. Enter the username and password of *dnpower* for both fields.
3. Go to the configuration tab and select Event actions.
4. Highlight Power Failure and hit select.
5. Scroll down to Power Failure-Shutdown and uncheck “Enable”. This disables the feature
6. Leaving “Enable” checked and changing the delay time will shutdown the UPS when a power failure occurs after the specified delay time is reached.

### Using Telnet

1. Make sure the Net Logic Card is plugged in the UPS properly.
2. Connect a network cable to the LAN connector on the Net Logic Card.
3. Telnet to the Net Logic Card from the PC via the path described below:  
Start/run/telnet 192.168.1.254
4. Use *dnpower* for the User Name and for the Password.
5. A Configuration Screen is displayed.

Note: The default IP address of the Card is 192.168.1.254. The default login user name and password are both *dnpower*.

### Using Terminal

1. Make sure the Net Logic Card is plugged in the UPS properly.
2. Connect the modem cable to the MODEM connector on the Net Logic Card.
3. Connect a null modem cable to the end of the model cable.
4. Connect the other end of the null modem cable to a serial port on your computer.

.NETpower <---(MODEM cable)---> <---(null modem cable)---> Computer running  
Terminal program

5. Make sure the serial port is not used by any program on your PC.
6. Run a terminal program, such as HyperTerminal.
7. Configure the serial port for 9600 bps, no parity, 8 data bits, 1 stop bit, and no flow control.
8. Reboot the Net Logic Card.
9. Press ESC key right after reboot. The Card/Box will detect if the user presses a ESC key for 5 seconds. If so, it will allow the user to log in; otherwise, it will try to initialize the external MODEM for other usages. So you have to press the ESC key as quickly as possible. You may keep holding the ESC without releasing it right after the system is started to make sure it will not be too late or missing.
10. Use dnpower for the User Name and for the Password.
11. A Configuration Screen is displayed.

Note: The default login user name and password are both dnpower.

## Configuration Screen

When you enter into the Configuration Screen, the following menu is displayed:

```
.NETpower SNMP agent adapter Configuration
#####
<# Main Menu #>
#####
1) SNMP Agent IP Parameter
2) MIB-II System Group
3) SNMP read/write Access Control
4) SNMP Trap Receivers
5) UPS Properties
6) System Time & Time Server
7) User Account
8) E-mail Setting
9) Environmental Monitoring Module
w) Web and Telnet Service Setting
u) Upgrade firmware
r) Restore Default Configuration Data
b) Reboot SNMP agent adapter
s) Save & Reboot
```

Exit Without Saving

Enter Choice >>

## SNMP Agent IP Parameter

To configure the SNMP agent IP parameters, enter a 1 at the main menu. The following screen will appear allowing you to configure IP address, Subnet Mask and Gateway.

.NETpower SNMP agent adapter Configuration

IP Parameter Setup

My IP Address: 192.168.1.254

Subnet Mask: 255.255.255.0

Router/Gateway IP Address: 192.168.1.1

- 1) Set IP Address
  - 2) Set Subnet Mask
  - 3) Set Router/Gateway IP Address
- <0> Return to previous menu

Enter Choice >>

## MIB-II System Group

Enter a 2 at the main menu, the following screen will be displayed allowing you to configure some important MIB-II System Group items, including system name, contact person and system location.

.NETpower SNMP agent adapter Configuration

MIB-II System Group Setup Menu

Current values for the following MIB-II OID:

sysName: NETpower

sysContact: admin

sysLocation:

- 1) Set sysName
- 2) Set sysContact
- 3) Set sysLocation

<0> Return to previous menu



Enter Choice >>

## SNMP Read/Write Access Control

Enter a 3 at the main menu, the following screen will be displayed allowing you to setup the SNMP Access Control. Enter the community number (from 1 to 4) to specify a community string, an IP address, and the access privilege.

```
.NETpower SNMP agent adapter Configuration
SNMP Access Control Setup Menu
Community name IP address Access
#1
#2
#3
#4
1) Set Access Control #1
2) Set Access Control #2
3) Set Access Control #3
4) Set Access Control #4
<0> Return to previous menu
Enter Choice >>
```

## SNMP Trap Receivers

Enter a 4 at the main menu, the following screen will be displayed allowing you to setup the SNMP Trap Receivers. The Severity includes Any, Server, Warning and Informational. The Any means any event will be sent to the trap receiver. The Severe means only severe events will be sent to the trap receiver. The Warning means only warning events will be sent to the trap receiver. The Informational means only informational events will be sent to the trap receiver. The Generation item is used to enable or disable trap generation.

```
.NETpower SNMP agent adapter Configuration
SNMP Trap Receiver Setup Menu
IP address Community Severity Generation
#1
#2 192.168.1.2 public any disable
#3
#4
1) Set trap receiver #1
2) Set trap receiver #2
3) Set trap receiver #3
```

```
4) Set trap receiver #4
<0> Return to previous menu
Enter Choice >>
```

## UPS Properties

Enter a 5 at the main menu; the following screen will be displayed allowing you to setup the UPS Properties, including UPS Identification Name, UPS Attached Device and Last Battery Replacement Date.

```
.NETpower SNMP agent adapter Configuration
UPS Properties Setup
UPS Identification Name: UPS
UPS Attached Device: NA
Last Battery Replacement Date: 12/31/1969
1) Set UPS Identification Name
2) Set UPS Attached Device
3) Set Last Battery Replacement Date
<0> Return to previous menu
Enter Choice >>
```

## System Time & Time Server

Enter a 6 at the main menu, the following screen will be displayed allowing you to setup System Time. In this option, you can setup the date and time for the Net Logic Card. The SNTP Server and Time Zone settings are used for time adjustment. Specify the SNTP Server and Time Zone, and then choose 4 Adjust System Time to adjust your system time. If the values retrieved from the Internet are not what you want, you can still change the date and time manually .

```
.NETpower SNMP agent adapter Configuration
System Time & Time Server Setup
System Time: 01/07/2003 11:08:37
Time Server IP Address: 200.49.40.1
Time Zone: 0+
1) Set System Time
2) Set Time Server IP Address
3) Time Zone
4) Adjust System Time
<0> Return to previous menu
Enter Choice >>
```

## User Account

Enter a 7 at the main menu, the following screen will be displayed allowing you to setup user accounts those who can login to the Net Logic Card.

```
.NETpower SNMP agent adapter Configuration
User Account Setup Menu
User name Password
#1 dnpower *****
#2 *****
#3 *****
#4 *****
1) Set User Account #1
2) Set User Account #2
3) Set User Account #3
4) Set User Account #4
<0> Return to previous menu
Enter Choice >>
```

## E-mail Setting

Enter an 8 at the main menu; the following screen will be displayed allowing you to setup SMTP server. You have to setup it correctly so that the .NETpower device can send out mails when an event occurs.

```
.NETpower SNMP agent adapter Configuration
Email Parameter Setup
SMTP Server IP Address:
1) Set SMTP IP Address
<0> Return to previous menu
Enter Choice >>
```

## Environmental Monitoring Module

Enter a 9 at the main menu to setup the Environmental Monitoring Module. You have to install Environmental Monitoring Module before setup.

## Web and Telnet Service Setting

Enter w at the main menu to enable/disable Web/Telnet service. Enable Web Service when you want to monitor the UPS via a web browser. Enable or disable Telnet Service to specify whether it allows users to login via telnet.

```
.NETpower SNMP agent adapter Configuration
Web and Telnet Service Setup Menu
```

```

Web Service: disable
Telnet Service: enable
1) enable Web Service
2) disable Telnet Service
<0> Return to previous menu
Enter Choice >>
    
```

## Upgrade Firmware

Enter u at the main menu to upgrade firmware.

```

.NETpower SNMP agent adapter Configuration
Upgrade firmware
=====
1) Upgrade firmware from tftp server
2) Upgrade firmware from http server
<0> Return to previous menu
Enter Choice >>
    
```

When you choose 1, the following screen is displayed asking you to input the tftp server and the filename of the latest firmware. To make it work, you must have a tftp server installed and copy the firmware file to the tftp server.

```

Input the tftp server address >> 192.168.1.1
Input the file name >> dnpower.bin
    
```

When you choose 2, the following screen is displayed asking you to input the url pointed to the firmware file. To make it work, you must have a web server installed and copy the firmware file to the web server.

```

Input the URL (Example: http://192.168.1.1/dnpower.bin) >>
http://192.168.1.1/dnpower.bin
    
```

## Restore Default Configuration Data

To reset the configuration data, enter r at the main menu. When the next menu is displayed, choose 1 to reset all values to their factory default settings, or choose 0 to return to the previous menu without resetting the data.

```

.NETpower SNMP agent adapter Configuration
Restore default data
=====
1) Yes, Do it
    
```

```
<0> Return to previous menu
Enter Choice >>
```

## Reboot SNMP Agent Adapter

Enter b at the main menu to reboot the .NETpower device. All settings will not be saved. When the next menu is displayed, choose 1 to reboot the .NETpower device, or choose 0 to return to the previous menu.

```
.NETpower SNMP agent adapter Configuration
Reboot
=====
1) Yes, Do it
<0> Return to previous menu
Enter Choice >>
```

## Save & Reboot

To save configuration data and reboot, enter s at the main menu. When the next menu is displayed, choose 1 to save configuration data and reboot the .NETpower device, or choose 0 to return to the previous menu.

```
.NETpower SNMP agent adapter Configuration
Save & Exit
=====
1) Yes, Do it
<0> Return to previous menu
Enter Choice >>
```

## Exit Without Saving

Enter x at the main menu to exit the Configuration Screen