



EurotestEASI
MI 3100 SE
Short instructions
Version 1.1, Code no. 20 752 164

Distributor:

Manufacturer:

METREL d.d.
Ljubljanska cesta 77
1354 Horjul
Slovenia
web site: <http://www.metrel.si>
e-mail: metrel@metrel.si



Mark on your equipment certifies that this equipment meets the requirements of the EU (European Union) concerning safety and electromagnetic compatibility regulations

© 2013 METREL

The trade names Metrel, Smartec, Eurotest, Autosequence are trademarks registered or pending in Europe and other countries.

No part of this publication may be reproduced or utilized in any form or by any means without permission in writing from METREL.

Table of Contents

1	Start-up guide.....	4
1.1	Safety and operational considerations	4
1.2	Instrument description – Front and connector panel	6
1.3	Instrument description – Meaning of symbols	8
1.4	Selecting operating mode / measuring functions	9
1.5	Battery handling.....	10
1.6	Maintenance	11
1.6.1	Replacing fuses	11
1.7	Warranty & Repairs	12
2	Quick-test guide	13
2.1	Null the leads.....	13
2.2	Measurements.....	14
2.2.1	Voltage, frequency and phase sequence	14
2.2.2	Insulation resistance.....	15
2.2.3	Resistance of earth connection and equipotential bonding.....	16
2.2.4	Ring continuity (only with EASI switch A 1214).....	19
2.2.5	Testing RCDs	21
2.2.6	Fault loop impedance	23
2.2.7	Line impedance	24
2.2.8	PE conductor resistance.....	26
2.2.9	Earth resistance.....	27
2.3	Auto-sequences.....	28

1 Start-up guide

1.1 Safety and operational considerations



Warnings related to safety – general information

- ❑ This document is not a supplement to the Instruction manual!
- ❑ The  symbol on the instrument means »Read the Instruction manual with special care for safe operation«. The symbol requires an action!
- ❑ If the test equipment is used in a manner not specified in this user manual, the protection provided by the equipment could be impaired!
- ❑ Read this user manual carefully, otherwise the use of the instrument may be dangerous for the operator, the instrument or for the equipment under test!
- ❑ Do not use the instrument or any of the accessories if any damage is noticed!
- ❑ Consider all generally known precautions in order to avoid risk of electric shock while dealing with hazardous voltages!
- ❑ In case a fuse has blown follow the instructions in this manual in order to replace it! Use only fuses that are specified!
- ❑ Do not use the instrument in AC supply systems with voltages higher than 550 V a.c.
- ❑ Service, repairs or adjustment of instruments and accessories is only allowed to be carried out by a competent authorized personnel!
- ❑ Use only standard or optional test accessories supplied by your distributor!
- ❑ Consider that protection category of some accessories is lower than of the instrument. Test tips and Tip commander have removable caps. If they are removed the protection falls to CAT II. Check markings on accessories!
 - cap off, 18 mm tip: CAT II up to 1000 V
 - cap on, 4 mm tip: CAT II 1000 V / CAT III 600 V / CAT IV 300 V
- ❑ The instrument comes supplied with rechargeable Ni-MH battery cells. The cells should only be replaced with the same type as defined on the battery compartment label or as described in this manual. Do not use standard alkaline battery cells while the power supply adapter is connected, otherwise they may explode!
- ❑ Hazardous voltages exist inside the instrument. Disconnect all test leads, remove the power supply cable and switch off the instrument before removing battery compartment cover.
- ❑ All normal safety precautions must be taken in order to avoid risk of electric shock while working on electrical installations!



Warnings related to safety – measurements

Insulation resistance

- ❑ Insulation resistance measurement should only be performed on de-energized objects!
- ❑ Do not touch the test object during the measurement or before it is fully discharged! Risk of electric shock!
- ❑ When an insulation resistance measurement has been performed on a capacitive object, automatic discharge may not be done immediately! The warning message  and the actual voltage are displayed during discharge until voltage drops below 30 V.
- ❑ Do not connect test terminals to external voltage higher than 600 V (AC or DC) in order not to damage the test instrument!

Continuity functions

- ❑ Continuity measurements should only be performed on de-energized objects!
- ❑ Parallel loops may influence on test results.

Testing PE terminal

- ❑ If phase voltage is detected on the tested PE terminal, stop all measurements immediately and ensure the cause of the fault is eliminated before proceeding with any activity!



Warnings related to safety – batteries

- ❑ When connected to an installation, the instruments battery compartment can contain hazardous voltage inside! When replacing battery cells or before opening the battery/fuse compartment cover, disconnect any measuring accessory connected to the instrument and turn off the instrument.
- ❑ Ensure that the battery cells are inserted correctly otherwise the instrument will not operate and the batteries could be discharged.
- ❑ Do not recharge alkaline battery cells!
- ❑ Use only power supply adapter delivered from the manufacturer or distributor of the test equipment!



Warnings related to safety –commanders

Measuring category of commanders:

Tip commander A 1401 (cap off, 18 mm tip)..... 1000 V CAT II / 600 V CAT II / 300 V CAT II

Tip commander A 1401 (cap on, 4 mm tip)..... 1000 V CAT II / 600 V CAT III / 300 V CAT IV

- ❑ Measuring category of commanders can be lower than protection category of the instrument.
- ❑ If dangerous voltage is detected on the tested PE terminal, immediately stop all measurements, find and remove the fault!
- ❑ When replacing battery cells or before opening the battery compartment cover, disconnect the measuring accessory from the instrument and installation.

1.2 Instrument description – Front and connector panel

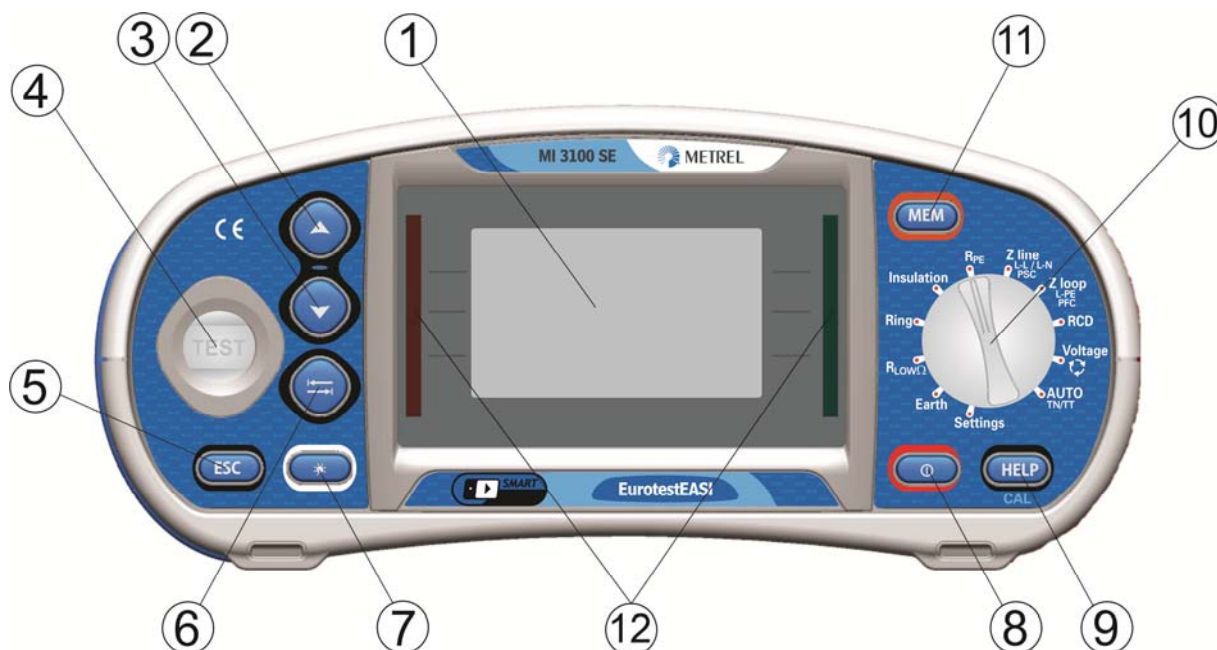

Legend:

1	LCD	128 x 64 dots matrix display with backlight.
2	UP	Modifies selected parameter.
3	DOWN	
4	TEST	TEST Starts measurements. Acts also as the PE touching electrode.
5	ESC	Goes one level back.
6	TAB	Selects the parameters in selected function.
7	Backlight, Contrast	Changes backlight level and contrast.
8	ON / OFF	Switches the instrument power on or off. The instrument automatically turns off 15 minutes after the last key was pressed.
9	HELP / CAL	Accesses help menus. Calibrates test leads in Continuity functions. Starts Z_{REF} measurement in Voltage drop sub-function.
10	Function selector switch	Selects test / measurement function and settings.
11	MEM	Stores / recalls memory of instrument.
12	Green LEDs Red LEDs	Indicates PASS / FAIL of result.

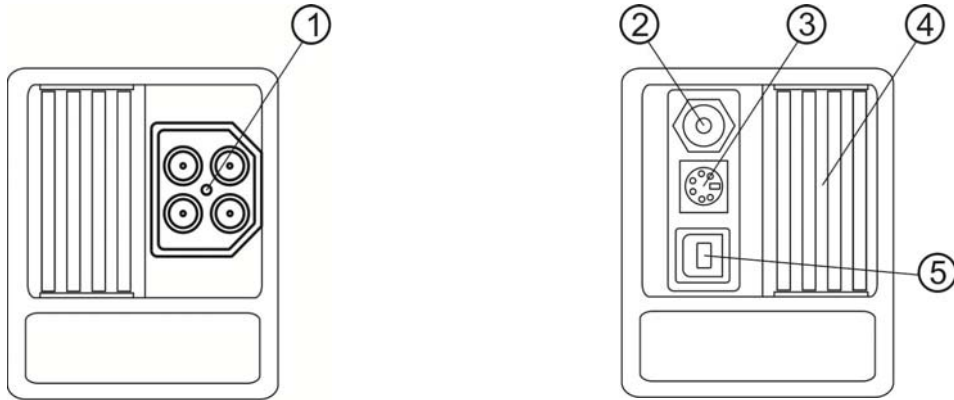





Legend:

1	Test connector	Measuring inputs / outputs.
2	Charger socket	
3	PS/2 connector	Communication with PC serial port Connection to barcode / RFID reader Connection of Bluetooth dongle
4	Protection cover	
5	USB connector	Communication with PC USB (1.1) port.

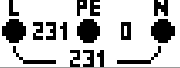

1.3 Instrument description – Meaning of symbols

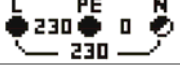
Terminal voltage monitor











The terminal voltage monitor displays on-line the voltages on the test terminals and information about active test terminals in the a.c. installation measuring mode.





	Online voltages are displayed together with test terminal indication. All three test terminals are used for selected measurement.
	Online voltages are displayed together with test terminal indication. L and N test terminals are used for selected measurement.
	L and PE are active test terminals; N terminal should also be connected for correct input voltage condition.
	Polarity of test voltage applied to the output terminals, L and N.

Battery indication

	Battery capacity indication.
	Low battery. Battery is too weak to guarantee correct result. Replace or recharge the battery cells.
	Charging in progress (if power supply adapter is connected).

Messages



	Measurement is running, consider displayed warnings.
	Conditions on the input terminals allow starting the measurement; consider other displayed warnings and messages.
	Conditions on the input terminals do not allow starting the measurement, consider displayed warnings and messages.
	RCD tripped-out during the measurement (in RCD functions).
	Portable RCD selected (PRCD).
	Instrument is overheated. The measurement is prohibited until the temperature decreases under the allowed limit.
	Result(s) can be stored.
	High electrical noise was detected during measurement. Results may be impaired.
	L and N are changed.
	Warning! High voltage is applied to the test terminals.
	Warning! Dangerous voltage on the PE terminal! Stop the activity immediately and eliminate the fault / connection problem before proceeding with any activity!

	Test leads resistance in Continuity measurement is not compensated.
	Test leads resistance in Continuity measurement is compensated.
	High resistance to earth of test probes. Results may be impaired.
	Measured signal is out of range (clipped). Results are impaired.
	Fuse F1 is broken.





Sound warnings

Continuous sound **Warning!** Dangerous voltage on the PE terminal is detected.

Results

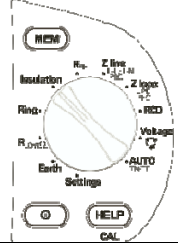
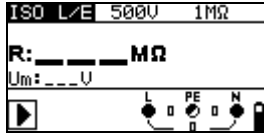
	Measurement result is inside pre-set limits (PASS).
	Measurement result is out of pre-set limits (FAIL).
	Measurement is aborted. Consider displayed warnings and messages.

1.4 Selecting operating mode / measuring functions

	Selects measuring function, settings menu and autotest mode.	
	Selects sub-function Selects value of parameter / limit	
	Selects parameter / limits	
	Starts measurement	

1.5 Battery handling

- ❑ Consider warnings related to safety!
- ❑ Ensure that the battery cells are inserted correctly otherwise the instrument will not operate and the batteries could be discharged.
- ❑ If the instrument is not used for a long period of time, remove all of the battery from the battery compartment to protect the instrument from leakage.
- ❑ Alkaline or rechargeable Ni-MH battery cells (size AA) can be used. Do not recharge alkaline battery cells!

The battery will begin charging as soon as the power supply adapter is connected to the instrument. The in-built protection circuits control the charging procedure.



Power supply socket polarity

1.6 Maintenance

1.6.1 Replacing fuses

There are three fuses under back cover of the Eurotest instrument.

- **F1**
M 0.315 A / 250 V, 20×5 mm
This fuse protects internal circuitry for continuity functions if test probes are connected to the mains supply voltage by mistake during measurement.
- **F2, F3**
F 4 A / 500 V, 32×6.3 mm (breaking capacity: 50 kA)
General input protection fuses of test terminals L/L1 and N/L2.

Warnings:

- Disconnect any test leads / accessories from the instrument and installation and switch off the instrument before opening battery / fuse compartment cover. Hazardous voltage can exist inside the instrument!
- Replace any blown fuses with exactly the same type of fuse. Inserting the wrong fuse into the instrument can impair the operator's safety and / or damage the instrument.
- In case a fuse has blown in the instrument, follow the instructions in instruction manual to replace it!

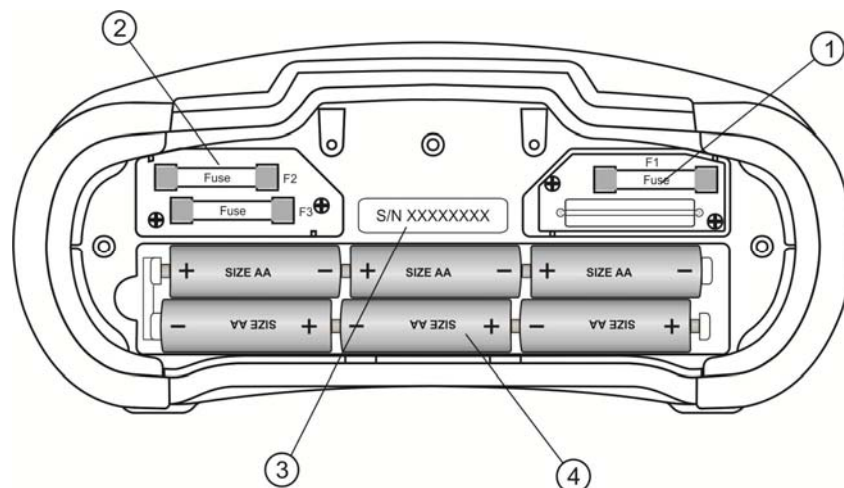

Legend:

1	Fuse F1	M 315 mA / 250 V
2	Fuses F2 and F3	F 4 A / 500 V (breaking capacity 50 kA)
3	Serial number label	
4	Battery cells	Size AA, alkaline / rechargeable NiMH

1.7 Warranty & Repairs

Metrel UK's instruments have a two years warranty against defects in materials or workmanship. Accessories and other supplementary products have a one year warranty against defects in material or workmanship.

Any potentially defective items should be returned to Metrel accompanied by information regarding the faults that was incurred. It is recommended that any defective equipment is sent back to Metrel via the wholesaler from which the product was purchased.

All defective products will be replaced or repaired within policy period. For these items, a full refund will only be issued if a sufficient replacement is not available. Any shipping / return-shipping costs are not refundable.

Metrel UK shall not be held liable for any loss or damage resulting from the use or performance of the products. In no event shall Metrel UK be liable to the customer or its customers for any special, indirect, incidental, exemplary or punitive damages resulting from loss of use, interruption of business or loss of profits, even if Metrel UK has been advised of the possibility of such damages.

If the customer's unit is out of warranty but needs repairs a quote for repair will be provided via the wholesaler through which the instrument was sent in.

Notes:

- ❑ Any unauthorized repair or calibration of the instrument will infringe the product's warranty.
- ❑ All sales are subject to Metrel UK's Standard Terms and Conditions, a full copy of which is available Metrel UK's office. Metrel UK reserves the right to change the conditions at any time. Any typographical, clerical or other error or omission in any sales literature, quotation, price list, acceptance of offer, invoice or other documentation or information issued by Metrel UK shall be subject to correction without any liability on the part of the customer.
- ❑ Specifications and designs of goods are subject to change by Metrel UK at any time without notice to the customer. Metrel UK reserves the right to make any changes in the specification of goods which are required to conform with any applicable statutory or EC requirements or, where goods are to be supplied to Metrel UK's specification, which do not materially affect their quality or performance.
- ❑ If a condition was found to be invalid or void it would not affect the overall validity of the remainder of the conditions;
- ❑ Metrel UK are excluded from liability for any delays or failure to comply, where the reason is beyond Metrel UK's control;
- ❑ No order which has been accepted by Metrel UK may be cancelled by the customer except with the agreement in writing of Metrel UK and on terms that the customer shall indemnify Metrel UK in full against all loss (including loss of profit), costs (including the cost of all labour and materials used), damages, charges and expenses incurred by Metrel UK as a result of cancellation. The minimum charge for such cancellation will be 25 % of the total value of the goods ordered.

2 Quick-test guide

2.1 Null the leads

1. Set function.



R_{LOW}Ω

Ring



R_{LOW}Ω
CONTINUITY
 r1
 rN
 r2
 R1+R2
 R2
 R1+RN

RING r1, r2, rN
 RING R1+RN, R1+R2

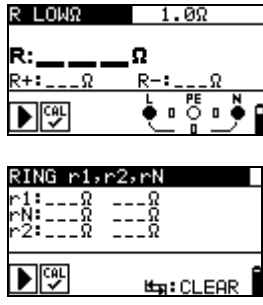

2. Compensating the resistance of test leads scheme

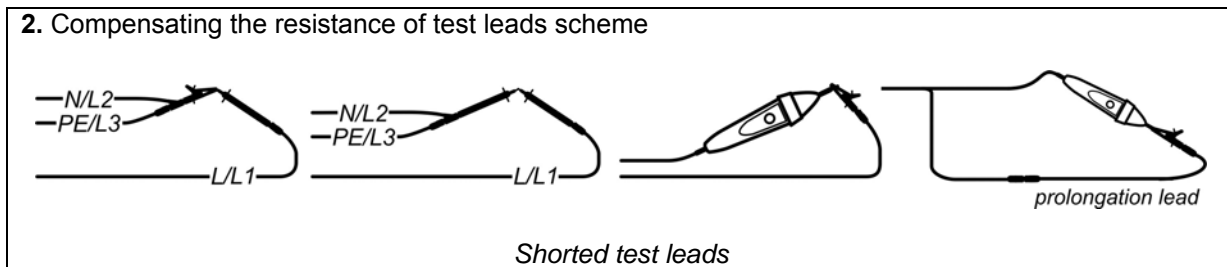

3. Press the  key.

4. Press the **CAL** key.

After performing test leads compensation first measured value and then 0.00 Ω is displayed.

If calibration was carried out successfully leads indicator  is shown in the continuity functions.

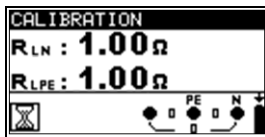

Measured value to be calibrated.

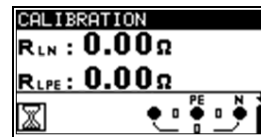

Reading at calibrated value is 0.00 Ω now.

2.2 Measurements

2.2.1 Voltage, frequency and phase sequence

1. Set function.



2. Connection diagrams

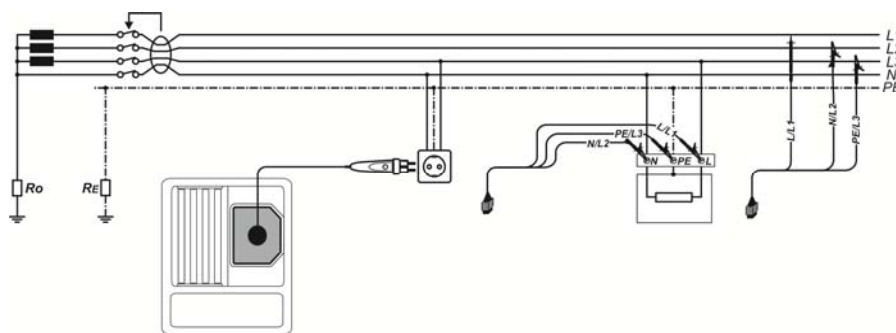

Connection of plug test cable and 3-wire test lead in single-phase system

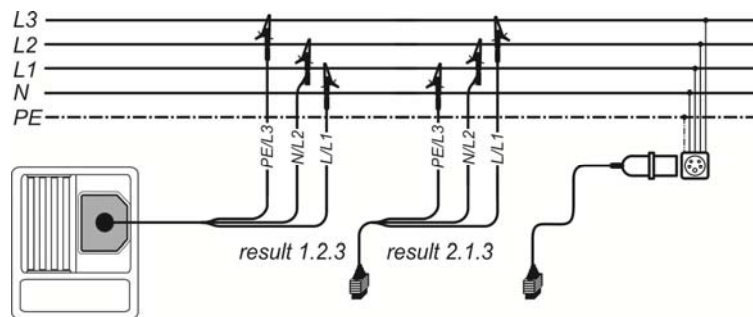

Connection of 3-wire test lead and optional adapter in three-phase system

3. View results and press the **MEM** key to save them.

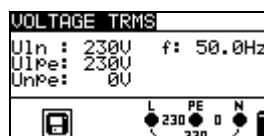

UIn Voltage between phase and neutral conductors
UIpe ... Voltage between phase and protective conductors
Unpe .. Voltage between neutral and protective conductors
f..... Frequency

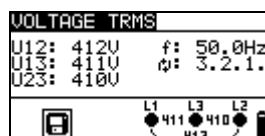

U12.... Voltage between phases L1 and L2
U13.... Voltage between phases L1 and L3
U23.... Voltage between phases L2 and L3
1.2.3 .. Correct connection – CW rotation sequence
3.2.1 .. Invalid connection – CCW rotation sequence
f..... Frequency

2.2.2 Insulation resistance

1. Set function.

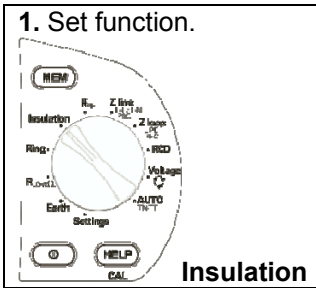

2. Set sub-function, parameters and limits



Insulation sub-function
 [ISO L/E, ISO L/N, ISO L/L, ISO N/E]
Nominal test voltage [50 V, 100 V, 250 V, 500 V, 1000 V]
Minimum insulation resistance
 [OFF, 0.01 MΩ ÷ 200 MΩ]

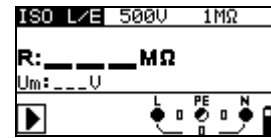

3. Connection diagrams

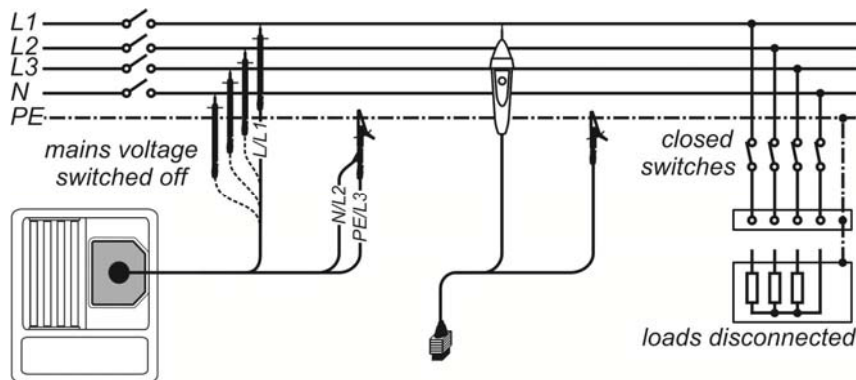

Connection of 3-wire test lead and tip commander

4. Press and hold the  key until result is stabilized.

5. View results and press the **MEM** key to save them.

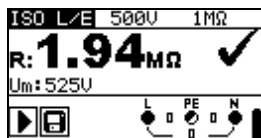

R Insulation resistance
Um Test voltage (actual value)

2.2.3 Resistance of earth connection and equipotential bonding

1. Set function.

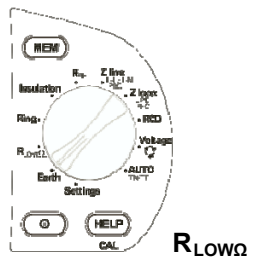

2. Set sub-function and limit



Resistance measurement sub-function
 [R LOW Ω , CONTINUITY, r1, rN, r2, R1+R2, R2, R1+RN]
Maximum resistance
 [OFF, 0.1 Ω ÷ 20.0 Ω]
Buzzer (CONTINUITY sub-function only)
 [ON, OFF]

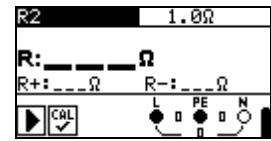

3. Connection diagrams

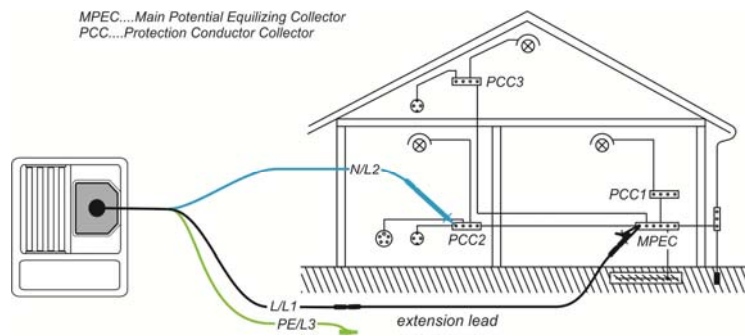

Connection of 3-wire test lead plus optional extension lead

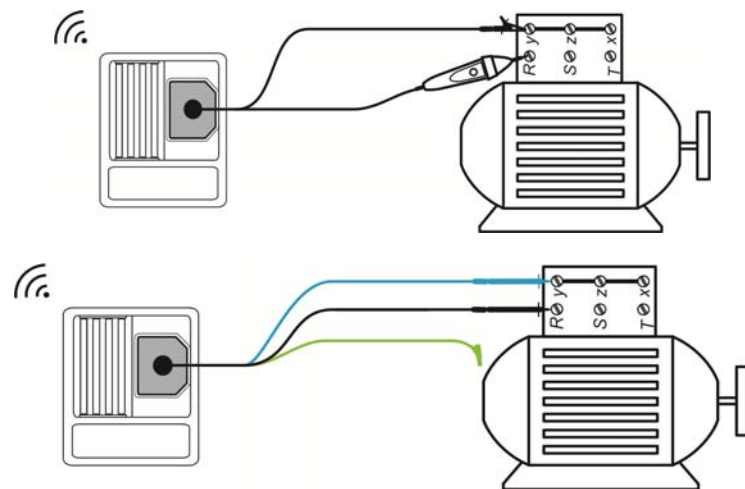

Tip commander and 3-wire test lead applications

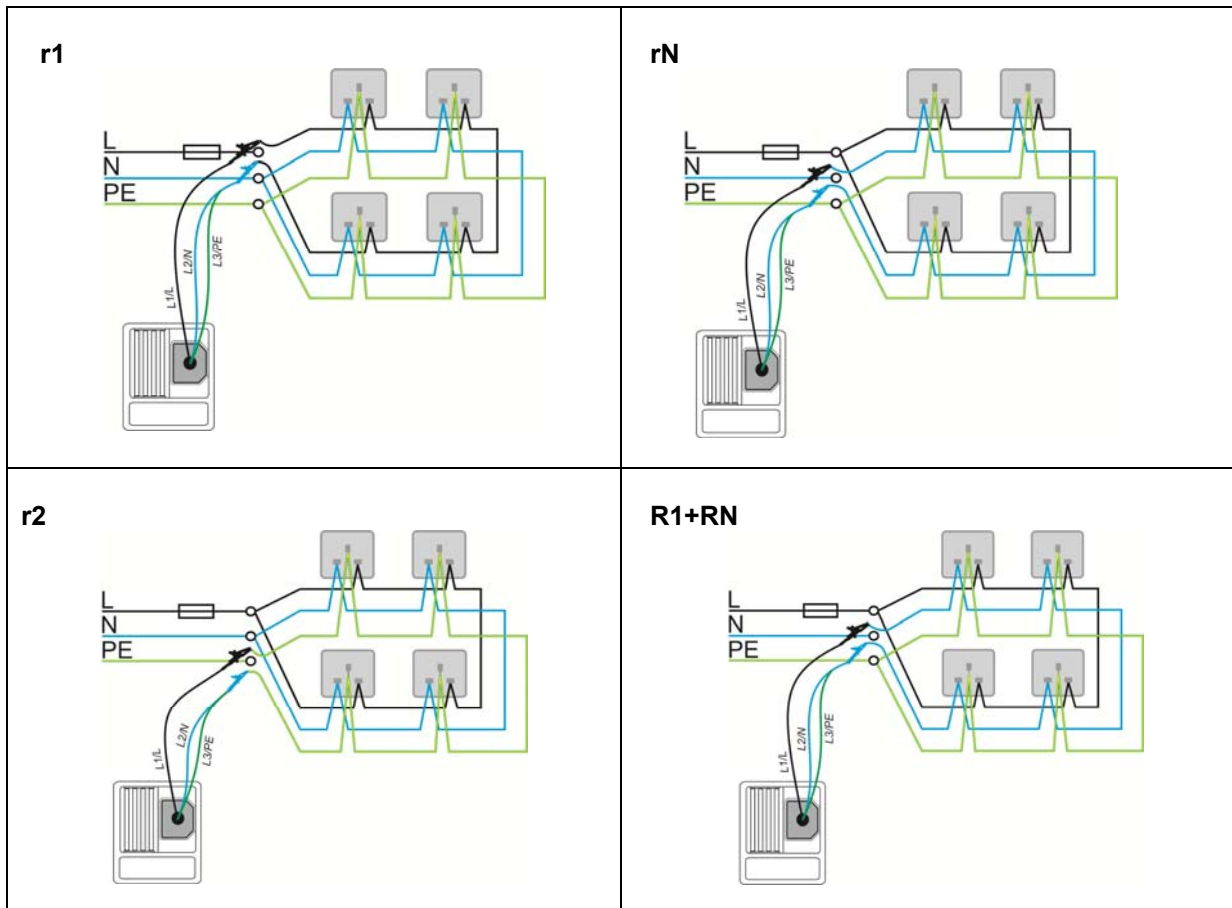

Connections for testing the r1, rN, r2 and R1+RN sections of the wiring in ring circuits

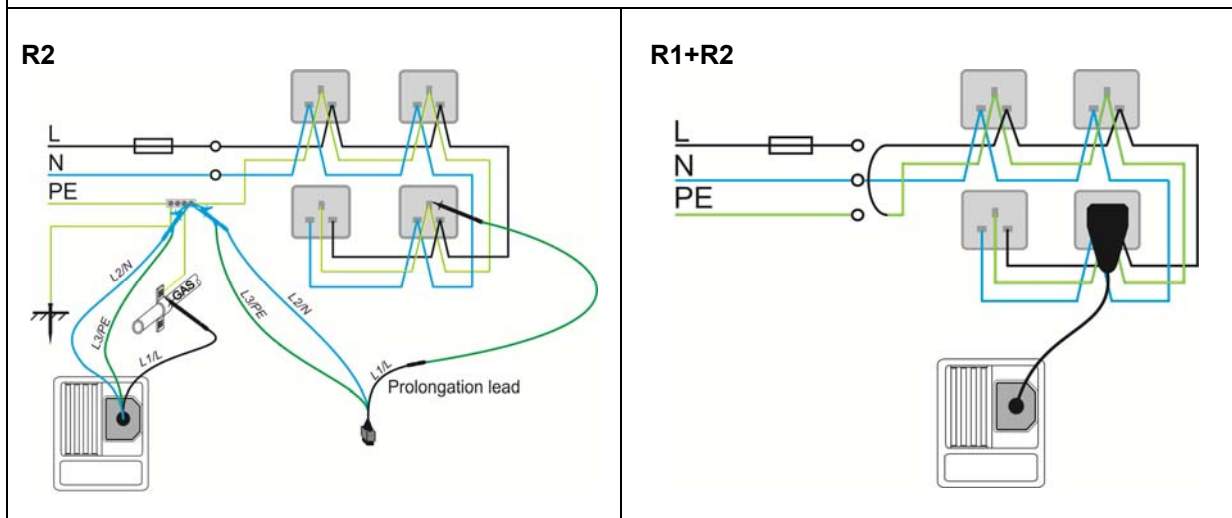

Connections for testing the R2 and R1+R2 sections of the wiring in final circuits

4.a R LOW Ω , r1, rN, r2, R1+R2, R2, R1+RN
sub-function:

Press the  key.

4.b CONTINUITY sub-function:

Press the  key to begin performing a continuous measurement.
Press the TEST key again to stop measurement

5. View results and press the **MEM** key to save them.

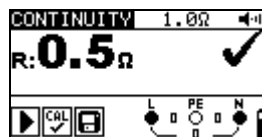
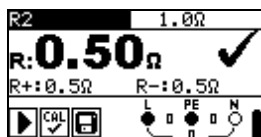



R R2 resistance

R+ Result at positive polarity



R-..... Result at negative test polarity

R.....CONTINUITY resistance

4. Step 1 – RING r1, r2, rN sub-function:

Press the  key for measurement.
 Commit results to r1, r2, rN with  key.
 (Before measurement, results can be cleared with  key.)

Step 2 – RING R1+RN, R1+R2 sub-function:

Press the  key for measurement.
 Commit results to R1+RN, R1+R2 with  key.
 (Before measurement, results can be cleared with  key.)
 Repeat measurement on other socket outlets and connection points in the final ring circuit. (Maximal results are to be considered.)

5. View results and press the MEM key to save them.

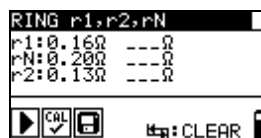
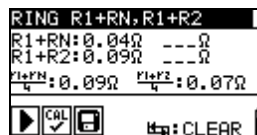
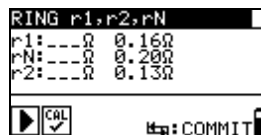

r1 ring resistance of line conductors
rN ring resistance of neutral conductors
r2 ring resistance of protective conductors

R1+RN reference test value, committed and measured
R1+R2 reference test value, committed and measured
(r1+r2)/4 calculated reference value
(r1+rN)/4 calculated reference value

2.2.5 Testing RCDs

1. Set function.

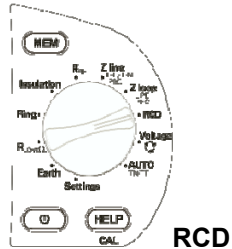

2. Set sub-function, parameters and limits



RCD test sub-functions

[Contact voltage U_c , Tripping time RCDt, Tripping current RCD I, RCD autotest]

Rated RCD residual current

sensitivity $I_{\Delta N}$ [10 mA, 30 mA, 100 mA, 300 mA, 500 mA, 1000 mA]

RCD type [AC, A, F]

Starting polarity [\sim , \wedge , \vee , ∇].

Characteristic and PRCD selection

[selective , general non-delayed , PRCD, PRCD-K, PRCD-S].

Multiplication factor for test current

[$\frac{1}{2}$, 1, 2, 5 $I_{\Delta N}$]

Conventional touchvoltage limit [25 V, 50 V].

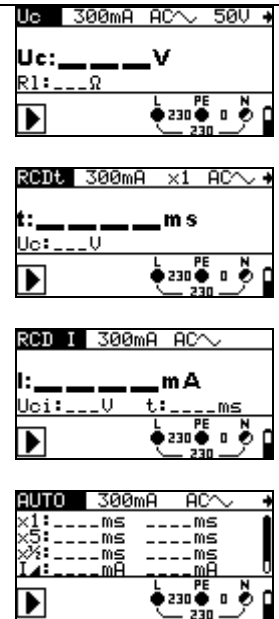

3. Connection diagram

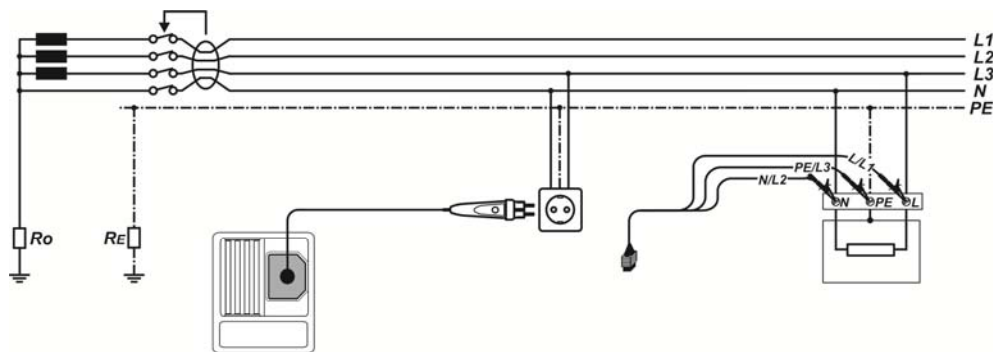

Connecting the plug test cable and the 3-wire test lead

4. Press the  key.

5. View results (press **HELP** key if multiple screens) and press the **MEM** key to save them.

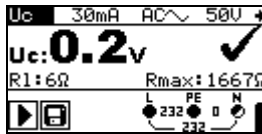

Uc Contact voltage
RI Fault loop resistance
RmaxMax. earth fault loop resistance

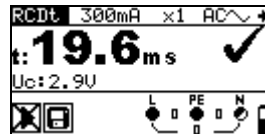

t Trip-out time
Uc Contact voltage for rated $I_{\Delta N}$

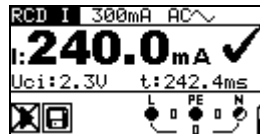

I Trip-out current
Uci Contact voltage at trip-out current I or end value in case the RCD didn't trip
t Trip-out time

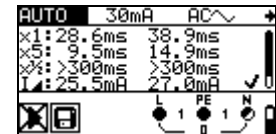

x1 Step 1 trip-out time ($I_{\Delta} = I_{\Delta N}, 0^{\circ}$)
x1 Step 2 trip-out time ($I_{\Delta} = I_{\Delta N}, 180^{\circ}$)
x5 Step 3 trip-out time ($I_{\Delta} = 5 \times I_{\Delta N}, 0^{\circ}$)
x5 Step 4 trip-out time ($I_{\Delta} = 5 \times I_{\Delta N}, 180^{\circ}$)
x1/2 Step 5 trip-out time ($I_{\Delta} = 1/2 \times I_{\Delta N}, 0^{\circ}$)
x1/2 Step 6 trip-out time ($I_{\Delta} = 1/2 \times I_{\Delta N}, 180^{\circ}$)
L Step 7 trip-out current (0°)
L Step 8 trip-out current (180°)
Uc ... Contact voltage for rated $I_{\Delta N}$

2.2.7 Line impedance

1. Set function.

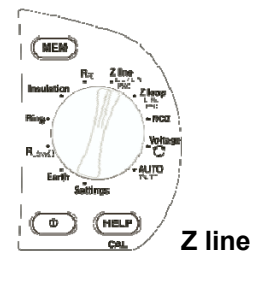

2. Set sub-function, parameters and limits

Selection of line impedance [Zline] or voltage drop [ΔU] sub-function
Fuse type [---, BS88-2, BS3036, BS88-3, BS1362, B, C, D]
Rated current of selected fuse
Maximum breaking time of selected fuse
High limit line impedance value for selected fuse
Maximum voltage drop [3.0 % ÷ 9.0 %]

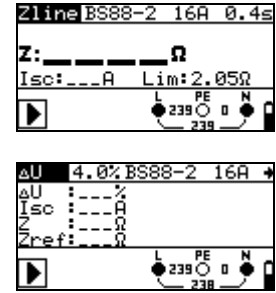

3. Connection diagrams
Line impedance

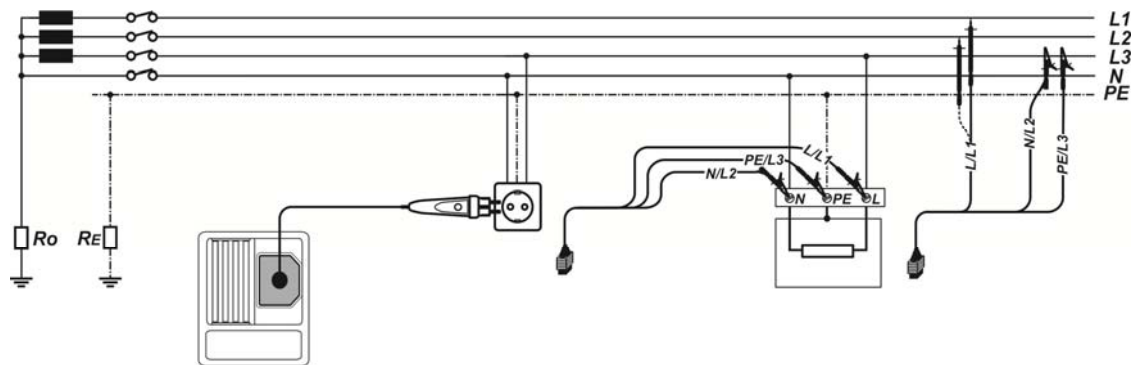

Phase-neutral or phase-phase line impedance measurement – connection of the plug test cable and the 3-wire test lead

Circuits for measurement of voltage drop

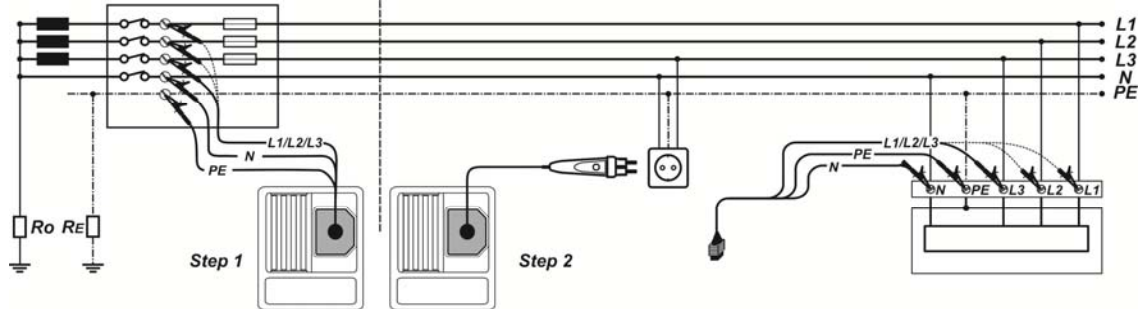

Phase-neutral or phase-phase voltage drop measurement – connection of the plug test cable and 3-wire test lead

4. Press the  key.

5. View results and press the **MEM** key to save them.



Z..... Line impedance
Isc..... Prospective short-circuit current
Lim High limit line impedance value



ΔU Voltage drop
Isc Prospective short-circuit current
Z Line impedance at measured point
Zref... Reference impedance

2.2.8 PE conductor resistance

1. Set function.

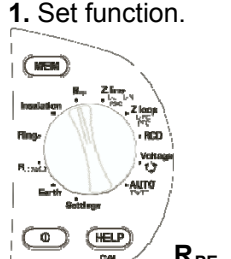

2. Set sub-function and limits

Selection of PE conductor resistance sub-function [Rpe, Rpe(rcd)]
Maximum resistance [OFF, 0.1 Ω ÷ 20.0 Ω]

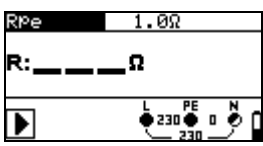

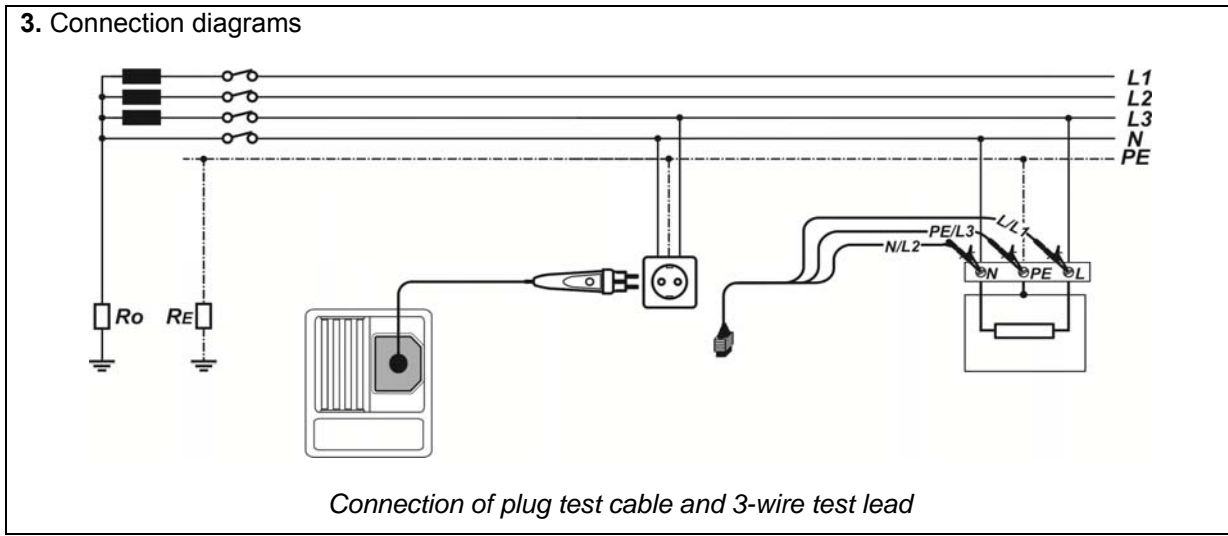

4. Press the  key.

5. View results and press the **MEM key to save them.**

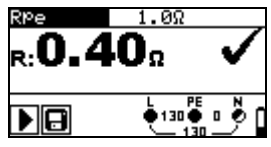

R..... PE conductor resistance

2.2.9 Earth resistance

1. Set function.

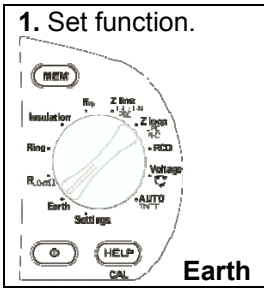

2. Set limits



Maximum resistance [OFF, 1 Ω ÷ 5 kΩ]

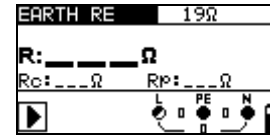

3. Connection diagrams

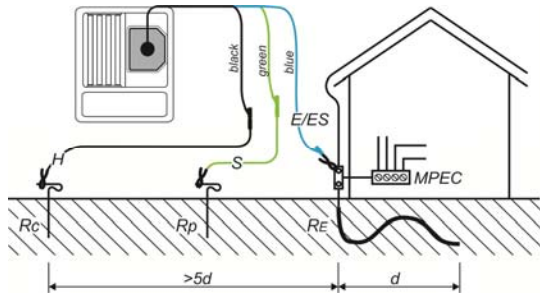

Resistance to earth – measurement of main installation earthing

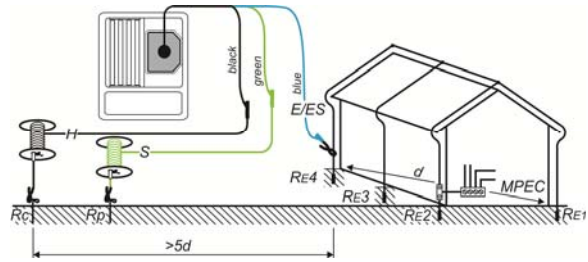

Resistance to earth, measurement of a lighting protection system

4. Press the key.

5. View results and press the **MEM** key to save them.



- R** Earth resistance
- Rp** Resistance of S (potential) probe
- Rc** Resistance of H (current) probe

2.3 Auto-sequences

1. Set function.

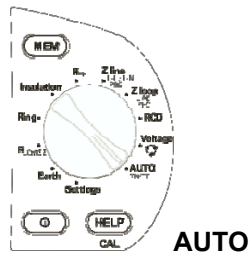

2. Set parameters and limits

Earthing system autotest [TT, TN(rcd), TN]

Fuse type [---, BS88-2, BS3036, BS88-3, BS1362, B, C, D]

Rated current of selected fuse

Maximum breaking time of selected fuse

High limit impedance value for selected fuse

Maximum voltage drop [3.0 % ÷ 9.0 %]

RCD type [AC, A; F]

Rated RCD residual current

sensitivity $I_{\Delta N}$ [10 mA, 30 mA, 100 mA, 300 mA, 500 mA, 1000 mA]

Starting polarity [~ , ~ , ~ , ~]

Characteristic [selective , general non-delayed

Conventional touchvoltage limit [25 V, 50 V]

Maximum PE resistance [OFF, 0.1 Ω ÷ 20.0 Ω]

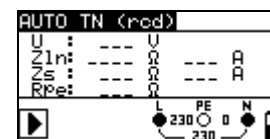
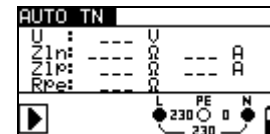
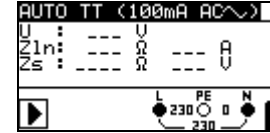

3. Connection diagrams

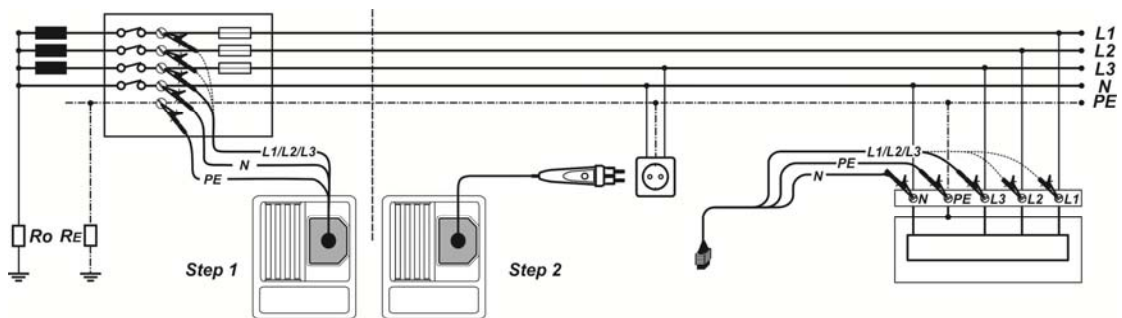

Auto-sequence setup

4. Press the key.

5. View results (press **HELP** key if multiple screens) and press the **MEM** key to save them.

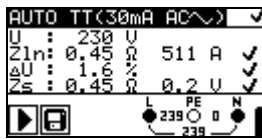

U Voltage between L and N
Zln ... Line impedance / prospective short-circuit current
 ΔU Voltage drop
Zs..... Loop impedance and contact voltage

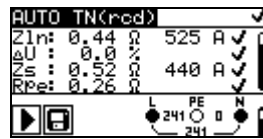

U..... Voltage between L and N
Zln.... Line impedance and prospective short-circuit current
 ΔU Voltage drop
Zs..... Loop impedance and prospective short-circuit current
Rpe .. PE resistance

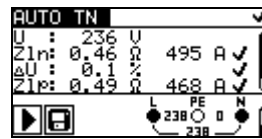

U..... Voltage between L and N
Zln Line impedance and prospective short-circuit current
 ΔU Voltage drop
Zlp Loop impedance and prospective short-circuit current
Rpe... PE resistance

