

# IDEA™ Drive

## User Manual



**Haydon**  
Motion Solutions



[www.haydonkerk.com](http://www.haydonkerk.com)

All Rights Reserved

1-2010

## Table of Contents

Revision History .....	4
IDEA DRIVE and Software Basics .....	5
Realtime Mode .....	5
Program Mode .....	6
Startup .....	8
Installing the Application .....	8
Initial Wiring Diagram .....	8
Getting Started .....	11
Drive Startup .....	12
Features and Concepts .....	13
Unit conversion .....	13
Communications Modes .....	13
Maximum Speed .....	14
Ramping .....	14
Saving programs to the drive .....	15
Removing Programs .....	15
Table of Contents .....	15
Startup Program .....	16
Saving/Loading/Combining programs .....	16
Autosave .....	16
Over Current Protection .....	17
Accel/Decel Current Boost .....	17
Password Protection .....	18
RS-485 Pin Descriptions .....	19
Debugger .....	<b>Error! Bookmark not defined.</b>
Inputs and Outputs .....	20
Simulating Inputs .....	23
Debugger .....	23
Encoder .....	24
Subroutines .....	25
Interrupts .....	26
Errors .....	28
Explanation of Commands .....	30
Extend .....	30
Retract .....	32
Move To .....	34
Go At Speed .....	36
Stop .....	38
E-Stop .....	39
Jump N Times .....	40
Goto .....	41
Goto If .....	42
Return .....	43
Return To .....	44

<b>Goto Sub</b> .....	45
<b>Wait</b> .....	46
<b>Wait For Move</b> .....	47
<b>Int on Pos</b> .....	48
<b>Int on Input</b> .....	49
<b>Encoder</b> .....	51
<b>Set Outputs</b> .....	52
<b>Set Position</b> .....	53
<b>Reset</b> .....	54
<b>Abort</b> .....	54
<b>Comment</b> .....	55
<b>Examples</b> .....	56
<b>Example One</b> .....	56
<b>Example Two</b> .....	60
<b>Example Three</b> .....	62
<b>Example Four</b> .....	66
<b>Example Five</b> .....	69
<b>Example Six</b> .....	74
<b>The IDEA drive menu bar</b> .....	78
<b>File</b> .....	78
<b>Edit</b> .....	78
<b>Mode</b> .....	78
<b>Drive Commands</b> .....	78
<b>Communications Mode</b> .....	79
<b>Programs on Drive</b> .....	79
<b>Help</b> .....	79
<b>Glossary</b> .....	80

## Revision History

<b>Date</b>	<b>Description</b>
January 2010	Initial version
February 2010	Save debug output Goto if updated for outputs Interrupt and encoder configuration update
January 2011	Added detail to the behavior of interrupts Added detail to the IO wiring diagram Stand alone IO wiring diagram RS-485 wiring Communications features
May 2011	Added RS-485 Pin descriptions Added minimum time between resets

## IDEA DRIVE and Software Basics

The Haydon Kerk Motion Solutions IDEA drive and associated software are a complete package for the easy control of stepper motor based linear actuators. This solution provides advanced features for both immediate execution as well as user written programs in an extremely user friendly way. All basic commands are used through intuitively named buttons, and each button and input field is further clarified through tooltips.

### Realtime Mode

Below is a screenshot of the User interface in the Realtime mode. This mode is only available when a drive is connected and communicating.

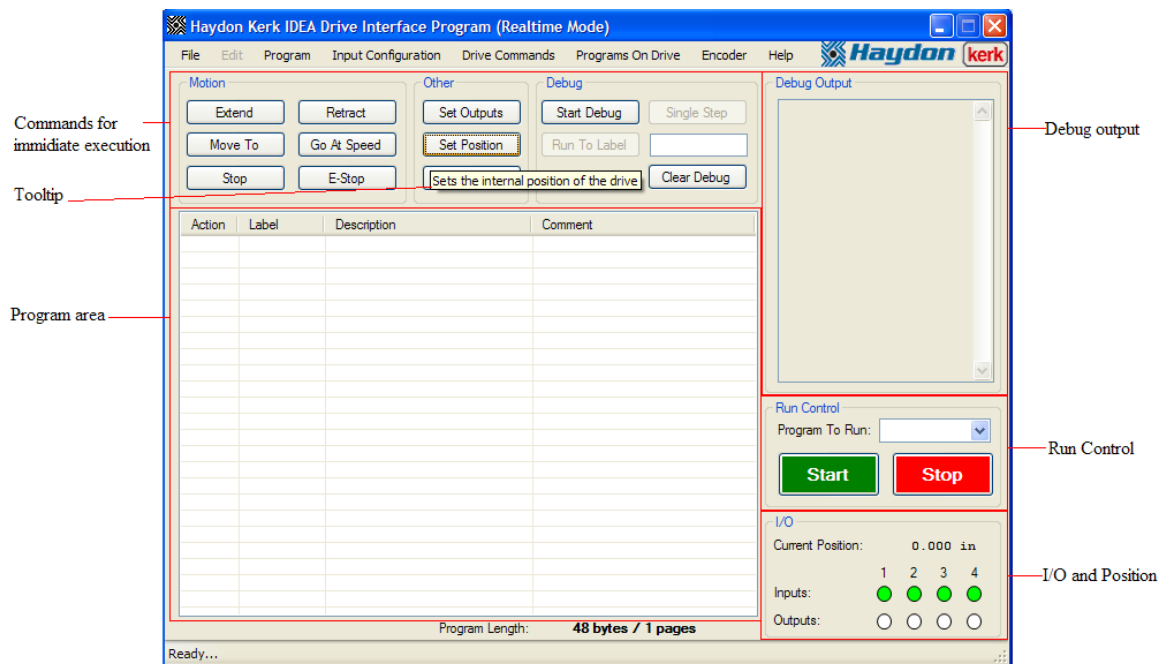

In the Realtime mode, each command executed from the “Commands for immediate execution” section elicits an immediate action from the drive.

The program area can display any program currently on the drive. These programs can be run or aborted using the “Run Control” section.

The I/O and position section provides constant feedback from the drive pertaining to the current state of the drive. This area can also be used to control the state of the outputs, as well as the inputs if in simulation mode.

The IDEA software provides a powerful debugging feature, which allows the user to enter debug mode, which causes every command in the program to be displayed in the “Debug Output” section as is it executed. This debugger can be run in two ways, manually telling the drive to execute one command at a time (“Single-stepping”), or executing multiple commands in a row until reaching one of the user programmed labels (“Run to Label”). Through this feature the ease of debugging complex programs is greatly increased.

### Program Mode

Below is a screenshot of the user interface in Program Mode. This mode is available even without a drive attached.

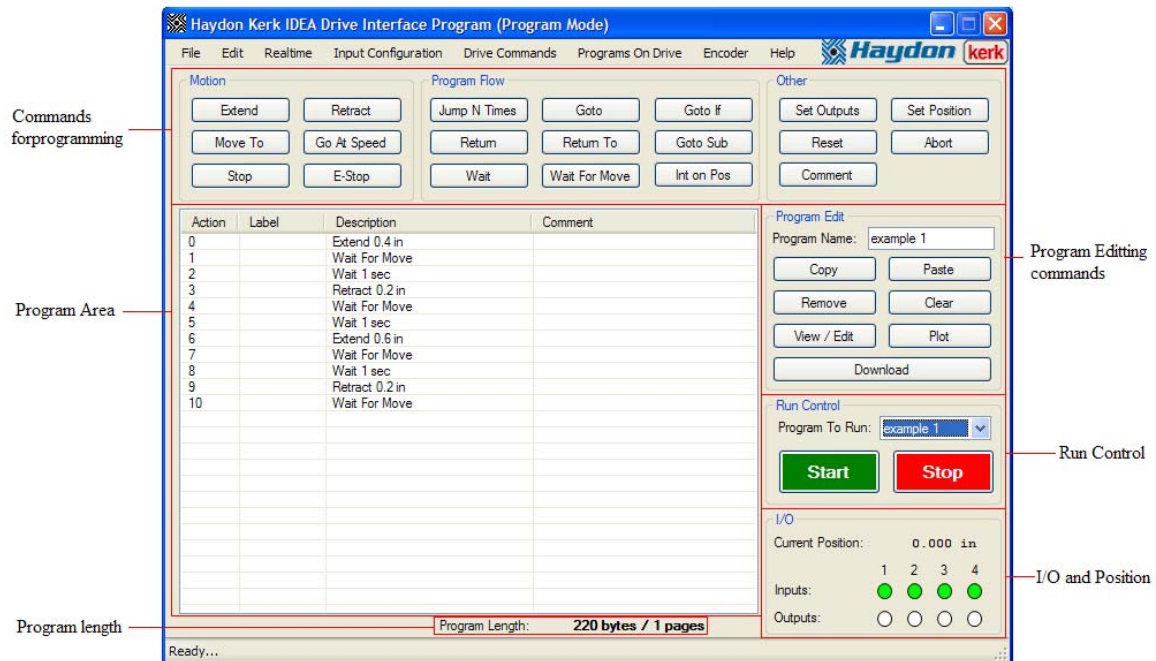

The I/O and position section provides constant feedback from the drive pertaining to the current state of the drive. This area can also be used to control the state of the outputs, as well as the inputs if in simulation mode.

The “Run Control” area can be used to execute or stop any program on the drive.

The “Program Edit” area contains buttons used to edit the program as well as gather information about individual commands. The download button is also in this area.

The “Program Area” contains the command that make up the program currently being viewed or edited. Commands in the program are executed sequentially, starting at action 1 and moving onto action 2 and so on, unless a branching command is used, which would send execution instead to a specified label. The different commands available are covered in depth below.

The size of the current program is displayed in both bytes and pages in the “Program Length” area. Each page is 1024 bytes long, and the number of pages used is always rounded up.

## **Startup**

**Installing the Application:** (This is a one time activity): The IDEA drive has a CD ROM disk that is to be installed into your PC. Please perform the following instructions: ( Note, this is to be performed without the actuator being attached via the USB cable )

- Insert the disk into the CD ROM drive.
- “Welcome to the IDEA Software setup wizard” will appear on screen. If this does not appear, go to “My Computer” and double click on the cd-rom drive. Click “next”
- “Select installation folder” will appear on screen. You may change the location of the installation if you wish. Click next.
- “Confirm installation” will appear on screen. Click next.
- “Installing IDEA Software” will appear on screen. This may take a few moments.
- “Installation complete” will appear on screen. A black function window will also appear behind the “Installation complete” dialogue box. This is normal. Do not close this window, it will close automatically. After a few moments the “Installation complete” dialogue box will show a “close” button. Click close.
- Installation is now complete and the IDEA Icon resides on your desktop and in your start menu under All Programs > Haydon Kerk.

**Initial Wiring Diagram:** To connect power to the actuator and control it with the idea drive you will need the following:

- A power supply, 12-48VDC.
- Power cable ( available from Haydon Kerk p/n 56-1348 )
- USB to Mini B USB cable ( available from Haydon Kerk p/n 56-1346 )



- 10 wire I/O cable (available from Haydon Kerk p/n 56-1352 ). Note: this cable is only required if the actuator is being communicated to from an external switch, etc. or the actuator is being programmed to send a signal to an outside device such as a light. ( or LED )
- If using the RS-485 enabled IDEA drive, you will also need the RS-485 converter (available from Haydon Kerk p/n UTC4852) and the RS-485 cable (available from Haydon Kerk p/n 56-1536).
- If using a stand alone drive, you will need to either have a motor with the appropriate connector attached to the leads, or use the motor connector assembly (available from Haydon Kerk p/n 56-1453) and attach the leads of the motor to the leads of the wire assembly.
- The following is the proper wiring diagram for the IDEA drive, power supply and PC. The I/O cable is omitted for initial programming instructions.

### USB Wiring Diagram

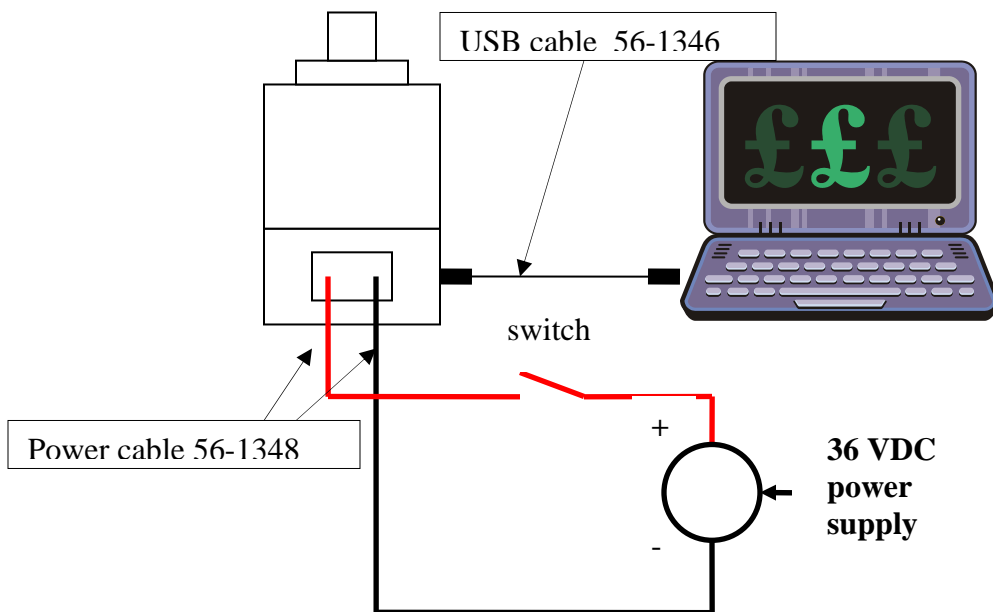

## RS-485 Wiring Diagram

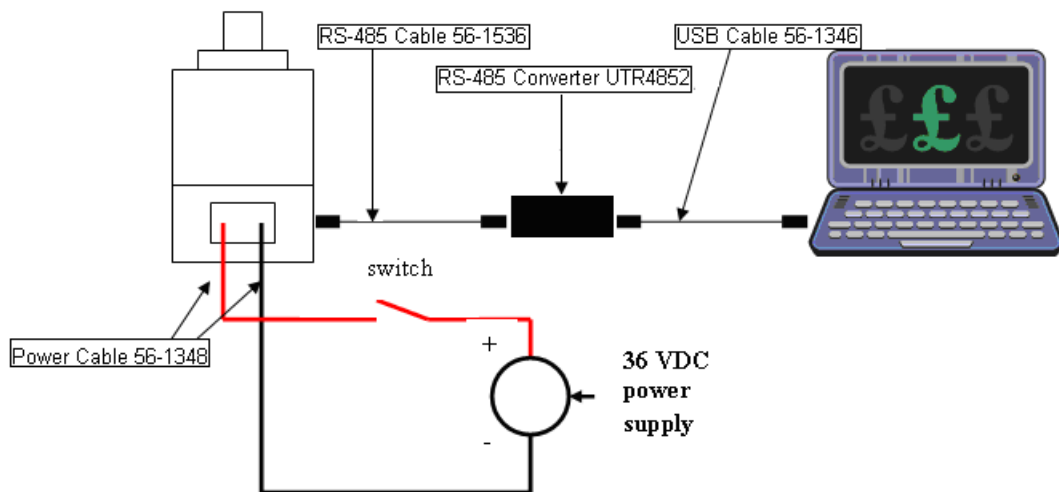

- After wiring as shown, turn on power supply and close the switch.

**Getting Started:** Let us assume that the GUI software and drivers have been loaded into your PC and the drive is connected and powered up. Please proceed as follows:

- Start your PC.
- Double-Click the IDEA Icon on your desktop. This brings you to the initial screen. Screen shot is below:

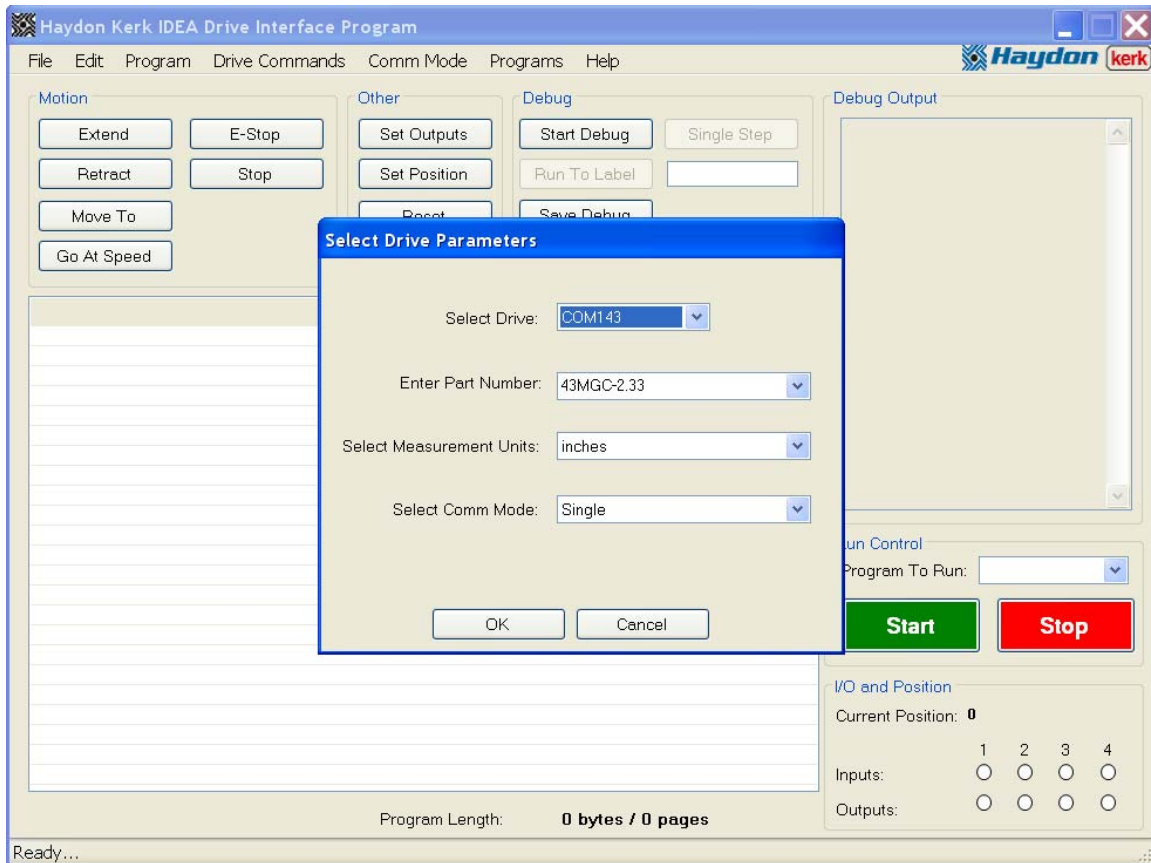

- Enter part number of the actuator.  
Note: this entry is not case sensitive.
- Select inches, mm or steps. Click OK.
  1. After clicking OK many parameters have been placed into memory for this particular actuator.
- Select the Communication mode

1. This will most likely be “Single”. The communications options are explained in the “Communications Modes” section of “Features and Concepts”.

Note: The com number will most likely be different from that shown above.

- The “Realtime” display now appears. This mode allows the program execute immediate actions such as extend, retract, go at speed, etc.

If the drive is not connected, or not turned on, you will not be able to select a drive, and when the program is entered, you will be forced into the program mode. If this happens when the drive is connected and powered up, try disconnecting and reconnecting the usb cable to the drive.

## **Drive Startup**

When the drive first starts up, either by turning the power on, or using the “Reset” command on a drive that was already powered, the following occurs:

1. Input simulation is turned off.
2. All outputs are set low.
3. The position counter is set to zero.
4. The hold current is set to zero.
5. All interrupts are disabled
6. The encoder is disabled.
7. If a startup program is selected, that program is now begun.

When a program is started, the following occurs:

1. All outputs are set low.
2. The position counter is set to zero.
3. All interrupts are disabled

## **Features and Concepts**

### **Unit conversion**

When starting the program, a part number and measurement unit must be selected. From this information, the number of steps for each command is calculated. This allows the user to write programs in their preferred units instead of having to calculate the number of steps. As with any conversion, some rounding error may be present. With a motor that was a .01" per step resolution, you cannot move .015" forward in full step mode. The user interface rounds this value down to the nearest microstep in the given step resolution. So if you wish to move .015" forward with a step resolution of .01", a step mode of ½ or finer must be selected. The program area will reflect the rounded value.

Note: In the case that the motor has been moved to a position between steps, if a new extend or retract is done from the position in a coarser step mode, the extend or retract will end on a position that is valid for the new step mode, and the distance traveled may not exactly match the desired distance. For example: If the motor has a resolution of .01" per step, and is moved to .015" using the half step mode, then a new extend of .02" is used in full step mode, the motor will extend .015" to the .03" position, which is a full step position.

### **Communications Modes**

There are four different modes that the user interface can be in for communications between it and any attached drives, these being offline, single, addressed and broadcast. You can change from one of these modes to any other, assuming the correct bus configuration is present, through the "Comm Mode" menu item in either the "Realtime" or "Program" screens.

- Offline: In this mode, no communication is present, so the "Realtime" screen is unavailable, as well as the drive commands and ability to program.

- **Single:** This is the simplest communication mode. In this mode, only 1 drive should be attached per USB port. All functions are available.
- **Addressed:** This mode is available for the command of one drive on a bus with multiple additional IDEA drives. This mode will behave the same as single mode, but can be used with multiple drives on a single bus, so long as each drive has a different identifier. Addresses can be set through the “Set Drive Address” menu item in the “Drive Commands” menu.
- **Broadcast:** In this mode, many drives can be on the same bus, regardless of their identifiers. This mode is more limited than single or addresses, as commands will be sent to the drives, but no messages will be received from the drives. All drives will execute any commands sent.

## **Maximum Speed**

Due to the speed of the microcontroller in the drive, and the number of calculations that are done for each step of a move profile, there is a maximum of 75000 steps that can be taken per second. The user interface will display the maximum speed for any move in the tooltip that pops up over the speed, start speed, and end speed textboxes.

## **Ramping**

The IDEA Drive provides easy to use acceleration and deceleration ramps. A trapezoidal move profile can be created by entering a speed, start speed, end speed, acceleration rate and deceleration rate. The drive automatically calculates a move profile to approximate the desired parameters. For a picture of what the calculated ramp will look like, use the plot function on any “Extend”, “Retract”, “Move To”, or “Go At Speed” command.

## **Saving programs to the drive**

After a program has been written, saving the program to the drive is simple. The program needs to be named, using the Program Name textbox. The program name may be up to 10 characters long, and cannot contain the “;” character. Any spaces at the end of the program name will not be saved, so “Program1” is the same as “Program1 ”. No two programs may have the same name, so attempting to download a program with the same name as an existing program will result in a warning, and continuing will cause the existing program to be overwritten.

When the download button is pressed, the user interface automatically finds the first area on the drive that can fit the program. If there is no place on the drive where the program can fit, the user is responsible for either moving or removing some programs. There are 85 pages of flash memory for user program, and each user program will likely take up 1 to 2 pages, so this scenario is unlikely. In order to move a program to free up larger blocks of free space, simply save the program to the drive again under the same name, and the program will be moved to the first page where it can be fit.

## **Removing Programs**

Programs can be removed from the IDEA drive in one of two ways. Either use the “Display Table of Contents” option under “Drive Commands”, then select the program to be removed in the list, then press “Remove” in the bottom left corner; or use the “Delete Program From Drive” option under “Drive Commands”, then select the program to be removed in the drop down menu and press “Ok”.

## **Table of Contents**

The IDEA Drive user interface provides a list of all programs on the drive, the pages being used by said programs, and a graphical representation of the contents and free space of the drive. This feature is accessed through the “Display Table of Contents” option under “Drive Commands”. This feature can be

helpful in freeing up space for additional programs, or seeing which programs could be moved to decrease fragmenting free space.

## **Startup Program**

In real world applications, the controller will need to start execution once power is applied, as opposed to being started through the user interface. In order to set a program to start on power up, the “set Startup Program” option under “Drive Commands” is used. In the associated window, the current startup program is displayed in bold, and a new startup program can be selected using the drop down menu of all programs currently on the drive. If it is desired to not have a startup program, “No Startup Program” should be selected.

## **Saving/Loading/Combining programs**

The IDEA user interface allows for programs to be saved to your computer or other drives. To do this, once the program is complete, go to “Save” in the “File” menu. This will open a save file dialog box. It is recommended that programs be backed up using the save function, to protect your work incase the program on the drive is overwritten.

To open a saved file, go to “Open” in the “File” menu. This will open an open file dialog box.

The IDEA user interface also provides the ability to combine two or more different programs. With a program open, go to “Add File” in the “File” menu. This will open an open file dialog. The file you select will be added to the end of the current program. This can be done multiple times to combine multiple programs.

## **Autosave**

The IDEA user interface provides an autosave feature to protect against losing all of your work. Once every minute, if the program is non-empty, the user interface automatically saves the file. If the program crashes, or is accidentally erased, the program can be recovered through the “Recover Autosave” option under the “File” menu. This will restore the most recently autosaved program.



Note: If you lose a program and wish to recover it through this feature, be sure not to open any other programs first. If this is done, the autosave feature may overwrite the file you wish to recover.

## **Over Current Protection**

The IDEA drive and user interface provide protection against overdriving the current in the actuator. When the user interface is opened, the part number entered for the motor provides the necessary information to calculate the maximum current of the motor. The user interface uses this to prevent the user from entering values that would be damaging to the motor.

When the user interface is started with a drive attached, the drive informs the user interface of the maximum current of the drive. The user interface then prevents the user from entering values that would be damaging to the drive.

The drive also has internal protections, so that if a program that was written for a larger drive is downloaded to a drive that cannot handle the current values in the program, and that program is run, the drive will abort the program and raise a drive current limit error.

## **Accel/Decel Current Boost**

The IDEA Drive provides the ability to boost the current for the acceleration ramp and deceleration ramp independently. If the acceleration current boost option is set to yes, then the current per phase will be 30% greater than the set run current during the acceleration ramp, if the ramp is 300ms or less in duration. For longer ramps, the current per phase will be increased for the first 300ms, and will be the set run current for the remainder of the ramp. The same is true for the deceleration ramp if the deceleration current boost is chosen, except that in the case of a ramp over 300ms, it will be the last 300ms of the ramp to be boosted.

Note: It is important for the user to ensure that the current boost feature is not over used. Repeated long ramp without rest can damage the motor if the boosted current is above the rated current of the motor.

## **Password Protection**

The IDEA drive has a password protection feature. When enabled, this feature prevents any program from being read back without the correct password. Passwords can be up to 10 characters in length and cannot contain the “,” character. Spaces at the end of the password are ignored, so “Password1” is the same as “Password1 ”.

Password protection does not prevent programs from being erased from or written to the drive. This feature is only meant to ensure that programs on password protected drives can not be copied by a third party.

Note: If a drive has been password protected and the password has been lost, there are two options. The first is to send the drive back to Haydon Kerk Motion Solutions, where the password can be recovered for a fee. The second option is to use the “Restore Factory Defaults” option under the “Drive Commands” menu. This will remove the password protection, but all programs on the drive will also be lost.

## RS-485 Pin Descriptions

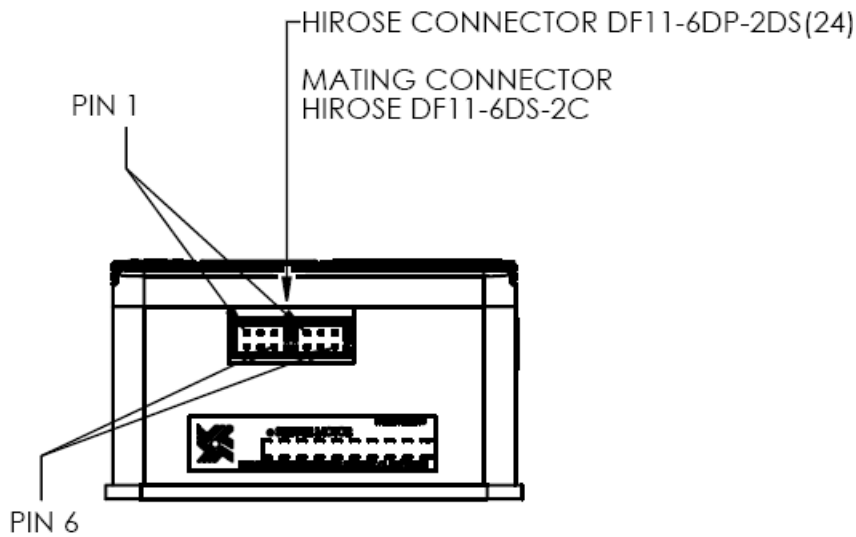
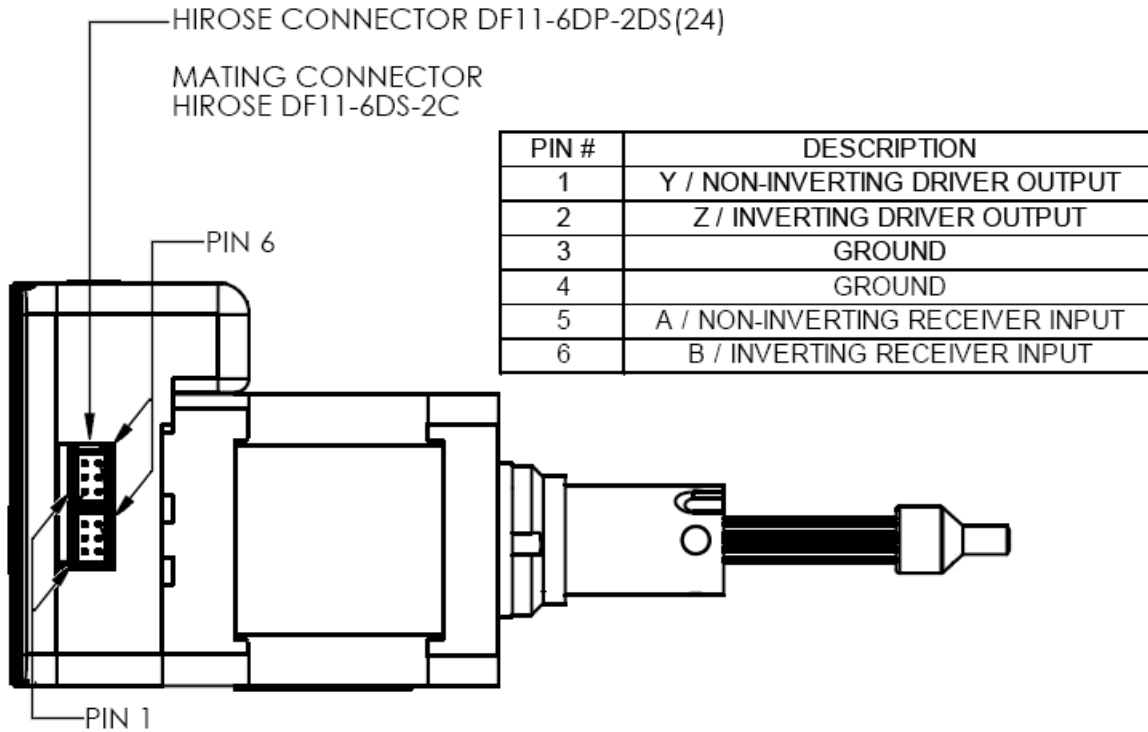

PIN #	DESCRIPTION
1	Y / NON-INVERTING DRIVER OUTPUT
2	Z / INVERTING DRIVER OUTPUT
3	GROUND
4	GROUND
5	A / NON-INVERTING RECEIVER INPUT
6	B / INVERTING RECEIVER INPUT

## Inputs and Outputs

Integrated drive I/O connector, pin identification:

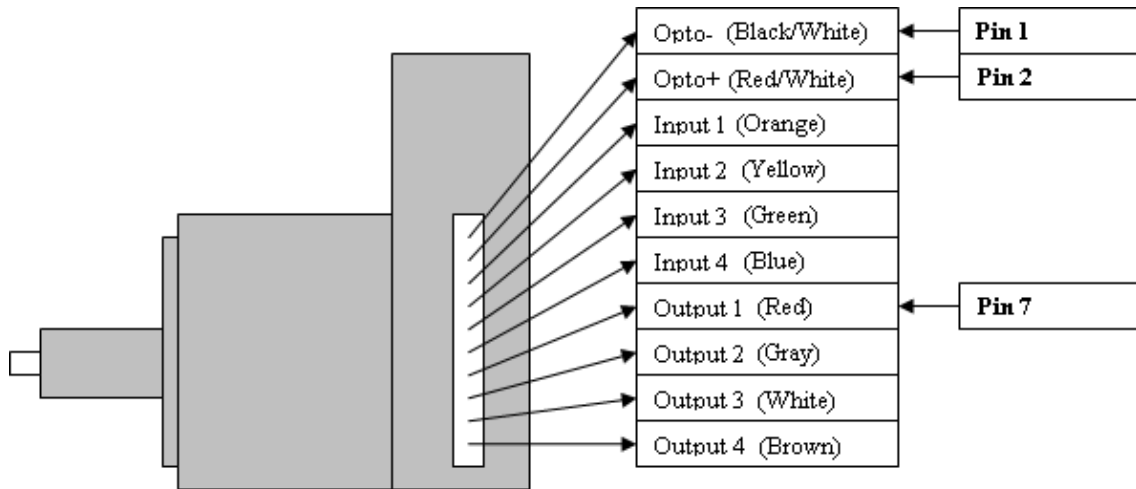

Stand alone drive I/O connector, pin identification:

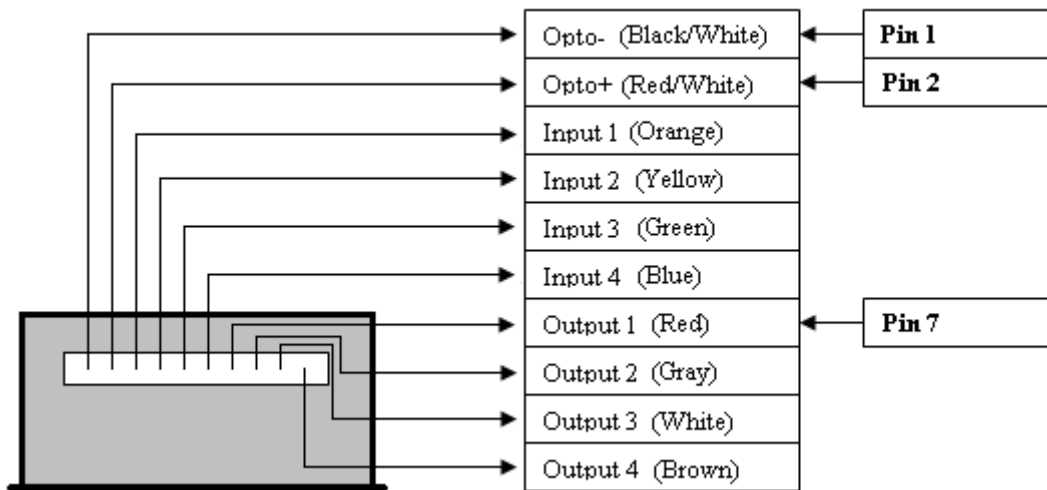

Open Collector Output Pin Diagram

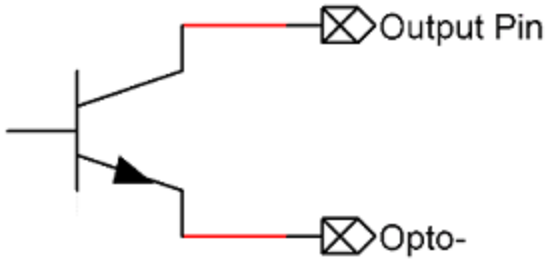

### Input Pin Diagram

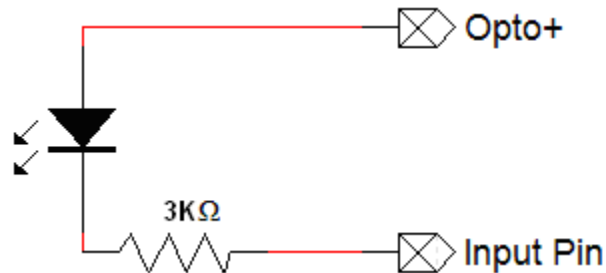

The IDEA drive has four optically isolated inputs and four optically isolated open-collector outputs. The voltage range for these is 5-24VDC. As the outputs are open-collector, they will need a pull-up resistor tied to the Opto-supply. The outputs are capable of sinking up to 200mA each.

Note: When an input is not connected to anything, it is seen as logic high. This allows connecting two IDEA drives without the use of pull-up resistors.

The inputs can be operated between 5 and 12VDC without any external components. For voltages above 12 VDC, an external dropping resistor is required to keep the current between 1mA and 4mA. The equation for the dropping resistor's resistance in Ohms is as follows:

$$((\text{Opto supply voltage} - 1.25)/0.0025) - 3000$$

The power rating of the resistor in watts should be at least:

$$\text{Resistance} * 0.0035 * 0.0035 * 2$$

Note: The inputs can be used in two ways. They can be connected to logic levels that swing between opto ground and opto supply, or they can be attached to a switch connected to opto ground. In the second configuration, when the switch is

open, the drive will see this as a logic high, when the switch is closed, and the input is connected to opto ground, the drive will see this as a logic low.

Note: When an input is connected to a mechanical switch or relay, a phenomenon called “bounce” can occur. When the switch contact is almost closed, several electrical arcs can form. If an input is being used as an interrupt, each arc will be seen as a rising and falling edge, causing several false interrupts to trigger. Any input being used as an interrupt source should only be attached to solid state devices or a switch with debounce circuitry.

In many cases, it is desirable to test a program that uses the inputs and outputs without actually connecting the hardware. In the bottom right hand corner of the user interface, there are eight circles, each representing one of the I/O. These show the current state of all the inputs and outputs, with a green filled circle representing logic high, and an empty circle representing logic low. While a program is not running, or while a program is being used in the debug mode, these output circles can be clicked to toggle the state of the outputs.

## **Simulating Inputs**

Since the inputs are controlled externally, under normal circumstances, the user does not control them through the user interface. If it is desired to control the inputs through the user interface, the “simulate Inputs” feature can be accessed through the “Drive Commands” menu. When this feature is turned on, the actual states of the inputs are ignored and the user interface tells the drive what state to consider the inputs to be.

Note: The simulate inputs feature can not be turned on or off while a program is running.

## **Debugger**

The IDEA user interface has a debugger to help in troubleshooting programs. The debugger is available in the Realtime mode. Once in the Realtime mode, the program to be debugged is selected either by the “Program to Run” drop down or through the “Programs on Drive” menu. Once the program is selected, the debug feature is started by pressing the “Start Debug” button. So long as the drive is in debug mode, each program line executed by the drive is displayed in the debug window. This window can be cleared at any time by using the “Clear Debug” button. The most recently executed command is also highlighted in the program area. Debug mode is exited by either pressing the red “Stop” button, or when the program ends.

There are two ways of advancing through programs in debug mode, single step and running to a label. Each time the “Single Step” button is pressed, the drive executes one command. If the button is pressed multiple times while the drive is on a “Wait” or “Wait For Move” command, the drive will not execute multiple commands after the completion of the wait.

When the “Run To Label” button is pressed, the drive begins to execute the program normally, until the label in the textbox to the right of the “Run To Label”

button is reached. If this label does not exist in the program, execution will continue until the red “Stop” button is pressed or execution ends on its own. Note: When the drive is executing many commands in a row without any “Wait” or “Wait For Move” commands, the user interface may be slowed due to the constant communication between the computer and the drive.

In order to aide in readability, as well as documentation, the debug output can be saved as a text file using the “Save Debug” button.

## **Encoder**

The IDEA drive can be purchased with an optional integral encoder. The IDEA drive offers several features related to the use of the encoder.

When the encoder feature is in use, the current position in the bottom right hand corner of the User interface is based upon the encoder, not the theoretical position based upon the number of steps taken.

The encoder has two modes of operation, “Stall Compensation” and “Position Verification”. The “Stall Compensation” feature works by keeping track of how many steps the drive has taken in any given move, and comparing that with the actual travel based on the encoder feedback. If the encoder feedback shows that the rotor of the motor is four full steps behind the theoretical position, the move will be stopped and restarted. This allows the drive to recover from a stall and complete the assigned move. Under this option the number of attempts must be entered. For any given move, the drive keeps track of how many times it has stopped and retried after a stall condition. The drive will only stop and retry a move as many times as are specified in the “Correction Attempts” textbox. The user can choose to have an interrupt trigger if the number of correction attempts is exhausted and the drive detects another stall. Interrupts are explained on page 24.

The second mode of operation with the encoder is “Position Verification”. With this feature, the user specifies some distance called a “Dead Band”. When this feature is enabled, whenever the motor is at a standstill, the drive checks to see



if the rotor is in within the dead band distance from the desired position. If within this distance, no action is taken, if outside this distance, the drive automatically moves to correct the error. This feature is constantly active, so if the drive has stopped, and something hits the product, causing it to move out of position, this feature will automatically correct for the movement.

Both encoder features can be active at once, the stall compensation feature being used during moves, and the position verification be used at standstill.

Note: If the encoder feature is enabled on a device that does not have an encoder, the unit will not run and errors will be reported.

## **Subroutines**

A subroutine is a sequence of commands that can be used from anywhere in the program. When a subroutine is called, the address of the next command that was going to be executed is stored on what is called a stack. When the subroutine is exited using the “Return” command, execution of the program resumes at the address that was stored on the stack. A maximum of 10 addresses can be held in the stack. If there are 10 addresses on the stack, and another subroutine is called without a subroutine completing, a “Stack Overflow” error will be asserted and program execution will abort. It is up to the user to ensure that stack overflows do not occur.

Subroutines are exited using one of two commands, “Return” or “Return to”. When “Return” is used, program execution resumes at the address stored on the stack. When “Return To” is used, a destination address is specified. Execution now resumes at the label specified, and the stack is emptied. The use of “Return to” exits all subroutines at once.

If a “Return” or “Return To” command is used when the stack is empty, a “Stack Underflow” error will be asserted and execution of the program will halt. It is the responsibility of the user to ensure that stack underflows do not occur.

There are two ways in which a subroutine can be called; the simplest is the “Goto Sub” command. A “Goto Sub” command is used to call a subroutine from within the program, usually to complete a sequence of commands which is used repeatedly in the program. The address stored on the stack when a “Goto Sub” command is used is the address immediately after the “Goto Sub”.

The second way to call a subroutine is through interrupts. Interrupts can occur at any time, and are explained in the interrupts section, page 24. When a subroutine is called by an interrupt, the address stored in the stack is the address of the command which would have next been executed. If the interrupt is triggered during a “Wait” or “Wait For Move” command, the address of the “Wait” or “Wait For Move” command is stored, and if the subroutine is exited by the “Return” command, the wait is resumed until it’s completion. Note: If a “Wait” command is interrupted, the time spent executing the interrupt or interrupts counts toward the “Wait” command’s delay time.

## **Interrupts**

The IDEA drive has three different types of interrupts, input triggered, position triggered and encoder triggered. All three operate in the same fashion, the difference being only how they are triggered.

When an interrupt is triggered, it branches to a subroutine with a specific priority. All interrupts need two parameters, the label of the subroutine to be run when triggered and the priority. For more information on subroutines, see Subroutines, page 22.

The priority of the interrupt determines the order in which any pending interrupts are serviced. If an interrupt is triggered while a lower priority interrupt is being serviced, the program immediately begins servicing the new interrupt. If an interrupt is triggered while an interrupt of equal or higher priority is being serviced, the new interrupt is put into a queue of pending interrupts and will be

serviced when all higher priority interrupts have been serviced and any interrupts of the same priority which were triggered first have been serviced.

There are 5 interrupt queues, one for each priority level, each being 10 interrupts long at most. If there are 10 interrupts in one queue, and another interrupt of that priority is triggered, the new interrupt will be ignored and an “Interrupt queue full” error will be asserted.

If an interrupt is reconfigured to trigger a new subroutine when there is an instance of that interrupt in a queue, the interrupt in the queue will still execute, but will execute the new subroutine, not the subroutine that the interrupt was originally configured to jump to. Care should be taken when programming ensure this does not occur.

Input Triggered: Each input can be configured to trigger an interrupt through the “Int on Input” button. The “INT” radio button should be selected for any input which is to be used as an interrupt source.

The trigger type should also be selected. The types are:

Rising edge: Occurs when the input level goes from low to high.

Falling edge: Occurs when the input level goes from high to low.

Both edges: Occurs anytime the input changes state.

Position triggered: Using the “Int On Position” command in a program, an interrupt can be set to trigger when the motor reaches a specific position.

Encoder triggered: When the “Stall Detection” encoder feature is used, an interrupt can be triggered when the number of “Correction attempts” has been exceeded.

## Errors

During operation, the user interface may report an error, below is an explanation of each of these errors.

**IO Error: An error occurred when attempting to update the IO:** This error occurs when communications between the drive and user interface is interrupted. This may happen on occasion when the drive is busy with a task and temporarily does not respond to the user interface. Press “Retry”. If the message continues to appear, check all connections.

**Stack Underflow:** This error occurs when a running program runs to a “Return” command while not within a subroutine. Check the running program for ways that the program could get to a “Return” without having used a “Goto Sub” or an interrupt.

**Stack Overflow:** This error occurs when 10 or more subroutines are called without returning. Check the running program to ensure that all subroutines end with either a “Return” or “Return To”, and that you are not nesting too many subroutines.

**Driver Overtemp:** This error occurs when the internal temperature of the drive exceeds a safe level. Consider moving the drive to a cooler location, reducing the hold and/or run currents, adding additional heat sinking, or adding active cooling.

**Encoder Error:** This error occurs when the encoder encounters a problem, or when the encoder feature is used without an encoder attached. If you do not have a unit with an encoder, do not turn on the encoder features. If you do have a unit with an encoder, and this error continues to occur, contact Haydon Kerk.

**Interrupt Queue Full:** This error occurs when a running program encounters more than 10 interrupts of the same priority without having serviced any. This

could occur due to an interrupt source causing multiple extraneous interrupts, or by one interrupt subroutine not returning, thus preventing execution of any other interrupts. Check your interrupt sources, and ensure that all interrupt subroutines end in a “Return” or “Return To” command.

**Loop Overflow:** This error occurs when a running program is in more than 10 “Jump N Times” commands at once. Ensure that the running program does not nest more than 10 “Jump N Times” commands.

**Drive Current Limit:** This error occurs when the drive is given a command with a current setting higher than its capability. Check that when you entered the user interface you set the correct part number for the motor, and that the drive you are using is appropriate for that motor.

**Bad Checksum, update aborted:** This error is most likely caused by communications being interrupted during a firmware update. Hit “OK” and attempt to update the firmware again. If the problem persists, contact Haydon Kerk.

**Unknown Error:** If you ever receive this error, make a note of what you were doing at the time, and contact Haydon Kerk.

## Explanation of Commands

### Extend

The extend command moves the actuator shaft a specified distance forwards from its current location.

Distance	<input type="text"/>	in	Accel Rate	<input type="text"/>	0	in/sec/sec	
Speed	<input type="text"/>	in/sec	Decel Rate	<input type="text"/>	0	in/sec/sec	
Run Current	<input type="text"/>	2.232	Ams	Start Speed	<input type="text"/>	0	in/sec
Hold Current	<input type="text"/>	0.558	Ams	End Speed	<input type="text"/>	0	in/sec
Delay Time	<input type="text"/>	0.05	sec	Accel Boost	<input type="text"/>	No	▼
Step Mode	<input type="text"/>	1	▼	Decel Boost	<input type="text"/>	No	▼
Total Time	<input type="text"/>		sec	Average Speed	<input type="text"/>		in/sec
Label	<input type="text"/>						
Comment	<input type="text"/>						

### Parameters

Distance: This is the distance that the actuator will extend.

Speed: This is the top speed at which the actuator will extend.

Run Current: This is the unboosted RMS current per phase that will be applied to the windings while the actuator extends.

Hold Current: This is the RMS current per phase that will be applied to the windings when the actuator finishes extending.

Delay Time: This is the time in between when the actuator reaches the last step in the extend, and when the current is changed to the hold current.

Step Mode: This is the step resolution to be used for this extend.

Accel Rate: This is the rate at which the actuator will be ramped from the start speed to the run speed. If this is set to 0, then the extend will start at the run speed.

Decel Rate: This is the rate at which the actuator will be ramped from the run speed to the end speed. If this is set to 0, then the extend will end at the run speed.

Start Speed: This is the speed at which the move will start, if an acceleration ramp is used.

End Speed: This is the speed at which the move will end, if a deceleration ramp is used.

Accel Boost: If set to yes, during acceleration, the current per phase applied to the windings will be 30% higher than the set run current, for a maximum of 300ms.

Decel Boost: If set to yes, during deceleration, the current per phase applied to the windings will be 30% higher than the set run current, for a maximum of 300ms.

The following program extends the actuator 1”, and waits for the move to complete before executing any commands which may follow:

Action	Label	Description	Comment
0		Extend 1 in	
1		Wait For Move	

This command is used in example 1.

## Retract

The retract command moves the actuator shaft a specified distance backwards from its current location.

Parameter	Value	Unit
Distance		in
Speed		in/sec
Run Current	2.232	Ams
Hold Current	0.558	Ams
Delay Time	0.05	sec
Step Mode	1	
Total Time		sec
Label		
Comment		
Accel Rate	0	in/sec/sec
Decel Rate	0	in/sec/sec
Start Speed	0	in/sec
End Speed	0	in/sec
Accel Boost	No	
Decel Boost	No	
Average Speed		in/sec

### Parameters

**Distance:** This is the distance that the actuator will retract.

**Speed:** This is the top speed at which the actuator will retract.

**Run Current:** This is the unboosted RMS current per phase that will be applied to the windings while the actuator retracts.

**Hold Current:** This is the RMS current per phase that will be applied to the windings when the actuator finishes retracting.

**Delay Time:** This is the time in between when the actuator reaches the last step in the retract, and when the current is changed to the hold current.

**Step Mode:** This is the step resolution to be used for this retract.

**Accel Rate:** This is the rate at which the actuator will be ramped from the start speed to the run speed. If this is set to 0, then the retract will start at the run speed.



Decel Rate: This is the rate at which the actuator will be ramped from the run speed to the end speed. If this is set to 0, then the retract will end at the run speed.

Start Speed: This is the speed at which the move will start, if an acceleration ramp is used.

End Speed: This is the speed at which the move will end, if a deceleration ramp is used.

Accel Boost: If set to yes, during acceleration, the current per phase applied to the windings will be 30% higher than the set run current, for a maximum of 300ms.

Decel Boost: If set to yes, during deceleration, the current per phase applied to the windings will be 30% higher than the set run current, for a maximum of 300ms.

The following program retracts the actuator 1", and waits for the move to complete before executing any commands which may follow:

Action	Label	Description	Comment
0		Retract 1 in	
1		Wait For Move	

This command is used in examples 1, 2, 3, 4, 5 and 6.

## Move To

The move to command moves the actuator shaft to a specific location, based upon the internal position counter or encoder.

Position	<input type="text"/>	in	Accel Rate	<input type="text"/>	in/sec/sec
Speed	<input type="text"/>	in/sec	Decel Rate	<input type="text"/>	in/sec/sec
Run Current	<input type="text"/>	Ams	Start Speed	<input type="text"/>	in/sec
Hold Current	<input type="text"/>	Ams	End Speed	<input type="text"/>	in/sec
Delay Time	<input type="text"/>	sec	Accel Boost	<input type="text"/>	
Step Mode	<input type="text"/>		Decel Boost	<input type="text"/>	
Label	<input type="text"/>				
Comment	<input type="text"/>				

Buttons: Plot, Add At End, Cancel

### Parameters

Position: This is the position to which the actuator will move.

Speed: This is the top speed at which the actuator will move.

Run Current: This is the unboosted RMS current per phase that will be applied to the windings while the actuator moves.

Hold Current: This is the RMS current per phase that will be applied to the windings when the actuator finishes moving.

Delay Time: This is the time in between when the actuator reaches the last step in the move, and when the current is changed to the hold current.

Step Mode: This is the step resolution to be used for this move.

Accel Rate: This is the rate at which the actuator will be ramped from the start speed to the run speed. If this is set to 0, then the move will start at the run speed.

Decel Rate: This is the rate at which the actuator will be ramped from the run speed to the end speed. If this is set to 0, then the move will end at the run speed.

Start Speed: This is the speed at which the move will start, if an acceleration ramp is used.

End Speed: This is the speed at which the move will end, if a deceleration ramp is used.

Accel Boost: If set to yes, during acceleration, the current per phase applied to the windings will be 30% higher than the set run current, for a maximum of 300ms.

Decel Boost: If set to yes, during deceleration, the current per phase applied to the windings will be 30% higher than the set run current, for a maximum of 300ms.

The following program moves the actuator to a point 1” forward from where the motor was at the beginning of the program, and waits for the move to complete before executing any commands which may follow:

Action	Label	Description	Comment
0		Move To 1 in	
1		Wait For Move	

This command is used in examples 4, 5, and 6.

## Go At Speed

The Go At Speed command moves the actuator shaft in a specified direction at a specified speed.

**Create Continuous Move Command**

Direction	Extend	Accel Rate	0	in/sec/sec
Speed		Decel Rate	0	in/sec/sec
Run Current	2.232	Start Speed	0	in/sec
Hold Current	0.558	End Speed	0	in/sec
Delay Time	0.05	Accel Boost	No	
Step Mode	1	Decel Boost	No	

Label:

Comment:

Plot Add At End Cancel

### Parameters

**Direction:** This is the direction in which the actuator will move.

**Speed:** This is the top speed at which the actuator will move.

**Run Current:** This is the unboosted RMS current per phase that will be applied to the windings while the actuator moves.

**Hold Current:** This is the RMS current per phase that will be applied to the windings when the actuator finishes moving.

**Delay Time:** This is the time in between when the actuator reaches the last step in the move, and when the current is changed to the hold current.

**Step Mode:** This is the step resolution to be used for this move.

**Accel Rate:** This is the rate at which the actuator will be ramped from the start speed to the run speed. If this is set to 0, then the move will start at the run speed.

Decel Rate: This is the rate at which the actuator will be ramped from the run speed to the end speed. If this is set to 0, then the move will end at the run speed.

Start Speed: This is the speed at which the move will start, if an acceleration ramp is used.

End Speed: This is the speed at which the move will end, if a deceleration ramp is used.

Accel Boost: If set to yes, during acceleration, the current per phase applied to the windings will be 30% higher than the set run current, for a maximum of 300ms.

Decel Boost: If set to yes, during deceleration, the current per phase applied to the windings will be 30% higher than the set run current, for a maximum of 300ms.

The following program moves the actuator for 1 second.

Action	Label	Description	Comment
0		Go At Speed 1 in/sec	
1		Wait 1 sec	

This command is used in example 6.

## Stop

The Stop command brings the actuator to a stop with an optional deceleration ramp. This does not halt program execution.

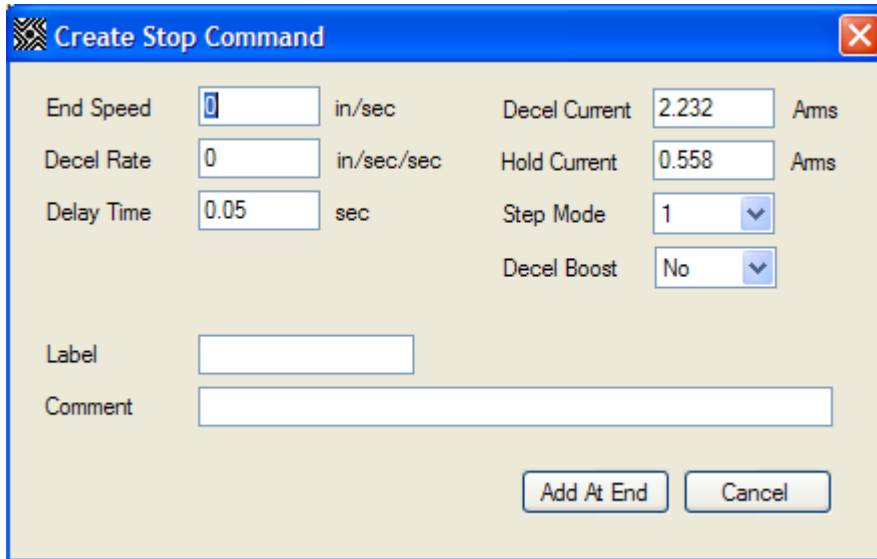

End Speed	<input type="text" value="0"/>	in/sec	Decel Current	<input type="text" value="2.232"/>	Ams
Decel Rate	<input type="text" value="0"/>	in/sec/sec	Hold Current	<input type="text" value="0.558"/>	Ams
Delay Time	<input type="text" value="0.05"/>	sec	Step Mode	<input type="text" value="1"/>	
			Decel Boost	<input type="text" value="No"/>	
Label	<input type="text"/>				
Comment	<input type="text"/>				

### Parameters

**End Speed:** This is the speed at which the move will end, if a deceleration ramp is used.

**Decel Rate:** This is the rate at which the actuator will be ramped from the run speed to the end speed. If this is set to 0, then the move will end at the run speed.

**Delay Time:** This is the time in between when the actuator reaches the last step in the move, and when the current is changed to the hold current.

**Decel Current:** This is the unboosted RMS current per phase that will be applied to the windings while the actuator stops.

**Hold Current:** This is the RMS current per phase that will be applied to the windings when the actuator finishes moving.

**Step Mode:** This is the step resolution to be used for this move.

**Decel Boost:** If set to yes, during deceleration, the current per phase applied to the windings will be 30% higher than the set decel current, for a maximum of 300ms.

The following program starts a move at 1” per second, waits 0.5 seconds, and the stops the actuator.

Action	Label	Description	Comment
0		Go At Speed 1 in/sec	
1		Wait .5 sec	
2		Stop	

This command is used in example 5.

## E-Stop

The E-Stop command brings the actuator to an immediate stop. This does not halt program execution.

### Parameters

**Decel Current:** This is the unboosted RMS current per phase that will be applied to the windings while the actuator stops.

**Hold Current:** This is the RMS current per phase that will be applied to the windings when the actuator finishes moving.

**Delay Time:** This is the time in between when the actuator reaches the last step in the move, and when the current is changed to the hold current.

The following program starts a move at 1” per second, waits 0.5 seconds, and the stops the actuator.

Action	Label	Description	Comment
0		Go At Speed 1 in/sec	
1		Wait 0.5 sec	
2		E-Stop	

## Jump N Times

The Jump N Times command goes to a specified label a specified number of times. Once the number of jumps has been completed, execution continues at the next line in the program, if any exist.

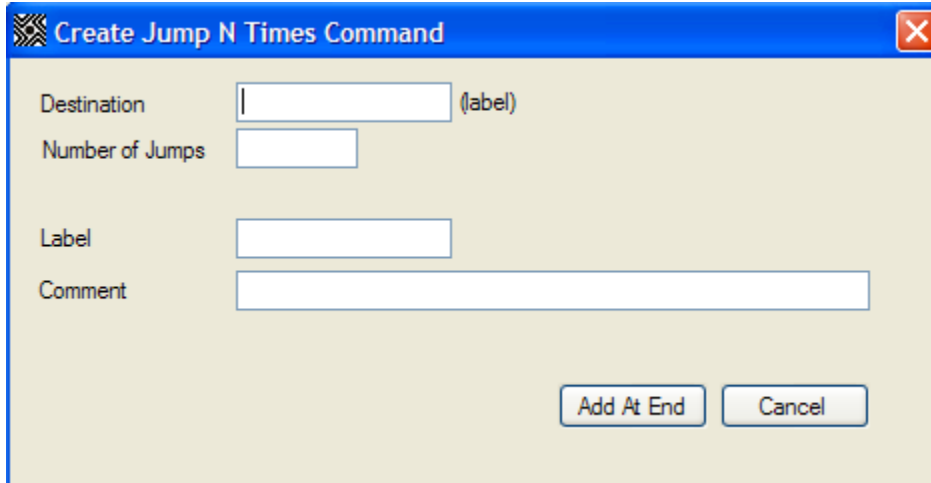

### Parameters

Destination: This is the label of the command that should be jumped to.

Number of Jumps: This is how many times the command should jump.

The following program extends .25", waits for the move to stop, then repeats 3 times.

Note: Because the command goes to the extend command 3 times from the jump n times command, the extend is performed a total of 4 times.

Action	Label	Description	Comment
0	extend	Extend 0.25 in	
1		Wait For Move	
2		Jump N Times extend	Number of Jumps: 3

This command is used in example 2.



## Goto

The Goto command goes to a specified label.

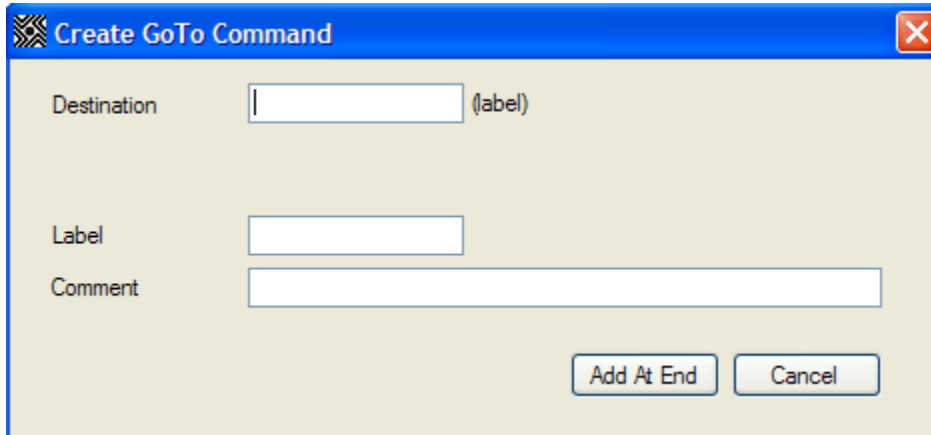

The screenshot shows a dialog box titled "Create GoTo Command". It features a blue title bar with a close button (X) in the top right corner. The main area is light beige and contains three input fields: "Destination" (with a "(label)" suffix), "Label", and "Comment". At the bottom right, there are two buttons: "Add At End" and "Cancel".

## Parameters

Destination: This is the label of the command to which the program will go.

The following program extends .25", waits for the move to stop, then repeats until the program is aborted.

Action	Label	Description	Comment
0	extend	Extend 0.25 in	
1		Wait For Move	
2		Goto extend	

This command is used in examples 1, 5 and 6.

## Goto If

The Goto If command goes to a specified label if the current states of the inputs match the specified conditions.

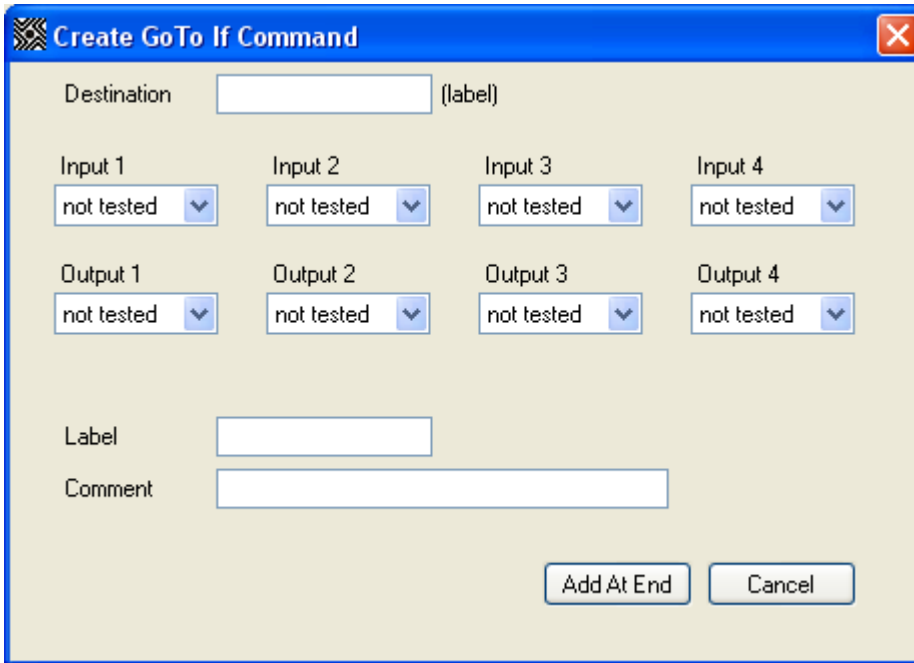

### Parameters

Destination: This is the label of the command that should be jumped to.

Inputs/Outputs: Each I/O can be specified as High, Low, or not tested. Any I/O set to "Not Tested" will be ignored; the state of the I/O when the command is executed must match all settings of high or low in order to go to the specified label, otherwise, the next line of the program is executed.

The following program extends .25", waits for the move to stop, then repeats so long as input 1 is high and input 2 is low.

Action	Label	Description	Comment
0	extend	Extend 0.25 in	
1		Wait For Move	
2		Goto If extend	1 set to high. 2 set to low

This command is used in example 5.

## Return

The return command ends a subroutine and returns execution to the location from which the subroutine was called. For further explanation of subroutines, see Subroutines, page 22.

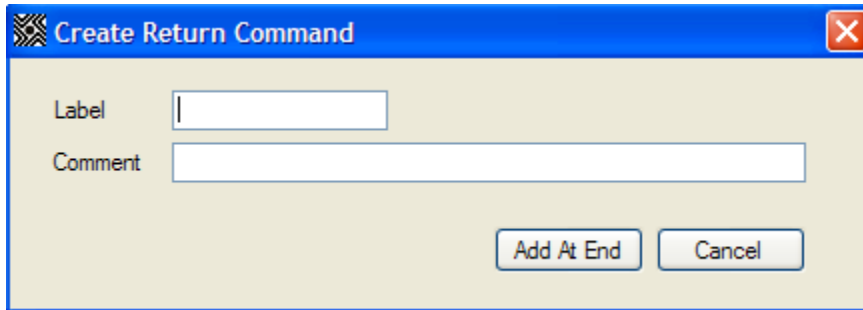

The screenshot shows a dialog box titled "Create Return Command". It has a blue title bar with a close button (X) in the top right corner. The main area is light beige and contains two input fields: "Label" and "Comment". Below the input fields are two buttons: "Add At End" and "Cancel".

## Parameters

This command has no parameters.

The following program runs a subroutine starting at label extend, which extends the actuator 0.25", waits for the move to complete, then returns, then repeats.

Action	Label	Description	Comment
0	start	Goto Sub extend	
1		Goto start	
2			
3	extend	Extend 0.25 in	
4		Wait For Move	
5		Return	

This command is used in example 3.

## Return To

The return to command ends a subroutine, clears the stack, clears any pending interrupts, clears any “Jump N Times” commands, and goes to a specified label. For further explanation of subroutines, see Subroutines, page 22.

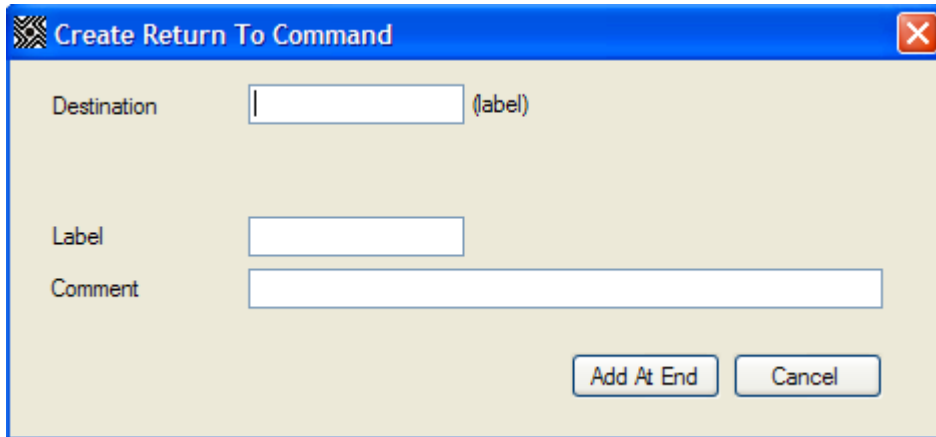

The screenshot shows a dialog box titled "Create Return To Command". It has a blue title bar with a close button (X) in the top right corner. The main area is light beige and contains three input fields: "Destination" (with a "(label)" suffix), "Label", and "Comment". At the bottom right, there are two buttons: "Add At End" and "Cancel".

### Parameters

Destination: The label of the command that should be executed next.

The following program runs a subroutine starting at label extend, which extends the actuator 0.25”, waits for the move to complete, then exits the subroutine, goes to the abort command, and aborts the program.

Action	Label	Description	Comment
0	start	Goto Sub extend	
1		Goto start	
2			
3	extend	Extend 0.25 in	
4		Wait For Move	
5		Return To abort	
6			
7	abort	Abort	

This command is used in example 6.

## Goto Sub

The Goto Sub command goes to a subroutine starting with the specified label. For further explanation of subroutines, see Subroutines, page 22.

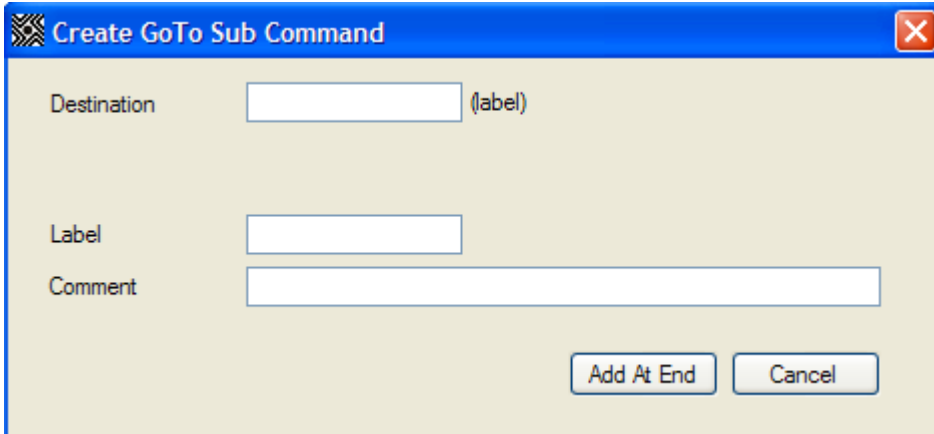

The screenshot shows a dialog box titled "Create GoTo Sub Command". It has a blue title bar with a close button. The dialog contains three input fields: "Destination" with a "(label)" hint, "Label", and "Comment". At the bottom right are "Add At End" and "Cancel" buttons.

### Parameters

Destination: This is the label of the command that is the start of the subroutine.

The following program runs a subroutine starting at label extend, which extends the actuator 0.25", waits for the move to complete, then returns, then repeats.

Action	Label	Description	Comment
0	start	Goto Sub extend	
1		Goto start	
2			
3	extend	Extend 0.25 in	
4		Wait For Move	
5		Return	

This command is used in example 3.

## Wait

The wait command delays execution of the next command in the program for a specified time.

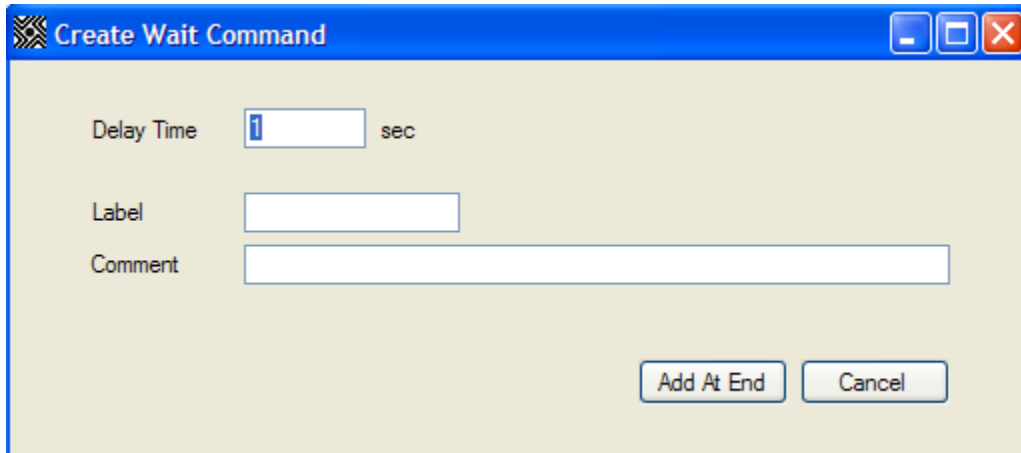

### Parameters

Delay Time: The amount of time that the program should wait.

The following program begins moving the actuator at 1" per second, waits 0.5 seconds, then stops the actuator.

Action	Label	Description	Comment
0		Go At Speed 1 in/sec	
1		Wait 0.5 sec	
2		Stop	

This command is used in examples 1, 3, and 4.

## Wait For Move

The Wait For Move command delays execution of the next command in the program until a move has completed. This command is automatically added after every Extend, Retract, and Move To, but can be removed if necessary.

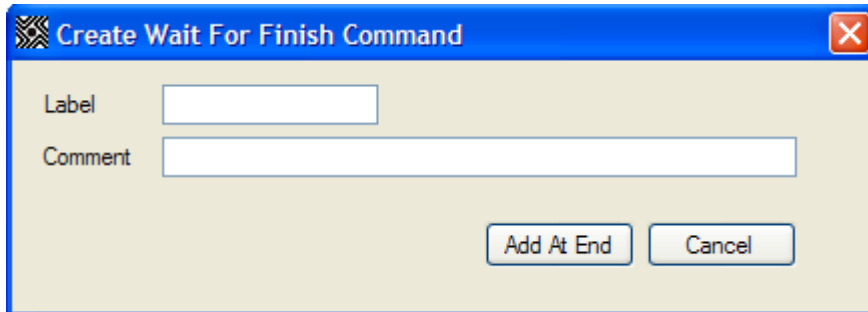

### Parameters

This command has no parameters.

The following program extends the actuator 1", and waits for the move to complete before executing any commands which may follow:

Action	Label	Description	Comment
0		Extend 1 in	
1		Wait For Move	

This command is used in examples 1, 2, 3, 4, 5, and 6.

## Int on Pos

The int on pos command sets an interrupt to be triggered when the actuator reaches a specified position. For further explanation of interrupts, see Interrupts, page 24.

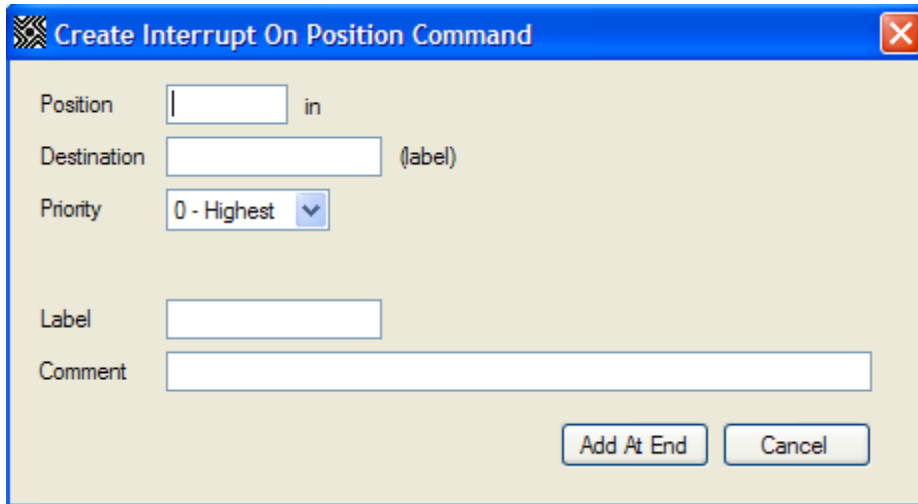

### Parameters

Position: The position, based upon the position counter of the drive, at which the interrupt should be triggered.

Destination: The label of the subroutine that should be executed when the position is reached.

Priority: The priority of the interrupts.

Note: If an interrupt is set for a position, and the position counter is adjusted through the use of the “Set Position” command, the interrupt will still occur at the same point.

Example: The drive is turned on, and an interrupt is set on position 0.5”. The “set Position” command is then used, changing what was the 0” position to the 1” position. The interrupt will now trigger when the drive’s position counter reaches 1.5”.



The following program sets an interrupt at position 1”, and then begins extending. When the actuator reaches the 1” position, the interrupt is triggered and the program aborts.

Action	Label	Description	Comment
0		Int On Position 1 in	Destination: abort
1		Go At Speed 1 in/sec	
2		Wait For Move	
3			
4	abort	Abort	

This command is used in example 6.

## Int on Input

The Interrupt on Input command allows an interrupt to be triggered when any of the inputs are changed. For further explanation of interrupts, see Interrupts, page 24.

**Create Interrupt on Input Command**

**Input 1 Interrupt**  
 Disabled  Enabled  Destination:  Trigger Type: Falling Edge Priority: 0 - Highest

**Input 2 Interrupt**  
 Disabled  Enabled  Destination:  Trigger Type: Falling Edge Priority: 0 - Highest

**Input 3 Interrupt**  
 Disabled  Enabled  Destination:  Trigger Type: Falling Edge Priority: 0 - Highest

**Input 4 Interrupt**  
 Disabled  Enabled  Destination:  Trigger Type: Falling Edge Priority: 0 - Highest

Label:   
 Comment:

Add At End Cancel

## Parameters

Each input has the same parameters.

Disabled/Enabled: Select “Enabled” if the input should cause an interrupt, select “Disabled” otherwise.

Destination: This is the label for the subroutine associated with the interrupt.

Trigger Type: If “Falling Edge” is selected, the interrupt will be triggered when the input goes from a logic high to a logic low. If “Rising Edge” is selected, the interrupt will trigger when the input goes from logic low to logic high. If “Both Edges” is selected, the interrupt will trigger any time the state of the input changes.

The following program sets an interrupt for the rising edge of input 1, and then loops continuously. When input one changes to logic high, output 1 is set to high.

Action	Label	Description	Comment
0		Int on Input INT, GP, GP, GP	
1	goto	Goto goto	
2	set Output	Set Outputs H X X X	
3		Return	

## Encoder

The Encoder command sets the encoder configuration. For more information on the encoder feature, see Encoder, page 21.

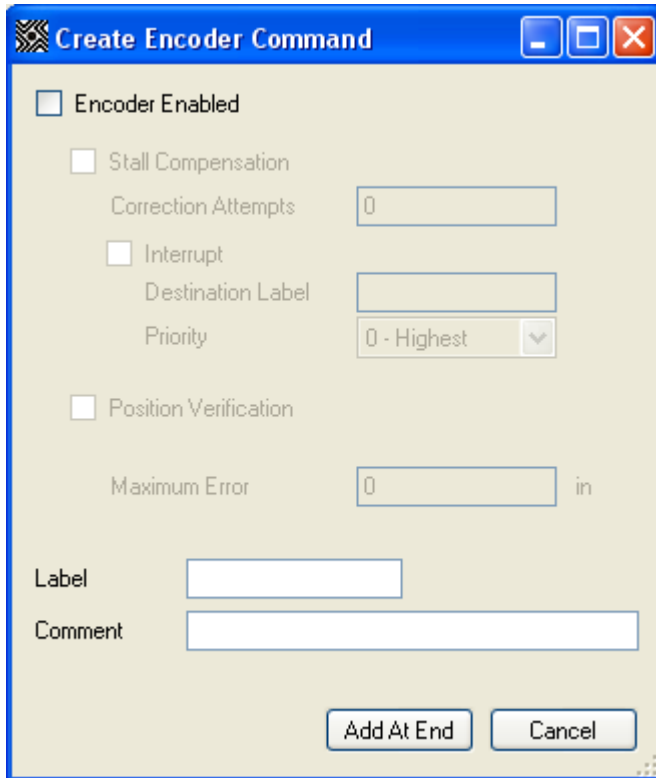

### Parameters

**Encoder Enabled:** If any of the encoder features are to be used, this must be selected.

**Stall Compensation:** If this is selected, any time the motor stall during a move, the drive will stop and the move and try again, up to the number of times specified in Correction attempts.

**Correction Attempts:** The number of times the drive should attempt any given move.

**Interrupt:** Select this if you want an interrupt to be triggered when the drive has exhausted the correction attempts.

**Destination Label:** This is the label of the subroutine that should be called when the correction attempts are exhausted.

**Priority:** This is the priority of the interrupt

Position verification: This should be selected if the position verification feature is to be used.

Maximum Error: This is the allowable distance from the desired position. If the drive is farther from the desired position, it will move to correct.

The following program configures the encoder and then extends.

Action	Label	Description	Comment
0		Encoder Configuration Enabled	
1		Extend 1 in	
2		Wait For Move	

## Set Outputs

The Set Outputs command sets the logic state of the outputs.

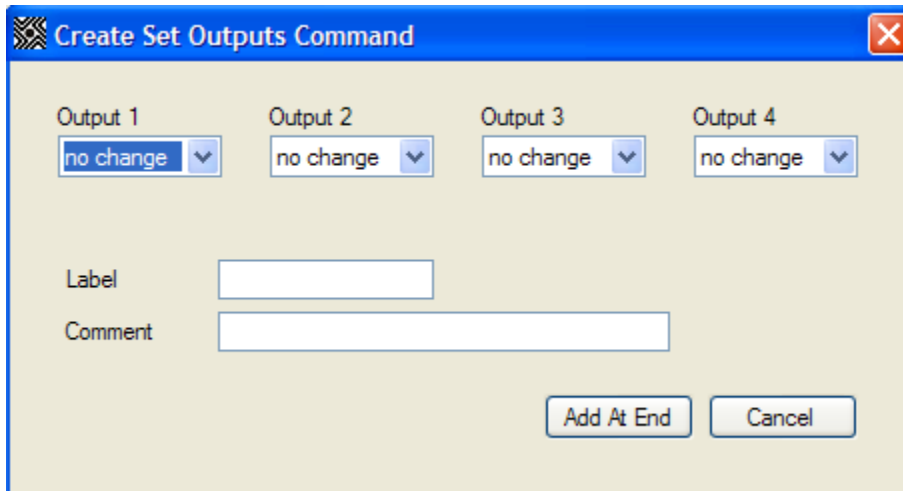

### Parameters

Outputs: Each output is individually set as either high, which will bring the outputs to the opto-supply voltage, low, which brings the output to the opto-ground voltage, or no change, which will leave the output in its current state.

The following program sets output 1 high, waits 0.5 seconds, and then sets output 1 low. During this outputs 2 3 and 4 are unchanged.

Action	Label	Description	Comment
0		Set Outputs H X X X	
1		Wait 0.5 sec	
2		Set Outputs L X X X	

This command is used in example 3.

## Set Position

The Set Position command sets the position counter of the drive to the specified value.



### Parameters

Position: The value to which the current position of the drive should be set.

The following program retracts the actuator 1", sets the position to 0", and then moves to the 0.5" position, which causes a 0.5" extend.

Action	Label	Description	Comment
0		Retract 1 in	
1		Wait For Move	
2		Set Position 0 in	
3		Move To 0.5 in	
4		Wait For Move	

This command is used in examples 4, 5, and 6.

## Reset

The Reset command restarts the drive, similar to turning the drive off and on. If used in a program, this command will not be executed less than 1/10<sup>th</sup> of a second after the drive has seen a reset, in order to prevent an uninterruptible cycle of resets.

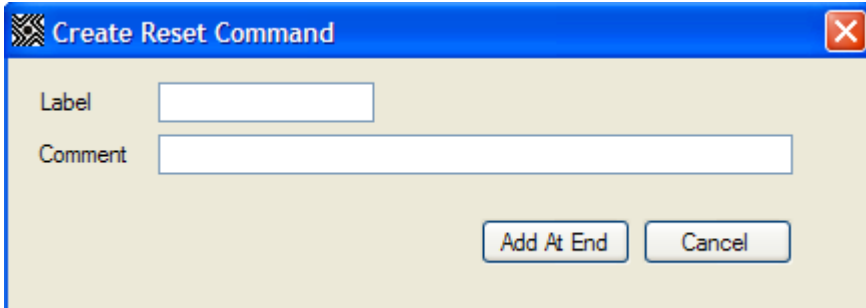

The screenshot shows a dialog box titled "Create Reset Command". It has a blue title bar with a close button (X) on the right. The main area is light beige and contains two text input fields: "Label" and "Comment". Below the fields are two buttons: "Add At End" and "Cancel".

## Parameters

This command has no parameters.

The following program resets the drive.

Action	Label	Description	Comment
0		Reset	Resets the device

## Abort

The abort command immediately stops any moves without deceleration, applies the last specified holding current and halts execution of any running program.

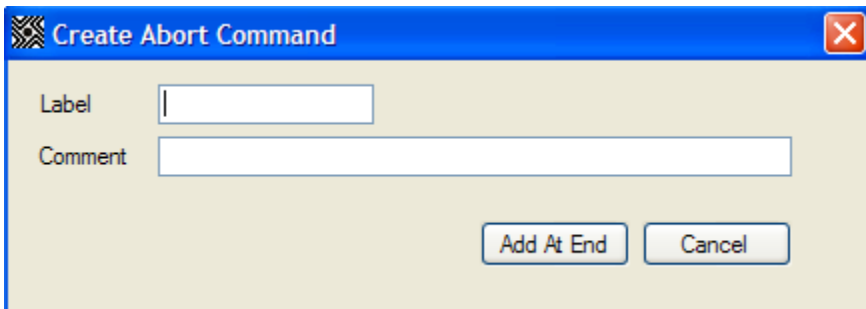

The screenshot shows a dialog box titled "Create Abort Command". It has a blue title bar with a close button (X) on the right. The main area is light beige and contains two text input fields: "Label" and "Comment". Below the fields are two buttons: "Add At End" and "Cancel".

## Parameters

This command has no parameters.

The following program aborts the program

Action	Label	Description	Comment
0		Abort	Ends the program

This command is used in examples 3 and 6.

## Comment

The comment command performs no action. This command is used to add extra information into a program for better documentation. Each comment line affords an additional 30 characters of comments. This command can also be used to add breaks between sections of code, making it more readable.

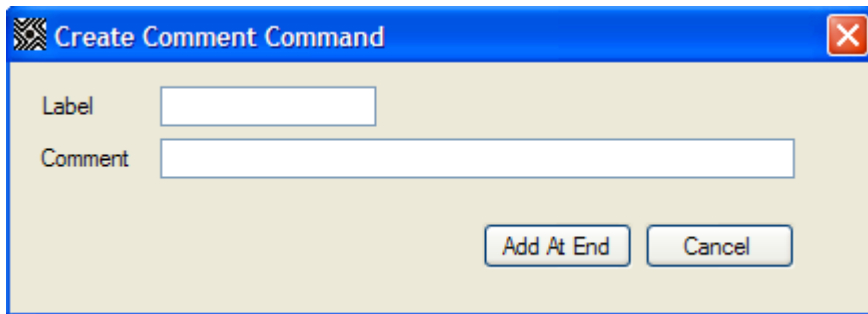

## Parameters

This command has no parameters.

The following program performs no actions.

Action	Label	Description	Comment
0			
1			
2			
3			
4			
5			
6			
7			

This program performs no function, but does help to demonstrate the usefulness of the comment command

By adding in a comment command without a comment, I have made a line break for readability.

## Examples

Because of the variety of actuators that this product can be used with, examples for every product, or a general example for all products can not be achieved. All of the following examples assume the use of a Haydon Kerk 43MBC-2.33 double-stack captive linear actuator with 1 inch stroke. Speeds, distances and other parameters will need to be changed for your particular actuator.

Note: For simplicity, most examples assume the actuator starts in the full retract position.

**Example One:** Extend the actuator 0.4 inches, wait one second, retract the actuator 0.2 inches, wait one second, extend the actuator 0.6 inches, wait 1 second, retract the actuator 0.8 inches, wait 1 second, and repeat from the first extend indefinitely. Let the linear speed for each move be 1 inch per second.

We first want to extend 0.4 inches.

- Click the “Extend” button.
- Input the distance as 0.4 inches.
- Input the speed as 1 inch per second.
- All other parameters can be left as the defaults.
- Enter “Start” as the label.
- You can add a comment in the comment line if you wish.
- Click the “Add At End” button. This places the command in program.

Note: You will notice that when the extend command populates in the program field on the screen, that it is followed by a second command that states “Wait For Move“. This is also true when using the Retract and Move To commands. This is a command to allow the move to finish before execution of the next command.

We now want to wait 1 second before moving again.



- Click the “Wait” button.
- Input the delay time as 1 second. No label or comment is necessary.
- Click “Add At End”. This places this command into the program.

We now want to retract 0.2 inches.

- Click the “Retract” button.
- Input the distance as 0.2 inches
- Input the speed as 1 inch per second
- No Label is required.
- You can add a comment in the comment line if you wish.
- Click the “Add At End” button. This places the command in program.

We now want to wait another second.

- Click the “Wait” button.
- The delay time will be 1 second, as previously entered. No label or comment is necessary.
- Click “Add At End”. This places this command into the program.

We now want to extend 0.6 inches.

- Click the “Extend” button. As before, many items are already populated. This time the distance and speed are also populated.
- Input the distance as 0.6 inches
- No Label is required.
- You can add a comment in the comment line if you wish.
- Click the “Add At End” button. This places the command in program.

We now want to wait one second.

- Click the “Wait” button.
- The delay time will be 1 second as previously entered. No label or comment is necessary.

- Click “Add At End”. This places this command into the program.

We now want to make the final move of retracting 0.8 inches.

- Click the “Retract” button.
- Input the distance as 0.8 inches
- No Label is required.
- You can add a comment in the comment line if you wish.
- Click the “Add At End” button. This places the command in program.

We now want to wait one second.

- Click the “Wait” button.
- The delay time will be 1 second as previously entered. No label or comment is necessary.
- Click “Add At End”. This places this command into the program.

We now want to repeat.

- Click the “Goto” button.
- Enter the destination as “Start”.
- Click “Add At End”. This places this command into the program.

The completed program looks as follows:

Haydon Kerk IDEA Drive Interface Program (Program Mode)

File Edit Realtime Input Configuration Drive Commands Programs On Drive Encoder Help **Haydon kerk**

Motion: Extend, Retract, Move To, Go At Speed, Stop, E-Stop

Program Flow: Jump N Times, Goto, Goto If, Return, Return To, Goto Sub, Wait, Wait For Move, Int on Pos

Other: Set Outputs, Set Position, Reset, Abort, Comment

Action	Label	Description	Comment
0	Start	Extend 0.4 in	
1		Wait For Move	
2		Wait 1 sec	
3		Retract 0.2 in	
4		Wait For Move	
5		Wait 1 sec	
6		Extend 0.6 in	
7		Wait For Move	
8		Wait 1 sec	
9		Retract 0.8 in	
10		Wait For Move	
11		Wait 1 sec	
12		Goto Start	

Program Edit: Program Name:

Run Control: Program To Run:

I/O and Position: Current Position: 0.000 in

Inputs: 1 2 3 4 (all green)

Outputs: 1 2 3 4 (all white)

Program Length: 240 bytes / 1 pages

Ready...

**Example Two:** This example will extend the actuator .5”, retract the actuator .5”, then repeat those two moves 4 more times. Once the repetitions are complete, the actuator will extend 1”. Let the linear speed for each move be 1 inch per second.

We first want to extend 0.5”.

- Click the “Extend” button.
- Input the distance as 0.5 inches.
- Input the speed as 1 inch per second.
- All other parameters can be left as the defaults.
- Enter “Start” as the label.
- You can add a comment in the comment line if you wish.
- Click the “Add At End” button. This places the command in program.

Note: You will notice that when the extend command populates in the program field on the screen, that it is followed by a second command that states “Wait For Move“. This is also true when using the Retract and Move To commands. This is a command to allow the move to finish before execution of the next command.

We now want to retract 0.5”.

- Click the “Retract” button.
- Input the distance as 0.5 inches
- Input the speed as 1 inch per second
- No Label is required.
- You can add a comment in the comment line if you wish.
- Click the “Add At End” button. This places the command in program.

We now want to repeat the first two moves four times.

- Click the “Jump N Times” button.

- Enter the destination as “Start”
- Enter the number of jumps as 4.
- Click “Add At End”. This places this command into the program.

We now want to extend 1”.

- Click the “Extend” button.
- Input the distance as 1”.
- Input the speed as 1 inch per second.
- All other parameters can be left as the defaults.
- No Label is required
- You can add a comment in the comment line if you wish.
- Click the “Add At End” button. This places the command in program.

The completed program looks as follows:

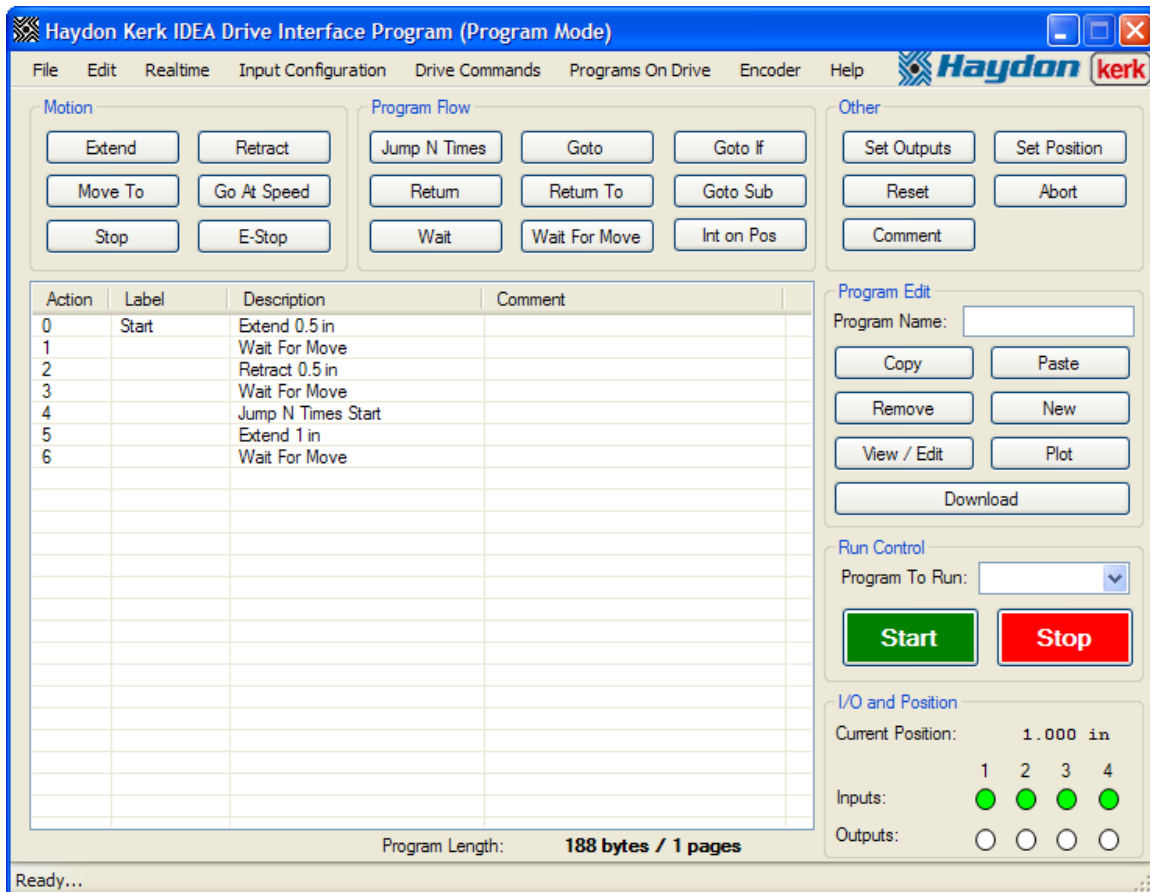

**Example Three:** This example will extend the actuator .5”, turn all four outputs high, wait .5 seconds, turn all outputs low, retract the actuator .5”, turn all four outputs high, wait .5 seconds, turn all outputs low, then end the program. We will accomplish this by using a subroutine.

We first want to extend 0.5”.

- Click the “Extend” button.
- Input the distance as 0.5 inches.
- Input the speed as 1 inch per second.
- All other parameters can be left as the defaults.
- No Label is required.
- You can add a comment in the comment line if you wish.
- Click the “Add At End” button. This places the command in program.

Note: You will notice that when the extend command populates in the program field on the screen, that it is followed by a second command that states “Wait For Move“. This is also true when using the Retract and Move To commands. This is a command to allow the move to finish before execution of the next command.

We now want to use a subroutine to toggle the outputs on and off.

- Click the “Goto Sub” button.
- Enter the destination as “Toggle”
- No label is required.
- You can add a comment in the comment line if you wish.
- Click the “Add At End” button. This places the command in program.

We now want to retract 0.5”.

- Click the “Retract” button.
- Input the distance as 0.5 inches
- Input the speed as 1 inch per second

- No Label is required.
- You can add a comment in the comment line if you wish.
- Click the “Add At End” button. This places the command in program.

We now want to use a subroutine to toggle the outputs on and off.

- Click the “Goto Sub” button.
- Enter the destination as “Toggle”
- No label is required.
- You can add a comment in the comment line if you wish.
- Click the “Add At End” button. This places the command in program.

We now want to stop the program.

- Click the “Abort” button.
- Input the distance as 1”.
- Input the speed as 1 inch per second.
- All other parameters can be left as the defaults.
- No Label is required
- You can add a comment in the comment line if you wish.
- Click the “Add At End” button. This places the command in program.

Now we have the main body of the program, but we still need the “Toggle” subroutine.

- Click the “Set Outputs” button.
- Select “High” for each of the four outputs.
- Enter “Toggle” as the label
- You can add a comment in the comment line if you wish.
- Click the “Add At End” button. This places the command in program.

Now we need to wait 0.1 seconds.

- Click the “Wait” button.

- Enter 0.5 seconds as the delay time
- No Label is required.
- You can add a comment in the comment line if you wish.
- Click the “Add At End” button. This places the command in program.

Now we need to set the outputs low.

- Click the “Set Outputs” button.
- Select “Low” for each of the four outputs.
- No label is required.
- You can add a comment in the comment line if you wish.
- Click the “Add At End” button. This places the command in program.

Now we need to return to the main body of the program. To go back to where the subroutine was called from, we use a “Return” command.

- Click the “Return” button.
- No label is required.
- You can add a comment in the comment line if you wish.
- Click the “Add At End” button. This places the command in program.

The completed program looks as follows:



Haydon Kerk IDEA Drive Interface Program (Program Mode)

File Edit Realtime Input Configuration Drive Commands Programs On Drive Encoder Help **Haydon kerk**

**Motion**

Extend Retract  
Move To Go At Speed  
Stop E-Stop

**Program Flow**

Jump N Times Goto Goto If  
Return Return To Goto Sub  
Wait Wait For Move Int on Pos

**Other**

Set Outputs Set Position  
Reset Abort  
Comment

Action	Label	Description	Comment
0		Extend 0.5 in	
1		Wait For Move	
2		Goto Sub Toggle	
3		Retract 0.5 in	
4		Wait For Move	
5		Goto Sub Toggle	
6		Abort	
7	Toggle	Set Outputs H H H H	
8		Wait 0.5 sec	
9		Set Outputs L L L L	
10		Return	

**Program Edit**

Program Name: example3

Copy Paste  
Remove New  
View / Edit Plot  
Download

**Run Control**

Program To Run: example3

**Start** **Stop**

**I/O and Position**

Current Position: 0.000 in

Inputs: 1 2 3 4

Outputs:

Program Length: **168 bytes / 1 pages**

Ready...

**Example Four:** This example is different in that the actuator does not need to start in the fully retracted position. We will perform a homing routine, to find the fully retracted position, and then move to 0.5” from that point, wait 1 second, and then return to the fully retracted position.

We first want to retract the full stroke of the actuator.

- Click the “Retract” button.
- Input the distance as 1 inch.
- Input the speed as 0.5 inch per second.
- Select “1/4” as the step mode.
- All other parameters can be left as the defaults.
- No Label is required.
- You can add a comment in the comment line if you wish.
- Click the “Add At End” button. This places the command in program.

Note: You will notice that when the retract command populates in the program field on the screen, that it is followed by a second command that states “Wait For Move“. This is also true when using the Extend and Move To commands. This is a command to allow the move to finish before execution of the next command.

We are now at the fully retracted position; to keep track of this we will use the “Set Position” command.

- Click the “Set Position” button.
- Enter a position of 0”.
- No Label is required.
- You can add a comment in the comment line if you wish.
- Click “Add At End”. This places this command into the program.

We now want to move to the 0.5” position.

- Click the “Move To” button.
- Enter a position of 0.5”.
- Enter a speed of 1” per second.
- No Label is required.
- You can add a comment in the comment line if you wish.
- Click the “Add At End” button. This places the command in program.

We now want to wait 1 second.

- Click the “Wait” button.
- Enter a delay time of 1 second.
- No Label is required.
- You can add a comment in the comment line if you wish.
- Click “Add At End”. This places this command into the program.

We now want to move back to the 0” position.

- Click the “Move To” button.
- Enter a position of 0”.
- All other parameters are populated.
- No Label is required.
- You can add a comment in the comment line if you wish.
- Click the “Add At End” button. This places the command in program.

The completed program looks as follows:

Haydon Kerk IDEA Drive Interface Program (Program Mode)

File Edit Realtime Input Configuration Drive Commands Programs On Drive Encoder Help 

**Motion**

Extend Retract  
Move To Go At Speed  
Stop E-Stop

**Program Flow**

Jump N Times Goto Goto If  
Return Return To Goto Sub  
Wait Wait For Move Int on Pos

**Other**

Set Outputs Set Position  
Reset Abort  
Comment

Action	Label	Description	Comment
0		Retract 1 in	
1		Wait For Move	
2		Set Position 0 in	
3		Move To 0.5 in	
4		Wait For Move	
5		Wait 1 sec	
6		Move To 0 in	
7		Wait For Move	

**Program Edit**

Program Name:

Copy Paste  
Remove New  
View / Edit Plot  
Download

**Run Control**

Program To Run:

**Start** **Stop**

**I/O and Position**

Current Position: 0.000 in

Inputs: 1 2 3 4  
● ● ● ●

Outputs: ○ ○ ○ ○

Program Length: 184 bytes / 1 pages

Ready...

**Example Five:** In this example, we will first find the fully retracted position of the actuator, then the actuator will move to the 0" position if input 1 is high and input 2 is low, move to the 1" position if input 1 is low and input 2 is high, or stop if inputs 1 and 2 are both high, or both low.

We first want to retract the full stroke of the actuator.

- Click the "Retract" button.
- Input the distance as 1".
- Input the speed as 0.5 inch per second.
- Select "1/4" as the step mode.
- All other parameters can be left as the defaults.
- No Label is required.
- You can add a comment in the comment line if you wish.
- Click the "Add At End" button. This places the command in program.

Note: You will notice that when the retract command populates in the program field on the screen, that it is followed by a second command that states "Wait For Move". This is also true when using the Extend and Move To commands. This is a command to allow the move to finish before execution of the next command.

We are now at the fully retracted position; to keep track of this we will use the "Set Position" command.

- Click the "Set Position" button.
- Enter a position of 0".
- No Label is required.
- You can add a comment in the comment line if you wish.
- Click "Add At End". This places this command into the program.

We now move based on the input status. Set up the first "Goto If"

- Click the "Goto If" button.

- Enter “Retract” as the destination.
- Set Input 1 is “High”
- Set Input 2 as “Low”
- Set Inputs 3 and 4 as “Not Tested”
- Enter “Test” as the label.
- You can add a comment in the comment line if you wish.
- Click the “Add At End” button. This places the command in program.

Set up the second “Goto If”

- Click the “Goto If” button.
- Enter “Extend” as the destination.
- Set Input 1 is “Low”
- Set Input 2 as “High”
- Set Inputs 3 and 4 as “Not Tested”
- No Label is required.
- You can add a comment in the comment line if you wish.
- Click the “Add At End” button. This places the command in program.

If we reach this line, then either both inputs are high, or both inputs are low. So we want to stop the actuator.

- Click the “Stop” button.
- All parameters can be left at the defaults.
- No Label is required.
- You can add a comment in the comment line if you wish.
- Click the “Add At End” button. This places the command in program.

We now want to check if the input conditions have changed, so we go back to the Goto Ifs.

- Click the “Goto” button.
- Enter “Test” as the destination.

- No Label is required.
- You can add a comment in the comment line if you wish.
- Click the “Add At End” button. This places the command in program.

We now need the commands that will be used to move the actuator. We will start with the “Retract” move.

- Click the “Move To” button.
- Enter a position of 0”.
- Enter “Retract” as the label.
- You can add a comment in the comment line if you wish.
- Click “Add At End”. This places this command into the program.

We now want to check if the input conditions have changed, so we go back to the Goto ifs. We don’t want the move to finish before we check the inputs again, so we will remove the “Wait For Move” command.

- Click the line that holds the “Wait For Move” command
- Click the “Remove” button
- Click “Yes” to confirm the removal of the command.
- Click the “Goto” button.
- Enter “Test” as the destination.
- No Label is required.
- You can add a comment in the comment line if you wish.
- Click the “Add At End” button. This places the command in program.

We will next add the “Extend” move.

- Click the “Move To” button.
- Enter a position of 1”.
- Enter “Extend” as the label.
- You can add a comment in the comment line if you wish.

- Click “Add At End”. This places this command into the program.

We now want to check if the input conditions have changed, so we go back to the Goto lfs. We don't want the move to finish before we check the inputs again, so we will remove the “Wait For Move” command.

- Click the line that holds the “Wait For Move” command
- Click the “Remove” button
- Click “Yes” to confirm the removal of the command.
- Click the “Goto” button.
- Enter “Test” as the destination.
- No Label is required.
- You can add a comment in the comment line if you wish.
- Click the “Add At End” button. This places the command in program.

The completed program looks as follows:





**Example Six:** In this example, we will first find the fully retracted position of the actuator. The actuator will continuously move in the extend direction, until getting 0.9” from the fully retracted position. When the 0.9” position is reached, the actuator will retract back to the 0” position, and resume the extend. If at any time during the program, input 1 changes state, the program will abort.

We first need to set up the interrupt triggered by the input.

- Click the “Int on Input” Button.
- Select “Enabled” for Input 1 Interrupt
- Enter “Abort” as the destination.
- Select “Both Edges” as the trigger type.
- Select “0-Highest” as the priority.
- Click the “Add At End” button. This places the command in program.

We now want to retract the full stroke of the actuator.

- Click the “Retract” button.
- Input the distance as 1”.
- Input the speed as 0.5 inch per second.
- Select “1/4” as the step mode.
- All other parameters can be left as the defaults.
- No Label is required.
- You can add a comment in the comment line if you wish.
- Click the “Add At End” button. This places the command in program.

Note: You will notice that when the retract command populates in the program field on the screen, that it is followed by a second command that states “Wait For Move”. This is also true when using the Extend and Move To commands. This is a command to allow the move to finish before execution of the next command.

We are now at the fully retracted position; to keep track of this we will use the “Set Position” command.

- Click the “Set Position” button.
- Enter a position of 0”.
- No Label is required.
- You can add a comment in the comment line if you wish.
- Click “Add At End”. This places this command into the program.

In order to force the actuator to go back to the 0” position when the 0.9” position is reached, we will use an interrupt based on position.

- Click the “Int On Pos” button.
- Enter a position of 0.9”.
- Enter “Retract” as the destination.
- Select “1” as priority.
- No Label is required.
- You can add a comment in the comment line if you wish.
- Click “Add At End”. This places this command into the program.

We now want to begin moving.

- Click the “Go at Speed” button.
- Select “Extend” as the direction
- Enter 1” per second as the speed.
- Enter “Extend” as the label.
- You can add a comment in the comment line if you wish.
- Click the “Add At End” button. This places the command in program.

We now want to continuously loop onto the “Go At Speed” command.

- Click the “Goto” button.
- Enter “Extend” as the destination.

- No Label is required.
- You can add a comment in the comment line if you wish.
- Click the “Add At End” button. This places the command in program.

We now need the interrupt subroutines. We will start with the interrupt subroutine for the interrupt based on position.

- Click the “Move To” button.
- Enter a position of 0”.
- Enter a speed of 1” per second.
- Enter “Retract” as the label.
- You can add a comment in the comment line if you wish.
- Click the “Add At End” button. This places the command in program.

We now need to exit the subroutine.

- Click the “Return To” button.
- Enter “Extend” as the destination.
- No Label is required.
- You can add a comment in the comment line if you wish.
- Click the “Add At End” button. This places the command in program.

We now need a subroutine for the interrupt based on the input.

- Click the “Abort” button.
- Enter “Abort” as the label.
- You can add a comment in the comment line if you wish.
- Click “Add At End”. This places this command into the program.

The completed program looks as follows:

Haydon Kerk IDEA Drive Interface Program (Program Mode)

File Edit Realtime Drive Commands Programs On Drive Help

**Motion**

Extend Stop  
Retract E-Stop  
Move To  
Go At Speed

**Program Flow**

Goto Return Int on Pos  
Goto If Return To Int on Input  
Jump N Times Wait  
Goto Sub Wait For Move

**Other**

Set Outputs Set Position  
Reset Abort  
Encoder  
Comment

Action	Label	Description	Comment
0		Int on Input INT, GP, GP, GP	
1		Retract 1 in	
2		Wait For Move	
3		Set Position 0 in	
4		Int On Position 0.9 in	
5	Extend	Go At Speed 1 in/sec	
6		Goto Extend	
7	Retract	Move To 0 in	
8		Wait For Move	
9		Return To Extend	
10	Abort	Abort	

**Program Edit**

Program Name:

Copy Paste  
Remove New  
View / Edit Plot  
Download

**Run Control**

Program To Run:

**Start** **Stop**

**I/O and Position**

Current Position: **0.000 in**

Inputs: 1 2 3 4

Outputs:

Program Length: **224 bytes / 1 pages**

Ready...

## The IDEA drive menu items:

- **File:** This menu gives access to functions for manipulation of program files and the User interface itself.
  1. **New:** Clears the current program so a new program can be written.
  2. **Open:** Opens a previously saved program file.
  3. **Save:** Saves the current program to a file.
  4. **Add File:** Adds a previously saved program file to the end of the current program.
  5. **Recover Autosave:** Opens the most recently autosaved file.
  6. **Print:** Prints the current program
  7. **Restart:** Exits the user interface and opens a new user interface.
  8. **Exit:** Closes the user interface.
  
- **Edit:** This menu gives access to functions for manipulating the current program.
  1. **Undo:** Restores the program to what it was before the last action.
  2. **Redo:** Restores the program to what it was before an undo.
  3. **Cut:** Removes a selected line or lines from the program and copies them to be pasted later.
  4. **Copy:** Copies a selected line or lines to be pasted later.
  5. **Paste:** Inserts previously copied lines into a program.
  6. **Select all:** Selects all lines of the program.
  
- **Mode:** The third menu item toggles between the Realtime Mode and Program Mode.
  
- **Drive Commands:** This menu allows access to various drive functions.

1. **Display Table of Contents:** Gives a listing of the programs on the drive and their page locations. Also provides a graphical representation of the used space in the drive.
  2. **Set Startup Program:** Used to choose what program, if any, should begin execution when the drive starts up.
  3. **Delete Program:** Used to remove programs from the drive.
  4. **Input Simulation:** This item toggles the drive between using the true input status, or the simulated status through the user interface
  5. **Set Drive Address:** Used to change the address of the current drive.
  6. **Set/Change Password:** Used to configure the password of the drive.
  7. **Restore Factory Defaults:** Removes password protection from the drive, and removes all programs on the drive.
  8. **Firmware Version:** Used to find the firmware version of the drive.
  9. **Update Firmware:** Used to reprogram the drive with the firmware version that was most recent when the user interface was installed.
- **Communications Mode:** Opens the communications mode dialog box. This allows for switching between the for communications modes.
  - **Programs on Drive:** Shows a list of the programs that are on the drive. Clicking on a program loads that program to the program area. The startup program, if one exists, appears in bold on this list.
  - **Help:** Allows access to functions to help with the use of the user interface and drive.
    1. **About:** Displays a brief description of Haydon Kerk and its products.
    2. **User's Manual:** Displays this manual.
    3. **Communications Manual:** Opens the communications manual.

## **Glossary:**

**Abort:** Stops movement of the actuator with holding current and ends any running program.

**Accel Boost:** When set to “Yes”, the move profile will include a 30% increase in RMS current per phase during the beginning of the acceleration ramp.

**Accel Rate:** The acceleration rate to be used with a move.

**Clear:** Clear the entire program from the program screen

**Comment:** Allows the user to insert comments within the program

**Copy:** Allows the user to copy a given program line or lines and insert them elsewhere in the program

**Current position box:** Indicates the current position of the motor

**Decel Boost:** When set to “Yes”, the move profile will include a 30% increase in RMS current per phase during the end of the deceleration ramp.

**Decel Rate:** The deceleration rate to be used with a move.

**Delay Time (in reference to a move):** The time between when the last step in a move profile is taken, and when the current is set to the hold current.

**Delay Time (in reference to a “Wait” command):** The amount of time that the wait command should delay execution of the next command.

**Destination:** The address to which the program should branch.

**Distance:** How far a move should go.

**Download:** Allows the program to be downloaded into drive

**E-Stop:** Abruptly stops the actuator without any deceleration

**Encoder:** A feedback device that converts position data to an electronic signal that the drive keeps track of.

**End Speed:** The speed at the end of a move profile; determines the time between the last and second to last step.

**Extend:** Extends the actuator shaft forward. The user inputs the distance and speed. Items such as run current and hold current are auto populated based on the part number of the actuator. These values can be overridden provided the inserted value does not exceed the devices limitations.

**Go at Speed:** Extends or retracts the actuator at a given speed.



**Goto:** Branching statement for programming. Branches to a destination label.

**Goto if:** Branching statement for programming. Branches to a destination label if the input conditions are met.

**Goto Sub:** Branching statement for programming that navigates the program to a subroutine.

**Hold Current:** The RMS current per phase that should be applied to the motor windings when the motor is at a standstill.

**I/O box:** Displays the state of each general purpose I/O.

**Int on Input:** Interrupt on Input. This is an interrupt that occurs when an input changes state.

**Int on Pos:** Interrupt on Position. This is an interrupt that occurs when the actuator reaches a specific position.

**Interrupt:** An asynchronous event that causes the execution of a subroutine.

**Jump N times:** Allows the program to jump N times to a specified label

**Label:** A string that identifies a command. Used to branch to the command.

**Move to:** Moves the actuator to a specified position.

**Paste:** Used in conjunction with the copy or cut functions. After one or more commands are selected, another location in the program is then highlighted by the user. The paste button is then pressed and the line or lines are inserted above the highlighted line.

**Plot:** Any move can be shown as a plot of speed vs time. Highlight the move command of interest then press the plot button.

**Position:** A location based upon the drive's internal position counter, or encoder counter, when enabled.

**Priority:** The determining factor in which interrupts are serviced first.

**Program name box:** This is the location on the screen where the name of the program is inputted by the user. The program is stored in the drive under this name.

**Program to run box:** This is a drop down menu that lists the programs stored on the drive. Double clicking on a given name populates the program into the program screen and creates that program as the active program in the drive.

**Remove:** This is used to remove one or more lines from a program. Highlight the lines to be removed. Then click the remove button.

**Reset:** This command simulates turning the drive off and on again.

**Retract:** Retracts the actuator shaft. The user inputs the distance and speed. Items such as run current and hold current are auto populated based on the part number of the actuator. These values can be overridden provided the inserted value does not exceed the device's limitations.

**Return:** Used in conjunction with the goto sub command or interrupts. At the end of a subroutine the "return" command returns to the program to the very next line after the Goto sub line command, or the command that was going to be executed before the interrupt was triggered.

**Return to:** Used in conjunction with the goto sub command or interrupts. At the end of a subroutine the "return to" command returns to the command at a specified label location.

**Run Current:** The RMS current per phase to be applied to the motor windings during a move.

**Set outputs:** Allow the programmer to set general purpose outputs.

**Set position:** Used to change the current position. Using this command the position counter can be adjusted, usually after a homing routine. Then other commands such as "move to" or "interrupt on position" can be used in relationship with this set position.

**Speed:** The desired top speed for a move.

**Start (Large green button):** Starts running a program.

**Start Speed:** The speed that a move profile should start at; determines the time between the first and second step.

**Step Mode:** Sets how many microsteps are taken for each full step of the motor.

**Stop:** Stops the movement of the actuator with a specified deceleration

**Stop (Large red button):** Immediately stops the motor and program when pressed.

**Subroutine:** A section of code used that is entered by using an interrupts, or the “Goto Sub” command. Subroutines must end with a “Return” or “Return To” command.

**View / Edit:** After highlighting a specific line in a program, the “View / Edit” button can be pressed causing the details for that line to display. These details can then be modified and updated.

**Wait:** Allows the programmer to put in a time specific time delay.

**Wait for move:** Delays execution of the next line of the program until the motor has come to a stop.