

DIGITAL VIDEO RECORDER 4- AND 8-CHANNEL MODELS USER'S MANUAL

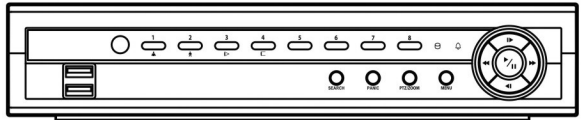



WARNING
RISK OF ELECTRIC SHOCK
DO NOT OPEN



WARNING: TO REDUCE THE RISK OF ELECTRIC SHOCK,
DO NOT REMOVE COVER (OR BACK).
NO USER-SERVICEABLE PARTS INSIDE.
REFER SERVICING TO QUALIFIED
SERVICE PERSONNEL.



The lightning flash with arrowhead symbol, within an equilateral triangle, is intended to alert the user to the presence of uninsulated "dangerous voltage" within the product's enclosure that may be of sufficient magnitude to constitute a risk of electric shock.



The exclamation point within an equilateral triangle is intended to alert the user to the presence of important operating and maintenance (servicing) instructions in the literature accompanying the appliance.

COMPLIANCE NOTICE OF FCC:

THIS EQUIPMENT HAS BEEN TESTED AND FOUND TO COMPLY WITH THE LIMITS FOR A CLASS A DIGITAL DEVICE, PURSUANT TO PART 15 OF THE FCC RULES. THESE LIMITS ARE DESIGNED TO PROVIDE REASONABLE PROTECTION AGAINST HARMFUL INTERFERENCE WHEN THE EQUIPMENT IS OPERATED IN A COMMERCIAL ENVIRONMENT. THIS EQUIPMENT GENERATES, USES, AND CAN RADIATE RADIO FREQUENCY ENERGY AND IF NOT INSTALLED AND USED IN ACCORDANCE WITH THE INSTRUCTION MANUAL, MAY CAUSE HARMFUL INTERFERENCE TO RADIO COMMUNICATIONS. OPERATION OF THIS EQUIPMENT IN A RESIDENTIAL AREA IS LIKELY TO CAUSE HARMFUL INTERFERENCE, IN WHICH CASE USERS WILL BE REQUIRED TO CORRECT THE INTERFERENCE AT THEIR OWN EXPENSE.

WARNING: CHANGES OR MODIFICATIONS NOT EXPRESSLY APPROVED BY THE PARTY RESPONSIBLE FOR COMPLIANCE COULD VOID THE USER'S AUTHORITY TO OPERATE THE EQUIPMENT.

THIS CLASS OF DIGITAL APPARATUS MEETS ALL REQUIREMENTS OF THE CANADIAN INTERFERENCE-CAUSING EQUIPMENT REGULATIONS.

The software included in this product contains some Open Sources. You may obtain the complete corresponding source code from us. See the Open Source Guide on the software CD (*OpenSourceGuide\OpenSourceGuide.pdf*) or as a printed document included along with the User's Manual.

The information in this manual is believed to be accurate as of the date of publication. We are not responsible for any problems resulting from the use thereof. The information contained herein is subject to change without notice. Revisions or new editions to this publication may be issued to incorporate such changes.

Important Safeguards

<p>1. Read Instructions All the safety and operating instructions should be read before the appliance is operated.</p> <p>2. Retain Instructions The safety and operating instructions should be retained for future reference.</p> <p>3. Cleaning Unplug this equipment from the wall outlet before cleaning it. Do not use liquid aerosol cleaners. Use a damp soft cloth for cleaning.</p> <p>4. Attachments Never add any attachments and/or equipment without the approval of the manufacturer as such additions may result in the risk of fire, electric shock or other personal injury.</p> <p>5. Water and/or Moisture Do not use this equipment near water or in contact with water.</p> <p>6. Accessories Do not place this equipment on an unstable cart, stand or table. The equipment may fall, causing serious injury to a child or adult, and serious damage to the equipment. Wall or shelf mounting should follow the manufacturer's instructions, and should use a mounting kit approved by the manufacturer.</p> <div style="text-align: center; margin: 10px 0;">  </div> <p>This equipment and cart combination should be moved with care. Quick stops, excessive force, and uneven surfaces may cause the equipment and cart combination to overturn.</p> <p>7. Power Sources This equipment should be operated only from the type of power source indicated on the marking label. If you are not sure of the type of power, please consult your equipment dealer or local power company.</p> <p>8. Power Cords Operator or installer must remove power and TNT connections before handling the equipment.</p> <p>9. Lightning For added protection for this equipment during a lightning storm, or when it is left unattended and unused for long periods of time, unplug it from the wall outlet and disconnect the antenna or cable system. This will prevent damage to the equipment due to lightning and power-line surges.</p> <p>10. Overloading Do not overload wall outlets and extension cords as this can result in the risk of fire or electric shock.</p> <p>11. Objects and Liquids Never push objects of any kind through openings of this equipment as they may touch dangerous voltage points or short out parts that could result in a fire or electric shock. Never spill liquid of any kind on the equipment.</p> <p>12. Servicing Do not attempt to service this equipment yourself. Refer all servicing to qualified service personnel.</p>	<p>13. Damage requiring Service Unplug this equipment from the wall outlet and refer servicing to qualified service personnel under the following conditions:</p> <p>A. When the power-supply cord or the plug has been damaged. B. If liquid is spilled, or objects have fallen into the equipment. C. If the equipment has been exposed to rain or water. D. If the equipment does not operate normally by following the operating instructions, adjust only those controls that are covered by the operating instructions as an improper adjustment of other controls may result in damage and will often require extensive work by a qualified technician to restore the equipment to its normal operation. E. If the equipment has been dropped, or the cabinet damaged. F. When the equipment exhibits a distinct change in performance — this indicates a need for service.</p> <p>14. Replacement Parts When replacement parts are required, be sure the service technician has used replacement parts specified by the manufacturer or that have the same characteristics as the original part. Unauthorized substitutions may result in fire, electric shock or other hazards.</p> <p>15. Safety Check Upon completion of any service or repairs to this equipment, ask the service technician to perform safety checks to determine that the equipment is in proper operating condition.</p> <p>16. Field Installation This installation should be made by a qualified service person and should conform to all local codes.</p> <p>17. Correct Batteries Warning: Risk of explosion if battery is replaced by an incorrect type. Dispose of used batteries according to the instructions.</p> <p>18. Tmra A manufacturer's maximum recommended ambient temperature (Tmra) for the equipment must be specified so that the customer and installer may determine a suitable maximum operating environment for the equipment.</p> <p>19. Elevated Operating Ambient Temperature If installed in a closed or multi-unit rack assembly, the operating ambient temperature of the rack environment may be greater than room ambient. Therefore, consideration should be given to installing the equipment in an environment compatible with the manufacturer's maximum rated ambient temperature (Tmra).</p> <p>20. Reduced Air Flow Installation of the equipment in the rack should be such that the amount of airflow required for safe operation of the equipment is not compromised.</p> <p>21. Mechanical Loading Mounting of the equipment in the rack should be such that a hazardous condition is not caused by uneven mechanical loading.</p> <p>22. Circuit Overloading Consideration should be given to connection of the equipment to supply circuit and the effect that overloading of circuits might have on over current protection and supply wiring. Appropriate consideration of equipment nameplate ratings should be used when addressing this concern.</p> <p>23. Reliable Earthing (Grounding) Reliable grounding of rack mounted equipment should be maintained. Particular attention should be given to supply connections other than direct connections to the branch circuit (e.g., use of power strips).</p>
--	---

WEEE (Waste Electrical & Electronic Equipment)

Correct Disposal of This Product

(Applicable in the European Union and other European countries with separate collection systems)



This marking shown on the product or its literature, indicates that it should not be disposed with other household wastes at the end of its working life. To prevent possible harm to the environment or human health from uncontrolled waste disposal, please separate this from other types of wastes and recycle it responsibly to promote the sustainable reuse of material resources.

Household users should contact either the retailer where they purchased this product, or their local government office, for details of where and how they can take this item for environmentally safe recycling.

Business users should contact their supplier and check the terms and conditions of the purchase contract. This product should not be mixed with other commercial wastes for disposal.

Table of Contents

Chapter 1 – Introduction	1
Features	1
Technical Overview	1
Chapter 2 – Installation	3
Package Contents	3
Required Installation Tools	3
Video Input	3
Audio In/Out	4
Factory Reset Switch	4
Video Out	4
Network Port.....	4
Alarm Input/Output	5
RS485 Port.....	5
RS232 Port.....	5
Power Cord Connector.....	6
Chapter 3 – Configuration.....	7
Front Panel Controls	7
Camera Buttons (1 to 8).....	7
HDD LED.....	8
Alarm LED	8
Arrow Buttons.....	8
Play/Pause Button.....	8
Menu Button	8
PTZ/Zoom Button	8
Panic Button	9
Search Button.....	9
USB Port	9
Remote Control Buttons	10
ID Button	10
Camera Buttons	10
Sequence Button.....	10
Freeze Button.....	10
Arrow Buttons.....	11
Menu Button	11
Playback Buttons.....	11
Panic Button	11
Layout Button	11
Zoom Button.....	11
PTZ Button	12
Enter Button	12
Alarm Button.....	12
PTZ Control Buttons.....	12

Back Up Button	12
Calendar Button	12
Turning on the Power	12
Initial Unit Setup	12
Setup Screen.....	13
System Setup	14
Information	14
Date/Time.....	16
Storage.....	18
Wizard	19
User.....	23
Shutdown	25
Network Setup.....	25
Network	25
Notification.....	30
Devices Setup	31
Camera.....	32
Audio	33
Alarm-Out.....	33
Display.....	34
Remote Control	36
Recording Setup.....	37
Record.....	37
Schedule	38
Pre-Event	41
Event Setup.....	41
Alarm-In.....	41
Motion Detection	43
Video Loss.....	45
Video Blind	47
Text-In	48
System Event	50
Event Status.....	52
Chapter 4 – Operation	55
Turning on the Power	55
Live Monitoring.....	55
Live Monitoring Menu	56
Active Cameo Mode	57
Zoom Mode	58
Event Monitoring	58
Covert Camera	58
PTZ Mode.....	59
Using a Mouse	60
Recording Video.....	61
Recording Audio.....	62

Playing Recorded Video	62
Searching Video	63
Search Menu	63
Event Log Search	65
Record Table Search	67
Motion Search	68
Text-In Search	70
Clip-Copy	71
Appendix	73
USB Hard Disk Drive Preparation	73
Preparing the USB hard disk drive in Windows 2000	73
Preparing the USB hard disk drive in Windows 98	73
Text-In Search Examples	74
Search Example I	74
Search Example II	75
WebGuard	75
Web Monitoring Mode	77
Web Search Mode	78
System Log Notices	80
Error Code Notices	81
Troubleshooting	81
Map of Screens	82
Specifications	83

List of Illustrations

Figure 1 – Typical DVR installation	2
Figure 2 – 8-Channel DVR rear panel	3
Figure 3 – 8-Channel DVR front panel	7
Figure 4 – Infrared remote control	10
Figure 5 – Login screen	13
Figure 6 – Logout screen	13
Figure 7 – Setup screen	13
Figure 8 – System menu	14
Figure 9 – Information setup screen	14
Figure 10 – Date/Time setup screen	16
Figure 11 – Holiday setup screen	17
Figure 12 – Time Sync. setup screen	17
Figure 13 – Storage Information setup screen	18
Figure 14 – Storage Status setup screen	19
Figure 15 – Setup wizard screen	19
Figure 16 – Quick Setup Wizard screen	20
Figure 17 – Network Setup Wizard screen	21
Figure 18 – User setup screen	23

Figure 19 – Shutdown screen.....	25
Figure 20 – Network menu.....	25
Figure 21 – Network setup screen.....	25
Figure 22 – LAN (Manual) setup screen.....	26
Figure 23 – DVRNS setup screen.....	28
Figure 24 – RTSP setup screen.....	29
Figure 25 – WebGuard setup screen.....	30
Figure 26 – Notification Mail setup screen.....	30
Figure 27 – Notification Callback setup screen.....	31
Figure 28 – Devices menu.....	31
Figure 29 – Camera setup screen.....	32
Figure 30 – Camera PTZ setup screen.....	32
Figure 31 – Audio setup screen.....	33
Figure 32 – Alarm-Out Settings setup screen.....	33
Figure 33 – Alarm-Out Schedule setup screen.....	34
Figure 34 – Display OSD setup screen.....	34
Figure 35 – Main Monitor setup screen.....	35
Figure 36 – VGA setup screen.....	36
Figure 37 – Remote Control setup screen.....	36
Figure 38 – Record menu.....	37
Figure 39 – Record setup screen.....	37
Figure 40 – Record setup screen.....	38
Figure 41 – Schedule setup screen.....	39
Figure 42 – Schedule – Settings (Advanced Mode) setup screen.....	40
Figure 43 – Pre-Event setup screen.....	41
Figure 44 – Event menu.....	41
Figure 45 – Alarm-In Settings setup screen.....	42
Figure 46 – Alarm-In Actions setup screen.....	42
Figure 47 – Motion Detection Settings setup screen.....	43
Figure 48 – Motion Detection Actions setup screen.....	45
Figure 49 – Video Loss Settings setup screen.....	46
Figure 50 – Video Loss Actions setup screen.....	46
Figure 51 – Video Blind Settings setup screen.....	47
Figure 52 – Video Blind Actions setup screen.....	47
Figure 53 – Text-In Settings setup screen.....	48
Figure 54 – Text-In Device setup screen.....	48
Figure 55 – Text-In Actions setup screen.....	50
Figure 56 – Health Check setup screen.....	51
Figure 57 – Storage setup screen.....	51
Figure 58 – System Event Actions setup screen.....	52
Figure 59 – Event Status setup screen.....	53
Figure 60 – Live Monitoring menu.....	55
Figure 61 – PTZ Select Camera menu.....	59
Figure 62 – PTZ Preset screen.....	59
Figure 63 – Mouse Display menu.....	60
Figure 64 – Search menu.....	63
Figure 65 – Event Log Search screen.....	65
Figure 66 – Record Table Search screen.....	67
Figure 67 – Motion Search screen.....	68
Figure 68 – Text-In Search screen.....	70
Figure 69 – Clip-Copy screen.....	71

Chapter 1 – Introduction

Features

Your color digital video recorder (DVR) provides recording capabilities for four or eight camera inputs. It provides exceptional picture quality in both live and playback modes, and offers the following features:

- 4 or 8 Composite Video Input Connectors
- Compatible with Color (NTSC or PAL) and B&W (CCIR and EIA-170) Video Sources
- Auto Detection for NTSC and PAL
- Monitor Connectors: 1 BNC Video Out, 1 VGA
- H.264 Codec
- Multiple Search Engines (Date/Time, Record Table, Event)
- Records up to 240/200 Images per Second (NTSC/PAL)
- Continuous Recording in Disk Overwrite Mode
- 2 USB 2.0 Ports
- Continues Recording while Transmitting to Remote Site and during Playback
- User-friendly Graphical User Interface (GUI) Menu System
- Multiple Recording Modes (Time-lapse, Pre-event, Event and Panic)
- Two-way Audio Communication
- 4-Channel Audio Recording and 1-Channel Audio Playback
- Text Input for ATM and POS
- Alarm Connections Include: Input and Output
- Built-in Alarm Buzzer
- Live or Recorded Video Access via Ethernet
- Time Synchronization using industry standard protocol
- Self-diagnostics with automatic notification including hard disk drive S.M.A.R.T. protocol
- Infrared Remote Control

Technical Overview

In addition to replacing both a time-lapse VCR and a multiplexer in a security installation, your DVR has many features that make it much more powerful and easier to use than even the most advanced VCR.

The DVR converts analog NTSC or PAL video to digital images and records them on a hard disk drive. Using a hard disk drive allows you to access recorded video almost instantaneously; there is no need to rewind tape. The technology also allows you to view recorded video while the DVR continues recording video.

Digitally recorded video has several advantages over analog video recorded on tape. There is no need to adjust tracking. You can freeze frames, fast forward, fast reverse, slow forward and slow reverse without image streaking or tearing. Digital video can be indexed by time or events, and you can instantly view video after selecting the time or event.

Your DVR can be set up for event or time-lapse recording. You can define times to record, and the schedule can change for different days of the week and user defined holidays.

The DVR can be set up to alert you when the hard disk drive is full, or it can be set to record over the oldest video once the disk is full.

Your DVR uses a proprietary encryption scheme making it nearly impossible to alter video.

You can view video and control your DVR remotely by connecting via Ethernet. There is a USB port that can be used to upgrade the system or copy video clips to external hard disk and flash drives.

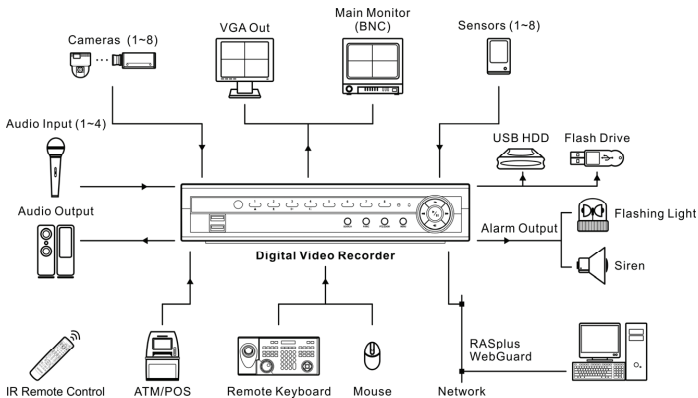

Figure 1 – Typical DVR installation.

NOTE: This manual covers the 4- and 8-channel digital video recorders. The DVRs are identical except for the number of cameras and alarms that can be connected and the number of cameras that can be displayed. For simplicity, the illustrations and descriptions in this manual refer to the 8-camera model.

Chapter 2 – Installation

Package Contents

The package contains the following:

- Digital Video Recorder
- Power Adaptor and Power Cord
- User's Manual (This Document)
- RAS Software CD and User's Manual
- Infrared Remote Control

Required Installation Tools

No special tools are required to install the DVR. Refer to the installation manuals for the other items that make up part of your system.

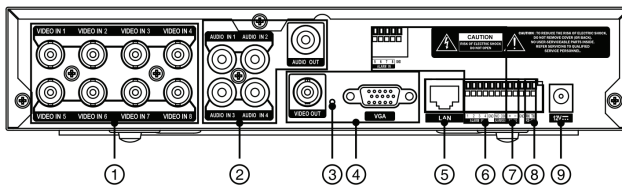

Figure 2 – 8-Channel DVR rear panel.

- | | | |
|---------------|----------------|------------------------|
| ① Video Input | ② Audio In/Out | ③ Factory Reset Switch |
| ④ Video Out | ⑤ Network Port | ⑥ Alarm Input/Output |
| ⑦ RS485 Port | ⑧ RS232 Port | ⑨ Power Cord Connector |

Your DVR can be used with either NTSC or PAL equipment.

NOTE: You cannot mix NTSC and PAL equipment. For example you cannot use a PAL camera and an NTSC monitor.

Video Input

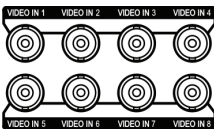

Connect the coaxial cables from the video sources to the BNC Video In connectors.

Audio In/Out

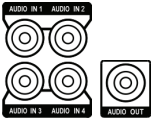

Your DVR can record audio from up to four sources. Connect the audio sources to Audio In 1, Audio In 2, Audio In 3 and Audio In 4 as needed using RCA jacks. Connect Audio Out to your amplifier.

NOTE: It is the user's responsibility to determine if local laws and regulations permit recording audio.

NOTE: The DVR does not have amplified audio output, so you will need a speaker with an amplifier. The DVR does not have a pre-amplifier for audio input, so the audio input should be from an amplified source, not directly from a microphone.

Factory Reset Switch



The DVR has a Factory Reset switch to the left of the VGA port on the rear panel. This switch will only be used on the rare occasions that you want to return all the settings to the original factory settings.

CAUTION: When using the *Factory Reset*, you will lose any settings you have saved.

To reset the unit, you will need a straightened paperclip:

1. Turn the DVR off.
2. Poke the straightened paperclip into the unlabeled hole to the left of the VGA port, and turn the DVR on.
3. Hold the reset switch until the DVR turns on and live monitoring screen appears.
4. Release the reset switch. All of the DVR's settings are now at the original settings it had when it left the factory.

Video Out



Connect the main monitor to the Video Out connector.



A VGA connector is provided so that you can use a standard, multi-sync computer monitor as your main monitor. Use the cable supplied with your monitor to connect it to the DVR.

NOTE: The *Video Out* (BNC) and *VGA* connectors may be connected to individual monitors for simultaneous operation.

Network Port



The DVR can be networked using the 10/100Mb Ethernet connector. Connect a Cat5 cable with an RJ-45 jack to the DVR connector. The DVR can be networked with a computer for remote monitoring, searching, configuration and software upgrades. See *Chapter 3 — Configuration* for configuring the Ethernet connections.

CAUTION: The network connector is not designed to be connected directly with cable or wire intended for outdoor use.

Alarm Input/Output



NOTE: To make connections on the Alarm Connector Strip, press and hold the button and insert the wire in the hole below the button. After releasing the button, tug gently on the wire to make certain it is connected. To disconnect a wire, press and hold the button above the wire and pull out the wire.

Alarm In 1 to 8 (Alarm-In): You can use external devices to signal the DVR to react to events. Mechanical or electrical switches can be wired to the AI (Alarm-In) and GND (Ground) connectors. The threshold voltage for NC (Normally Closed) is above 4.3V and for NO (Normally Open) is below 0.3V, and it should be stable at least 0.5 seconds to be detected. See *Chapter 3 — Configuration* for configuring alarm input.

GND (Ground): Connect the ground side of the Alarm input and/or alarm output to the GND connector.

NOTE: All the connectors marked GND are common.

NO (Normally Open): Connect the device to the COM and NO (Normally Open) connector. NO is a relay output which sinks 1A@30VDC.

Connector Pin Outs:

Alarm In (1 to 8)	Alarm Inputs 1 to 8
GND	Chassis Ground
COM	Common
NO	Alarm Out (Normally Open)

RS485 Port



The DVR can be controlled remotely by an external device or control system, such as a control keyboard, using RS485 half-duplex serial communications signals. The RS485 connector can also be used to control PTZ (pan, tilt, zoom) cameras or text-in devices. Connect RX+/TX+ and RX-/TX- of the control system to the + and - (respectively) of the DVR. See *Chapter 3 — Configuration* and the PTZ camera, text-in device or remote controller manufacture's manual for configuring the RS485 connection.

Connector Pin Outs:

Master Unit		Slave Unit	
+	→ To	→ TX+/RX+	
-	→ To	→ TX-/RX-	
GND	→ To	→ GND	

RS232 Port



An RS232 port is provided to connect the remote control devices such as a control keyboard. PTZ cameras or text-in devices can also be connected to the RS232 port. See *Chapter 3 — Configuration* and the PTZ camera, text-in device or remote controller manufacture's manual for configuring the RS232 connection.

Connector Pin Outs:

Master Unit		Slave Unit	
RX	→ To	→	TXD
TX	→ To	→	RXD
GND	→ To	→	GND

NOTE: Refer to the following 9-pin connector pin out of the slave unit.

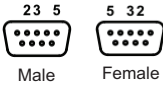

Pin 2	RXD (Receive Data)
Pin 3	XD (Transmit Data)
Pin 5	GND (Ground)

Power Cord Connector



Connect the connector of the adaptor to the DVR, and connect the AC power cord to the adaptor and then to the wall outlet.

WARNING: ROUTE POWER CORDS SO THAT THEY ARE NOT A TRIPPING HAZARD. MAKE CERTAIN THE POWER CORD WILL NOT BE PINCHED OR ABRADED BY FURNITURE. DO NOT INSTALL POWER CORDS UNDER RUGS OR CARPET.

THE POWER CORD HAS A GROUNDING PIN. IF YOUR POWER OUTLET DOES NOT HAVE A GROUNDING PIN RECEPTACLE, DO NOT MODIFY THE PLUG. DO NOT OVERLOAD THE CIRCUIT BY PLUGGING TOO MANY DEVICES IN TO ONE CIRCUIT.

CAUTION: Ensure the DVR is not near any heat source that could cause overheating.

CAUTION: The DVR does not have an internal fan so leave a clearance of at least 6 inches near ventilation hole areas on each side panel of the unit for proper ventilation.

Your DVR is now ready to operate. Refer to *Chapter 3 – Configuration* and *Chapter 4 – Operation*.

Chapter 3 – Configuration

NOTE: Your DVR should be completely installed before proceeding. Refer to *Chapter 2 – Installation*.

Front Panel Controls

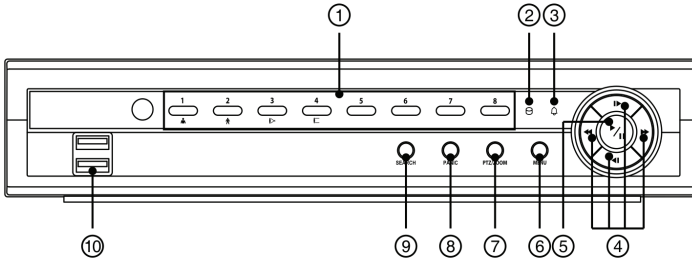

Figure 3 – 8-Channel DVR front panel.

- | | | | |
|---------------------|---------------|-------------------|-----------------|
| ① Camera Buttons | ② HDD LED | ③ Alarm Out LED | ④ Arrow Buttons |
| ⑤ Play/Pause Button | ⑥ Menu Button | ⑦ PTZ/Zoom Button | ⑧ Panic Button |
| ⑨ Search Button | ⑩ USB Port | | |

The front panel looks and operates much like a VCR combined with a multiplexer. Many of the buttons have multiple functions. The buttons on the infrared remote control, while laid out differently, perform the same functions as those on the front panel. The following describes each button and control. Take a few minutes to review the descriptions. You will use these to initially set up your DVR and for daily operations.

NOTE: A separate Alarm button is not provided. Pressing any button on the front panel or remote control resets alarm output including the internal buzzer when the alarm is activated. However, when you are in the menu or PTZ mode, you have to exit the menu or PTZ mode first to reset alarm output.

NOTE: The infrared sensor is just to the left of the **CAMERA 1** button. Make certain that nothing blocks the sensor, or the remote control will not function properly.

NOTE: You can also use a USB mouse (not supplied) to navigate through the screens and menus much like you would on a computer.

Camera Buttons (1 to 8)

Pressing the individual camera buttons will cause the selected camera to display full screen, and pressing the button again toggles between different display formats. The available formats are: PIP, 2x2, 1+5, 1+7 and 3x3. Buttons 1 to 8 are also used to enter passwords.

In the PTZ mode, pressing the button 1 zooms in the screen and the button 2 zooms out the screen, and pressing the button 3 focuses near and button 4 focuses far.

HDD LED

The HDD LED flickers when the DVR is recording or searching video on the hard disk drive.

















Alarm LED

The Alarm LED is lit when alarm output or internal buzzer is activated.



Arrow Buttons

These buttons are used to navigate through menus and GUI. You can also use them to change numbers by highlighting a number in the menu and using the Up and Down arrow buttons to increase or decrease the number's value.

These buttons are also used to control Pan and Tilt when in the PTZ mode. When in the PIP display format, pressing the Up and Down arrow buttons moves the position of the small screen counter-clockwise and clockwise, and pressing the Left and Right buttons changes the PIP screen size.

In the playback mode, pressing the  button plays video backward at high speed. Pressing the button again toggles the playback speed from ,  and , and the screen displays ,  and  respectively. While playing video, pressing the  button plays video forward at high speed. Pressing the button again toggles the playback speed from ,  and , and the screen displays ,  and  respectively. When in the pause mode, pressing the  button moves to the next image and pressing the  button moves to the previous image.

Play/Pause Button

In the live monitoring mode, pressing the  button freezes the current screen and the screen displays  icon. When in the playback mode, pressing the  button pauses playing video.



Pressing the  button selects a highlighted item or completes an entry that you have made during system setup.

Menu Button

In the Live Monitoring mode and Search mode, pressing the  button displays the menu icons at the top of the screen. Pressing the button also hides the menu icons. During menu setup, pressing the button closes the current menu or setup dialog box.

When in the live mode, pressing and holding the  button for three seconds or longer displays live channels sequentially.

PTZ/Zoom Button



In the live monitoring mode, pressing the  button enters the zoom mode, and pressing the button again exits the zoom mode. When in the zoom mode, a rectangle displays on the screen. A rectangle shows the area that will be enlarged. You can move the rectangle around using the arrow buttons. Pressing the  (Play/Pause) button enlarges the area in rectangle.

In the live monitoring mode, pressing and holding the **PTZ/ZOOM** button for three seconds or longer enters the PTZ mode, and pressing and holding the button again for three seconds or longer exits the PTZ mode. When in the PTZ mode, pressing the arrow buttons or **MENU** button allows you to control properly configured cameras.

Panic Button

Pressing the **PANIC** button starts panic recording of all camera channels, and displays  on the screen. Pressing the button again will stop panic recording.

Search Button

Pressing the **SEARCH** button enters the search mode, and pressing the button again exits the search mode. When entering the search mode, video is paused. Pressing the  (Play/Pause) button plays back video at regular speed. The screen displays  when the DVR is in the Pause mode and the screen displays  when the DVR is playing back video. The button is also used to load a Preset View in the PTZ mode.

USB Port

A USB port on the front panel is provided to connect external hard disk or flash drives for video clip copying or system upgrades. Position external drives close enough to the DVR so that you can make the cable connections, usually less than 6 feet. Use the USB cable provided with the hard disk drive to connect it to the DVR.

A USB mouse (not supplied) can be connected to the USB port. You can use the mouse to navigate through the screens and menus much like you would on a computer.

A USB to Serial converter can be connected to the USB port. Multiple text-in devices can be used with a USB to Serial converter.

Remote Control Buttons

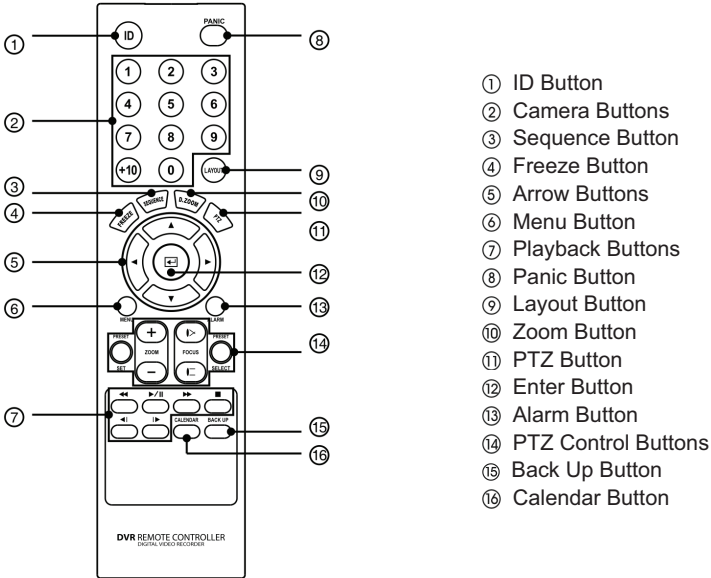

Figure 4 – Infrared remote control.

ID Button

If a DVR System ID is set to 0, the infrared remote control will control that DVR without any additional operations. (Refer to the *System Information* setup screen in this chapter for further information on setting the System ID.) If the system ID is 1 to 16, you must to press the **ID** button and then press the number button (1 to 16 (+10 & 6)) in order to control that DVR. If the System ID of two or more DVRs is set to 0, those DVRs will react to the infrared remote control at the same time.

Camera Buttons

Pressing the individual camera buttons will cause the selected camera to display full screen. Buttons 1 to 8 are also used to enter passwords.

Sequence Button

When in the Live Monitoring mode, pressing the **SEQUENCE** button displays live channels sequentially.

Freeze Button

Pressing the **FREEZE** button freezes the current live screen.

Arrow Buttons

These buttons are used to navigate through menus and GUI. You can also use them to change numbers by highlighting a number in the menu and using the **Up** and **Down** arrow buttons to increase or decrease the number's value. These buttons are also used to control Pan and Tilt when in the PTZ mode.













When in the PIP display format, pressing the **Up** and **Down** arrow buttons moves the position of the small screen counter-clockwise and clockwise.

Pressing the **Left** and **Right** buttons moves through screen pages in the Live Monitoring mode and Search mode.

Menu Button

In the Live Monitoring mode and Search mode, pressing the **MENU** button displays the menu icons at the top of the screen. Pressing the button also hides the menu icons. During menu setup, pressing the button closes the current menu or setup dialog box.

Playback Buttons

- **Rewind:** Pressing the  button plays video backward at high speed. Pressing the button again toggles the playback speed from ,  and .
- **Play/Pause:** Pressing the  button plays back video at regular speed. The screen displays **II** when the DVR is in the Pause mode and the screen displays **▶** when the DVR is playing back video.
- **Fast Forward:** Pressing the  button plays video forward at high speed. Pressing the button again toggles the playback speed from ,  and .
- **Stop:** Pressing the  button stops playback and enters the Live Monitoring mode.
- **Backward:** When in the pause mode, pressing the  button moves to the previous image.
- **Forward:** When in the pause mode, pressing the  button moves to the next image.

In the Live Monitoring mode, pressing any playback button enters to the Search mode.

Panic Button

Pressing the **PANIC** button starts panic recoding of all camera channels, and displays  on the screen. Pressing the button again will stop panic recording.

Layout Button

Pressing the **LAYOUT** button toggles between different display formats. The available formats are: 3x3, 1+7, 1+5, 2x2 and PIP.

Zoom Button

Pressing the **ZOOM** button zooms the current image on the screen. A PIP with a rectangle temporarily displays showing what area of the screen has been enlarged. You can use the arrow buttons to move the rectangle to another area.

PTZ Button

Pressing the **PTZ** button enters the PTZ (Pan/Tilt/Zoom) mode which allows you to control properly configured cameras.

Enter Button

The **Enter** button selects a highlighted item or completes an entry that you have made during system setup. This button is also used to enter the Cameo mode in the Live Monitoring mode or Search mode (8-ch Model Only).

Alarm Button

Pressing the **ALARM** button resets the DVR's outputs including the internal buzzer during an alarm.

PTZ Control Buttons

While in the PTZ mode, the **PRESET** buttons are used to save Presets and load a Preset View, the **ZOOM** buttons are used to Zoom In and Zoom Out, and the **FOCUS** buttons are used for Near Focus and Far Focus.

Back Up Button

Pressing the **BACK UP** button allows you to copy video clips.

Calendar Button

In the search mode, pressing the **CALENDAR** button displays the Calendar Search screen.

Turning on the Power

Connecting the power cord to the DVR turns on the unit. The unit takes approximately 60 seconds to initialize.

Initial Unit Setup

Before using your DVR for the first time, you will want to establish the initial settings. This includes items such as time and date, display language, camera, audio, remote control, record mode, network and password. Your DVR can be set up using various screens and dialog boxes.

Throughout the screens you will see **ESC**. Highlighting the **ESC** and pressing the **Play/Pause** button gives you the opportunity to reset that screen to its default settings. After you are finished with any setup screen, you can highlight **Save** and press the **Play/Pause** button to save the changes and exit the screen. If you do not wish to save the changes, highlight **Cancel** and press the **Play/Pause** button to exit the screen.

Press the **MENU** button or move the mouse pointer to the top of the screen and then select **[F]** (Login) in the Live Monitoring menu to enter the setup screens. The Login screen appears.



Figure 5 – Login screen.

Select a User and enter the password by pressing the appropriate combination of Camera number buttons and then the **[F]** button. There is no default password when logging in the admin user for the first time.

NOTE: To assure the secure management of the system, setting up a password is strongly recommended.

NOTE: If you cannot use the front panel buttons, click the **[...] button using the mouse to enter a password, and the virtual keyboard displays. See instructions below for using the virtual keyboard.**

NOTE: To log the user out of the system, press the **MENU button on the front panel or move the mouse pointer to the top of the screen and then select **[F]** (Logout) in the Live Monitoring menu. The Logout screen displays asking you to confirm whether or not you want to log out the current user.**

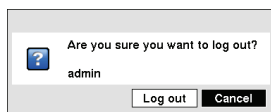

Figure 6 – Logout screen.

Setup Screen

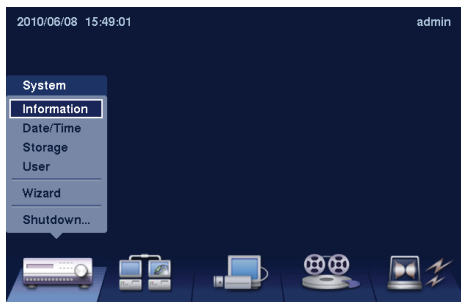
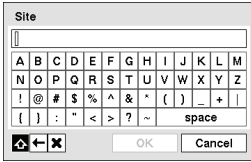

Figure 7 – Setup screen.

Press the **MENU** button on the front panel or move the mouse pointer to the top of the screen and then select **[G]** (Setup) in the Live Monitoring menu to enter the setup screen.

While setting up the DVR, there will be many opportunities to enter names and titles. When making these entries, a Virtual Keyboard will appear.



Use the arrow keys to highlight the character you want in the name or title and press the button. That character appears in the title bar and the cursor moves to the next position. Pressing toggles between the upper and lower case keyboards, backspaces, and deletes entered characters. You can use up to 31 characters including spaces in your title.

Special characters can be created using ^ and a capital letter; e.g. ^J for NL (New Line), ^M for CR (Carriage Return). Special characters are commonly used by text input devices and will be useful when performing Text-In Searches.

System Setup



Figure 8 — System menu.

Information

Highlight Information in the System menu and press the button. The Information setup screen appears.

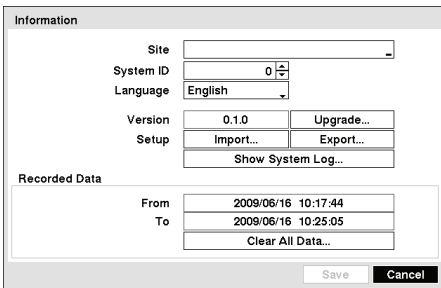

Figure 9 — Information setup screen.

In the Information screen, you can name the site location, assign a System ID number, select the language the screens are displayed in, display software version number, upgrade the software, show the System Log, display recorded time data, and clear all data.

Highlight the Site box and press the button. A virtual keyboard appears that you can use to enter a Site Name. Once you have entered your title, highlight Close and press the button.

Highlight the box beside System ID and press the button. Change the number by highlighting it and using the Up and Down arrow buttons to increase and decrease the number from 0 to 99.

NOTE: The System ID number is used to identify the unit when it is connected with other DVRs through the RS485 port. You cannot use the same ID number for two or more DVRs that are in the same RS485 network. It is possible to have multiple DVRs with System ID 0 that are in the same area as long as they are not part of an RS485 network. If this is the case, all will be controlled at the same time when using the infrared remote control.

Highlight the box beside **Language** and press the \odot button. A drop-down menu displays the available languages. Highlight the desired language and press the \odot button.

The box beside **Version** displays the software version of the DVR.

To upgrade the software, connect a USB device containing the upgrade package file to the DVR. Highlight **Upgrade...** and press the \odot button. The **Upgrade** screen appears.



The screen displays the upgrade package file names that are available. The “.rui” indicates that the file is for software upgrades. Select the desired file and press the \odot button.

Highlighting the **Install** button and pressing the \odot button will install the selected software package. Highlighting the **Cancel** button and pressing the \odot button will close the window without upgrading the software. If the upgrade package file is not installed on the DVR properly, you will get an error message.

CAUTION: The system restarts automatically after completing the upgrade, and it takes approximately one minute to restart. Do NOT remove the USB device until the DVR restarts, otherwise the system upgrade will not be completed properly.

CAUTION: The USB device must be FAT16 or FAT32 format.



You can import saved DVR settings or export the current DVR settings. To import saved DVR settings, connect the USB device containing the setup file (.dat) to the DVR. Highlight **Setup – Import...** and press the \odot button.

Select the desired setup file and press the **Import** button to import the selected settings and change the DVR settings accordingly. Highlight **Include Network Setup** and press the \odot button to toggle between On and Off. When set to Off, the network settings will not be changed.



To export the current DVR settings, connect the USB device to the DVR. Highlight **Setup – Export...** and press the \odot button.

Highlight the box beside **File name** and press the \odot button. A virtual keyboard allows you to enter the file name. Selecting **Export** will save the current settings in .dat file format on the USB device.

NOTE: Even after changing the DVR settings by importing saved settings, the time-related settings (Date/Time, Time Zone and Daylight Saving Time) will NOT be changed.



CAUTION: The USB device must be FAT16 or FAT32 format.

Highlight **Show System Log...** and press the \odot button to display the System Log.

System Log		Time	Type
		2010/06/07 13:30:51	Setup Begin
		2010/06/07 13:30:49	Login : admin
		2010/06/07 13:30:47	Logout : admin
		2010/06/07 13:30:45	Setup End
		2010/06/07 13:30:39	Setup Begin
		2010/06/07 13:30:38	Setup End
		2010/06/07 13:29:34	Setup Begin
		2010/06/07 13:29:24	Setup End
		2010/06/07 13:29:23	Setup Begin
		2010/06/07 13:29:23	Login : admin

1 / 2 Export... ▲ ▼

Close

The System Log screen lists system activities (up to 5,000 from the latest) that have occurred along with the time and date. The  icon will be displayed in the last column for system activities of the remote site. You can scroll through the log pages by using the Up and Down arrows, or you can go directly to a log page by entering the log page number in the box at the bottom left of the screen. Highlight **Close** and press the  button to exit the screen.

System Log Export

File name

Export **Cancel**

To export the system log information, connect the USB device to the DVR. Highlight **Export...** and press the  button.

Highlight the box beside **File name** and press the  button. A virtual keyboard allows you to enter the file name. Selecting **Export** will save the log information in .txt file format on the USB device.

NOTE: When opening the saved .txt file, setting to the proper character encoding and using fixed width fonts will be required to read the file properly.

The box beside **Recorded Data – From / To** displays the time information of recorded data.

Highlighting **Clear All Data...** and pressing the  button will clear all video data. You will be asked to verify that you wish to clear all data before the DVR erases the video data. **Clear All Data...** will not clear the System Log.



Date/Time

Highlight **Date/Time** in the System menu and press the  button. The **Date/Time** setup screen appears.

Date/Time

Date/Time	Holiday	Time Sync.
Date	2009/06/17	Format
Time	14:38:52	Format
Time Zone	GMT-05:00 Eastern Time (US & Ca.)	
	<input checked="" type="checkbox"/> Enable Daylight Saving Time	

Save **Cancel**

Highlight the first box beside **Date** and press the  button. The individual sections of the date will highlight. Use the Up and Down arrow buttons to change the number. Use the Left and Right arrow buttons to move between month, date and year. Once you have the correct date, press the  button.



Highlight the **Format** box beside **Date** and press the  button. Select from the three available date formats and press the  button to save your selected format.

Figure 10 – Date/Time setup screen.

Highlight the first box beside **Time** and press the \odot button. The individual sections of the time will highlight. Use the **Up** and **Down** arrow buttons to change the number. Use the **Left** and **Right** arrow buttons to move between hour, minutes and seconds. Once you have the correct time, press the \odot button.

Highlight the **Format** box beside **Time** and press the \odot button. Select from the three available time formats and press the \odot button to save your selected format.

NOTE: The clock will not start running until you have highlighted **Save and pressed the \odot button.**

Highlight the box beside **Time Zone** and press the \odot button. Select your time zone from the list and press the \odot button.

Highlight **Enable Daylight Saving Time** and press the \odot button. Pressing the \odot button toggles between **On** and **Off**.

Highlight the **Holiday** tab, and the **Holiday** setup screen appears.

No.	Date	
		X
		X
		X
		X
		X
		X
		X
		X
		X
		X
		X
		X
		X
		X

You can set up holidays by highlighting **+** and pressing the \odot button. The current date appears.

Highlight the month and day and change them by using the **Up** and **Down** arrow buttons. Press the \odot button to add the date. Dates can be deleted by highlighting the **X** beside the date and pressing the \odot button.

NOTE: Holidays that do not fall on the same date each year should be updated once the current year's holiday has passed.

Figure 11 — Holiday setup screen.

Highlighting the **Time Sync.** tab causes the **Time Sync.** setup screen to display. You can set up time synchronization between the DVR and standard time servers that are available in most time zones and countries, or between the DVR and another DVR.

Highlight the box beside **Automatic Sync.** and press the \odot button. This toggles between **On** and **Off**.



Highlight the box beside **Time Server** and press the \odot button. A virtual keyboard appears that you can use to enter the IP address or domain name of the time server.

NOTE: You can use the domain name instead of IP address if you already set up the DNS Server when setting up the LAN.

Figure 12 — Time Sync. setup screen.

Highlight the box beside **Interval** and press the  button. Set the time interval for synchronization from 30 minutes to 1 day at various time intervals.

Last Sync-Time displays the last time the DVR was synchronized with the time server.

Highlight **Run as Server** and press the  button. Pressing the  button toggles between **On** and **Off**. When it is **On**, the DVR you are setting up will run as a time server.

Storage

Highlight **Storage** in the System menu and press the  button. The **Storage** setup screen appears and displays information about the DVR's storage devices.

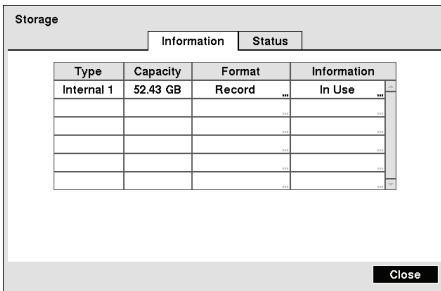



The information in the **Type** column describes the storage device.

The capacity of the storage device is displayed in the **Capacity** column.

The **Format** column displays whether the device is used for recording (**Record**) or not (**Not Using**). **Not formatted** indicates the device is not formatted.

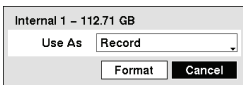
Figure 13 – Storage Information setup screen.





Highlight the box in the **Format** column for the desired storage device and press the  button. You will be able to format the device for recording. When selecting **Not Using** from **Use As** and highlighting the **Format** button, the device will not be used for recording.

NOTE: The DVR does NOT support USB hard disk drives with a version lower than 2.0.

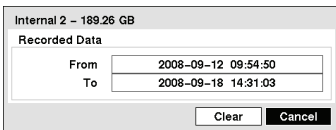
The **Information** column displays whether the device is being used or not. **Other** indicates the device has been used for another DVR.



Highlight the box in the **Information** column for the desired storage device and press the  button. The box beside **Recorded Data** – **From / To** displays the time information of recorded data.

Highlighting **Clear** and pressing the  button will clear all video data. You will be asked to verify that you wish to clear all data before the DVR erases the video data.

CAUTION: Do NOT disconnect the USB cable or the power from the device while copying video clips. If the USB cable is disconnected while copying video clips, archived data might be lost.

Highlight the **Status** tab, and the **Storage Status** setup screen displays.

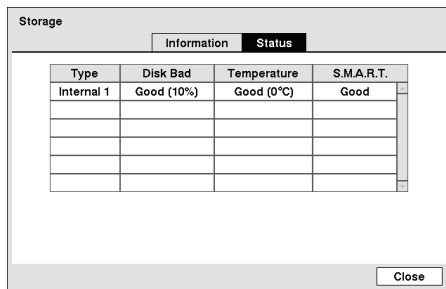

Figure 14 – Storage Status setup screen.

The **Type** column displays the type of storage device.

The **Disk Bad** column displays the percentage of bad sectors.

- Not formatted – The device is not formatted.
- Good – Less than user-defined percentage level of bad disk sections is damaged.
- Bad – More than user-defined percentage level of bad disk sections is damaged.

The **Temperature** column displays the temperature of the storage device.

- Good – The temperature does not exceed the user-defined temperature threshold.
- Bad – The temperature exceeds the user-defined temperature threshold.
- N/A – The DVR cannot read the temperature.

The **S.M.A.R.T.** column displays “Good”, “Bad” or “N/A”, depending on storage conditions.

- Good – The storage condition is normal.
- Bad – Data cannot be written on or read from the storage device.
- N/A – Storage conditions are normal, however, the S.M.A.R.T. monitoring is not working or supported.

NOTE: When the S.M.A.R.T. displays *Bad*, the screen displays a message box. Once the “Bad” message displays, replacing the hard disk drive is recommended, usually within 24 hours.

NOTE: *Temperature* and *S.M.A.R.T.* information will be available only for internal hard disk drives supporting the SMART (Self-Monitoring Analysis and Reporting Technology) monitoring program.

Wizard

Highlight Wizard and press the  button. The Setup wizard screen appears. The Setup wizard guides you to configure the system for basic operation.

NOTE: This *Setup wizard* screen can only be accessed when logging in the *admin* user.

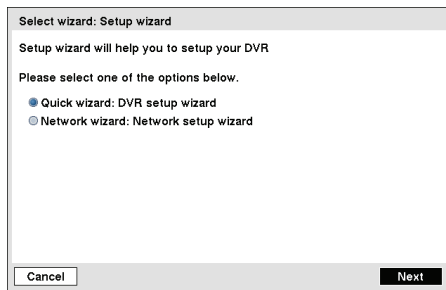

Select the setup wizard option between Quick wizard and Network wizard, and then select the Next button to start the selected setup wizard.

NOTE: Selecting the *Cancel* button throughout the screens exits the Setup Wizard without saving your changes and return to the main setup screen.

Figure 15 – Setup wizard screen.

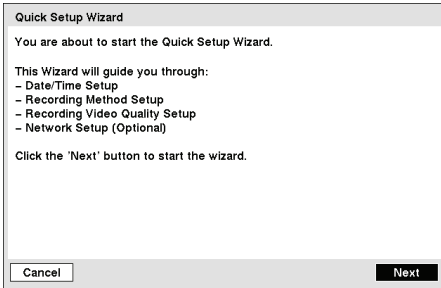
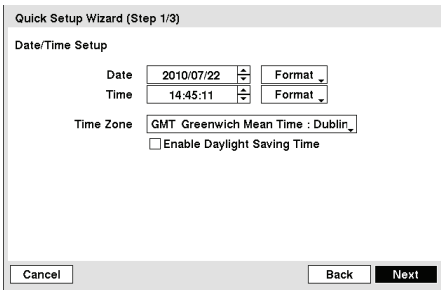

Figure 16 – Quick Setup Wizard screen.



Select the **Next** button to start the Quick Setup Wizard.

Date/Time Setup

- **Date:** Set the system date and select the date format.
- **Time:** Set the system time and select the time format.
- **Time Zone:** Select your time zone.
- **Use Daylight Saving Time:** Selecting the box sets the system to use daylight saving time.

NOTE: The Date/Time will be set, and the clock will start when you click the *Next* button.

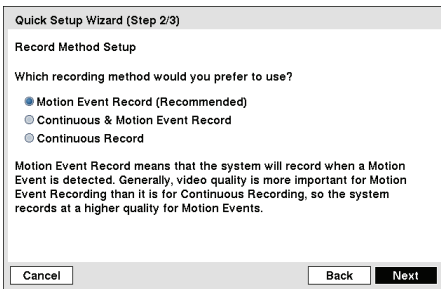

Record Method Setup

- Select the desired recording mode from:
 - Motion Event Record (Recommended)
 - Continuous & Motion Event Record
 - Continuous Record

NOTE: You should understand each recording mode before selecting the DVR's recording method.

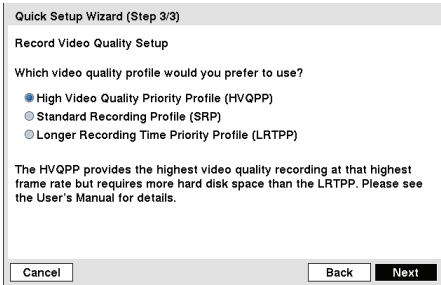

Record Video Quality Setup

- Select the desired video quality profile from:
 - Higher Video Quality Priority Profile
 - Standard Recording Profile
 - Longer Recording Time Priority Profile

NOTE: The higher quality setting requires more storage space.

NOTE: The recording resolution will be set to **Very High** when selecting **High Video Quality Priority Profile**, **High** when selecting **Standard Recording Profile**, and **Standard** when selecting **Longer Recording Time Priority Profile**.

NOTE: The recording quality and recording speed of each camera channel will be set like below according to the **Record Method** and **Record Video Quality** you set.

	HVQPP*	SRP*	LRTPP*
Motion Event Record	Very High / 30 ips	High / 5 ips	Standard / 2.5 ips
Continuous & Motion Event Record	Very High / 30 ips (Time) Very High / 30 ips (Event)	High / 5 ips (Time) Very High / 30 ips (Event)	Standard / 2.5 ips (Time) High / 5 ips (Event)
Continuous Record	Very High / 30 ips	High / 5 ips	Standard / 2.5 ips

* Record Video Quality: HVQPP (High Video Quality Priority Profile), SRP (High Video Quality Priority Profile), LRTPP (Longer Recording Time Priority Profile)

Select the **Finish** button to finish the Quick Setup Wizard and select the **Go to Network Setup** button to start the Network Setup Wizard.

Select the **Next** button to start the Network Setup Wizard.

Figure 17 – Network Setup Wizard screen.

Network Setup Wizard (Step 1/3)
Internet Connection

Is your DVR connected to the Internet?

Yes (I will use an Internet connection)
 No (I will Not use an Internet connection)

Cancel Back Next

Internet Connection

Select whether or not your DVR is connected to the Internet.

Network Setup Wizard (Step 2/3)
LAN Setup

Auto Configuration Test

Get IP, Gateway, Subnet Mask
 Use DSL/PPPoE Setup
Search DNS Server
Check Internet connectivity
Search uPnP/PortForwarding

Cancel Back Next

LAN Setup

Select the desired network configuration between Auto Configuration and Manual Configuration, and then select the Test button to test the network configuration you set.

NOTE: Selecting *Auto Configuration* allows the DVR to obtain LAN parameters (IP address, Gateway, Subnet Mask and DNS Server address) automatically. Selecting *Manual Configuration* allows you to set up LAN parameters manually.

NOTE: The network configuration you set should be tested by selecting *Test*, otherwise the *Next* button will not be selected so that you cannot move to the next step.

- Use DSL/PPPoE Setup: Selecting the box allows you to set up the DSL network. Entering the ID and password for DSL connection will be required.

NOTE: When error message “No Device supporting uPnP” displays, check the NAT device supports the UPnP Port Forwarding function and the function is set to enabled.

Network Setup Wizard (Step 3/3)
DVRNS Setup

DVRNS Server dvrnames.net
Port 10088 (10000 - 12000)
DVR Name
Check

You may register your DVR name and use it instead of the IP address when accessing the DVR through internet. Type in your preferred DVR name and check its availability.

Cancel Back Next

DVRNS Setup

- Enable NAT: Select the box when using the NAT (Network Address Translation) device.
- DVR Name: Enter the DVR name to be registered on the DVRNS server.
- Check: Selecting the box to check whether or not the name you entered can be used.

NOTE: The DVR name you entered should be checked by selecting *Check*, otherwise the DVRNS changes will not be saved.

NOTE: When entering no name or a name already registered on the DVRNS server, an error message displays.



Select the Finish button to finish the Setup Wizard.

User

Highlight User in the System menu and press the button. The User setup screen displays the authorized groups and users. You can add and delete groups and users. When adding a group, you can assign authority levels to the group.

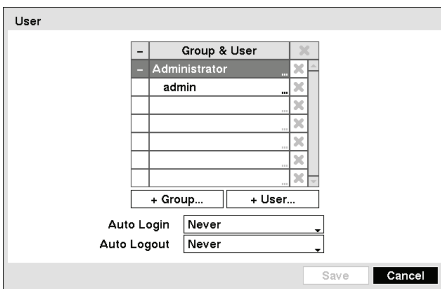

Figure 18 – User setup screen.

The +/- column is used to collapse and expand user groups. If there is a + or – in this column, it indicates the item is a Group Name. If there is a – in front of the Group Name, it indicates that the group has been “expanded” and all of the User Names within that group are displayed below the Group Name. If there is a + in front of the Group Name, it indicates that the group has been “collapsed” and all of the User Names within that group are hidden. To collapse or expand a group, highlight the +/- column in front of the desired group and press the button.

Highlighting a Group Name and pressing the button allows you to change the authority levels assigned to the group.



CAUTION: Write down the new password and save it in a secure place. If the password is forgotten, the unit must be reset using the *Factory Reset Button* and all data settings will be lost.

Highlighting a User Name and pressing the button allows you to add or change the password assigned to that user. You can also change the group to which the user is assigned.

The column can be used to delete a User Name or an entire Group. If the is grayed out, that Group or User cannot be deleted. Highlight the and press the button. You will be asked to confirm that you want to delete the User or Group. To delete the User currently logged into the DVR on a local system or a PC running RAS, log the user out of the system first and then delete the user.

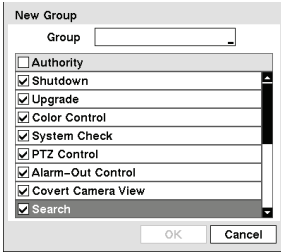
To add a Group, highlight the + Group... box and press the button. A virtual keyboard appears allowing you to enter the Group name.



You can use up to 15 characters including spaces in the group name. Enter the name and assign authority levels to the group. Highlighting the Authority box and pressing the  button will toggle between all authority levels being turned On and Off. Highlighting the individual authority level boxes and pressing the  button will toggle between that authority level being turned On and Off. The authority levels that can be turned On and Off are:

- Shutdown – The user can shut the system down on a local system.
- Upgrade – The user can upgrade the software on a local system or a PC running RAS.
- Color Control – The user can control brightness, contrast, hue and saturation for cameras on a local system or a PC running RAS.
- System Check – The user can view the remote system status or check the remote system status as a batch process on a PC running RAS.
- PTZ Control – The user can control the PTZ camera on a local system or a PC running RAS.
- Alarm-Out Control – The user can reset the DVR's outputs including the internal buzzer during an alarm by pressing any button on the front panel or remote control on a local system or alarm-out control button on a PC running RAS.
- Covert Camera View – The user can view video from cameras set as Covert while in the Live Monitoring or Search mode on a local system or a PC running RAS.
- Search – The user can access the Search mode on a local system or a PC running RAS.
- Clip-Copy – The user can copy video clips on a local system or a PC running RAS.
- Setup – The user without Setup authority cannot establish any system settings excluding system shutdown and logout on a local system or a PC running RAS.
- System Time Change – The user can change the system date and time on a local system or a PC running RAS.
- Data Clear – The user can clear all video data or format disks on a local system or a PC running RAS.
- PTZ Setup – The user can establish all PTZ settings on a local system or a PC running RAS.
- Alarm-Out Setup – The user can establish all Alarm-Out settings on a local system or a PC running RAS.
- Covert Camera Setup – The user can establish all Covert Camera settings on a local system or a PC running RAS.
- Record Setup – The user can establish all Record settings on a local system or a PC running RAS.

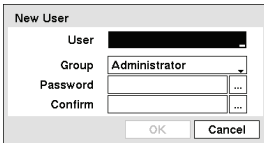

To add a User, highlight the + User... box and press the  button. A virtual keyboard appears allowing you to enter the User Name. Enter the name and assign the User to a Group and password. You can use camera buttons 1 to 8 on the front panel to assign the password. The password can be up to 8 digits. You will be asked to confirm the password.

NOTE: In addition to using the front panel buttons or the infrared remote control, you can use the virtual keyboard to assign the password. To display the virtual keyboard click the  button using the mouse (not supplied).

Highlighting the box beside Auto Login allows you to select a User to be automatically logged in when the DVR is powered up. It can also be set to never automatically login a user.

Highlighting the box beside **Auto Logout** allows you to select from a list of times that the user will be automatically logged out. The options are: Never, 1 min., 3 min., 5 min., 10 min., 15 min., 20 min., 25 min., 30 min. and 1 hr.

Shutdown

Highlight **Shutdown** in the System menu and press the  button. The **Shutdown** screen displays asking you to confirm whether or not you want to shut the system down.

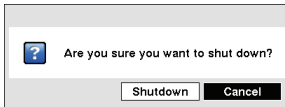

After selecting **Shutdown** and pressing the  button, a screen will appear telling you when it is safe to disconnect power.

Figure 19 – Shutdown screen.

Network Setup

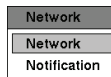



Figure 20 – Network menu.

Network

Highlight **Network** in the Network menu and press the  button. The **Network** setup screen displays.

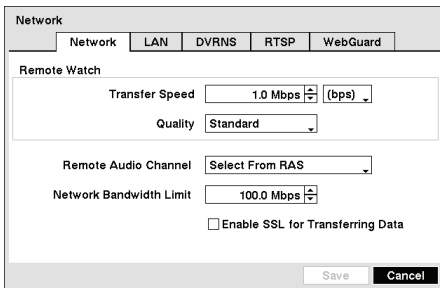





Figure 21 – Network setup screen.

Highlight the first box beside **Remote Watch – Transfer Speed**. Press the Up and Down arrow buttons to set the Transfer Speed from 50Kbps to 100Mbps.

Highlight the second box beside **Remote Watch – Transfer Speed**. You can select the unit of measure for the transfer speed between: bps and ips. Press the  button to set the transfer speed.

NOTE: The local recording speed might be affected by various network bandwidth (Transfer Speed) conditions.

Highlight the box beside **Remote Watch – Quality** and press the  button. You can select the Quality from: Very High, High, Standard and Basic. Press the  button to set the Quality.

NOTE: The higher Quality settings require higher Transfer Speed settings. The transfer speed you set is the maximum speed. Depending on the network environment, this speed may not be achieved.

The DVR supports two-way audio communication between a local system and a PC running RAS. Highlighting the box beside Remote Audio Channel and pressing the  button allows you to select the audio channel that sends audio to the remote site. Selecting Select From RAS will send audio of the channel selected from RAS.

NOTE: Depending on network conditions, audio might be interrupted or out of synchronization during transmission.

NOTE: Recorded audio might NOT be played properly on a PC running RAS when the DVR is connected to more than two RAS search programs at the same time.

You can limit the network bandwidth settings so that system does not consume too much network bandwidth. Highlight the box beside Network Bandwidth Limit and press the Up and Down arrow buttons to set the desired maximum bandwidth from 10Kbps to 100Mbps.

NOTE: When limiting the network bandwidth, the remote watch image on the PC running RAS or WebGuard might not be displayed properly.

Highlight Enable SSL for Transferring Data and press the  button to toggle between On and Off. When it is On, the security of data except video and audio transmitted for remote monitoring or remote recording can be enhanced by using the SSL (Secure Sockets Layer) authentication. When using the SSL function, the DVR cannot be connected with a remote program or a network keyboard which does not support the SSL function.

CAUTION: The remote connection will be disconnected temporarily after changing the SSL settings.

NOTE: This product includes software developed by the OpenSSL Project for use in the OpenSSL Toolkit (<http://www.openssl.org/>).

Highlight the LAN tab, and the LAN setup screen displays.

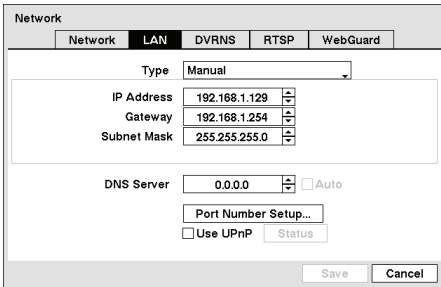



Figure 22 – LAN (Manual) setup screen.

Highlight the box beside Type and press the  button. You can select the type of network configuration from: Manual, DHCP and ADSL (with PPPoE). Select the desired type and press the  button.

Selecting Manual from the Type allows you to set up LAN parameters manually.

Change the numbers by highlighting them and using the Up and Down arrow buttons to increase or decrease the number. The factory default LAN settings are:

IP Address: 192.168.1.129
 Gateway: 192.168.1.254
 Subnet Mask: 255.255.255.0

NOTE: You will need to get the appropriate IP Address, Gateway and Subnet Mask from your network administrator.

Highlight the box beside DNS Server. Press the Up and Down arrow buttons to set the IP address of the DNS server.

Highlight Use UPnP and press the  button to toggle between On and Off. When it is On, port forwarding from the NAT (Network Address Translation) device to the DVR will be enabled automatically via UPnP (Universal Plug and Play) service. This function will be used especially when accessing to a port on a private IP address.

NOTE: For the UPnP service to work, the NAT device should support the UPnP Port Forwarding function and the function should be set to enabled.

NOTE: You cannot change the port settings when Use UPnP is On.

Highlight the Status box and press the  button to display the port numbers forwarded from the NAT device via UPnP service.

Highlight the Port Number Setup... box and press the  button. The Port Number Setup screen appears.

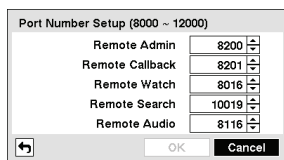

Change the numbers by highlighting them and using the Up and Down arrow buttons to increase or decrease the number. The factory default Port settings are:

Remote Admin: 8200
 Remote Callback: 8201
 Remote Watch: 8016
 Remote Search: 10019
 Remote Audio: 8116

NOTE: You will need to get the appropriate Port Numbers for each RAS and WebGuard related program (Admin, Callback, Watch, Search and Audio) from your network administrator.

NOTE: Do NOT use the same port number for two different programs, otherwise, the DVR cannot be connected with the PC running RAS or WebGuard.

CAUTION: When changing the port settings, you must change the port settings on the PC running RAS as well. Refer to the RAS manual for details.

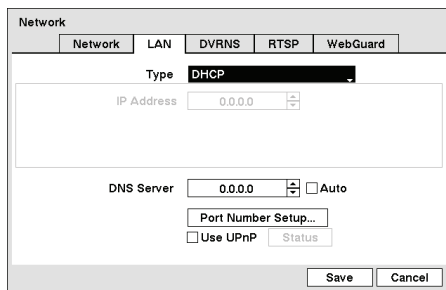

Selecting DHCP from the Type and highlighting Save button reads the current IP address of the DVR configured by DHCP (Dynamic Host Configuration Protocol) network.

Highlight Auto and press the  button to toggle between On and Off. When it is On, the DVR will obtain the IP address of the DNS server automatically.

NOTE: Selecting Auto will only be enabled when the DVR is configured for DHCP network.

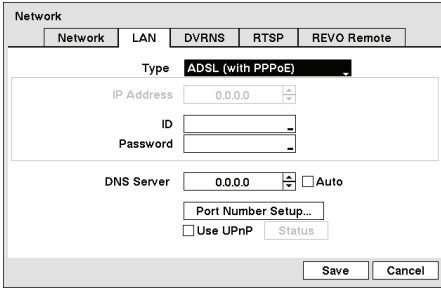

Selecting ADSL (with PPPoE) allows you to set up the ADSL network.

Highlight the box beside ID and press the button. A virtual keyboard appears allowing you to enter the ID for ADSL connection.

Highlight the box beside Password and press the button. A virtual keyboard appears allowing you to enter the password for ADSL connection.

NOTE: Entering the ID and Password and highlighting OK reads the current IP address of the DVR configured by the ADSL network.

NOTE: If the DVR is configured for DHCP or an ADSL network, the IP address of the DVR might change whenever the unit is turned on.

Highlight the DVRNS tab, and the DVRNS setup screen displays.

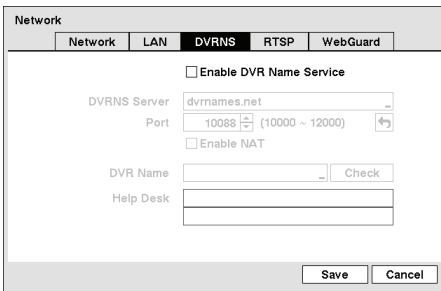

Highlight Enable DVR Name Service and press the button to toggle between On and Off.

NOTE: The DVRNS (DVR Name Service) allows the DVR to use Dynamic IP addresses for remote connection. When this feature is On, you can access your DVR remotely using the DVR name instead of its IP address. For the DVRNS feature, the DVR should be registered on the DVRNS server.

Highlight the box beside DVRNS Server and press the button. A virtual keyboard appears allowing you to enter the IP address or domain name of the DVRNS server.

Figure 23 – DVRNS setup screen.

NOTE: You will need to get the IP Address or domain name of the DVRNS Server from your network administrator.

NOTE: You can use the domain name instead of IP address if you already set up the DNS Server when setting up the LAN.

Highlight the box beside Port and press the button. Set the port number of the DVRNS server using the Up and Down arrow buttons to increase or decrease the numbers.

Highlight Enable NAT and press the button to toggle between On and Off.

NOTE: When using the NAT (Network Address Translation) device, refer to the NAT manufacturer' instructions for the proper network settings.

Highlight the box beside DVR Name and press the button. A virtual keyboard appears allowing you to enter the DVR name to be registered on the DVRNS server.

Highlight the Check box and press the  button to check whether or not the name you entered can be used.

NOTE: The DVR name you entered should be checked by selecting *Check*, otherwise the DVRNS changes will not be saved.

NOTE: When entering no name or a name already registered on the DVRNS server, an error message displays.

Highlighting *Save* and pressing the  button registers the DVR on the DVRNS server. Proper DVRNS settings will display the help desk information of the DVRNS server in the box beside Help Desk.

Highlight the RTSP tab, and the RTSP setup screen displays.

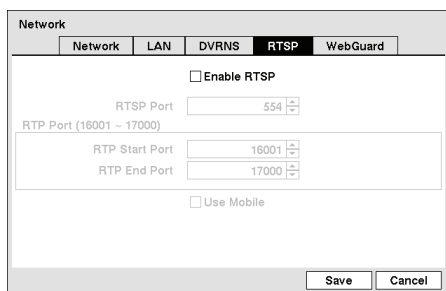





Figure 24 – RTSP setup screen.

Highlight *Enable RTSP* (Real-Time Streaming Protocol) and press the  button to toggle between On and Off. You will be able to change the settings if *Enable RTSP* is enabled.

NOTE: When selecting *Enable RTSP*, the recorded image resolution cannot be set to *Very High* during Record setup.

Highlight the box beside *RTSP Port* and press the  button. Set the port number of the RTSP server obtained from your system administrator.

Highlight the box beside *RTP Start Port* and press the  button. Set the start port number of the RTP server obtained from your system administrator.

Highlight the box beside *RTP End Port* and press the  button. Set the end port number of the RTP server obtained from your system administrator.

Highlight *Use Mobile* and press the  button to toggle between On and Off. When set to on, you can access a remote DVR using Blackberry or other mobile devices.

NOTE: Selecting *Use Mobile* sets the recorded image resolution to *Basic* automatically regardless of your Record settings.

NOTE: Selecting *Use Mobile* sets the WebGuard service to be enabled automatically regardless of your WebGuard settings.

NOTE: You can access a remote DVR and monitor live video images using the media players like VLC Player supporting the RTSP service. Start the media player on your local PC and enter “rtsp://ID:Password@IP address:RTSP port number/channel number”, or start Internet Explorer on your Blackberry or other mobile devices and enter “http://IP address: Webguard port number”.

NOTE: The RTSP service might not be supported, depending on the type of media player.

Highlight the **WebGuard** tab, and the WebGuard setup screen displays.

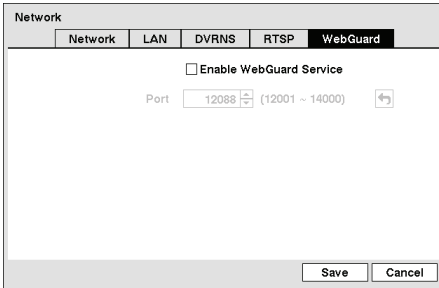

Highlight **Enable WebGuard Service** and press the button to toggle between On and Off. See *Appendix – WebGuard* for detailed descriptions of the WebGuard service.

Highlight the box beside **Port** and press the button. Set the port number used when accessing WebGuard by using the Up and Down arrow buttons to increase or decrease the numbers.

Figure 25 – WebGuard setup screen.

Notification

The DVR can be set up to send an email or to contact a computer running RAS (Remote Administration System) when an event occurs.

Highlight **Notification** in the Network menu and press the button. The Notification setup screen displays. You will be able to change the Mail and Callback settings.

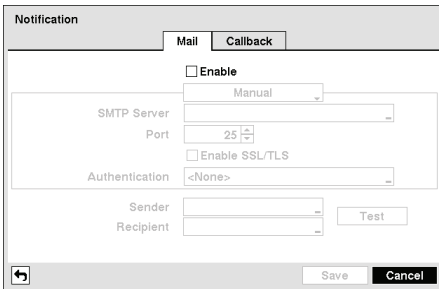

Highlight **Enable** and press the button to toggle between On and Off. You will only be able to change the settings if Mail is enabled.

Highlight the box beside **SMTP Server** and press the button. A virtual keyboard appears that you can use to enter the IP address or domain name of the SMTP server.

NOTE: You will need to get the IP Address or domain name of the SMTP Server from your network administrator.

Figure 26 – Notification Mail setup screen.

NOTE: You can use the domain name instead of IP address if you already set up the DNS Server when setting up the LAN.

Highlight the box beside **Port** and press the button. Use the arrow buttons to enter the SMTP Server port number obtained from your system administrator. The default port number is 25.

Highlight **Enable SSL/TLS** and press the button to toggle between On and Off. When it is On, the DVR can send an email via an SMTP server requiring SSL (Secure Sockets Layer) authentication.

Authentication

Use

User

Password

Highlight the box beside Authentication and press the button. An Authentication screen appears.

Highlight Use and press the button to toggle between On and Off. Highlight the box beside User/Password and press the button. A virtual keyboard appears allowing you to enter the user ID and password.

NOTE: This product includes software developed by the OpenSSL Project for use in the OpenSSL Toolkit (<http://www.openssl.org/>).

Highlight the box beside Sender and enter the sender's e-mail address. Use the virtual keyboard to enter the e-mail address.

NOTE: The e-mail address must include the "@" character to be a valid address.

Highlight the box beside Recipient and enter the recipient's e-mail address. Use the virtual keyboard to enter the e-mail address.

Highlight the Test box and press the button to test emailing with the current settings you made.

Highlight the Callback tab, and the Callback setup screen displays.

Notification

LAN

No.	IP Address
1	0.0.0.0
2	0.0.0.0
3	0.0.0.0
4	0.0.0.0
5	0.0.0.0

Retry

Figure 27 – Notification Callback setup screen.

Highlight LAN and press the button to toggle between On and Off. When LAN is turned On you can change the IP addresses.

Highlight the IP Address box that you want to change and press the button. Use the arrow buttons to enter the IP address of the computer you want contacted during an event. You can enter up to five IP addresses.

Highlight the box beside Retry and enter the number of times you would like the DVR to try contacting the computer. You can select from 1 to 10 retries.

Devices Setup

Devices

- Camera
- Audio
- Alarm-Out
- Display
- Remote Control

Figure 28 – Devices menu.

Camera

Highlight Camera in the Devices menu and press the  button. The Camera setup screen appears.

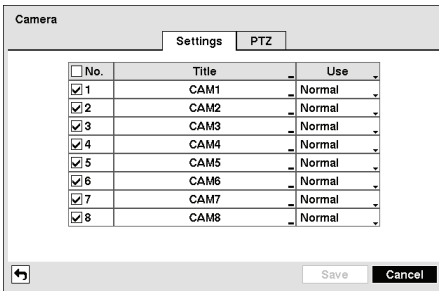

You can turn the camera number On or Off, and you can change the Title of each camera using the virtual keyboard. You can also determine which cameras will display on the monitors by selecting Normal, Covert 1 or Covert 2 from a drop-down list in the Use column.

NOTE: When selecting the *Covert 1*, the DVR displays the camera title and status icons on the covert video. When selecting the *Covert 2*, the DVR displays only camera title on the covert video.

Figure 29 – Camera setup screen.

NOTE: A user who does not have *Covert Camera View* authority cannot view video from cameras set to *Covert 1* or *Covert 2* in both the live monitoring and playback modes.

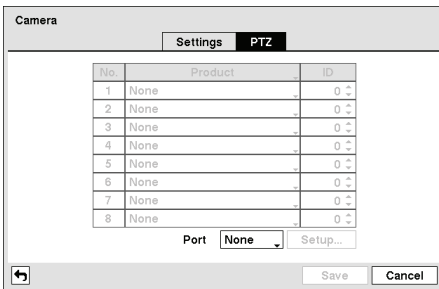

Highlight the PTZ tab, and the PTZ setup screen displays.

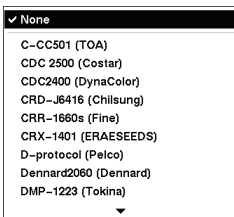

NOTE: You will only be able to set up PTZ devices if the PTZ port is set to RS232 or RS485.

Figure 30 – Camera PTZ setup screen.



Highlight the box in the Product column for the PTZ camera you wish to configure and press the  button. A list of PTZ devices appears. Select your camera from the list and press the  button. You will need to connect the camera to the RS232 or RS485 connector on the back of the DVR following the camera manufacturer's instructions.

You can assign IDs to each camera by highlighting the box under the ID heading and pressing the  button. Change the number by highlighting it and using the Up and Down arrow buttons to increase and decrease the number. The PTZ ID number can be set from 0 to 256.

Highlight the Setup... box and press the  button. The Port Setup window appears.

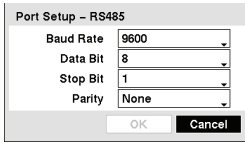

Port Setup - RS485

Baud Rate: 9600

Data Bit: 8

Stop Bit: 1

Parity: None

OK Cancel

Configure the port's setting based on the PTZ camera manufacturer's instructions.

Audio

Highlight Audio in the Devices menu and press the  button. The Audio setup screen appears.

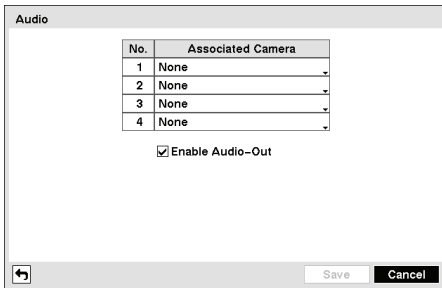



Audio

No.	Associated Camera
1	None
2	None
3	None
4	None

Enable Audio-Out

Save Cancel

The DVR can record up to four audio inputs. Highlight the box beside the input and press the  button. A list of cameras appears, and you can select which camera you want associated with that audio input.

Highlight Enable Audio-Out and press the  button. This toggles between enabling and disabling audio out.

NOTE: The DVR will NOT record audio when the recording speed is set to less than 1 ips.

Figure 31 — Audio setup screen.

Alarm-Out

Highlight Alarm-Out in the Devices menu and press the  button. The Alarm-Out screen allows you to change the settings and establish a schedule for the alarm output from the DVR.

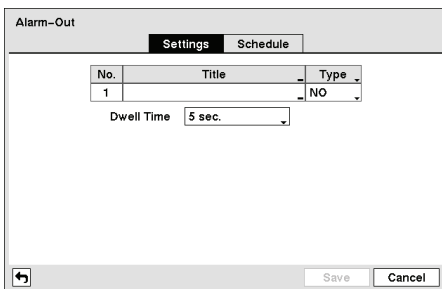

Alarm-Out

Settings Schedule

No.	Title	Type
1		NO

Dwell Time: 5 sec.

Save Cancel

The alarm output can be given its title by highlighting the box under the Title heading and pressing the  button. A virtual keyboard appears allowing you to enter the title.

Highlighting the box under the Type heading allows to set the alarm output for NO or NC (normally open or normally closed).

Highlighting the box beside Dwell Time and pressing the  button allows you to set the dwell time of the alarm output. Dwell times range from 5 seconds to 15 minutes.

Figure 32 — Alarm-Out Settings setup screen.

Highlight the Schedule tab, and the Alarm-Out Schedule setup screen displays.

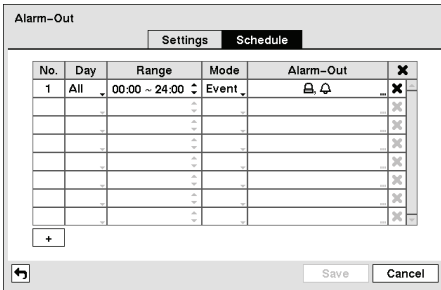

Figure 33 – Alarm-Out Schedule setup screen.

The **Range** box allows you to set the time that the alarm schedule will be active in 15-minute increments from 00:00 to 24:00.

The **Mode** box allows you to set how the alarm reacts during the scheduled time. When set to **On**, the Alarm-Out is active during the scheduled time. When set to **Event**, the Alarm-Out is only active when there is an Event during the scheduled time.

The **Alarm-Out** box allows you to select between Alarm Output and Beep (DVR's internal buzzer).

The **X** box allows you to delete an alarm output schedule. You will be asked to confirm whether or not you really wish to delete the schedule.

Display

Highlight **Display** in the **Devices** menu and press the button. The **Display** screen allows you to select what information will be displayed on the monitor.

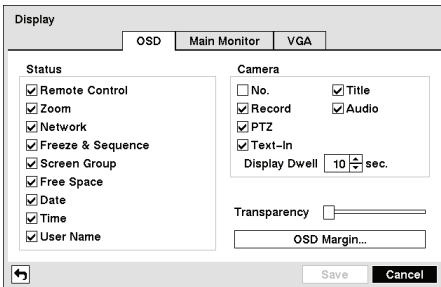





Figure 34 – Display OSD setup screen.

- **Remote Control** – The icon displays when the DVR can be controlled by the infrared remote control.
- **Zoom** – The icon displays on the enlarged video.
- **Network** – The icon displays when the unit is connected to a network via Ethernet. The icon displays when audio communication is available between the DVR and a PC running RAS via Ethernet.
- **Freeze & Sequence** – The icon displays while in the Freeze mode, and the icon displays while in the Sequence mode.

You can add and edit alarm output schedules on this screen. Highlight the **+** and press the button to add a schedule. Highlighting the boxes under the **Column** heading and pressing the button allows you to edit the information in those boxes.

The **Day** box allows you to select the days that the alarm schedule will be active. The choices are: Sun, Mon, Tue, Wed, Thu, Fri, Sat, M~F, Hol and All.

Highlighting an item and pressing the button toggles that item On and Off. When an item is On, there is a checkmark in the box beside it. The following items can be turned On or Off:

- **Screen Group** – The number of screen group displays when the DVR is not in the 3x3 and 1+7 modes of the 8-channel DVR, and 2x2 mode for the 4-channel DVR.
- **Free Space** – The icon  displays when the DVR is in the Recycle mode, and the percentage of available storage space displays when the DVR is not in the Recycle mode.
- **Date/Time** – The current date and time information displays.
- **User Name** – The name of the current user logged in displays.
- **Camera No.** – The camera number displays at the top-left corner of each camera screen.
- **Camera Title** – The camera title displays at the top-left corner of each camera screen.
- **Record** – The record related icons display on each camera screen.
- **Audio** – The icon  displays when the DVR can play live audio.
- **PTZ** – The icon  displays on each PTZ camera screen.
- **Text-In** – The text input strings display on the screen. You can adjust the Display Dwell time (sec.) for the text input strings displayed on the screen.

You can adjust the transparency of the setup screens by highlighting **Transparency** and using the Left and Right arrow buttons.

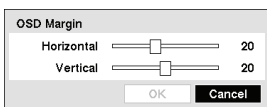

Highlighting **OSD Margin...** and pressing the  button displays how OSD text will be displayed on the monitor. You can adjust the horizontal and vertical margins so that text and icons will not be hidden beyond the edges of the monitor.

Highlight the **Main Monitor** tab, and the **Main Monitor** setup screen appears.

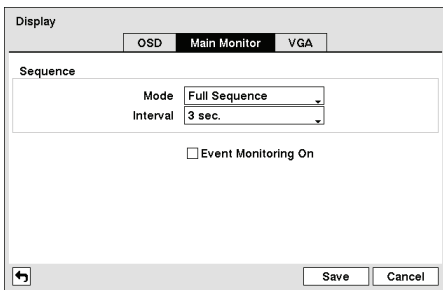



Figure 35 – Main Monitor setup screen.

Highlight the box beside **Mode** and press the  button. You can select between **Full Sequence** and **Cameo Sequence**. (8-ch Model Only)

Pressing the **MENU** button on the front panel for three seconds or longer or the **SEQUENCE** button on the remote control causes the DVR to sequence cameras, and the DVR can sequence cameras in two modes: “Full” and “Cameo”. In the Full mode, the DVR sequences through the cameras and displays them full screen. In the Cameo mode, the bottom right window in a multi-screen format sequences through the cameras.

NOTE: Any cameras that are Off, have lost video or are set to Covert (unless the user has authority to view covert cameras) will be excluded from the Cameo sequence.

You can define the screen layout in a variety of formats and set the DVR to sequence through the different screen layouts (pages) so that all the cameras will be displayed. You can also set up the DVR to display one camera or a group of cameras all the time while cycling through the remaining cameras in a “cameo” window. This can be done with one camera displayed full screen while displaying the cameo window as a PIP (picture in picture), or displaying the cameras in a grid pattern with the bottom right window as the cameo.

NOTE: Sequence cannot be used in the 3x3 and 1+7 modes of the 8-channel DVR, and 2x2 mode of the 4-channel DVR.

You can adjust the display dwell time by highlighting the box beside Interval and pressing the  button. You can select dwell intervals ranging from 1 second to 1 minute.

Highlight Event Monitoring On and press the  button. Pressing the  button toggles between On and Off. When it is On, the DVR will display the camera associated with the event when an event occurs.

Highlight the VGA tab, and the VGA setup screen appears.

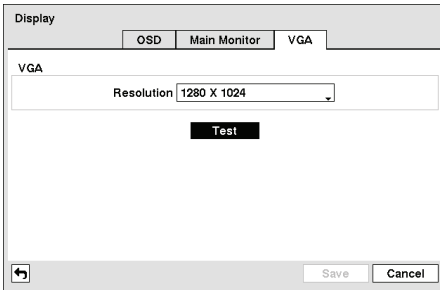

Highlight the box beside Resolution and press the  button. You can select from 800x600, 1024x768 and 1280x1024.



Highlight the box Test box and press the  button to test how the screen will be displayed with the resolution you set.

Figure 36 – VGA setup screen.

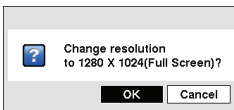

Highlighting OK and pressing the  button applies resolution changes.

Remote Control

Highlight Remote Control in the Devices menu and press the  button. The Remote Control setup screen allows you to select a port and make correct settings for a remote keyboard.



Highlight the box beside Port and select between None, RS232 and RS485. If the RS232 port and RS485 port is in use for PTZ control, networking or text input, the remote keyboard cannot be configured.

Highlight Setup... and select the correct Baud Rate, Parity, Data Bits and Stop Bits for the device you are connecting to the DVR.

Highlight the box beside Remote Control Product and select the device from the list.

Figure 37 – Remote Control setup screen.

Recording Setup

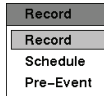

Figure 38 — Record menu.

Record

Highlight Record in the Record menu and press the button. The Record setup screen appears.

 The Record setup screen has a title bar with 'Record' and two tabs: 'Settings' and 'Panic Record'. The 'Settings' tab is active. It contains the following controls:

- Recycle
- Resolution: Standard (dropdown menu)
- Event Record Dwell: 5 sec. (dropdown menu)
- Record Audio
- Auto Deletion: 0 (dropdown menu) Never
- Limit Time-Lapse Recording: Never

 At the bottom, there is a back arrow, a 'Save' button, and a 'Cancel' button.

Highlighting Recycle and pressing the button toggles between On and Off. In the Recycle mode, the DVR records over the oldest video data once all available storage space has been used. When Recycle is turned off, the DVR stops recording once all available storage space has been used.

Highlight the Resolution box and select from Very High, High and Standard.

Figure 39 — Record setup screen.

NOTE: The total ips of all camera channels will be limited to 120 ips (60 ips for 4-ch Model) when set to *High* resolution and 60 ips (30 ips for 4-ch Model) when set to *Very High* resolution.

NOTE: When set to *High* or *Very High* resolution, the maximum recording speed of each camera channel might decrease so as not to exceed the total ips of all camera channels. The 8-channel model DVR has two camera groups (No. 1: cameras 1 to 4 and No. 2: cameras 5 to 8), and setting resolution will be applied to all the cameras within the same camera group. See the table below.

No. of cameras set to <i>On</i> and <i>High</i>				
0	1	2	3	4
—	30 ips	30 ips	20 ips	15 ips

No. of cameras set to <i>On</i> and <i>Very High</i>				
0	1	2	3	4
—	30 ips	15 ips	10 ips	7.5 ips

Highlight the Event Record Dwell box and set the length of time you would like to record for the associated event. You can set the dwell from 5 seconds to 15 minutes. Refer to *Event Actions* screen in this chapter for information regarding event recording.

Highlighting Record Audio and pressing the button toggles between On and Off. When set to On, the DVR will record audio when video is recording.

NOTE: The DVR will NOT record audio when the recording speed is set to less than 1 ips.

Highlight the box beside **Auto Deletion**, and use the Left and Right arrow buttons to adjust the length of time recorded data will be kept from 1 to 999 days. The DVR automatically deletes video recorded earlier than the user-defined period under three conditions: at midnight, whenever the system reboots or whenever the user changes the Auto Deletion settings. Selecting **Never** will disable the Auto Deletion function.

Highlight the slide bar beside **Limit Time-Lapse Recording**, and use the Left and Right arrow buttons to adjust the length of the maximum storage time for time-lapse recording from 1 to 99 days. The Limit Time-Lapse Recording feature will function when the storage device has enough space to record video data longer than the preset period. When this feature is On, the DVR records over the oldest “time-lapse” video once all available storage has been used in the Recycle mode, so more event video can be saved. Selecting **Never** will disable the Limit Time-Lapse Recording function.

NOTE: When the storage device does not have enough space to record video data longer than the preset Limit Time-Lapse Recording period, the DVR records over the oldest video data (time-lapse or event video) as it would in the Recycle mode even if this feature is turned On.

NOTE: The maximum storage time is only an estimate because the amount of space required to store video varies depending on many factors such as motion and image complexity.

Highlight the **Panic Record** tab, and the Panic Record setup screen appears.

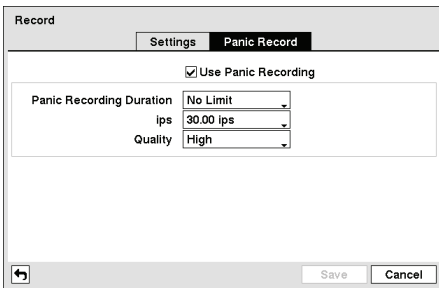





Figure 40 – Record setup screen.

Highlighting **Use Panic Recording** and pressing the  button toggles between On and Off.

Highlight the **Panic Recording – Duration** box and set the duration of panic recording. Panic recording will stop automatically after the preset duration as long as the **PANIC** button is not pressed to stop the panic recording. You can set the dwell from 5 minutes to 1 hour. Select **No Limit** if you want to stop panic recording manually.

Highlighting the **Panic Recording – ips** and pressing the  button allows you to set the images per second for Panic recording. You can select from 1.00 to 30.00 ips (25.00 ips PAL).

Highlighting the **Panic Recording – Quality** and pressing the  button allows you to set the recorded image quality for Panic recording. You can select from: **Very High, High, Standard** and **Basic**.

Schedule

Highlight **Schedule** in the Record menu and press the  button, and the Schedule setup screen appears.

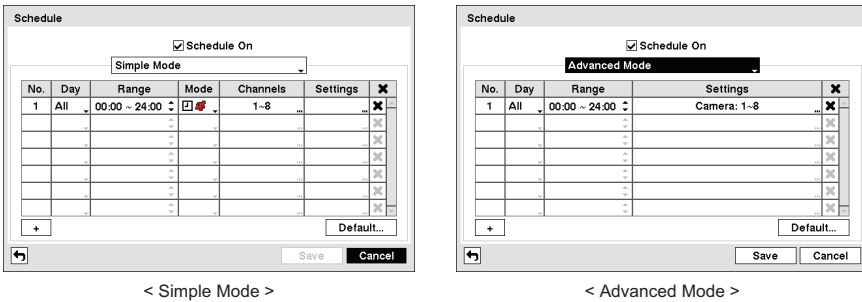







Figure 41 — Schedule setup screen.

You can program the DVR to record only during certain times based on time, day of the week, and holidays. The smallest time segment you can use is 15 minutes.

Highlighting **Schedule On** and pressing the  button toggles between On and Off. In the Schedule On mode, the DVR records video based on the schedule established in the Schedule screen. When turning Schedule recording Off, you will be asked to confirm your decision, and  displays at the top-left corner of each camera screen. Panic recording will function even when Schedule is turned off.  displays during panic recording.

Highlight the **Schedule Mode** box and press the  button. You can select between Simple Mode and Advanced Mode. Selecting Advanced Mode allows you to set up individual recording schedule for each event.



Highlight the **+** and press the  button to add a schedule item.





Highlight the box under the **Day** heading and press the  button to change the days that the scheduled recording will take place. Choose from: Sun, Mon, Tue, Wed, Thu, Fri, Sat, M-F, Hol and All.



Highlight the box under the **Range** heading and press the  button to change the time range that the scheduled recording will take place. The smallest time segment you can use is 15 minutes.

Highlight the box under the **Mode** heading and press the  button to change the recording mode that will be used. Choose from: No Record, Time, Event and Time & Event. (Simple Mode Only)

When the DVR is in the **No Record** mode, it will not record during the preset day and time range as long as the **PANIC** button is not pressed. Use the **No Record** mode when you do NOT want the DVR to record during certain times.

When the DVR is in the **Time** mode, the  icon displays at the top-left corner of the screen. The DVR will record and displays the  icon at the top-left corner of the screen during the scheduled times.

When the DVR is in the **Event** mode, the red  icon displays at the top-left corner of the screen. The DVR will record and displays the  icon at the top-left corner of the screen when any event occurs. When the DVR is in the **Pre-Event** recoding mode, the yellow  icon displays when there is no event, and the DVR is not recording. When the DVR is in the **Pre-Event** mode, the red  and  display when any event occurs and the DVR starts recoding.

When the DVR is in the Time & Event mode, the DVR will follow the Time settings and the  icon displays. The DVR follows the Event settings and the  icon displays.

Highlight the box under the Channels heading and press the  button to select which cameras will be recorded. (Simple Mode Only)

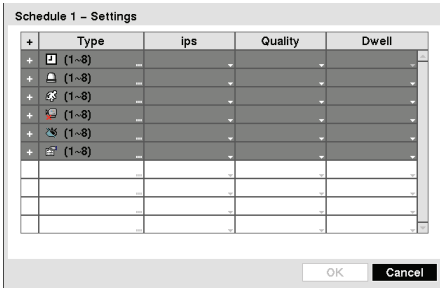



Figure 42 – Schedule – Settings (Advanced Mode) setup screen.

Highlight the box under the Settings heading and press the  button to define the recording settings. You can set the ips and Quality (ips, Quality and Dwell for Advanced Mode setup) of the recording for any modes you set up in the Mode column. If you do not set the ips, Quality and Dwell in the Settings column, the DVR will follow the default settings. See below for details.



NOTE: Descriptions of the Record icons in the Type column are as follows:

-  Time-lapse (Time)  Alarm-In
-  Motion  Video Loss
-  Video Blind  Text-In

NOTE: Day, Range and Channels that are not defined will use the setting values of the previous schedule item.

NOTE: When more than two schedule items are registered in the same day and time range, the DVR will follow the latest registered schedule item.



NOTE: When multiple events are detected at the same time from a specific channel, the DVR will record event video with the high setting values if the ips, Quality, Resolution and Dwell values of events are different from each other. However, the ips will be reset to the supported maximum value when the ips, Quality, Resolution and Dwell are all set to the highest value. (Advanced Mode Only)

Highlight the box under the  heading and press the  button to delete the recording settings. You will be asked to confirm that you want to delete the settings.

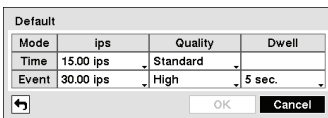
Highlight Default... and press the  button. The Default screen appears.



Highlighting boxes under ips and pressing the  button allows you to set the images per second for Time and Event recording. You can select from 0.10 to 30.0 images per second.

Highlighting boxes under Quality and pressing the  button allows you to set the recorded image quality for Time and Event recording. You can select from: Very High, High, Standard and Basic. Highlighting boxes under Dwell and pressing the  button allows you to set the length of time you would like to record for the associated event. (Advanced Mode Only)

Pre-Event

Highlight Pre-Event in the Record menu and press the  button, and the Pre-Event setup screen appears. If you do not have Event set up in the Record Schedule, a message will display alerting you to this fact.

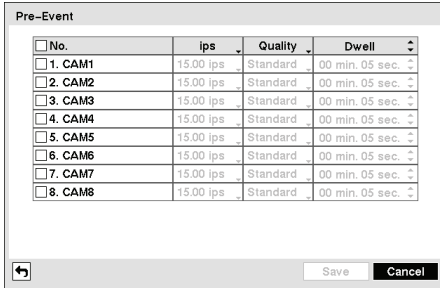

No.	CAM	ips	Quality	Dwell
<input type="checkbox"/>	1. CAM1	15.00 ips	Standard	00 min, 05 sec.
<input type="checkbox"/>	2. CAM2	15.00 ips	Standard	00 min, 05 sec.
<input type="checkbox"/>	3. CAM3	15.00 ips	Standard	00 min, 05 sec.
<input type="checkbox"/>	4. CAM4	15.00 ips	Standard	00 min, 05 sec.
<input type="checkbox"/>	5. CAM5	15.00 ips	Standard	00 min, 05 sec.
<input type="checkbox"/>	6. CAM6	15.00 ips	Standard	00 min, 05 sec.
<input type="checkbox"/>	7. CAM7	15.00 ips	Standard	00 min, 05 sec.
<input type="checkbox"/>	8. CAM8	15.00 ips	Standard	00 min, 05 sec.

Save Cancel

Figure 43 – Pre-Event setup screen.

You can set the amount of time to record prior to the event by adjusting the Dwell. You can set the Dwell from 5 seconds to 30 minutes. The longer the dwell set, the fewer maximum ips can be set.

NOTE: When the DVR is in the Time or Time & Event mode, it ignores the pre-event settings and follows the time settings.

When the DVR is in the Event Record mode it is possible to have it record images before the event occurs. The Pre-Event screen allows you to define how to handle pre-event recording.

You can turn individual cameras On or Off for pre-event recording. The image speed can be set from 0.10 to 30.00 ips (25.00 ips PAL), and image quality can be selectable from Very High, High, Standard and Basic.

Event Setup

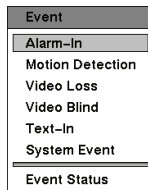

Event
Alarm-In
Motion Detection
Video Loss
Video Blind
Text-In
System Event
Event Status

Figure 44 – Event menu.

Alarm-In

Highlight Alarm-In in the Event menu and press the  button. The Alarm-In setup screen appears.

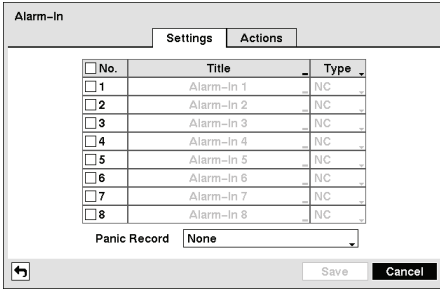

Figure 45 – Alarm-In Settings setup screen.

You can set up the DVR to start panic recording whenever it senses an input on one of its alarm input connectors. Highlight the box beside **Panic Record** and press the button. A list of Alarm Inputs appears, and you can select which alarm input you want associated with panic recording. The DVR will continue panic recording until an input on the selected alarm input is released as long as the **PANIC** button is not pressed to stop the panic recording.

Highlight the **Actions** tab, and the Alarm-In Actions setup screen appears.

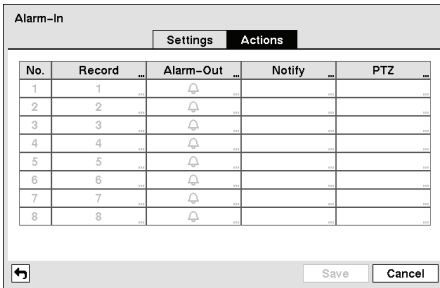

Figure 46 – Alarm-In Actions setup screen.

The alarm terminal strip on the back of the DVR has inputs associated with each alarm. You can set up each input on the **Alarm-In** screen. You can turn each input On or Off by highlighting the alarm number and pressing the button.

Each input can be given a title. Highlight the desired Title box and press the button. A virtual keyboard appears allowing you to enter a title name.

Each input can be set as NO (normally open) or NC (normally closed).

You can set the actions the DVR will take whenever it senses an input on one of its alarm input connectors.

Highlight the desired box under the **Record** heading, and press the button. A list of cameras appears. Select the cameras that you want the DVR to record whenever it detects an input on the associated alarm input.

NOTE: For the Record action, the camera you select should be set to the Event or Time & Event recording mode in the Record Schedule setup screen.

Highlight the desired box under the **Alarm-Out** heading, and press the button. Select between Alarm Output and Beep (DVR's internal buzzer) that you would like to activate and to sound whenever the DVR detects an input on the associated alarm input.

NOTE: For the Alarm-Out action, the alarm output and beep you select should be set to the Event mode in the Alarm-Out setup screen (Schedule tab).

Highlight the desired box under the **Notify** heading, and press the button. The Alarm-In Notify menu appears.

Alarm-In 1 : Notify

Notification

Mail : <None>

LAN 1 : <None>

LAN 2 : <None>



LAN 3 : <None>

LAN 4 : <None>

LAN 5 : <None>

Alert Window

OK Cancel

You can toggle the entire list On and Off by highlighting Notification and pressing the  button. You can toggle the individual items On and Off by highlighting that item and pressing the  button. Highlight OK and press the  button to accept your changes.

NOTE: For the Notify action, the notify item you select should be enabled in the Notification setup screen and the DVR should be registered in the RAS (Remote Administration System).

Highlight the desired box under the PTZ heading, and press the  button. A list of PTZ presets appear. Select the preset position for each PTZ camera, where you want PTZ cameras to move to whenever the DVR detects an input on the associated alarm input.

Motion Detection

Highlight Motion Detection in the Event menu and press the  button. The Motion Detection setup screen appears.

Motion Detection

Settings Actions

<input type="checkbox"/>	No.	Sensitivity ...	Zone	Min. Blocks ...	<input type="checkbox"/> Zone View
<input type="checkbox"/>	1	3 / 3	720 Block(s)	1 / 1	<input type="checkbox"/>
<input type="checkbox"/>	2	3 / 3	720 Block(s)	1 / 1	<input type="checkbox"/>
<input type="checkbox"/>	3	3 / 3	720 Block(s)	1 / 1	<input type="checkbox"/>
<input type="checkbox"/>	4	3 / 3	720 Block(s)	1 / 1	<input type="checkbox"/>
<input type="checkbox"/>	5	3 / 3	720 Block(s)	1 / 1	<input type="checkbox"/>
<input type="checkbox"/>	6	3 / 3	720 Block(s)	1 / 1	<input type="checkbox"/>
<input type="checkbox"/>	7	3 / 3	720 Block(s)	1 / 1	<input type="checkbox"/>
<input type="checkbox"/>	8	3 / 3	720 Block(s)	1 / 1	<input type="checkbox"/>

Motion Ignoring Interval 2 sec. Daytime Setup...

Save Cancel

Your DVR has built-in video motion detection. Video motion detection can be turned On or Off for each camera.

Figure 47 – Motion Detection Settings setup screen.

Motion Detection – Sensitivity

Daytime 3

Nighttime 3

OK Cancel

Highlighting the box under the Sensitivity heading and pressing the  button allows you to adjust the DVR's sensitivity to motion for Daytime and Nighttime independently. There are five settings with 1 being the least sensitive and 5 being the most sensitive.

You can define the area of the image where you want to detect motion; e.g., a doorway. Highlight the box under the Zone heading, and press the  button. The Motion Detection Zone screen displays.

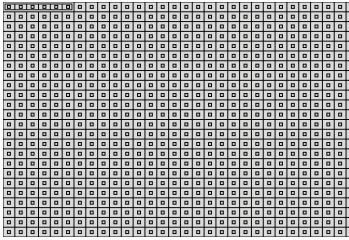

The Motion Detection Zone screen is laid over the video for the selected camera. You can set up motion detection zones by selecting or clearing blocks.

NOTE: You can set up motion zones one block at a time in groups of three or six individual block groups (4- and 8-channel DVR respectively). A block group is positioned within the image area using the Up and Down arrow buttons, and individual blocks within the block groups are selected or cleared using the camera buttons.

Press the  button to display the menu screen. The menu on the setup screen has the following functions:



- Select — Activates highlighted blocks to detect motion.
- Clear — Deactivates highlighted blocks so that they will not detect motion.
- Reverse — Activates inactive highlighted blocks and deactivates active highlighted blocks.
- Select All — Activates all blocks to detect motion.
- Clear All — Deactivates all blocks so that they will not detect motion.
- Reverse All — Activates inactive blocks and deactivates active blocks.
- OK — Accepts changes and closes Zone setup.
- Cancel — Exits Zone setup without saving changes.

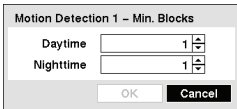

You can adjust the minimum number of detection blocks that must be activated to trigger a motion alarm. Highlighting the box under the Min. Blocks heading and pressing the  button allows you to adjust the minimum number of detection blocks for Daytime and Nighttime independently. Smaller numbers provide greater sensitivity because fewer detection blocks must be activated.

Turning Zone View On will allow you to observe how the DVR is reacting to motion. When in the motion viewing mode, any detected motion within the zone will be displayed in red.

You can control excessive event logging and remote notification of motions detected after the motion dwell time by adjusting the motion ignoring dwell intervals. Highlight the box beside Motion Ignoring Interval and press the  button. A list of intervals ranging from 1 to 10 seconds or Never appears. The DVR will not log and notify motion events occurred during the preset interval range.

NOTE: The record action for motion events will not be affected by the Motion Ignoring function.

Highlighting Daytime Setup and pressing the  button allow you to set up the Daytime range.

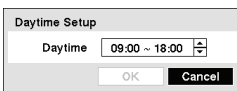

Highlight the box beside Daytime and press the  button. Use the Up and Down arrow buttons to set the Daytime range. The DVR will consider the remaining time range as the Nighttime.

Highlight the Actions tab, and the Motion Detection Actions setup screen appears.

No.	Record	Alarm-Out	Notify	PTZ
1	1	🔔	🔔	...
2	2	🔔	🔔	...
3	3	🔔	🔔	...
4	4	🔔	🔔	...
5	5	🔔	🔔	...
6	6	🔔	🔔	...
7	7	🔔	🔔	...
8	8	🔔	🔔	...

The DVR can be set to react to motion detection differently for each camera. Each camera can be associated with another camera, trigger an Alarm-Out connector, sound the DVR's internal buzzer, notify a number of different devices, and/or move PTZ cameras to preset positions.

NOTE: You can associate multiple cameras with a camera that detects motion.

Figure 48 — Motion Detection Actions setup screen.

Highlight the box under the Record heading and press the button. A list of cameras appears. You can associate as many cameras with that camera as you wish. If the DVR detects motion on the selected camera, it starts recording video from all the associated cameras.

NOTE: For the Record action, the camera you select should be set to the Event or Time & Event recording mode in the Record Schedule setup screen.

Highlight the box under the Alarm-Out heading and press the button. Select between Alarm Output and Beep (DVR's internal buzzer) that you would like to activate and to sound whenever the DVR detects motion on the selected camera's input.

NOTE: For the Alarm-Out action, the alarm output and beep you select should be set to the Event mode in the Alarm-Out setup screen (Schedule tab).

Highlight the box under the Notify heading and press the button. You can toggle the entire list On and Off by highlighting Notification and pressing the button. You can toggle the individual items On and Off by highlighting that item and pressing the button. Highlight OK and press the button to accept your changes.

NOTE: For the Notify action, the notify item you select should be enabled in the Notification setup screen and the DVR should be registered in the RAS (Remote Administration System).

Highlight the desired box under the PTZ heading, and press the button. A list of PTZ presets appear. Select the preset position for each PTZ camera, where you want PTZ cameras to move to whenever the DVR detects motion on the selected camera's input.

Video Loss

Highlight Video Loss in the Event menu and press the button. The Video Loss setup screen appears.

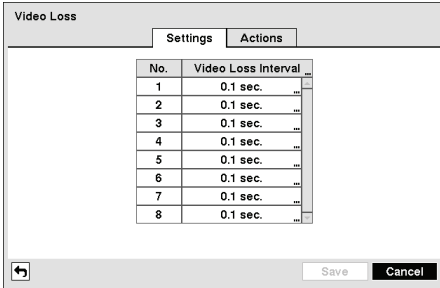

Figure 49 – Video Loss Settings setup screen.

Highlighting the box under the Video Loss Interval heading allows you to set the duration of a signal loss before the DVR will report a Video Loss. The DVR will not consider any signal loss from a camera to be a Video Loss if the detected signal loss is shorter than the interval set on this screen.

Highlight the Actions tab, and the Video Loss Actions setup screen appears.

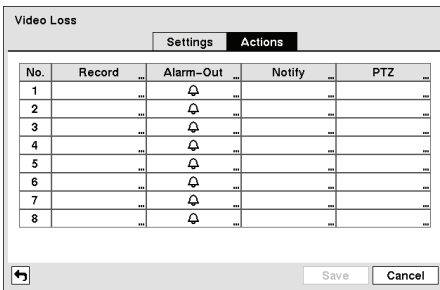

Figure 50 – Video Loss Actions setup screen.

The DVR can be set to react to video loss differently for each camera. Each camera can be associated with another camera, trigger an Alarm-Out connector, sound the DVR's internal buzzer, notify a number of different devices, and/or move PTZ cameras to preset positions.

Highlight the box under the Record heading and press the button. A list of cameras appears. You can associate as many cameras with that camera as you wish. If the DVR detects video loss on the selected camera, it starts recording video from all the associated cameras.

NOTE: For the Record action, the camera you select should be set to the Event or Time & Event recording mode in the Record Schedule setup screen.

Highlight the box under the Alarm-Out heading and press the button. Select between Alarm Output and Beep (DVR's internal buzzer) that you would like to activate and to sound whenever the DVR detects video loss on the selected camera.

NOTE: For the Alarm-Out action, the alarm output and beep you select should be set to the Event mode in the Alarm-Out setup screen (Schedule tab).

Highlight the box under the Notify heading and press the button. You can toggle the entire list On and Off by highlighting Notification and pressing the button. You can toggle the individual items On and Off by highlighting that item and pressing the button. Highlight OK and press the button to accept your changes.

NOTE: For the Notify action, the notify item you select should be enabled in the Notification setup screen and the DVR should be registered in the RAS (Remote Administration System).

Highlight the desired box under the PTZ heading, and press the button. A list of PTZ presets appear. Select the preset position for each PTZ camera, where you want PTZ cameras to move to when the DVR detects video loss on the selected camera's input.

Video Blind

Highlight Video Blind in the Event menu and press the  button. The Video Blind setup screen appears.

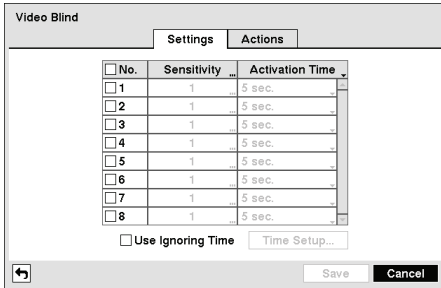



No.	Sensitivity	Activation Time
<input type="checkbox"/> 1	1	5 sec.
<input type="checkbox"/> 2	1	5 sec.
<input type="checkbox"/> 3	1	5 sec.
<input type="checkbox"/> 4	1	5 sec.
<input type="checkbox"/> 5	1	5 sec.
<input type="checkbox"/> 6	1	5 sec.
<input type="checkbox"/> 7	1	5 sec.
<input type="checkbox"/> 8	1	5 sec.

Use Ignoring Time Time Setup...

Save Cancel

Figure 51 – Video Blind Settings setup screen.

Highlighting the box under the Activation Time heading allow you to set the duration before the DVR will report a Video Blind. The DVR will not consider any blindness on camera video to be Video Blind if the blindness does not last during the preset Activation Time after detected.

Highlight Use Ignoring Time and press the  button to toggle between On and Off. When set to On, the DVR will ignore video blind events occurred during the preset period. Highlighting Time Setup and press the  button allows you to set up event ignoring time.

Highlight the Actions tab, and the Video Blind Actions setup screen appears.

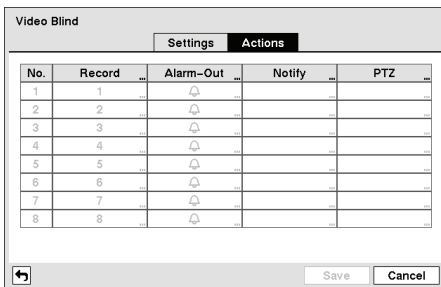

No.	Record	Alarm-Out	Notify	PTZ
1	1			
2	2			
3	3			
4	4			
5	5			
6	6			
7	7			
8	8			

Save Cancel

Figure 52 – Video Blind Actions setup screen.

The DVR checks to see if anything is blinding the camera. Highlighting the box under the Sensitivity heading allows you to adjust the DVR's sensitivity to video blind from 1 (least sensitive) to 15 (most sensitive).

NOTE: The DVR supports both Black Blind and White Blind detection.

NOTE: Video blind might NOT be detected for a camera with a very noisy image especially when set for low sensitivity values.

The DVR can be set to react to video blind differently for each camera. Each camera can be associated with another camera, trigger an Alarm-Out connector, sound the DVR's internal buzzer, notify a number of different devices, and/or move PTZ cameras to preset positions.

Highlight the box under the Record heading and press the  button. A list of cameras appears. You can associate as many cameras with that camera as you wish. If the DVR detects video blind on the selected camera, it starts recording video from all the associated cameras.

NOTE: For the Record action, the camera you select should be set to the Event or Time & Event recording mode in the Record Schedule setup screen.

Highlight the box under the Alarm-Out heading and press the  button. Select between Alarm Output and Beep (DVR's internal buzzer) that you would like to activate and to sound whenever the DVR detects video blind on the selected camera.

NOTE: For the Alarm-Out action, the alarm output and beep you select should be set to the Event mode in the Alarm-Out setup screen (Schedule tab).

Highlight the box under the Notify heading and press the button. You can toggle the entire list On and Off by highlighting Notification and pressing the button. You can toggle the individual items On and Off by highlighting that item and pressing the button. Highlight OK and press the button to accept your changes.

NOTE: For the Notify action, the notify item you select should be enabled in the Notification setup screen and the DVR should be registered in the RAS (Remote Administration System).

Highlight the desired box under the PTZ heading, and press the button. A list of PTZ presets appear. Select the preset position for each PTZ camera, where you want PTZ cameras to move to when the DVR detects video blind on the selected camera's input.

Text-In

Highlight Text-In in the Event menu and press the button. The Text-In setup screen appears.

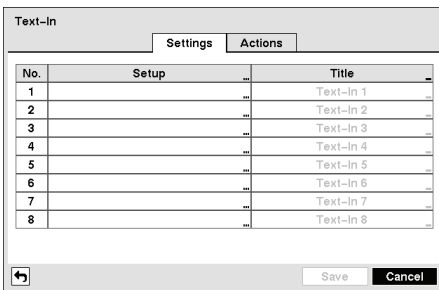

Figure 53 – Text-In Settings setup screen.

The DVR can be set to react to text input from devices such as ATMs (Automated Teller Machines) and POS (Point of Sale; i.e., cash registers). This screen allows you to configure the DVR for each text-in device.

Highlight the box under the Setup heading, and press the button. Selecting the Setup heading changes all the parameters excluding Port settings of all the text input channels.

NOTE: The system performance might be affected when a large quantity of text inputs are detected from several channels at the same time.

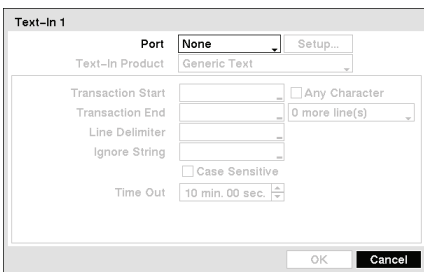

Figure 54 – Text-In Device setup screen.

Highlight the box beside Port, and press the button. Select from None, RS232, RS485, USB-Serial (1~8) and LAN (1~8).

NOTE: If you have set the Port as None, you will not be able to make any changes to the screen.

NOTE: When using the USB to serial text-in device, do NOT remove the USB cable from the port while the system is running.

Highlight Setup..., and press the button. Use the ATM or POS manufacturer's recommended settings when configuring the RS232, RS485, USB-Serial or LAN ports.

Highlight the box beside Text-In Product, and press the button. Select your device from the list.

NOTE: The following description is for a *Generic Text Device*. The screen changes for different types of text input devices, and there will be different parameter boxes for you to enter information.

Highlight the box beside **Transaction Start**, and press the  button. Use the virtual keyboard to enter the Transaction Start string. Refer to the device manufacturer's documentation for the text string that the device first sends when a transaction starts.

If you want the DVR to react to any character sent from the text input device, you will want to turn **On Any Character**. Highlight **Any Character**, and press the  button to toggle between On and Off.

NOTE: If *Any Character* is turned On, you will not be able to enter any text in the *Transaction Start* box.

Highlight the box beside **Transaction End**, and press the  button. Use the virtual keyboard to enter the Transaction End string. Refer to the device manufacturer's documentation for the text string that the device sends when a transaction ends.

Highlight the **more line(s)** box, and press the  button. Select the number of additional lines of text that you want the DVR to record. You can choose from 0 to 10.

Highlight the box beside **Line Delimiter**, and press the  button. Use the virtual keyboard to enter the character(s) that the device uses to indicate the end of a line. Special characters can be created using ^ and a capital letter; e.g., ^J for NL (New Line), ^M for CR (Carriage Return). Refer to the device manufacturer's documentation for Line Delimiter character(s).

Highlight the box beside **Ignore String**, and press the  button. Use the virtual keyboard to enter any strings of text that you want the DVR to ignore. Refer to the device manufacturer's documentation for text strings that the device sends during transactions, so you will know which ones you do not want recorded.

Highlight the **Case Sensitive** box, and press the  button to toggle between On and Off. Refer to the device manufacturer's documentation to determine if the text strings are Case Sensitive. If the device distinguishes between upper and lower case letters, make certain the **Case Sensitive** box is turned On.

Highlight the box beside **Time Out**, and press the  button. Set the length of time to wait for the new text string. The DVR will consider a transaction complete if no new text strings are entered between the last text input and the dwell time out. You can adjust the Time Out dwell from 5 seconds to 15 minutes.

Highlight the **Actions** tab, and the **Text-In Actions** setup screen appears.

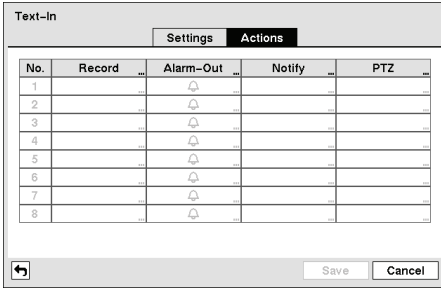

Figure 55 – Text-In Actions setup screen.

The DVR can be set to react to text input. Text input can be associated with cameras, trigger an Alarm-Out connector, sound the DVR’s internal buzzer, notify a number of different devices, and/or move PTZ cameras to preset positions.

Highlight the box beside Record and press the button. A list of cameras appears. You can associate as many cameras with the Text Input as you wish. If the DVR detects text input, it starts recording video from all the associated cameras.

NOTE: For the Record action, the camera you select should be set to the Event or Time & Event recording mode in the Record Schedule setup screen.

Highlight the box under the Alarm-Out heading and press the button. Select between Alarm Output and Beep (DVR’s internal buzzer) that you would like to activate and to sound whenever the DVR detects text input.

NOTE: For the Alarm-Out action, the alarm output and beep you select should be set to the Event mode in the Alarm-Out setup screen (Schedule tab).

Highlight the box beside Notify and press the button. You can toggle the entire list On and Off by highlighting Notification and pressing the button. You can toggle the individual items On and Off by highlighting that item and pressing the button. Highlight OK and press the button to accept your changes.

NOTE: For the Notify action, the notify item you select should be enabled in the Notification setup screen and the DVR should be registered in the RAS (Remote Administration System).

Highlight the desired box under the PTZ heading, and press the button. A list of PTZ presets appear. Select the preset positions for each PTZ camera, where you want PTZ cameras to move to when the DVR detects text input.

System Event

Highlight System Event in the Event menu and press the button. The System Event setup screen appears.

Check Alarm-In	Interval
Alarm-In 1	Never
Alarm-In 2	Never
Alarm-In 3	Never
Alarm-In 4	Never

Figure 56 — Health Check setup screen.

The DVR can be configured to run self-diagnostics and report the results.

Highlighting the box beside System and pressing the button allows you to select the interval that you want the DVR to run self-diagnostics on the system. You can select from 1 hr. to 30 days or Never.

No.	Day	Range	Interval	X
1	All	00:00 ~ 24:00	1 min.	X
				X
				X
				X
				X
				X
				X
				X

Highlight the Setup... box beside Check Recording and press the button. The Check Recording screen appears.

Highlighting Schedule On and pressing the button toggles On and Off. When set to On, you can select the day, time range and interval that you want the DVR to run self-diagnostics on the recorder. The Interval can be selectable from 1 min. to 7 days or Never. The box allows you to delete a check recording schedule.

Highlighting the box under the Interval heading beside each alarm-in and pressing the button allows you to change the interval that you want the DVR to run self-diagnostics on Alarm Inputs. You can select from 1 hr. to 30 days or Never.

Highlight the Storage tab and the Storage setup screen displays.

Highlight the box beside Disk Bad Notify, and press the button. Select percentage level of bad disk sectors at which you want the DVR to trigger an alert. Percentage levels range from 10% to 90%.

Highlight the box beside Disk Almost Full Notify, and press the button. Select the percentage level of disk usage at which you want the DVR to trigger an alert. Percentage levels range from 80% to 99%.

Figure 57 — Storage setup screen.

Highlight the first box beside Disk S.M.A.R.T., and press the button. Use the Up and Down arrow buttons to scroll through the numbers. Refer to the hard disk drive manufacturer's documentation for the correct temperature setting. If the temperature of hard disk drive exceeds the defined threshold, the system triggers an alert.

Highlight the second box beside Disk S.M.A.R.T., and press the  button. Select either °C (Celsius) or °F (Fahrenheit), and press the  button.

Highlight the Actions tab and the System Event Actions setup screen displays.

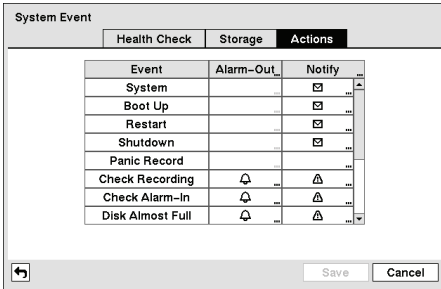







Figure 58 – System Event Actions setup screen.

The DVR can be set to react to system events. System events can activate the Alarm-Out connector, sound the DVR's internal buzzer, and/or notify a number of different devices.

Highlight the Alarm-Out box beside the desired event (Check Recording, Check Alarm-In, Disk Almost Full, Disk Full, Disk Bad, Disk Temperature, Disk S.M.A.R.T. or Disk Config Change), and press the  button. Select between Alarm Output and Beep (DVR's internal buzzer) that you would like to activate and to sound whenever the DVR detects an event.

NOTE: *Alarm-Out* action cannot be set to *System*, *Boot Up*, *Restart*, *Shutdown* and *Panic Record* events.

Highlight the Notify box beside the desired event (System, Boot Up, Restart, Shutdown, Panic Record, Check Recording, Check Alarm-In, Disk Almost Full, Disk Full, Disk Bad, Disk Temperature, Disk S.M.A.R.T. or Disk Config Change), and press the  button. You can toggle the entire list On and Off by highlighting Notification and pressing the  button. You can toggle the individual items On and Off by highlighting that item and pressing the  button. Highlight OK and press the  button to accept your changes.

NOTE: *Mail* notify is the only option available for the *System* event.

NOTE: For the Notify action to work, the DVR should be registered in the RAS (Remote Administration System).

Event Status

Highlight Event Status in the Event menu and press the  button. The Event Status setup screen appears.

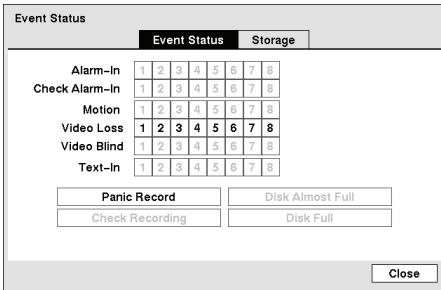

Figure 59 — Event Status setup screen.

Check Alarm-In and Check Recording will be highlighted when each event is detected based on the settings you made in the System Event setup screen on the Event menu.

Panic Record will be highlighted while the DVR is in the panic recording mode.

Disk Almost Full will be highlighted when the DVR is not in the Recycle mode and the level of disk usage reaches the Disk Almost Full percentage you made in the System Event setup screen on the Event menu. Disk Full will be highlighted when the DVR is not in the Recycle mode and all available storage space has been used.

Highlighting the Storage tab will display the hard disk drive status. Refer to the Storage section for details.

The Event Status screen displays the status of the DVR's systems and inputs. Events will be highlighted, and related channels or events will flicker for five seconds when detected.

Alarm-In, Motion, Video Loss, Video Blind and Text-In will be highlighted when each event is detected based on the settings you made in the Alarm-In, Motion Detection, Video Loss, Video Blind and Text-In setup screen on the Event menu.

Chapter 4 – Operation

NOTE: This chapter assumes your DVR has been installed and configured. If it has not, please refer to Chapters 2 and 3.

The DVR's controls are similar to a VCR. As with a VCR, the main functions are recording and playing back video. However, you have much greater control over recording and playing back video. You can establish recording schedules based on time of day and day of the week. The DVR allows you to search through the recorded video using much more sophisticated tools than those available with VCRs. Additional DVR features that are not available with VCRs are remote control and viewing, and recording video at the same time you are watching previously recorded video.

The front panel controls are described in *Chapter 3 – Configuration*.

Turning on the Power

Once you have installed the DVR following the instructions in *Chapter 2 – Installation*, it is ready to record.

Live Monitoring

As soon as the DVR completes its initialization process, it will begin showing live video on the attached monitor and playing live audio through the attached speaker. The default mode is to display all cameras at once. Pressing any camera button will cause that camera to display full screen. It displays live video and plays live audio until the user enters another mode.

While in the live monitoring mode, pressing the **MENU** button displays the following Live Monitoring menu at the top of the screen. Pressing the **MENU** button again hides the menu. You can navigate through menus and items by pressing the arrow buttons.







- ① Freeze
- ② Sequence
- ③ Camera Menu
- ④ Alarm
- ⑤ Panic
- ⑥ Setup
- ⑦ Search Mode
- ⑧ Login/Logout

Figure 60 – Live Monitoring menu.



NOTE: The Live Monitoring menu also can be displayed by moving the mouse pointer to the top of the screen.

Live Monitoring Menu

Freeze

Selecting  (Freeze) in the Live Monitoring menu will freeze the current image on the screen until you select  again. It is the same as pressing the  (Play/Pause) button on the front panel. While in the Freeze mode, the icon  displays in bottom-left corner if Freeze is selected in the Display setup screen (OSD tab).

Sequence



Selecting  (Sequence) in the Live Monitoring menu causes the cameras to display sequentially. It is the same as pressing and holding the **MENU** button on the front panel for three seconds or longer. When in one of the multiview formats, selecting *Sequence* will cause the DVR to go through predefined screen layouts (Full Sequence). Or, the bottom, right screen will display live cameras sequentially (Cameo Sequence). For example, if you select the  icon in the 2x2 format, the 8-channel DVR changes pages as follows:

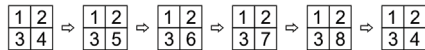

Full Sequence



Cameo Sequence

Selecting  again in the Live Monitoring menu exits the Sequence mode. While in the Sequence mode, the  icon displays in bottom-left corner if Sequence is selected in the Display setup screen (OSD tab). If all the cameras in a page are Off, or have lost video or are set to Covert (unless the user has authority to view covert cameras), that page will be excluded from the sequence.

NOTE: The *Full Sequence* for the full sequence monitoring and the *Cameo Sequence* for the cameo sequence monitoring should be selected in the Display setup screen (Main Monitor tab).

Camera Menu

Selecting  (Camera Menu) in the Live Monitoring menu displays the following Camera Menu.

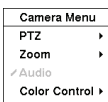

- **PTZ:** Selecting PTZ and choosing the camera number allows you to control the selected camera as long as it has Pan, Tilt and Zoom capabilities. It is the same as pressing and holding the **PTZ** button on the front panel for three seconds or longer. Refer to the following *PTZ Mode* section for details.
- **Zoom:** Selecting Zoom and choosing the camera number zooms the current image of the selected camera on the screen. It is the same as pressing the **Zoom** button on the front panel. Selecting Zoom again in the Camera Menu again exits the Zoom mode. Refer to the following *Zoom Mode* section for details.
- **Audio:** Selecting Audio toggles audio output On and Off.
- **Color Control:** Selecting Color Control and choosing the camera number allows you to control brightness, contrast, hue and saturation for each camera for the selected camera if a user who has Color Control authority logs into the system. It is the same as pressing and holding a camera button for a few seconds.

NOTE: It is important that cameras and monitors are correctly installed and adjusted prior to making any image adjustments using the DVR's controls.

NOTE: Any image adjustments you make will be applied to both the live video on the monitors and the recorded video.

NOTE: The *Camera Menu* also can be displayed by clicking the right mouse button on the screen while in the live monitoring mode.



Camera Menu	
PTZ	▶
Zoom	▶
Audio	▶
Color Control	▶
Edit Group	

- **Edit Group:** Selecting **Edit Group** supports the active cameo function. (8-ch Model Only) Select **Edit Group** and choose a camera that you want to change display position (e.g., Camera A). Then, click the right mouse button to display the menu. If you choose another camera in the menu (e.g., Camera B), the screen displays Camera B instead of Camera A. Clicking the right mouse button and selecting **Exit Group Edit** in the menu exits the Active Cameo mode. Refer to the following *Active Cameo Mode* section for details.

Alarm

Selecting  (Alarm) in the Live Monitoring menu resets the DVR's outputs including the internal buzzer during an alarm. It is the same as pressing any button on the front panel when the alarm is activated.

Panic

Selecting  (Panic) in the Live Monitoring menu starts panic recording of all cameras, and displays  on the screen. Selecting  again stops panic recording. It is the same as pressing the **PANIC** button on the front panel.



Setup

Selecting  (Setup) in the Live Monitoring menu enters the Main Setup screen. Refer to *Chapter 3 – Configuration* for detailed descriptions of system setup.



Search Mode

Selecting  (Search Mode) in the Live Monitoring menu exits the live monitoring mode and enters the search mode. It is the same as pressing the **SEARCH** button on the front panel.

Login/Logout



Selecting  (Login) in the Live Monitoring menu accesses the Login screen, and you will be asked to select a User and enter the password to log into the system. Selecting  (Logout) in the Live Monitoring menu displays the Logout screen asking you to confirm whether or not you want to log out the current user.

Active Cameo Mode

You can enter the Active Cameo mode by pressing the  (Enter) button on the remote control or selecting **Edit Group** in the Camera Menu displayed when clicking the right mouse button in any multi-view format. (8-ch Model Only) The yellow outline surrounding the video indicates the active cameo, and pressing the arrow buttons moves the active cameo. Pressing the  (Enter) button or selecting **Exit Group Edit** in the Camera Menu exits the Active Cameo mode. The active cameo mode will remain in effect for 15 seconds if there is no further operation.

In active cameo mode, press the button for the camera you want to display in the active cameo. After setting the camera number to active cameo, the DVR moves the active cameo to the next cameo. When the camera number exists on the current screen, the active cameo is changed with the existing camera number. When the camera number does not exist on the current screen, the active cameo is replaced by the camera number. You can change the screen layout in this way.

Zoom Mode

You can enlarge an area of the video by selecting **Zoom** from the Camera Menu in the Live Monitoring menu or pressing the **ZOOM** button on the front panel. For a few seconds after selecting **Zoom** from the Camera Menu or pressing the **ZOOM** button, a rectangle displays on the screen. A rectangle shows the area that will be enlarged. You can move the rectangle around using the arrow buttons. Pressing the  (Play/Pause) button in the Zoom mode enlarges the area in rectangle. Exit the Zoom mode by selecting **Zoom** again from the Camera Menu or pressing the **ZOOM** button again. While in the Zoom mode, the icon  displays if **Zoom** is selected in the Display setup screen (OSD tab).

Event Monitoring

When an event occurs, the DVR will display the camera associated with the event if **Event Monitoring On** is selected in the Display setup screen (Main Monitor tab).

How the cameras are displayed depends on the number of cameras associated with the event. If one camera is associated with the event, the DVR will display the camera full screen. If two to four cameras are associated with the event, the DVR will display the cameras on a 2x2 screen. If five to eight cameras are associated with the event, the DVR will display the cameras on a 1+5, 1+7 or 3x3 screen.

Event monitoring lasts for the dwell time set for event recording. After the dwell time has elapsed, the monitor returns to the previous screen unless another event has occurred. If you want to return to the live monitoring mode before the dwell time has elapsed, press one of the camera buttons.

Covert Camera

If a camera is set up as **Covert 1** in the Camera setup screen (Settings tab), that camera will not be displayed unless a user with **Covert Camera View** authority logs into the system. However the camera title and status icons will be displayed on the monitor.

If a camera is set up as **Covert 2** in the Camera setup screen (Settings tab), that camera appears to be **Off** unless a user with **Covert Camera View** authority logs into the system. The camera title will be grayed out and status icons will not be displayed on the monitor.

NOTE: When a camera is set up as Covert 1, the DVR displays the camera title and status icons on the covert video. When set up as Covert 2, the DVR displays only the camera title on the covert video.

If a user who has **Covert Camera View** authority logs into the system, the user can view video from cameras set to **Covert 1** or **Covert 2** including the camera titles and status icons.

PTZ Mode

If a user who has PTZ Control authority logs into the system, the user can control PTZ cameras. The DVR will control cameras with Pan, Tilt and Zoom capabilities. Select PTZ from the Camera Menu in the Live Monitoring menu or press and hold the **PTZ** button on the front panel for three seconds or longer to display the PTZ camera menu and enter the PTZ mode. Select PTZ again from the Camera Menu or press and hold the **PTZ** button for three seconds or longer again to exit the PTZ mode.

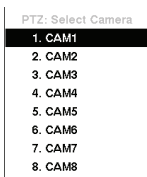

Select the PTZ camera you wish to control. The icon **PTZ** flickers on the PTZ camera screen. You can control the camera using front panel control buttons, by setting up presets or by selecting the expanded PTZ features. To use the front panel buttons, press the Left and Right arrow buttons to pan left and right. Press the Up and Down arrow buttons to tilt the camera up and down. Press the camera button 1 to zoom in, and press the button 2 to zoom out. You can use the button 3 and button 4 to focus the image.

Figure 61 – PTZ Select Camera menu.

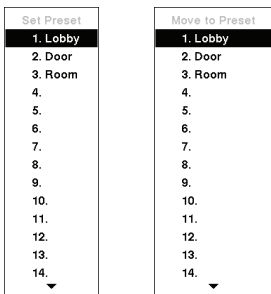

You can save camera position settings as “presets” so that you can go directly to desired views.

Once you have the camera at the desired settings, press the **SEARCH** button on the front panel. Select Set Preset from the Move to Preset dialog box, and the PTZ Preset dialog box will appear. Select the number you want to assign to the preset and press the **⏮** (Play/Pause) button. Use the virtual keyboard to enter the preset name.

Press the **SEARCH** button on the front panel to load the PTZ preset, and the Move to Preset dialog box will appear. Select the desired preset and press the **⏮** button to load the preset.

< Set Preset > < Move to Preset >

Figure 62 – PTZ Preset screen.

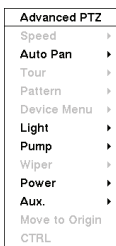

While in the PTZ mode, pressing the **MENU** button and selecting **Q** (Advanced PTZ) in the menu displaying at the top of the screen displays the Advanced PTZ menu.

Set the feature you wish to control by selecting it from the menu. Refer to the camera manufacturer’s instructions for the proper settings. Depending on the camera specifications, some features may not be supported.

You can use a mouse for convenient PTZ control. Position the mouse pointer at the bottom of the screen, and the following PTZ toolbar will display.



Clicking **X** on the left side exits the toolbar. If you want to display the toolbar again, position the mouse pointer at the bottom of the screen. Change the toolbar location by clicking the empty space on the left side of the toolbar and drag it to where you want it located on the screen. Use the arrow buttons on the toolbar to pan or tilt the camera in the direction you want. The other controls on the toolbar perform as described below:

- Zoom In / Out
- Focus Near / Far
- Iris Open / Close
- Set / Load Preset

Using a Mouse

You can use a mouse instead of the front panel buttons to perform many of the DVR functions. In the Live Monitoring mode or Search mode, moving the mouse pointer to the left edge of the screen displays the following Mouse Display menu.



- ① Full Screen
- ② PIP
- ③ 2x2
- ④ 1+5
- ⑤ 1+7
- ⑥ 3x3
- ⑦ Previous Group
- ⑧ Next Group
- ⑨ OSD

Figure 63 — Mouse Display menu.

Full Screen

Selecting (Full Screen) in the Mouse Display menu and choosing the camera number button displays the selected camera full screen. It is the same as pressing the individual camera buttons on the front panel or clicking the left mouse button on a camera image when in one of the multiview formats (i.e., 2x2, 1+5, 1+7 or 3x3). Clicking the left mouse button on the screen again returns to the previous display mode.

PIP, 2x2, 1+5, 1+7, 3x3

Selecting , , , or (PIP, 2x2, 1+5, 1+7 or 3x3) in the Mouse Display menu displays the cameras in the selected multiview screen mode (PIP, 2x2, 1+5, 1+7 or 3x3). Selecting each display mode is the same as pressing the **CAMERA** button on the front panel, **LAYOUT** button on the remote control or scrolling the mouse wheel up and down when in one of the multiview formats (i.e., 2x2, 1+5, 1+7 or 3x3).

NOTE: The PIP, 1+5, and 1+7 display modes will not be supported in the search mode.

NOTE: In the 1+5 or 1+7 display mode, the main channel indicates the channel displayed on the large screen which is displayed in the top-left. You can select the camera you want to display on the main channel screen. Select a channel on the screen and click the right mouse button to display the Camera Menu. Selecting *Go To Main* swaps the selected channel with the main channel. This function is supported only in the 1+5 and 1+7 display modes and can be activated from any of channel screens except the main channel screen.

You can change the location of the PIP (Picture-in-Picture) counterclockwise or clockwise by pressing the Up and Down arrow buttons, and change its size by pressing the Left and Right arrow buttons. To change its location and size by using the mouse, select the PIP and then click the right mouse button to display the following menu. Select the options you want. You can also change the location of the PIP by clicking the left mouse button on the PIP window and dragging it to where you want it located, and change the size of the PIP by clicking the left mouse button at the corner of the PIP window and dragging it until it is the desired size.



Previous Group, Next Group

Selecting or (Previous Group or Next Group) in the Mouse Display menu moves to the previous or next page.

OSD

Selecting (OSD) in the Mouse Display menu toggles OSD On and Off.

Recording Video

Once you have installed the DVR following the instructions in *Chapter 2 — Installation*, it is ready to record. The DVR will start recording based on the settings you made in the Record setup screen. See *Chapter 3 — Configuration*.

Recycle On or Recycle Off. The factory default is **Recycle On**. It does this by recording over the oldest video once the hard disk is full. Setting the DVR to **Recycle Off** causes it to stop recording once the hard disk is full.

Standard (CIF), High (Half D1) or Very High (D1). The factory default resolution is **Standard**. When set to **Standard**, the DVR has a maximum recording speed of 240 ips (120 ips for 4-channel model). When set to **High**, the DVR has a maximum recording speed of 120 ips (60 ips for 4-channel model). When set to **Very High**, the DVR has a maximum recording speed of 60 ips (30 ips for 4-channel model).

Pressing the button starts panic recording of all cameras, and pressing the button again stops panic recording. If you set the Panic Recording Duration in the Record Screen, panic recording will stop automatically according to the preset duration as long as the button is not pressed.

NOTE: When the DVR is not in the **Recycle** mode and all available storage space has been used, panic recording will not operate.

Although you will be able to record without changing the unit from its original factory settings, you will want to take advantages of the DVR's many tools. See *Chapter 3 – Configuration* for detailed descriptions of the recording mode options.

Recording Audio

If the DVR was set up to record audio, it will record audio from up to four inputs when video is recording. The DVR will not record audio when the recording speed is set to less than 1 ips.





NOTE: Make certain you comply with all local and federal laws and regulations when recording audio.

Playing Recorded Video



If a user who has Search authority logs into the system, the user can view recorded image. Once video has been recorded, you can view it by pressing the **SEARCH** button. When playing video for the first time, the DVR will display the most recent image. When playing video subsequent times, the DVR will start playing video from the last recalled image. Recorded audio will be played when the DVR displays a camera with recorded audio in full screen mode.

NOTE: Only the administrator and users with Covert Camera View authority can view video from covert cameras. The covert cameras in the playback mode are determined by the current camera settings.

Camera Buttons: Pressing the individual camera buttons will cause the selected camera to display full screen, and pressing the button again toggles between different display formats. The available formats are: PIP, 2x2, 1+5, 1+7 and 3x3.

Arrow Buttons: Pressing the  button plays video backward at high speed. Pressing the button again toggles the playback speed from ,  and . Pressing the  button plays video forward at high speed. Pressing the button again toggles the playback speed from ,  and . When in the pause mode, pressing the  button moves to the next image and pressing the  button moves to the previous image.

Pause Button: Pressing the  button pauses playing video.

Search Button: Pressing the **SEARCH** button enters the search mode, and pressing the button again exits the search mode. When entering the search mode, video is paused. Pressing the  button plays back video at regular speed. The screen displays  when the DVR is in the Pause mode and the screen displays  when the DVR is playing back video.

Zoom Button: Pressing the **ZOOM** button zooms in the current image on the screen. It is the same as selecting ZOOM from the Camera Menu in the Search menu.

You can use a mouse for convenient playback control. Position the mouse pointer on the playback screen, and the following Record Table Search (Compact View Mode) screen will display. The individual controls on the toolbar perform the following functions as described below:

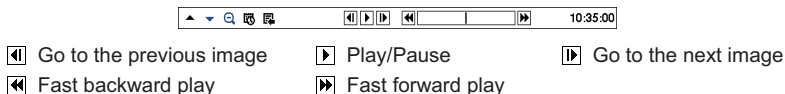

Searching Video

While in the search mode, pressing the **MENU** button displays the following Search menu at the top of the screen. Pressing the **MENU** button again hides the menu. You can navigate through menus and items by pressing the arrow buttons.

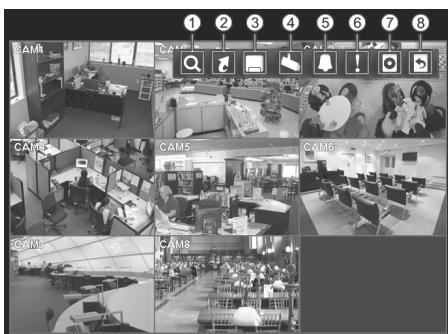

- ① Search
- ② Go To
- ③ Export
- ④ Camera Menu
- ⑤ Alarm
- ⑥ Panic
- ⑦ Data Source
- ⑧ Exit

Figure 64 — Search menu.

NOTE: The Search menu also can be displayed by moving the mouse pointer to the top of the screen.

Search Menu

Search

Selecting **Q** (Search) in the Search menu displays the following Search menu. See the following *Event Log Search*, *Record Table Search*, *Motion Search* and *Text-In Search* sections for details.

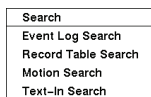

- **Event Log Search:** Selecting Event Log Search selects video from the event log.
- **Record Table Search:** Selecting Record Table Search selects using a recording table.
- **Motion Search:** Selecting Motion Search selects motion events.
- **Text-In Search:** Selecting Text-In Search selects text input strings.

Go To

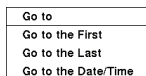

Selecting **f** (Go To) in the Search menu displays the following GO TO menu.

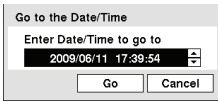

- **Go to the First:** Selecting Go to the First displays the first recorded image.
- **Go to the Last:** Selecting Go to the Last displays the last recorded image.
- **Go to the Date/Time:** Selecting Go to the Date/Time displays the Go to the Date/Time screen.





Move the cursor over the date and time and press the  (Play/Pause) button. You can use the Left and Right arrow buttons to highlight the year, month, day, hours, minutes and seconds. Use the Up and Down arrow buttons to change to the date and time you want to search for video.

Once you have set the date and time you want, press the  button. Then highlight Go and press the  button. The selected date and time will display. (If no video was recorded during the selected time, a message appears alerting you that no image was recorded at that time.) The  button and arrow buttons can now be used to review the surrounding video.

Export

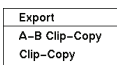
Selecting  (Export) in the Search menu displays the following Export menu. See the following *Clip Copy* section for details.



- **A-B Clip-Copy:** Selecting A-B Clip-Copy will set the starting point of the video to be clip copied, and the  icon displays at the bottom-left corner of the screen. Selecting A-B Clip-Copy again will set the ending point of the video to be clip copied and displays the Clip-Copy screen.
- **Clip-Copy:** Select Clip-Copy, and the Clip-Copy screen appears to allow clip copy setup.

Camera Menu

Selecting  (Camera Menu) in the Search menu displays the following Camera Menu.

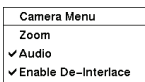

- **Zoom:** Selecting Zoom and choosing the camera number zooms the current playback image of the selected camera on the screen. It is the same as pressing the **ZOOM** button on the front panel. Selecting ZOOM again exits the Zoom mode.
- **Audio:** Selecting Audio toggles audio playback On and Off. Recorded audio will be played when the DVR displays a camera with recorded audio in full screen mode.
- **Enable De-Interlace:** Selecting Enable De-Interlace turns the de-interlace filters on.

NOTE: The video signal has a time difference of 1/60 second (1/50 second for PAL) between odd and even fields because it is composed of 60 interlaced fields per second (50 fields for PAL). When recording video with Very High (D1) resolution, video is made up of frame units combining two fields – one odd field and one even field. This can cause horizontal scan lines or flashes in areas with motion because of the time difference between the two fields. Turning on the de-interlace filter provides clearer video by eliminating these horizontal scan lines and flashes.

NOTE: The *Camera Menu* also can be displayed by clicking the right mouse button on the screen while in the search mode.

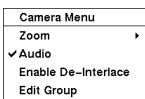



- **Edit Group:** Selecting Edit Group supports the active cameo function. (8-ch Model Only) Select Edit Group and choose a camera that you want to change display position (e.g., Camera A). Then, click the right mouse button to display the menu. If you choose another camera in the menu (e.g., Camera B), the screen displays Camera B instead of Camera A. Clicking the right mouse button and selecting Exit Group Edit in the menu exits the Active Cameo mode. Refer to the *Live Monitoring – Active Cameo Mode* section for details.

Alarm

Selecting  (Alarm) in the Search menu resets the DVR's outputs including the internal buzzer during an alarm. It is the same as pressing any button on the front panel when the alarm is activated.

Panic

Selecting  (Panic) in the Search menu starts panic recording of all cameras, and selecting  again stops panic recording. It is the same as pressing the **PANIC** button on the front panel.

Data Source

Selecting  (Data Source) in the Search menu allows you to select the data source to be searched. Selecting **Record** searches recorded data on primary storage installed in the DVR, and selecting **Other** searches recorded data on storage used for another DVR then installed in this DVR.

Exit

Selecting  (Exit) in the Search menu exits the search mode and enters the live monitoring mode.



Event Log Search

Event Log Search		
Time	Type	Title
2009/06/17 14:44:09	Motion 4	CAM 4
2009/06/17 14:44:09	Motion 1	CAM 1
2009/06/17 14:44:09	Motion 2	CAM 2
2009/06/17 14:44:09	Motion 3	CAM 3
2009/06/17 14:44:09	Motion 4	CAM 4
2009/06/17 14:44:09	Motion 1	CAM 1
2009/06/17 14:44:09	Motion 2	CAM 2
2009/06/17 14:44:09	Motion 3	CAM 3
2009/06/17 14:44:09	Motion 4	CAM 4
2009/06/17 14:44:09	Motion 1	CAM 1
Option...	None	

The DVR maintains a log of each time the Alarm Input port is activated. The Event Log Search screen displays this list. Use the arrow buttons to highlight the event for which you would like to see video.

There is no determined user authority to display the Event Log Search screen, however, the event video will not be played unless a user with Search authority logs into the system.

Figure 65 — Event Log Search screen.

Pressing the  (Play/Pause) button will extract the event video and display the first image of the event. Pressing the  button will start playing the “event” video segment. Pressing **SEARCH** button returns to live monitoring.

NOTE: It is possible that no recorded image displays on the current screen. Change the screen mode to 3x3, for the 8-channel DVR and 2x2 for the 4-channel DVR and you will be able to easily see the cameras that have recorded video during target time.

You can also narrow your event search by selecting the Option... button and setting up the new search condition.

Event Log Search Option			
From	<input checked="" type="checkbox"/> First	2010/06/07 13:58:35	-
To	<input checked="" type="checkbox"/> Last	2010/06/07 13:58:35	-
<input checked="" type="checkbox"/> Check Time Overlap			
Alarm-In	1-8	-	<input checked="" type="checkbox"/> Panic Record
Motion	1-8	-	<input checked="" type="checkbox"/> Check Recording
Video Loss	1-8	-	<input checked="" type="checkbox"/> Check Alarm-In
Video Blind	1-8	-	<input checked="" type="checkbox"/> Disk Almost Full
Text-In	1-8	-	<input checked="" type="checkbox"/> Disk Bad
Record Channels	1-8	-	<input checked="" type="checkbox"/> Disk Temperature
			<input checked="" type="checkbox"/> Disk S.M.A.R.T.

You can search video from the first to last recorded images, or you can set the start and stop times and dates.

Highlight the box beside From and press the  button to toggle between On and Off. When set to Off, you can enter a specific Date and Time. When set to On, the search will be from the first recorded image.

Highlight the box beside To and press the  button to toggle between On and Off. When set to Off, you can enter a specific Date and Time. When set to On, the search will be from the last recorded image.

Highlight the box beside Check Time Overlap and press the  button. It toggles between On and Off. You will only be able to turn the Check Time Overlap on or off if a user-defined date and time is set to From and To. If the DVR's date and time have been reset, it is possible for the DVR to have more than one overlapping start and stop time. When set to On, you will be asked to select one of the overlapping start and stop time. When set to Off, the DVR will display search results from all start times to all stop times.

Highlight the box beside Alarm-In and press the  button. You can select the alarm inputs that you want to include in your search.

Highlight the box beside Motion and press the  button. You can select the cameras for which you want any reports of motion detection.

Highlight the box beside Video Loss and press the  button. You can select the cameras for which you want any reports of lost video.

Highlight the box beside Video Blind and press the  button. You can select the cameras for which you want any reports of blind video.

Highlight the box beside Text-In and press the  button. You can select the text-in devices which you want any report of text input.

Highlight the box beside Record Channels and press the  button. You can select the cameras that you want to search for any reports of event recorded data. The DVR will display the events (not the camera channels) that occurred and that also are recorded on the camera channel that you selected. If you do not select a camera channel in this field, the DVR will search events that are not associated with cameras.

You can also toggle On and Off self-diagnostic events as part of your search. The choices are:

- Panic Record
- Check Recording
- Check Alarm-In
- Disk Almost Full
- Disk Bad
- Disk Temperature
- Disk S.M.A.R.T.

Once you set your desired search conditions, highlight Search and press the \mathcal{V} button to display the search results in the Event Log Search screen. Selecting Cancel exits the screen without saving the changes.

Record Table Search

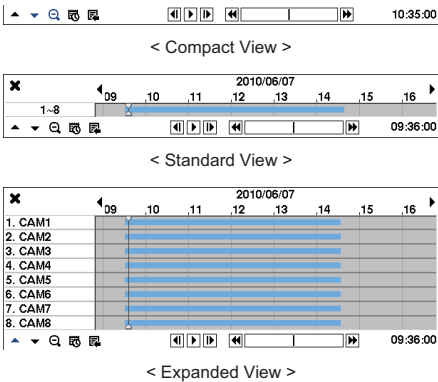

Figure 66 — Record Table Search screen.

Recording information about video images currently displayed on the screen displays on the recording status bar. A grey vertical line indicates the current search position. To search specific video, move the vertical line by using the Left or Right arrow buttons on the front panel or by clicking the mouse on the desired segment.

If the DVR's time and date have been reset to a time that is earlier than some recorded video, it is possible for the DVR to have more than one video stream in the same time range. In this case, the overlapping time range in the record table will be separated by a yellow vertical line.

NOTE: The recorded data in the time range located after the yellow vertical line is the latest.

There are three view modes. Standard view, Expanded view and Compact view. Standard view (default) displays combined recording information of all camera channels currently displayed on the screen. In the Standard view mode, selecting the ▲ icon located at the bottom switches to the Expanded view mode. The Expanded view displays the recording information of each camera channel currently displayed on the screen. Selecting the ▼ icon in the Standard view mode switches to the Compact view mode which displays only the toolbar. Selecting the ▲ icon in the Compact view mode switches to the Standard view mode, and selecting the ▼ icon in the Expanded view mode switches to the Standard view mode.

Selecting \mathcal{Q} or \mathcal{Q} located at the bottom zooms the record table. Selecting \mathcal{Q} displays eight hours (1-minute based), and selecting \mathcal{Q} displays 24 hours (3-minute based) at once. To move to earlier or later times that are not shown in the current record table screen, select the arrows located at the end of the times by using the arrow buttons on the front panel.

NOTE: If the DVR has images recorded in more than one recording mode in the same time range, the recording status bar displays recording information in the following priority order: Panic → Pre-Event → Event → Time. The color of the bar indicates different recording modes: Red for Panic, Yellow for Pre-Event, Purple for Event, and Blue for Time.

Selecting \mathcal{C} located at the bottom displays the Calendar Search screen.

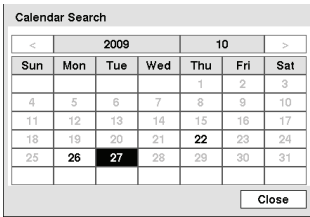

Days with recorded video display on the calendar with white numbers. You can highlight the days with recorded video by using the arrow buttons. Once you have highlighted a day, press the ⏸ (Play/Pause) button to select it. The first recorded image of the selected date will pause on the screen. Once you have selected the date you want to search, review the surrounding video by using the playback controls located at the bottom of the Record Table Search screen.

Selecting  located at the bottom displays the Search menu.

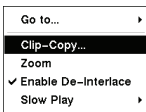





- **Go to:** Displays the first or last recorded image, or searches by date and time (see the previous *Searching Video – Go To* section of this chapter for more details).
- **Clip-Copy:** Clips a video segment and saves it (see the following *Clip Copy* section for more details).

- **Zoom:** Zooms the current playback image.
- **Enable De-Interlace:** Turns the de-interlace filters on.
- **Slow Play:** Plays video at low speed (x1/2, x1/3, x1/4, x1/6 and x1/8).

NOTE: Playing video at low speed will be supported for video recorded 10 images or more per second.

The individual playback controls at the bottom perform the following functions as described below:

-  Go to the previous image
-  Play/Pause
-  Go to the next image
-  Fast backward play
-  Fast forward play

Selecting  in the top-left corner exits the Record Table Search screen.

Motion Search

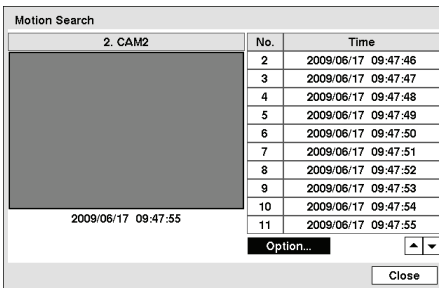

The Motion Search... can be selected from the Search menu while the DVR displays the camera full screen. The Motion Search screen displays a list of motion events. Use the arrow buttons to highlight the event for which you would like to see video and press the ⏸ (Play/Pause) button to display the video associated with the selected event on the small search screen.

Figure 67 – Motion Search screen.

Highlighting **Close** and pressing the ⏸ button will extract the video associated with the Motion event and display the first image of the event. Pressing the ⏸ button will start playing the “event” video segment. Pressing **SEARCH** button returns to live monitoring.

You can also narrow your event search by selecting the **Option...** button and setting up the new search condition.

Motion Search Option	
From	<input checked="" type="checkbox"/> First 2010/06/07 14:20:44
To	<input checked="" type="checkbox"/> Last 2010/06/07 14:20:44
Type	Motion Search
Zone	720 Block(s)...
Sensitivity	3
Min. Blocks	1
<input type="button" value="Search"/> <input type="button" value="Cancel"/>	

You can search video from the first to last recorded images, or you can set the start and stop times and dates.

Highlight the box beside From and press the \odot button to toggle between On and Off. When set to Off, you can enter a specific Date and Time. When set to On, the search will be from the first recorded image.

Highlight the box beside To and press the \odot button to toggle between On and Off. When set to Off, you can enter a specific Date and Time. When set to On, the search will be from the last recorded image.

Highlight the box beside Type and press the \odot button. You can select between Motion Search and Museum Search. Motion Search detects motion in the defined area. Museum Search detects if a defined object has moved.

Highlight the box beside Zone and press the \odot button. An image from the video appears with a grid overlaid. You can turn sensor blocks On and Off to define the area of the picture in which you want to search for motion.

NOTE: Defining the area of the image in which you want to search for motion is nearly identical to setting up the DVR for Motion Detection. Please refer to *Motion Detection* screen in Chapter 3 — Configuration for more detailed instructions on setting up the detection blocks.

NOTE: When setting the Museum Search Zone, the zone should be placed inside of the border line of the target object. If the selected block is placed on the border line, the sensitivity of the Museum Search may decrease.

The zone should be placed or focused on the centre or, at least, within the outline of targeted object.

Highlight the box beside Sensitivity and press the \odot button. You will be able to select from 1 (low sensitivity) to 5 (high sensitivity).

Highlight the box beside Min. Blocks and press the \odot button. You will be able to set the number of sensor blocks that must be activated. Setting the Min Blocks will only be available if Motion Search is selected.

Once you set your desired search conditions, highlight Search and press the \odot button to display the search results in the Motion Search screen. Selecting Cancel exits the screen without saving the changes.

When you search for motion events of another camera, you will be asked whether or not you want to delete the previous search results from the list.

Text-In Search

Time		Transaction	
2009/06/04 09:16:22			Test.Inc // 16:42.3
2009/06/04 09:16:21	Garlic bread	\$ 1.15 1(s) \$ 1.15 // 16:42.3	
2009/06/04 09:16:21	Pan cake	\$ 3.15 1(s) \$ 3.15 // 16:42.3	
2009/06/04 09:16:21	Coke	\$ 2.20 1(s) \$ 2.20 // 16:42.3	
2009/06/04 09:16:20	Item	Unit price Qty amount // 16:42.3	
2009/06/04 09:16:20	abc Market	2009.01.01 AM 09:00 //	
2009/06/04 09:16:20	Garlic bread	\$ 1.15 1(s) \$ 1.15 // 16:42.3	
2009/06/04 09:16:20	Pan cake	\$ 3.15 1(s) \$ 3.15 // 16:42.3	
2009/06/04 09:16:19	Coke	\$ 2.20 1(s) \$ 2.20 // 16:42.3	
2009/06/04 09:16:19	Item	Unit price Qty amount // 16:42.3	

Option... Close

Figure 68 – Text-In Search screen.

NOTE: It is possible that no recorded image displays on the current screen. Change the screen mode to 3x3, for the 8-channel DVR and 2x2 for the 4-channel DVR, and you will be able to easily see the cameras that have recorded video during target time.

NOTE: Text Input information will be overlaid on the image while the recorded video is played at regular speed.

You can also narrow your event search by selecting the Option... button and setting up the new search condition.

Text-In Search Option						
From	<input checked="" type="checkbox"/> First	2010/06/07 14:00:20				
To	<input checked="" type="checkbox"/> Last	2010/06/07 14:00:20				
Channels	1-8					
Generic Text						
No.	-	Name	Comp.	Value	Column	Line
					0	0
					0	0
					0	0
					0	0
					0	0
					0	0
					0	0
+ <input type="checkbox"/> Case Sensitive						
Load		Save		Search		Cancel

Highlight the box beside TO and press the (⏮) button to toggle between On and Off. When set to Off, you can enter a specific Date and Time. When set to On, the search will be from the last recorded image.

Highlight the Channel and press the (⏮) button. Select the text-in devices that you want to search for text input.

Highlight the text input device box and press the (⏮) button. Select your Text Input Device from the list.



NOTE: The following description is for a *Generic Text* device. The screen changes for different types of text input devices, and there will be different parameter boxes for you to enter information.

The DVR maintains a log of each time there is Text Input. The Text-In Search screen displays this list. Use the arrow buttons to highlight the event for which you would like to see video.

Pressing the (⏮) (Play/Pause) button will extract the video associated with the Text Input and display the first image of the event. Pressing the (⏮) button will start playing the “event” video segment. Pressing [SEARCH] button returns to live monitoring.

You can search video from the first to last recorded images, or you can set the start and stop times and dates.

Highlight the box beside From and press the (⏮) button to toggle between On and Off. When set to Off, you can enter a specific Date and Time. When set to On, the search will be from the first recorded image.

Highlighting the + and pressing the  button allows you to add a new set of search parameter. Set up the desired search parameter. Refer to the *Appendix – Text-In Search Examples* for further information on setting up search parameters. The  column can be used to delete a set of search parameter or entire sets of search parameters.

Highlight **Case Sensitive** and press the  button. This will toggle between On and Off. When this feature is On, the search will find only those text strings in which the case matches.

Highlight **Load** and press the  button to load saved search option settings. Select the desired search option settings.

Highlight **Save** and press the  button to save the current search option settings. A virtual keyboard appears that you can use to enter the search option name.

Once you set your desired search conditions, highlight **Search** and press the  button to display the search results in the **Text-In Search** screen. Selecting **Cancel** exits the screen without saving the changes.

Clip-Copy

Video clips can be copied on an external USB hard disk or flash drive. The copied video clips can be viewed on computers running Microsoft Windows 98, ME, 2000, XP or Vista. Refer to the *Appendix – USB Hard Disk Drive Preparation* for information on preparing the external drive for clip copy.

Selecting **A-B Clip-Copy** from the **Export** menu in the **Search** menu or pressing the **BACK UP** button on the remote control during playback will set the starting point of the video to be clip copied, and the  icon displays at the bottom-left corner of the screen. Selecting **A-B Clip-Copy** again from the **Export** menu in the **Search** menu or pressing the **BACK UP** button again will set the ending point of the video to be clip copied by displaying the **Clip-Copy** screen.

Select **Clip-Copy** from the **Export** menu in the **Search** menu, press the **BACK UP** button on the remote control while in the **Live Monitoring** mode or press and hold the **BACK UP** button for more than three seconds while in the **Search** mode, and the **Clip-Copy** screen appears to allow clip copy setup.

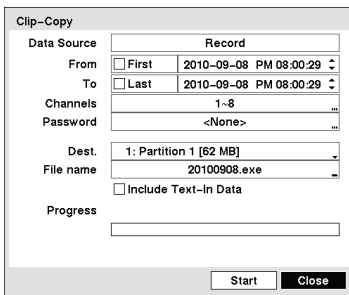





Figure 69 – Clip-Copy screen.

You can search video from the first to last recorded images, or you can set the start and stop times and dates.

Highlight the box beside **From** and press the  (Play/Pause) button to toggle between On and Off. When set to Off, you can enter a specific Date and Time. When set to On, the search will be from the first recorded image.

Highlight the box beside **To** and press the  button to toggle between On and Off. When set to Off, you can enter a specific Date and Time. When set to On, the search will be from the last recorded image.

Highlight the box beside **Channels** and press the  button. You can select the cameras that you would like to include in your video clip.

Highlight the box beside **Password** and press the  button. A virtual keyboard appears allowing you to enter the password for reviewing the video clips.

Highlight the box beside **Dest.** and press the  button. You can select the storage device on which you would like to record the video clip.

CAUTION: The USB device for clip copy must be FAT 16 or FAT32 format.

The DVR automatically assigns a file name to the video clip. However, you can give the video clip file a different name. Highlight the box beside **File Name** and press the  button. A virtual keyboard appears. Enter a file name for the video you are backing up and select **Close**. The DVR will automatically add the camera number (for example "01") and ".exe" to the file name.

NOTE: When naming a file, you cannot use the following characters: \, /, :, *, ?, ", <, >, |.

Highlight **Include Text-In Data** and press the  button. This will toggle between On and Off. When this feature is On, you can include text-in data when copying video if the video was recorded with text-in data.

Once you have given the video clip a file name, highlight the **Start** button and press the  button. The confirmation screen displaying data size will appear. When the storage device does not have enough space, the DVR will ask if you want to copy as much of the video clip as possible in the available space.

Highlight the **Continue** button and press the  button to continue clip copy.

Once the clip copy starts, you can cancel it by selecting **Cancel** or hide the screen by selecting **Close**. When selecting **Close**, Clip Copy continues and a confirmation screen will display when complete.

NOTE: The file size for clip copy is limited to 30GB. When copying video clips larger than 2GB, the video clips will be save in units of 2GB. For example, 3 individual 2GB files will be created when saving a 6GB video clip. However, the file size for the One-Touch Clip Copy is limited to 2GB.

You can use other functions on the DVR while video is being backed up. To do this, highlight the **Close** button and press the  button. You can return to the Clip-Copy screen at any time to check the progress.

You do not need to install any special software on your personal computer to review the video clips. Refer to the RAS manual for instructions on how to review video clips you have copied.

NOTE: During Clip Copy, you cannot shut the system down, clear data on the storage device, or format the storage device.

CAUTION: Do NOT disconnect the USB cable or the power from the external drive while copying video clips. If the external drive is shut down or the USB cable is disconnected while copying video clips, THE DVR SYSTEM MAY NOT WORK NORMALLY OR THE EXTERNAL DRIVE COULD BE DAMAGED, and you will get an error message the next time you try to copy video clips. You will need to power down the DVR and restart it to get rid of the error message. Once the file system of the USB hard disk drive has been corrupted, this error message cannot be dismissed. Even after restarting the DVR it may automatically restart while preparing to clip copy. You must recover the file system using the recovery program, or you must reformat the hard disk drive.

Appendix

USB Hard Disk Drive Preparation

Preparing the USB hard disk drive in Windows 2000

NOTE: Preparing a USB hard disk drive under Windows XP, Windows Vista and Windows 7 is almost identical to Windows 2000.

1. Connect the USB hard disk drive to your computer using the USB Cable.
2. Turn on your computer.
3. The USB device icon should display on the Taskbar.
4. If the USB hard disk drive is partitioned or has data, it will show up in *My Computer* as a hard disk drive icon. Check the file system by right clicking on the icon and checking under *Properties > General > File System*. If the file system is NOT FAT32 format, format the USB hard disk drive using the FAT32 format.
5. If the USB hard disk drive is not partitioned, go to *Administrative Tools in Control Panel* and launch *Computer Management*. Open *Disk Management in Storage* and right click an unallocated region of the USB hard disk drive. Then, click *Create Partition*.
6. In the *Create Partition wizard*, click *Next* then *Primary Partition*, and follow the instructions on the screen. Make sure that the FAT32 is selected for the file system.

NOTE: The partition size should be less than 32GB because of Microsoft limitations.

After formatting is complete, the USB hard disk drive will be added to *My Computer*.

7. Connect the USB hard disk drive to the DVR.

Preparing the USB hard disk drive in Windows 98

NOTE: Preparing a USB hard disk drive under Windows ME is almost identical to Windows 98.

1. Connect the USB hard disk drive to your computer using the USB Cable.
2. Turn on your computer. The *Add New Hardware wizard* window will appear.
3. Install the device driver for the USB backup device following the instructions provided with your USB hard disk drive.
4. If the USB hard disk drive is partitioned or contains data, it will show up in *My Computer* as a hard disk drive icon. Check the file system in *Properties > General > File System*. If the file system is NOT FAT32 format, format the USB hard disk drive with FAT32 format.
5. Run the FDISK utility by clicking *Start* then *RUN*. Type "fdisk" and click OK.
6. When the MS-DOS command prompt appears, type "Y" and hit the enter key.
7. In the FDISK Option menu, choose "5. Change current fixed disk drive."
8. Choose the appropriate letter corresponding to the USB hard disk drive.
9. In the FDISK Option menu, choose "1. Create DOS partition or Logical DOS Drive."
10. In the Create DOS Partition or Logical DOS Drive menu, choose "1. Create Primary DOS Partition." And Type "Y" to use all available space and hit the enter key. Hit ESC to exit the screen after the USB hard disk drive partition is created.
11. Restart your computer and verify the newly created drive is in *My Computer*.

12. Right click the newly created hard disk drive icon and select "Format".
13. In the Format Screen, select "Full" as the "Format type" and click "Start".
14. After formatting is complete, connect the USB hard disk drive to the DVR.

Text-In Search Examples

Search Example I

1
2
3
4
5
6

123456789012345678901234567890123456789012345678901234567890

Item	Unit price	Qty	amount
Coke	\$ 2.20	1 (s)	\$ 2.20
Fanta	\$ 2.20	1 (s)	\$ 2.20
Hotdog	\$ 3.50	3 (s)	\$ 10.50
Pepsi	\$ 1.95	1 (s)	\$ 1.95
total : \$			16.85

Thank you~~

In the above text-in data, you can find that the comparison value is located at 17th (Unit price, \$ mark will be ignored automatically), 28th (Qty) and 40th (amount) characters (including spaces) from the left. In this case, you can enter "17", "28" and "40" in each Column box.

For example, if you want to search for Coke with a Qty (Quantity) of more than 1 and Hotdog with an amount totaling over \$8, the following search condition can be set.

Text-In Search Option

From First 2010/06/07 14:01:27

To Last 2010/06/07 14:01:27

Channels 1~8

Generic Text

No.	Name	Comp.	Value	Column	Line
1	Coke	>	1	28	0
2	AND Hotdog	>	8	40	0
				0	0
				0	0
				0	0

Case Sensitive

Search Example II

1 2 3 4 5 6
 123456789012345678901234567890123456789012345678901234567890

Item	Unit price	Qty	amount
Coke	\$ 2.20	1 (s)	\$ 2.20
Fanta	\$ 2.20	1 (s)	\$ 2.20
Hotdog	\$ 3.50	3 (s)	\$ 10.50
Pepsi	\$ 1.95	1 (s)	\$ 1.95
total : \$			16.85

Thank you~~

In the above text-in data, you can find that the comparison value is located at 17th (Unit price, \$ mark will be ignored automatically), 28th (Qty) and 40th (amount) characters (including spaces) from the left, but the value of amount category is located on a different line from Item. In this case, you can enter “17”, “28” and “40” in each Column box and enter “1” in the Line box for the next line.

For example, if you want to search for Coke with a Qty (Quantity) of more than 1 and Hotdog with an amount totaling over \$8, the following search condition can be set.

Text-In Search Option

From First 2010/06/07 14:01:27

To Last 2010/06/07 14:01:27

Channels 1~8

Generic Text

No.	Name	Comp.	Value	Column	Line
1	Coke	>	1	28	0
2	AND Hotdog	>	8	40	1
				0	0
				0	0
				0	0

Case Sensitive

Load Save Search Cancel

WebGuard

WebGuard allows you to access a remote DVR, monitor live video images and search recorded video using Internet Explorer web browser anytime from virtually anywhere.

Computer system requirements for using the WebGuard program are:

- Operating System: Microsoft® Windows® 2000, Microsoft® Windows® XP, Microsoft® Windows® Vista or Microsoft® Windows® 7
- CPU: Intel Pentium III (Celeron) 600MHz or faster
- RAM: 128MB or higher
- VGA: 8MB or higher (1024x768, 24bpp or higher)
- Internet Explorer: Version 6.0 or later

Start Internet Explorer on your local PC. You can run the WebGuard program by entering the following information in the address field.

- “http://IP address:port number” (The DVR IP address and the WebGuard port number (default: 12088) set in the Network setup screen (WebGuard tab))
- Or, “http://DVRNS server address/DVR name” (The DVRNS server address and the DVR name registered on the DVRNS server)
- Or, “http://www.dvronline.net” (Entering the DVR IP address or the DVR name will be required when logging in)

NOTE: You will need to get the appropriate IP address for the DVR you want to connect to and the WebGuard port number from your network administrator.

NOTE: WebGuard only works with Microsoft Internet Explorer and will NOT work with other browsers.

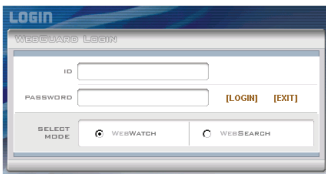

Select between the WEBWATCH (Web monitoring) and WEBSEARCH (Web search) modes. Entering ID and PASSWORD and clicking the [LOGIN] button logs in using the selected mode.

You will need to enter the DVR IP address in the DVR ADDRESS field when running the WebGuard program by entering <http://www.dvronline.net>. Selecting the Use DVRNS option allows you to enter the DVR name registered on the DVRNS server instead of the IP address. You must enter the DVRNS server address and port number in the SETUP setting when selecting the Use DVRNS option.

NOTE: Do NOT close the LOGIN window during the WebGuard operation, otherwise, it will cause a script error when switching between Web monitoring and Web search modes and running the WebGuard program again will be required.

NOTE: When running the updated WebGuard for the first time, Internet Explorer might occasionally load the information of the previous version. In this case, delete the temporary internet files by selecting Tools → Internet Options → General tab, and then run WebGuard again.

NOTE: There might be a problem that the bottom of WebGuard page is cropped due to the address or status bars in Microsoft Internet Explorer 7.0. In this situation, it is recommended that websites open windows without address or status bars by changing the internet setting. (Go to the Tools → Internet Options → Security tab → Click the Custom level... button → Select *Enable* for the *Allow websites to open windows without address or status bars* option)

NOTE: When running WebGuard in the Microsoft Windows Vista or higher operating system, it is recommended to start Internet Explorer with elevated administrator permissions. Click the right mouse button on the Internet Explorer icon and select the *Run as administrator* option from the context menu. Otherwise, some functions of WebGuard might be limited.

NOTE: There might be a problem with screen display or screen update due to low image transmission speed when using the Microsoft Windows Vista or higher operating system. In this situation, it is recommended you disable the Auto Tuning capability of your computer.

Run the Command Prompt with elevated administrator permissions (Go to the Start Menu → Accessories → *Command Prompt* → Click the right mouse button and select the *Run as administrator* option). Then enter “netsh int tcp set global autotuninglevel=disable” and hit the enter key. Restart your computer to apply the changes.



If you want to enable the Auto Tuning capability again, enter “netsh int tcp set global autotuninglevel=normal” after running the Command Prompt with elevated administrator permissions. Restart your computer to apply the changes.

Web Monitoring Mode

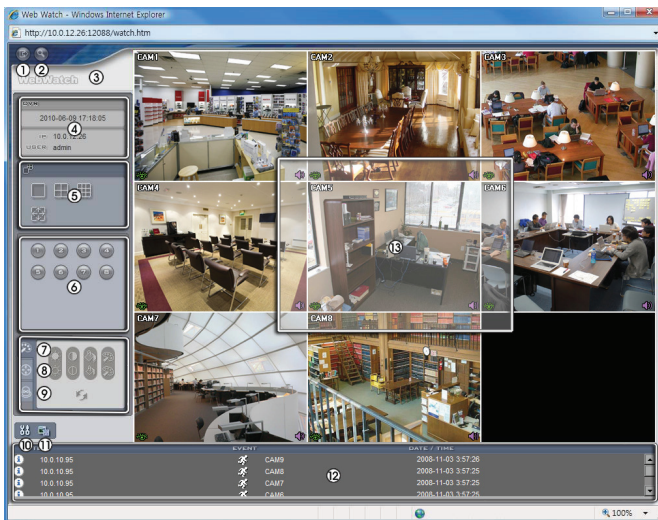

WebWatch is a remote web monitoring program that allows you to monitor live video transmitted in real-time from the remote DVR.





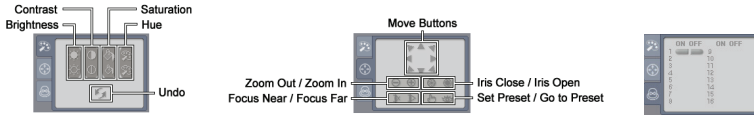

- ① Click the [X] to log out the WebGuard program.
- ② Click the [S] to access to the web search mode.
- ③ Position the mouse pointer on the WebWatch logo to see the version of the WebGuard program.
- ④ The DVR information window displays the login information of WebGuard.
- ⑤ Click the screen format to select the desired display mode. When changing the screen format, the selected camera on the current screen will be located in the first cell of the new layout.

- ⑥ Click the camera button to select the camera to be viewed.
- ⑦ Click the  to adjust the brightness, contrast, saturation and hue of monitoring image.
- ⑧ Click the  to control pan, tilt and zoom of the camera from a remote site.
- ⑨ Click the  to control alarm out devices at the remote site.



- ⑩ Click the  to set up the image drawing mode and OSD display. You can adjust the display speed by changing the image drawing mode, and select OSD information to be displayed on the screen.
- ⑪ Click the  to save the current image as a bitmap or JPEG file format.
- ⑫ The event status window at the bottom displays a list of events that were detected from the remote site.
- ⑬ Selecting a camera on the screen and clicking the right menu button displays the text menu screen.

Change Camera Title	
Enable Audio	
Aspect Ratio	▶
Deinterlacing	▶
Anti-Aliasing Screen	

- Change Camera Title: Changes the camera name.
- Enable Audio: Enables audio communication with the remote site. When the audio control panel displays, click the  to send audio to the connected remote site and click the button again to stop sending audio. Click the  to monitor live audio from the connected remote site through the attached speaker and click the button again stop monitoring live audio. Clicking both  and  allows two-way communication. Clicking the  disables audio communication.

- Aspect Ratio: Changes the image aspect ratio.
- Deinterlacing: Using a deinterlace filter for interlaced video enhances image display quality by eliminating horizontal scan lines and noise in areas with motion.
- Anti-Aliasing Screen: Enhances image display quality by eliminating stair stepping (aliasing) effects in the enlarged image.

NOTE: A camera name change in the Web Watch mode does not affect the camera name set up on the remote site. Leaving the Camera Title blank causes the camera name set up on the remote site to display.

NOTE: The  icon will display on each camera screen when audio communication is available between the WebGuard system and a DVR.

Web Search Mode

WebSearch is a remote web search program that allows you to search recorded video on the remote DVR.

NOTE: The remote site connection in the Web Search mode will automatically be disconnected if there is no activity for 30 minutes.







- ① Click the to log out the WebGuard program.
- ② Click the to access to the web monitoring mode.
- ③ Position the mouse pointer on the WebSearch logo to see the version of the WebGuard program.
- ④ The DVR information window displays the time information of recorded data on the remote DVR and login information of WebGuard.
- ⑤ Click the to blur, sharpen, equalize and interpolate playback images. Click the to zoom out or zoom in the recorded image. Click the to adjust the brightness of the recorded images.

NOTE: Image processing works only in the pause mode.

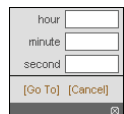

- ⑥ The playback function buttons include fast backward, pause, play, fast forward, go to the first image, go to the previous image, go to the next image, and got to the last image.
- ⑦ Click the screen format to select the desired display mode.
- ⑧ Click the to enter the time-lapse search mode which allows you to search for recorded data by time and then play back images found within the time parameters. The Timetable window located at the bottom displays the time information for the image of the date selected on the calendar. If more than one video stream in the same time range, you can select the video stream you want to search. Clicking a specific time displays the image recorded at that time on the screen. Selecting the allows you to display an image from a specific time.
- ⑨ Click the to enter the event search mode which allows you to search for event log entries using specific conditions and play back the images associated with those event entries.
- ⑩ Click the to set up the image drawing mode and OSD display. You can change the display speed by adjusting the image drawing mode, and select OSD information to display on the screen.



- ⑪ Click the  to save any video clip of recorded data as an executable file, or click the  to save the current image in a bitmap or JPEG file format.
- ⑫ Click the  to print the current image on a printer connected to your computer.
- ⑬ Click the  to reload the recording data.
- ⑭ The timetable displays recorded data of the selected camera by time (in hour segments).
- ⑮ Selecting a camera on the screen and clicking the right mouse button displays the text menu screen.

Change Camera Title	
Enable Audio	
Aspect Ratio	▶
Deinterlacing	▶
Anti-Aliasing Screen	

- **Change Camera Title:** Changes the camera name.
- **Enable Audio:** Plays audio while playing back recorded video that has recorded audio. (Single-Screen Layout Only)
- **Aspect Ratio:** Changes the image aspect ratio.
- **Deinterlacing:** Using a deinterlace filter for interlaced video enhances image display quality by eliminating horizontal scan lines and noise in areas with motion.
- **Anti-Aliasing Screen:** Enhances image display quality by eliminating stair stepping (aliasing) effects in the enlarged image.

NOTE: A camera name change in the Web Search mode does not affect the camera name set up on the remote site. Leaving the Camera Title blank causes the camera name set up on the remote site to display.





System Log Notices

Boot Up	Setup Begin	Panic Off
Shutdown	Setup End	Clear All Data
Restart	Remote Setup Change	Format Disk
Upgrade	Remote Setup Fail	Disk Full
Upgrade Fail	Setup Imported	Auto Deletion
Time Change	Setup Import Failure	Search Begin
Time Zone Change	Setup Exported	Search End
Time Sync	Setup Export Failure	Clip-Copy Begin
Time Sync Fail	Setup Export Cancel	Clip-Copy End
Disk Bad	Schedule On	Clip-Copy Cancel
Login	Schedule Off	Clip-Copy Fail
Logout	Panic On	Callback Fail

Error Code Notices

System Upgrade Related		Clip Copy Related	
No.	Description	No.	Description
0	Unknown error.	0	Unknown error.
1	File version error.	1	Device error.
2	Operating system version error.	2	Mounting failed.
3	Software version error.	3	No media.
4	Kernel version error.	4	Invalid media.
100	Upgrade device mounting failed.	5	File already existed.
101	Package is not found.	6	Not enough space.
102	Extracting package failed.	7	Creating temporary file failed.
103	LILLO failed.	8	Opening disk failed.
104	Rebooting failed.	9	Formatting disk failed.
105	Invalid package.	10	Database has been changed.
300	Remote connection failed.	11	Appending failed.
301	Remote network error.	12	Bad sector.
302	Remote upgrade is not authorized.	13	No executable file.
303	Saving remote package failed.	14	Opening executable file failed.
304	Remote upgrade is cancelled by the user.	15	Writing executable file failed.
400	USB device mounting failed.	16	Creating image failed.
401	Reading upgrade package on the USB device failed.		
402	Copying upgrade package on the USB device failed.		
500	System is busy clip copying.		

Troubleshooting

Problem	Possible Solution
No Power	<ul style="list-style-type: none"> • Check power cord connections. • Confirm that there is power at the outlet.
No Live Video	<ul style="list-style-type: none"> • Check camera video cable and connections. • Check monitor video cable and connections. • Confirm that the camera has power. • Check camera lens settings.
DVR has stopped recording	If hard disk drive is full, you will either need to delete video or set the DVR to the Overwrite Mode.
The icon  displays, however, the DVR is not recording.	When the DVR is in the Pre-Event recording mode, the yellow  and  display when there is no event, and the DVR is not recording. The red  and  display when any event occurs and the DVR starts recording.

Map of Screens

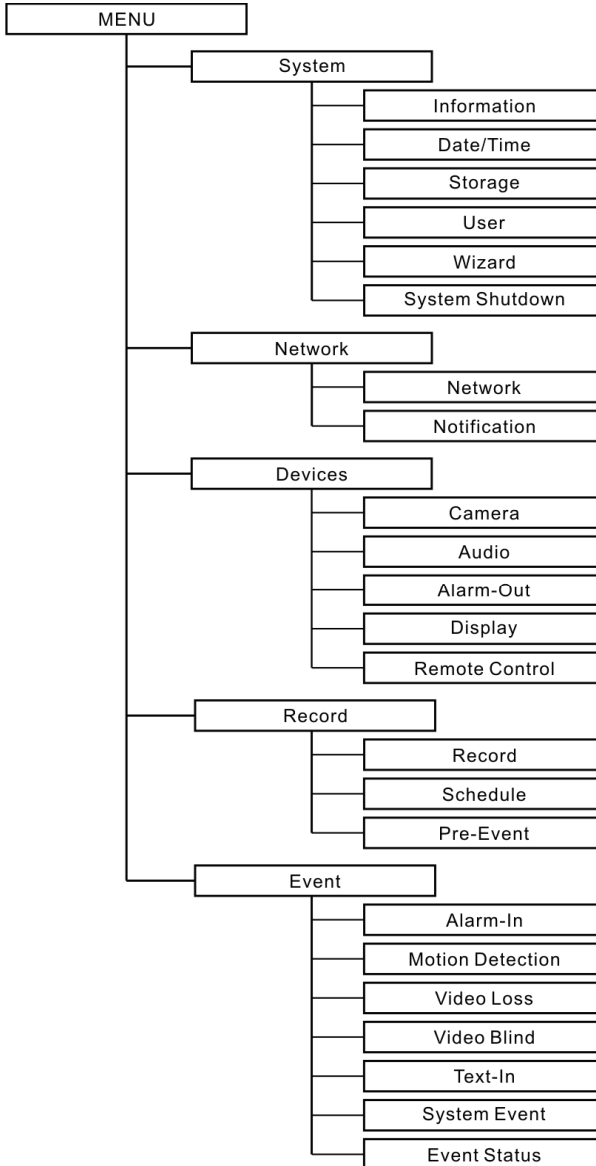





Specifications

VIDEO	
Signal Format	NTSC or PAL (Auto Detect)
Video Input	Composite: 4 or 8 inputs, 1 Vp-p, auto-terminating, 75 Ohms
Monitor Outputs	Composite: 1 BNC, 1 Vp-p, 75 Ohms VGA: 1 (Auto Detect)
Video Resolution	Composite: 720x480 (NTSC), 720x576 (PAL) VGA: 800x600, 1024x768, 1280x1024@60Hz
Playback/Record Speed (images per second)	8-ch Model: 240ips (NTSC), 200ips (PAL) @ CIF (Full Duplex) 4-ch Model: 120ips (NTSC), 100ips (PAL) @ CIF (Full Duplex)

INPUTS/OUTPUTS	
Alarm Input	4 or 8 TTL, programmable as NC or NO, 4.3V threshold
Alarm Output	1 relay output, terminal blocks, 1A@30VDC
Internal Buzzer	80dB at 10cm
Network Connectivity	10/100 Mbps Ethernet (RJ-45)
Audio Input	RCA Input: 4 (independent), Line In
Audio Output	RCA Output: 1, Line Out
Text Input	POS Interface, ATM Interface

CONNECTORS	
Video Input	Composite: 4 or 8 BNC
Monitor Output	Composite: 1 BNC VGA: 1 VGA
Audio In	4 RCA connector
Audio Out	1 RCA connector
Alarm Input/Output	Terminal blocks
Ethernet Port	RJ-45
RS232 Serial Port	Two-connector terminal block
RS485 Serial Port	Two-connector terminal block
USB Port	2 (USB 2.0)
IR Port	1 Remote Control

STORAGE	
Primary Storage	SATA hard disk drive
Secondary Storage	USB hard disk drive or flash drive

GENERAL	
Dimensions (W x H x D)	10.4" x 2.0" x 11.3" (265mm x 52mm x 288mm)
Unit Weight	3.7 lbs. (1.7kg)
Shipping Weight	7.3 lbs. (3.3kg)
Shipping Dimensions (W x H x D)	14.2" x 4.3" x 18.1" (360mm x 110mm x 460mm)
Operating Temperature	41°F to 104°F (5°C to 40°C)
Operating Humidity	0% to 90%
Power	8-ch Model: 12V  , 1.2A (Adaptor: 100-240 V~, 50/60Hz, 1.5A, 12V  , 5A) 4-ch Model: 12V  , 1.2A (Adaptor: 100-240 V~, 50/60Hz, 1.0A, 12V  , 3A)
Power Consumption	Max. 25W
Approvals	FCC, CE

Specifications are subject to change without notice.