

USER'S MANUAL

METER HOOD 60

Thank you for purchasing PIVOT METER HOOD 60 "Multi-Purpose Type" MH6-U. Please read these instructions carefully before installing or using this device. Please do not lose this user's guide, as you will held liable for the cost of reissuing it.

Check the contents



! If the hood gets dirty please wipe with a soft cloth to remove any dirt. Do not use chemical cleansers such as thinner, benzene, or alcohol.

With just some double-sided tape, anyone can mount to a flat surface such as a dashboard.

※ Simple processing is possible to match the mounting surface of choice, but for curved surfaces use our "Processing Kit".

1 Decide the Place of Installation

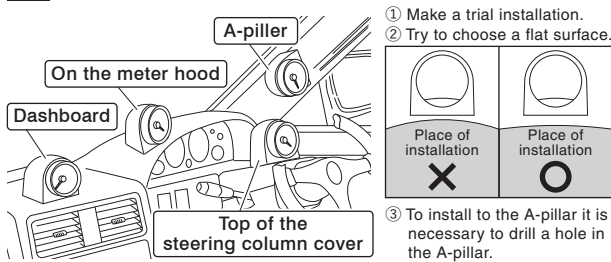

! When deciding a place for installation make sure to select a place that does not interfere with airbags, standard measurement gauges, nor gets in the line of vision.

Actual size of mounting side of hood

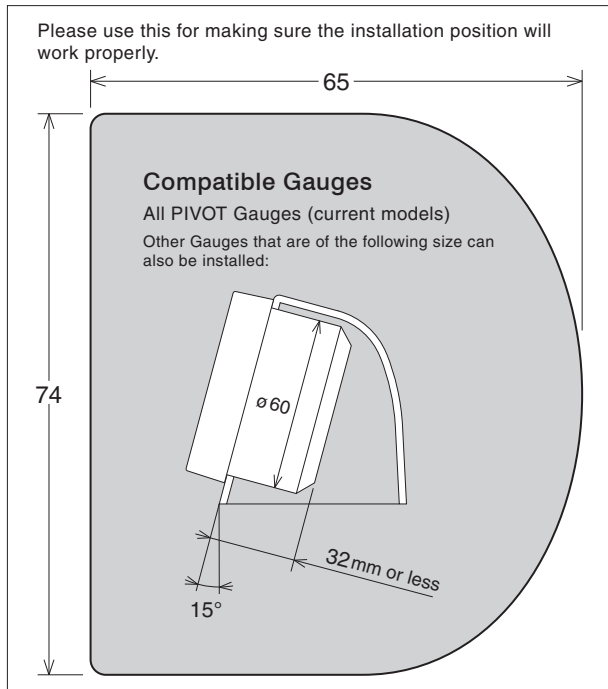

2 Fastening the Hood

Installing with the Double-sided tapes (dashboard, etc.)

- With screws fasten the stays to the holes.
- With a mild detergent or alcohol remove all dirt and oil from the point of installation, lay the wires down in the wire channels and fasten down with the double-sided tape.

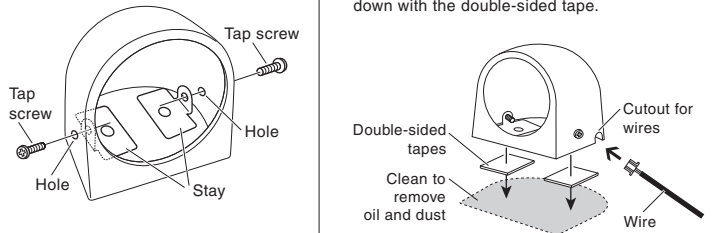

Installing to the A-pillar

※ For details about how to remove the A-pillar, see the maintenance guide for your model of car.

- Temporarily fasten the stays to the hood and for now fasten to the location with double-sided tape.
- With a marking pen make a mark for a wiring hole.

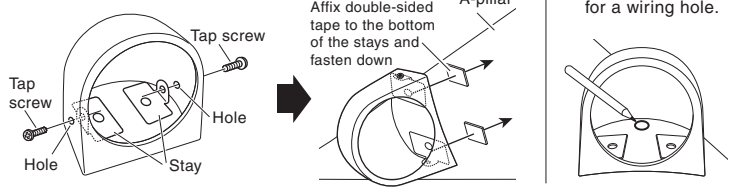

- Remove the hood and tap screws.
- With the stays still fastened remove the A-pillar.
- Open holes for the stays and for the wiring (wire size) that were made in ②.

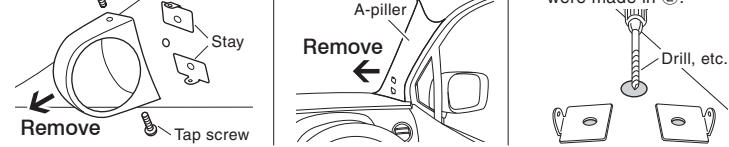

- Using the holes made in ⑤ fasten hood to the stays with the screws.
- Screw the hood back onto the stays.
- As you are leading the wires replace the A-pillar.

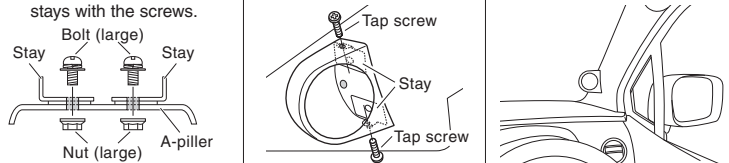

3 Fasten the meter to the meter hood

Fasten the supplied cushion tape to the meter case and fix the meter hood.

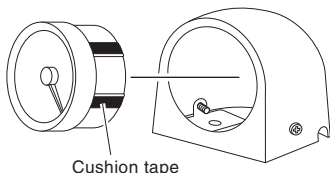

! The tap screws will make ridges as they are being screwed in, but if closed too tightly they may not hold; if this happens please use the nuts and washers provided in the kit to securely fasten.

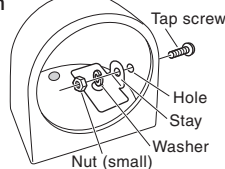

! When cutting away at the bottom of the hood to match the shape of the installation surface please take note of the following.

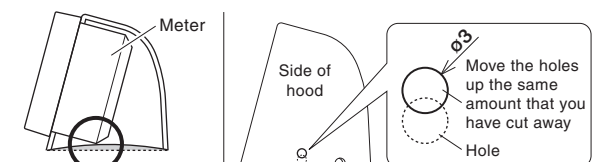

Make sure not to cut away too much so that the bottom of the gauge hits the installation point. If you have cut away the side of the hood, make sure to reopen the screw holes for the stays.