

### STM32-based LCD controller for TFT-LCDs

#### Introduction

This user manual describes the hardware details for the STEVAL-CCM002V1 demonstration board "STM32-based LCD controller for TFT-LCDs" and the STM32-based demonstration firmware. The system demonstrates the capabilities of the high-performance flexible static memory interface (FSMC) of the STM32 for driving a TFT-LCD. The 3.5" QVGA resolution TFT-LCD panel is interfaced with STM32 FSMC peripheral. The board is designed to be interfaced as a daughterboard for the STM3210E-EVAL demonstration kit.

To summarize, the key features of the system are:

- Displays images on the TFT-LCD using the STM32 as the LCD controller
  - Banner display of images to show animation
  - Slideshow of images to demonstrate static display model
- STM32 FSMC drives the TFT using external SRAM as refresh RAM
- Double-buffer allocation in refresh SRAM allows updating the source of dynamic images
- On-board constant current drive circuit for the LEDs of the TFT-LCD backlight
- Dimming control for the LEDs of the TFT-LCD backlight
- Jumper headers offering freedom for easy analysis of the TFT-LCD interface to the microcontroller

**Figure 1. STM32-based LCD controller for TFT-LCD**

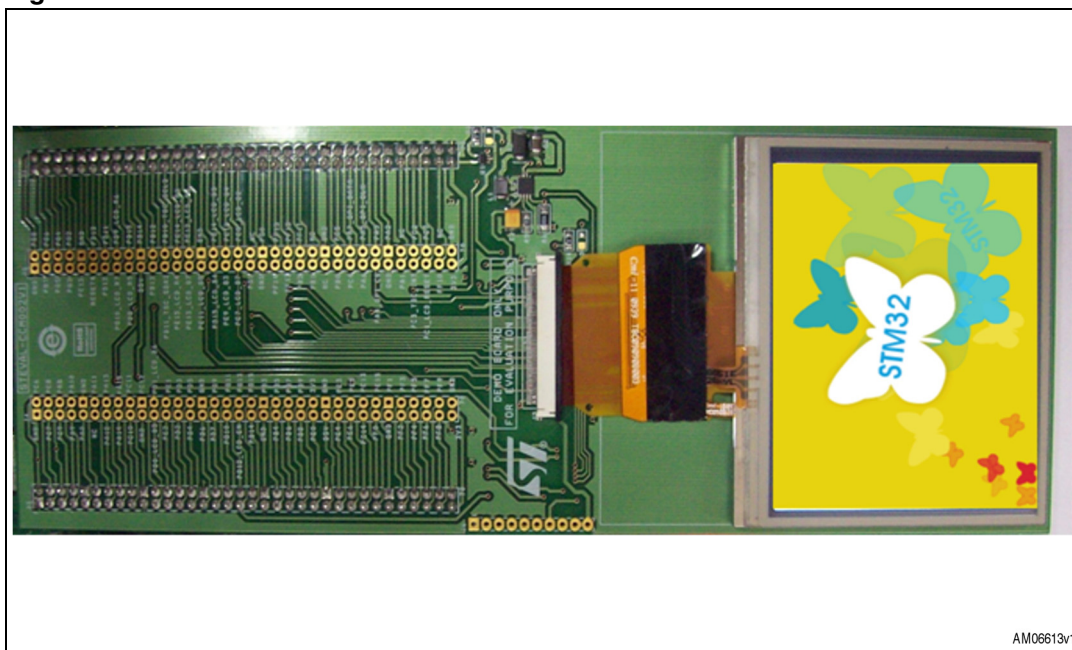

# Contents

<b>1</b>	<b>Getting started</b> .....	<b>4</b>
1.1	Package .....	4
1.2	Hardware installation .....	4
1.3	Hardware setup for MB672 Rev. B .....	5
1.4	Demonstration images .....	5
1.5	Software installation .....	5
<b>2</b>	<b>Hardware layout</b> .....	<b>6</b>
<b>3</b>	<b>Hardware details</b> .....	<b>8</b>
3.1	Connectors J1 ,J3 .....	8
3.2	Jumper headers J2,J4 .....	8
3.3	Connector J5 .....	8
3.4	Jumper header J6 .....	8
3.5	Single-channel Schmitt inverter U1 .....	8
3.6	LED backlight controller U2 .....	8
3.7	Touchscreen controller U3 .....	9
3.8	Low-drop power Schottky rectifier D1 .....	9
3.9	TFT-LCD .....	9
<b>4</b>	<b>Running the demonstration</b> .....	<b>10</b>
4.1	STM32 banner display .....	10
4.2	STM32 slideshow display .....	10
4.3	TFT-LCD backlight dimming control .....	10
<b>5</b>	<b>Troubleshooting</b> .....	<b>11</b>
<b>6</b>	<b>Revision history</b> .....	<b>18</b>

## List of figures

Figure 1.	STM32-based LCD controller for TFT-LCD	1
Figure 2.	STEVAL-CCM002V1 demonstration board mounted on MB672 STM3210E-EVAL demonstration board	4
Figure 3.	Hardware layout: top view	6
Figure 4.	Hardware layout: bottom view	7
Figure 5.	STM32 display mode switching	10
Figure 6.	STM32 demonstration board connector section for TFT-LCD	12
Figure 7.	TFT-LCD 54-pin connector	13
Figure 8.	Single-channel inverter and LCD backlight driver	14
Figure 9.	Touchscreen controller	15

# 1 Getting started

## 1.1 Package

The demonstration kit package includes the following items:

- Hardware content
  - STEVAL-CCM002V1 demonstration board
- Software content
  - STEVAL\_CCM002V1.hex file
- Documentation
  - User manual (this document)
  - Application note AN3241 from [www.st.com](http://www.st.com)
  - Presentation
  - Schematics
  - BOM

## 1.2 Hardware installation

The STEVAL-CCM002V1 demonstration board is the daughterboard for the MB672 STM3210E-EVAL demonstration board.

For the board demonstration setup, follow the steps below:

1. Connect STEVAL-CCM002V1 board connectors J3 and J1 to CN10 and CN11 respectively of the MB672 STM3210E-EVAL demonstration board
2. Power on the MB672 STM3210E-EVAL demonstration board

**Figure 2. STEVAL-CCM002V1 demonstration board mounted on MB672 STM3210E-EVAL demonstration board**

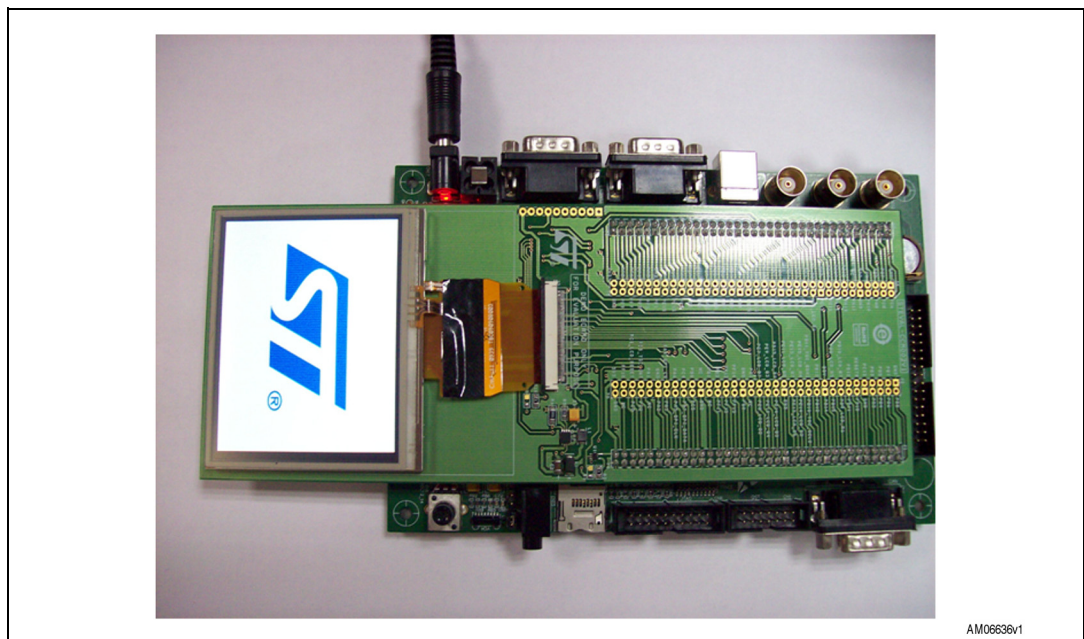

## 1.3 Hardware setup for MB672 Rev. B

Rev. B of the MB672 STM3210E-EVAL demonstration board is the release of an older version. Rev. B differs from rev. D in terms of the placement of three signals: PD14, PD15 and PE1 on connectors CN10 and CN11 of the STM32E-Eval kit. Hence, certain changes are required in the hardware to run the demonstration on the rev. B kit. The demonstration firmware can be run on rev. B, mapping signals to the appropriate pin numbers as follows:

- Signal connection changes on the STM32-E EVAL MB672 rev. B kit:
  - Connect pin 9 and pin 11 of CN11 to pin 31 and 32 of CN11, respectively
  - Connect pin 48 of CN10 to pin 24 of CN10
- Signal connection changes on the STEVAL-CCM002V1 demonstration board:
  - Pin PE1 on CN10 connects to 3.3 V when STEVAL-CCM002V1 is mounted on STM32-E EVAL rev. B. Disconnect the track of pin 48 of J3 from 3.3 V
- After successfully mapping the signals, follow the steps below to run the demonstration:
  - Connect STEVAL-CCM002V1 board connectors J1 and J3 to CN10 and CN11 respectively of the MB672 STM3210E-EVAL demonstration board
  - Power on the MB672 STM3210E-EVAL demonstration board

## 1.4 Demonstration images

The demonstration makes use of static images present in NOR memory of the MB672 STM3210E- EVAL demonstration board. The images are copied by the firmware from NOR memory to on-board external SRAM during firmware initialization. Then, the image files are refreshed on the TFT-LCD by the microcontroller from the external SRAM only.

These images are programmed by default in NOR memory of the MB672 STM3210E- EVAL demonstration board. If the images are not available in NOR memory, they can be easily programmed in NOR memory using the USB DFU firmware.

The STM3210E-EVAL\_NORFlash.dfu file for images is available in the firmware package with AN3241 on [www.st.com](http://www.st.com).

For more details about the board and NOR programming, refer to user manual UM0549 on [www.st.com](http://www.st.com). The USB DFU firmware is available for download from the STMicroelectronics website: [www.st.com](http://www.st.com).

## 1.5 Software installation

For firmware package installation and operation, refer to the firmware associated with AN3241 on [www.st.com](http://www.st.com).

## 2 Hardware layout

The demonstration kit hardware is designed with on-board jumper headers to offer easy signal analysis for TFT-LCD interfacing to the STM32.

Figure 3. Hardware layout: top view

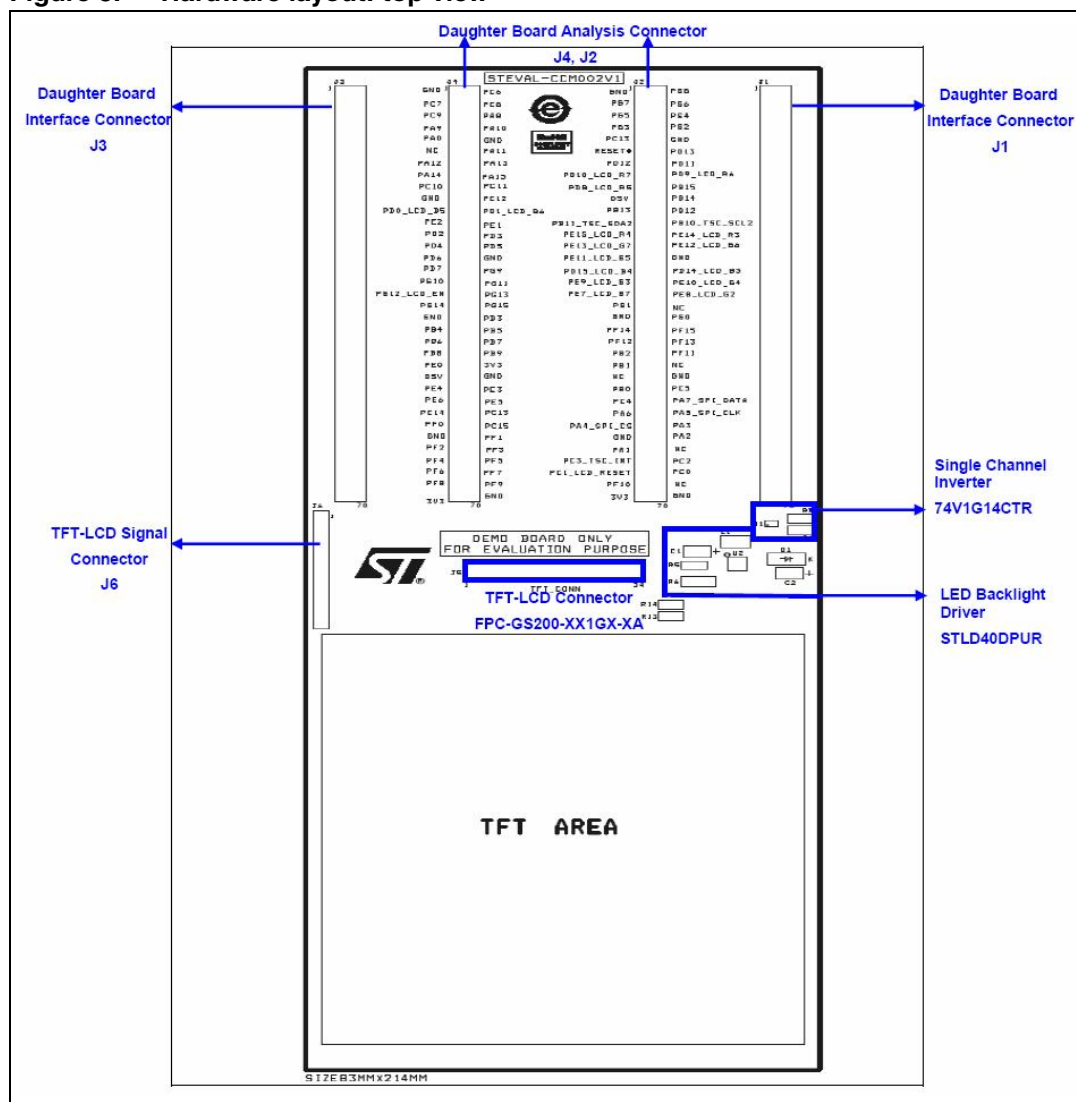
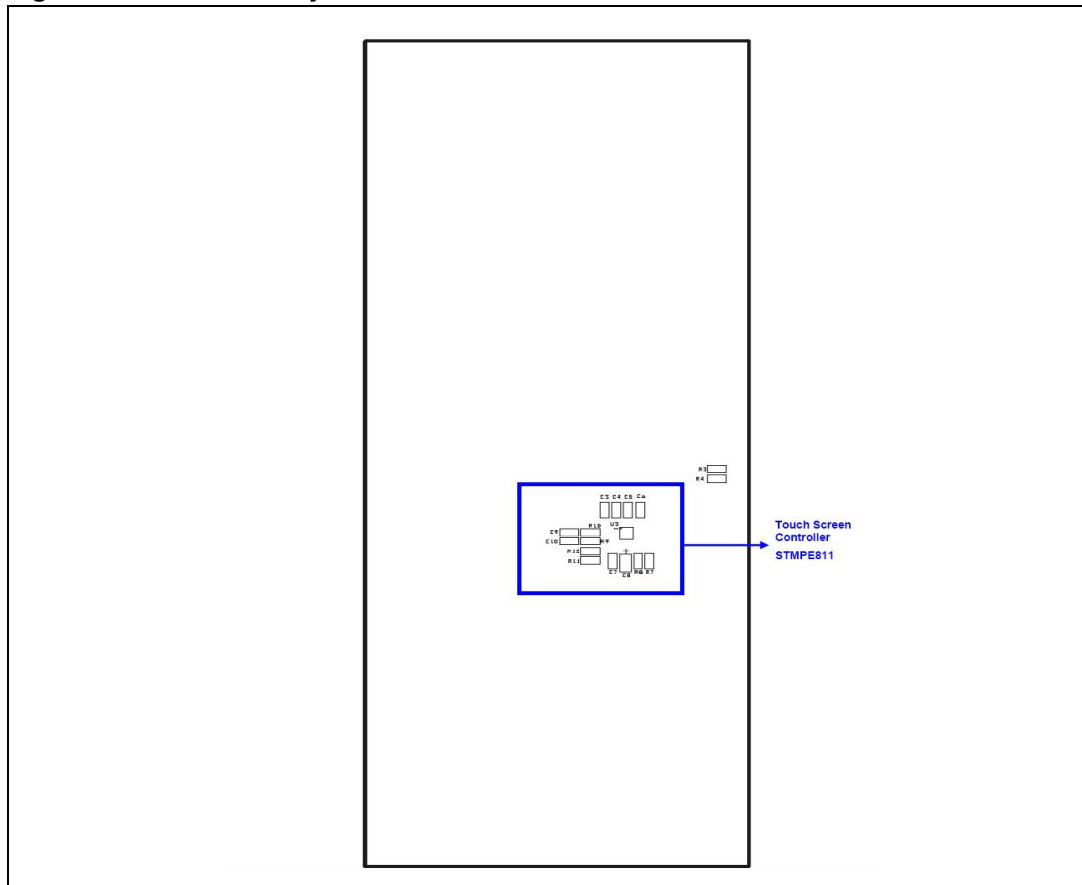

Figure 4. Hardware layout: bottom view



## 3 Hardware details

### 3.1 Connectors J1 ,J3

J1, J3 (70PS, 2.54 mm dual-row female sockets) are mounted on the board to interface the STEVAL-CCM002V1 demonstration board as a daughterboard to the MB672 STM3210E-EVAL demonstration board.

### 3.2 Jumper headers J2,J4

J2, J4 (70PS, 2.54 mm dual-row male headers) can be mounted on the board and are offered to allow easy analysis of TFT-LCD interfacing signals.

### 3.3 Connector J5

J5 FPC-GS200-XX1GX-XA (54PS, FPC connector 0.5 mm ZIF, side-entry SMT) is mounted to connect the TFT-LCD glass to the STEVAL-CCM002V1 demonstration board.

### 3.4 Jumper header J6

J6 (10PS, 2.54 mm single-row male header) is the signal analysis connector for the major TFT-LCD signals - touch signals, synchronization signals, backlight signals.

If the TFT-LCD signals are to be connected from sources other than the STM32 FSMC signals, then R3, R4 can be demounted and J6 can be mounted to analyze the TFT-LCD signals.

### 3.5 Single-channel Schmitt inverter U1

U1 74V1G14CTR (SOT223-5L) is a single Schmitt inverter.

U1 is mounted on-board to invert the microcontroller FSMC write-enable output signal. The inverted FSMC write-enable signal acts as a pixel clock for the TFT-LCD panel.

### 3.6 LED backlight controller U2

U2 STLD40DPUR (QFN8) is the white LED power supply for the large display backlight. It is capable of driving up to 10 white LEDs in series with maximum output of 20 mA and 37 V.

U2 is mounted to drive 6 white LED backlights of the on-board TFT-LCD with output current of 20 mA and voltage 19.2 V.

PB6 of STM32F103ZET6 is interfaced to enable the input of U2. A 1 KHz PWM signal output on PB6 from STM3210E is used as the enable input for U2. The TFT-LCD backlight dimming control is implemented on the board by varying the duty cycle of the enable PWM signal.

On-board potentiometer RV1 on the MB672 STM3210E-EVAL demonstration board is used to demonstrate dimming control. Potentiometer RV1 is interfaced to MCU STM3210E of the



MB672 STM3210E-EVAL demonstration board using an ADC channel. Rotate the potentiometer RV1 for TFT-LCD dimming control.

For more details about potentiometer hardware interface, refer to the user manual offered with the MB672 STM3210E-EVAL demonstration board.

*Note:* *STLD40DPUR is offered with the IC surface acting as PGND (power ground). Make sure to connect PGND to the ground terminal of the board.*

### 3.7 Touchscreen controller U3

U3 STMPE811QTR (QFN16) is a 4-wire resistive touchscreen controller with a 12-bit ADC for accurate, single-point touch detection. It converts touch on the touchscreen to digital touch coordinates.

U3 is interfaced with four touch-sensing lines (TSC\_X1, TSC\_X2, TSC\_Y1, and TSC\_Y2) of the TFT-LCD. The STMPE811 supports SPI and I<sup>2</sup>C interfacing. Here, the STMPE811 is interfaced to the microcontroller of the MB672 STM3210E-EVAL demonstration board using I2C2 interface.

U3 is not mounted on-board in the present solution .It can be easily mounted to support touch detection.

### 3.8 Low-drop power Schottky rectifier D1

D1 STPS1L30A (SMA, VRRM = 30 V, IF = 1 A, VF = 0.3 V) is used for reverse-recovery control in the U2 backlight control circuit.

### 3.9 TFT-LCD

TFT-LCD CT05350DW0000T is a transmissive TFT (thin film transistor) active matrix color liquid crystal display (LCD) comprising an amorphous silicon TFT attached to each signal electrode. The model consists of a TFT-LCD module, a driver circuit, backlight unit and 4-wire touch panel.

The resolution of the 3.5" TFT-LCD contains 320 × 240 pixels and can display up to 16.7 M colors.

## 4 Running the demonstration

The STEVAL-CCM002V1 demonstration board is the interface board for the TFT-LCD. The microcontroller for driving the TFT-LCD is available on the MB672 STM3210E-EVAL demonstration board. Hence, the STEVAL-CCM002V1 demonstration board is mounted as the daughterboard to the MB672 STM3210E-EVAL demonstration board. The board supports two modes of display:

- STM32 banner display
- STM32 slide-show display

### 4.1 STM32 banner display

Upon successful power-up of the board, animation starts to play. In this mode, multiple images display one after the other, enlivening the presentation.

Press key B3 to switch to slideshow mode.

### 4.2 STM32 slideshow display

Upon successful power-up of the board, two static images are displayed on the TFT-LCD as in a slideshow.

Figure 5. STM32 display mode switching

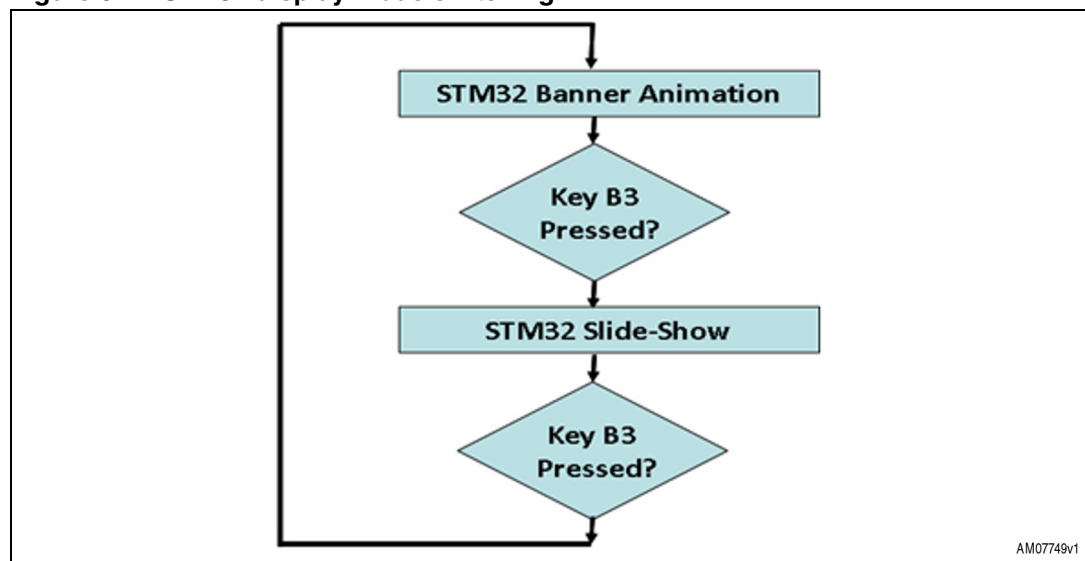

### 4.3 TFT-LCD backlight dimming control

The MB672 STM3210E-EVAL demonstration board potentiometer RV1 can be used to control the dimming of the TFT-LCD backlight.

## 5 Troubleshooting

### TFT-LCD display is black upon power-on

- Reason: STM32-E demonstration kit on-board potentiometer RV1 is on zero
- Solution: rotate the potentiometer RV1 to see the display

### TFT-LCD display is white upon power-on, but no images are displayed

- Reason: no images in the STM32E demonstration kit on-board NOR memory
- Solution: refer to [Section 1.4](#) for details

### TFT-LCD image inversion

- Reason : STEVAL-CCM002V1 ESD issues on the analysis jumpers J2, J4
- Solution: avoid bare contact of hands or metallic components on analysis jumpers J2, J4 and restart the kit

Figure 6. STM32 demonstration board connector section for TFT-LCD

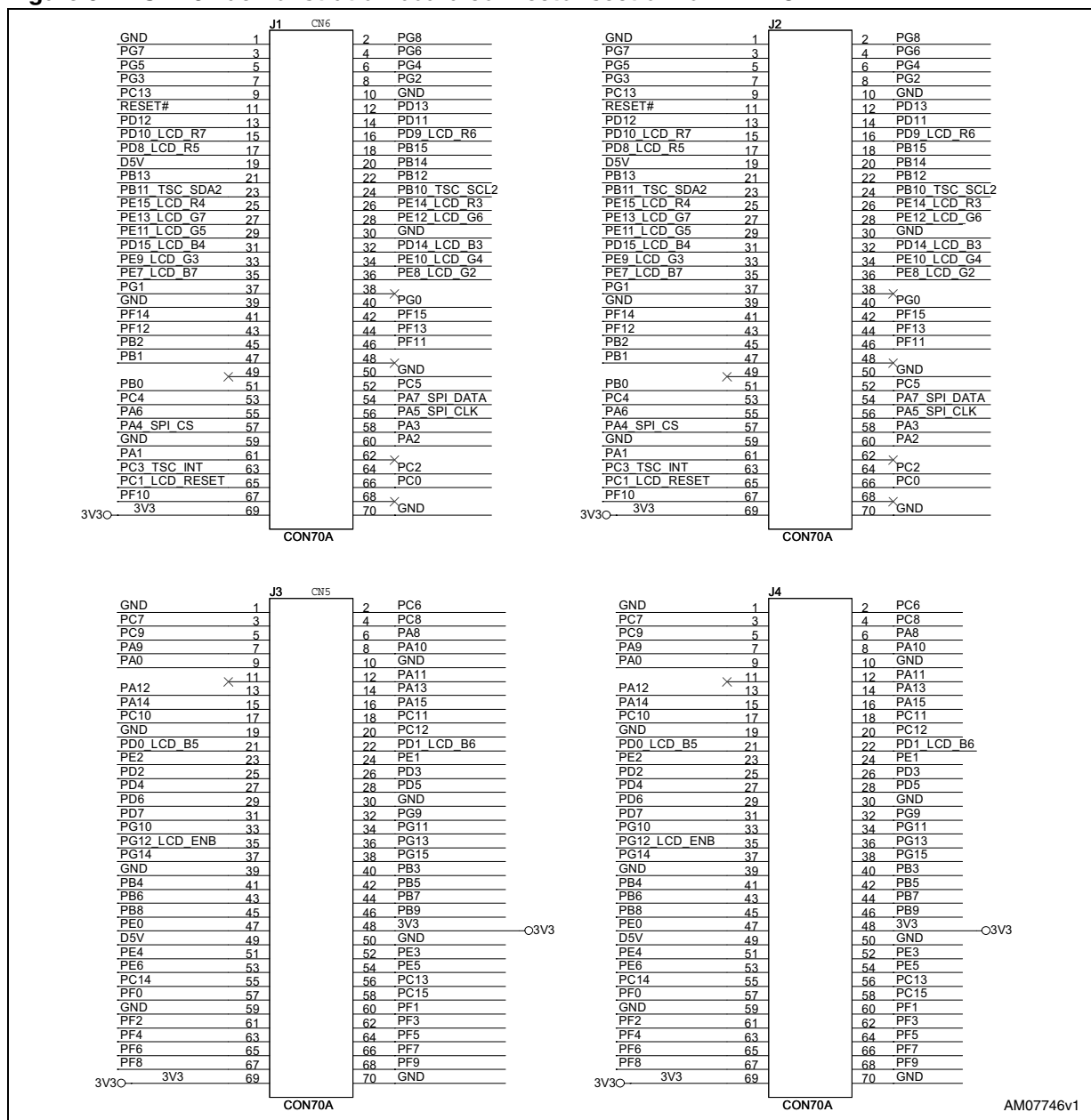

AM07746v1

Figure 7. TFT-LCD 54-pin connector

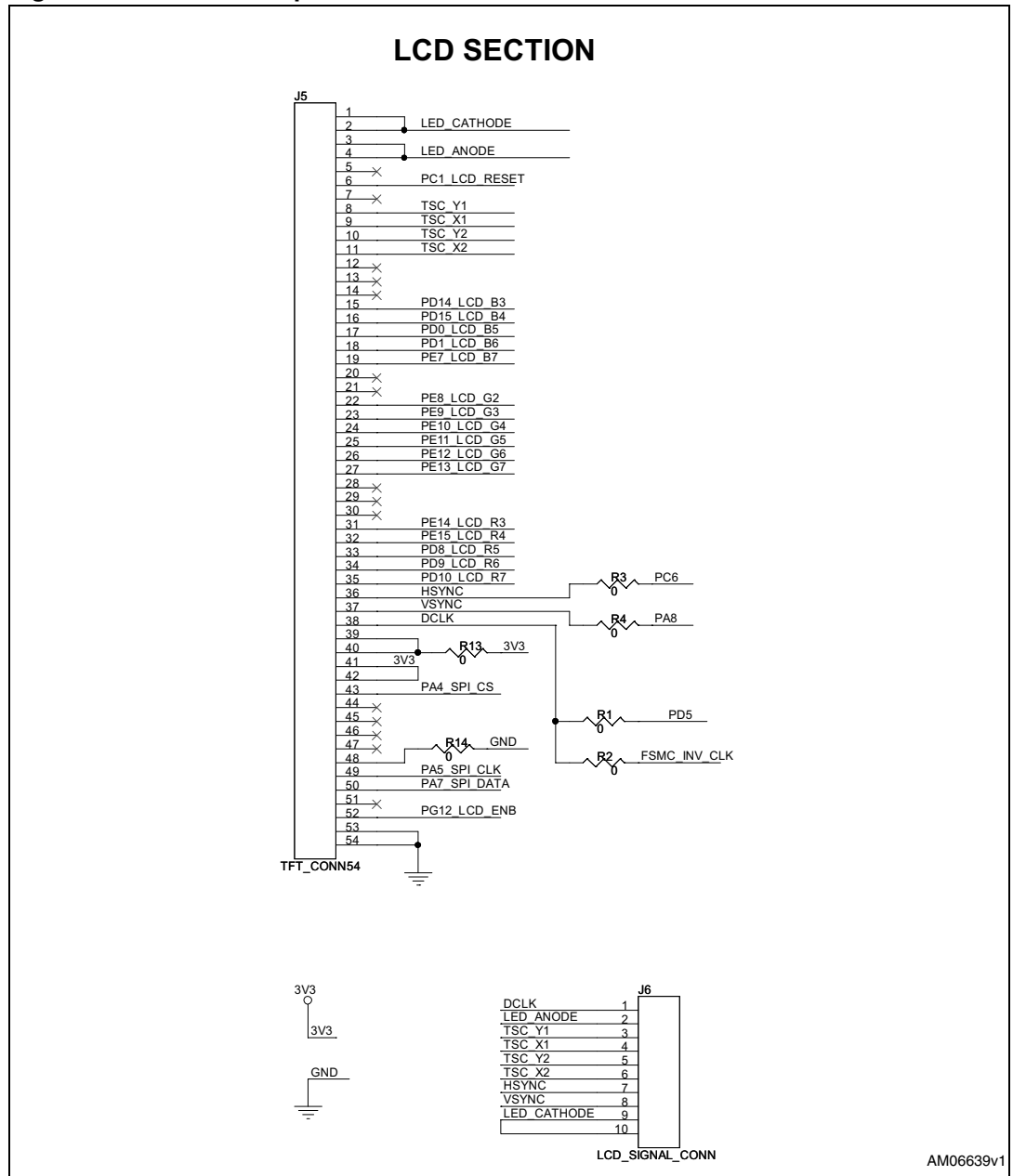

Figure 8. Single-channel inverter and LCD backlight driver

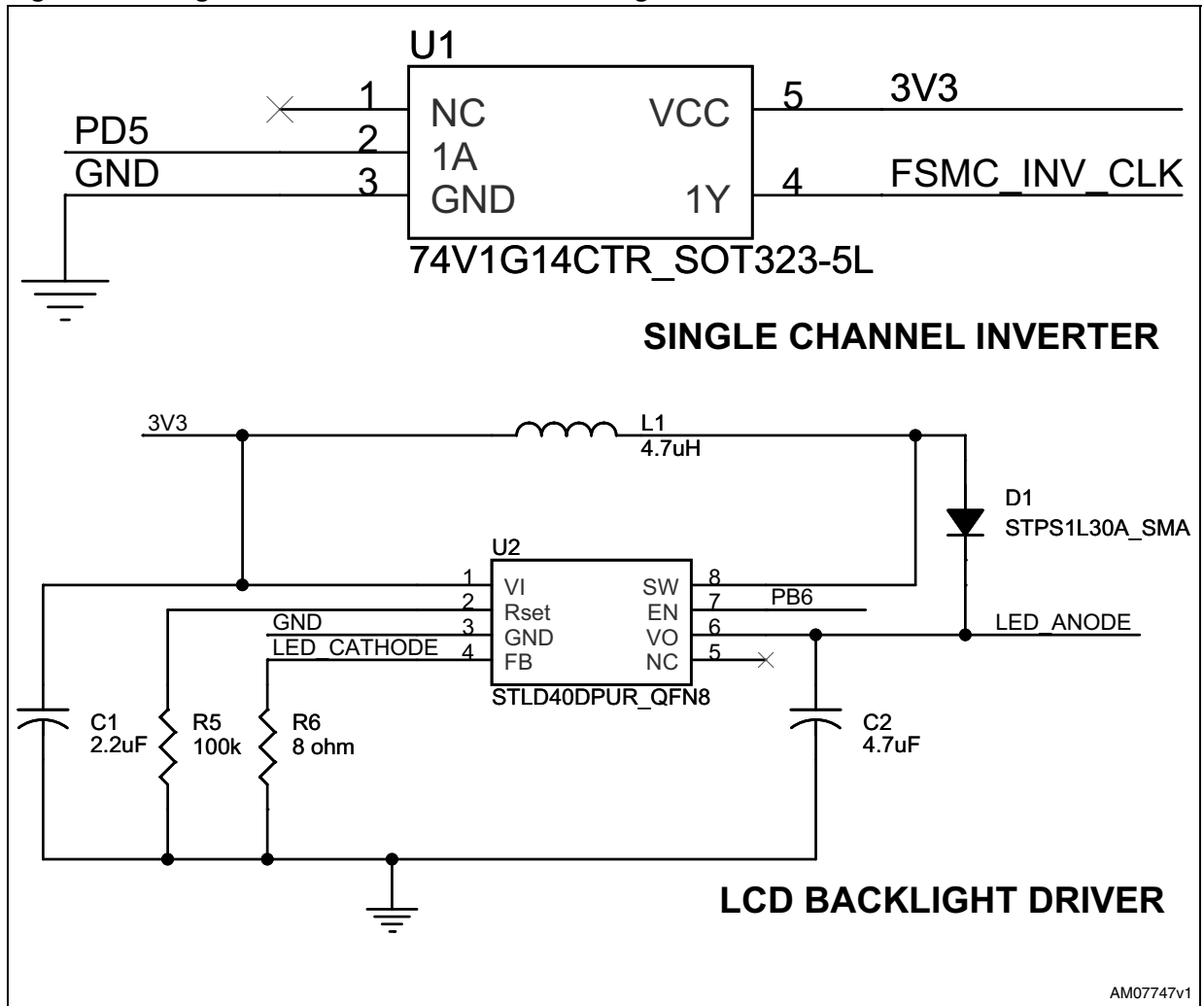
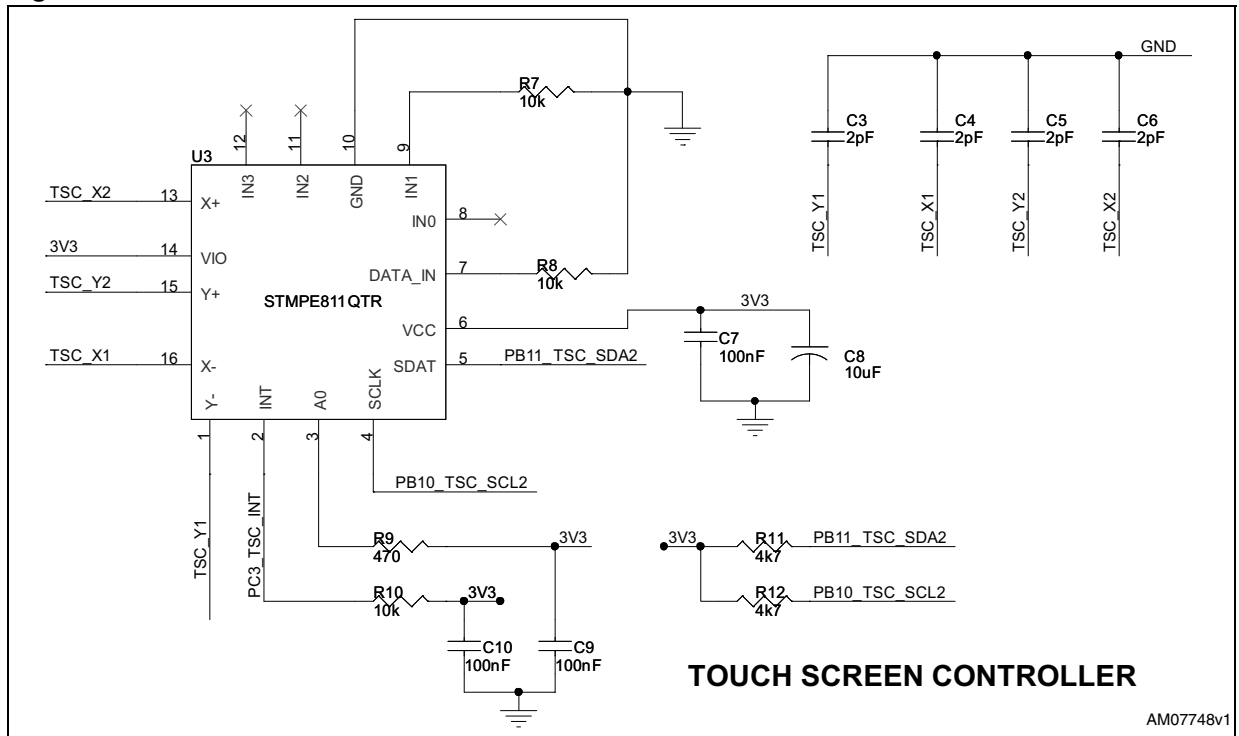

Figure 9. Touchscreen controller



**Table 1. Bill of material (BOM)**

Category	Reference designator	Component description	Package	Manufacturer	Manufacturer's ordering code / orderable part number	Supplier	Supplier ordering code or equivalent
ST devices	U1	Single Schmitt inverter	SOT323-5L	STMicroelectronics	74V1G14CTR		
	U2	White LED power supply for large display backlight	QFN8	STMicroelectronics	STLD40DPUR		
	U3	4-wire resistive touchscreen controller	QFN16	STMicroelectronics	STMPE811QTR		
	D1	Low-drop power Schottky diode	SMA	STMicroelectronics	STPS1L30A		
Display	TFT-LCD	3.5" size, 320 x 240 resolution TFT-LCD	SMD	APEX	CT05350DW0000T		
Connectors and jumpers	J1,J3	Socket 70 PS, 2.54 mm, double row, formed contact, straight, standard 8.5 mm, 2 x 35-way	Socket, 2.54 mm, double row, straight, 2 x 35-way, through-hole	Protectron	P9403-70-21		
	J2,J4	Header 70ps, pin, 2.54 mm, straight 70-way, double row, gold Flash	Double row straight, through-hole, 70-pin, 2 x 35-way	Protectron	P9103-70-12-1		
	J5	54-pin FPC connector 0.5 mm ZIF side-entry SMT	SMD		FPC-GS200-XX1GX-XA	Laptek Marketing	
	J6	Header, pin, 2.54 mm, straight 10-way, single row, gold Flash	Single row straight, through-hole, 40-pin	Protectron	P9101-10-12-1		



**Table 1. Bill of material (BOM) (continued)**

Category	Reference designator	Component description	Package	Manufacturer	Manufacturer's ordering code / orderable part number	Supplier	Supplier ordering code or equivalent
Capacitors	C3,C4,C5,C6	2 pF	Ceramic SMD	Any			
	C7,C9,C10	100 nF	Ceramic SMD	Any			
	C1	2.2 $\mu$ F	Tantulum SMD EIA 3216-18/size A	Any			
	C2	4.7 $\mu$ F /50 V	Tantulum SMD EIA 3216-18/size A	Any			
	C8	10 $\mu$ F/25 V	Tantulum SMD EIA 3216-18/size A	Any			
Resistors	R1,R2,R3,R4 R13,R14	0	SMD0805		Any		
	R6	8 $\Omega$	SMD1206	Vishay/Dale	CRCW12068R06F NEA	Digi-Key	541-8.06FCT-ND
	R9	470 $\Omega$	SMD0805		Any		
	R11,R12	4.7 k $\Omega$	SMD0805		Any		
	R7,R8,R10	10 k $\Omega$	SMD0805		Any		
	R5	100 k $\Omega$	SMD0805		Any		
Inductors	L1	4.7 $\mu$ H	SMD 1210	Murata Electronics North America	LQH32PN4R7NN0L	Digi-Key	490-5338-1-ND

## 6 Revision history

**Table 2. Document revision history**

Date	Revision	Changes
02-Sep-2010	1	Initial release.

**Please Read Carefully:**

Information in this document is provided solely in connection with ST products. STMicroelectronics NV and its subsidiaries ("ST") reserve the right to make changes, corrections, modifications or improvements, to this document, and the products and services described herein at any time, without notice.

All ST products are sold pursuant to ST's terms and conditions of sale.

Purchasers are solely responsible for the choice, selection and use of the ST products and services described herein, and ST assumes no liability whatsoever relating to the choice, selection or use of the ST products and services described herein.

No license, express or implied, by estoppel or otherwise, to any intellectual property rights is granted under this document. If any part of this document refers to any third party products or services it shall not be deemed a license grant by ST for the use of such third party products or services, or any intellectual property contained therein or considered as a warranty covering the use in any manner whatsoever of such third party products or services or any intellectual property contained therein.

**UNLESS OTHERWISE SET FORTH IN ST'S TERMS AND CONDITIONS OF SALE ST DISCLAIMS ANY EXPRESS OR IMPLIED WARRANTY WITH RESPECT TO THE USE AND/OR SALE OF ST PRODUCTS INCLUDING WITHOUT LIMITATION IMPLIED WARRANTIES OF MERCHANTABILITY, FITNESS FOR A PARTICULAR PURPOSE (AND THEIR EQUIVALENTS UNDER THE LAWS OF ANY JURISDICTION), OR INFRINGEMENT OF ANY PATENT, COPYRIGHT OR OTHER INTELLECTUAL PROPERTY RIGHT.**

**UNLESS EXPRESSLY APPROVED IN WRITING BY AN AUTHORIZED ST REPRESENTATIVE, ST PRODUCTS ARE NOT RECOMMENDED, AUTHORIZED OR WARRANTED FOR USE IN MILITARY, AIR CRAFT, SPACE, LIFE SAVING, OR LIFE SUSTAINING APPLICATIONS, NOR IN PRODUCTS OR SYSTEMS WHERE FAILURE OR MALFUNCTION MAY RESULT IN PERSONAL INJURY, DEATH, OR SEVERE PROPERTY OR ENVIRONMENTAL DAMAGE. ST PRODUCTS WHICH ARE NOT SPECIFIED AS "AUTOMOTIVE GRADE" MAY ONLY BE USED IN AUTOMOTIVE APPLICATIONS AT USER'S OWN RISK.**

Resale of ST products with provisions different from the statements and/or technical features set forth in this document shall immediately void any warranty granted by ST for the ST product or service described herein and shall not create or extend in any manner whatsoever, any liability of ST.

ST and the ST logo are trademarks or registered trademarks of ST in various countries.

Information in this document supersedes and replaces all information previously supplied.

The ST logo is a registered trademark of STMicroelectronics. All other names are the property of their respective owners.

© 2010 STMicroelectronics - All rights reserved

STMicroelectronics group of companies

Australia - Belgium - Brazil - Canada - China - Czech Republic - Finland - France - Germany - Hong Kong - India - Israel - Italy - Japan - Malaysia - Malta - Morocco - Philippines - Singapore - Spain - Sweden - Switzerland - United Kingdom - United States of America

[www.st.com](http://www.st.com)