

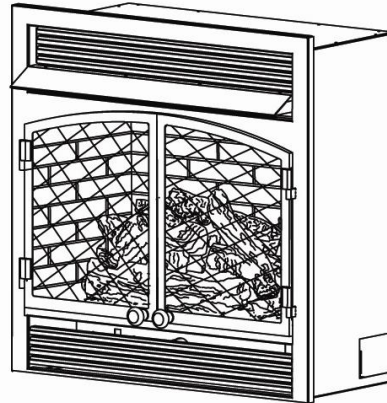

**WARNING:** This appliance is equipped for (Natural and Propane) gas. Field conversion is not permitted other than between natural or propane gases.

**VENT-FREE GAS INSERT**  
MODEL #FBD400RTCC-M-HC/MO/NG  
FBD400TCC-M-HC/MO/NG



**⚠ CAUTION – FOR YOUR SAFETY**

**⚠ WARNING: IF THE INFORMATION IN THIS MANUAL IS NOT FOLLOWED EXACTLY, A FIRE MAY RESULT CAUSING PROPERTY DAMAGE, PERSONAL INJURY, OR LOSS OF LIFE.**

- Do not store or use gasoline or other flammable vapors and liquids in vicinity of this or any other appliance.

**WHAT TO DO IF YOU SMELL GAS**

- Do not try to light any appliance.
- Do not touch any electrical switch; do not use any phone in your building.
- Immediately call your gas supplier from a neighbor's phone. Follow the gas supplier's instructions.
- If you cannot reach your gas supplier, call the fire department.
- Installation and service must be performed by a qualified installer, service agency or the gas supplier.

This is an unvented gas-fired heater. It uses air (oxygen) from the room in which it is installed. Provisions for adequate combustion and ventilation air must be provided. Refer to *Air for Combustion and Ventilation* section on page 7 of this manual.

**INSTALLER: DO NOT DISCARD THIS MANUAL – LEAVE FOR HOMEOWNER'S FUTURE REFERENCE.**

This appliance may be installed in an aftermarket, permanently located manufactured (mobile) home, where not prohibited by local codes. This appliance is for use with the type of gas indicated on the rating plate only. This appliance is not convertible for use with other gases.



**Questions about installation, operation, or troubleshooting?** Before returning to your retailer, contact our customer service department at 1-877-886-5989, 8:00 a.m. - 4:30p.m., EST, Monday-Friday or e-mail [customerservice@usaprocom.com](mailto:customerservice@usaprocom.com).

## TABLE OF CONTENTS

Important Safety Information .....	3
Air For Combustion and Ventilation.....	7
Installation .....	10
Operation.....	17
Care & Maintenance.....	24
Troubleshooting.....	25
Replacement Parts.....	29

**⚠ WARNING: READ THE INSTALLATION & OPERATION INSTRUCTIONS BEFORE USING THIS APPLIANCE.**

**IMPORTANT:** Read instructions and warnings carefully before starting installation. Failure to follow these instructions may result in a possible fire hazard and will void the warranty.

## PRODUCT SPECIFICATIONS

MODEL NO.	FBD400TCC-M-HC/MO/NG		FBD400RTCC-M-HC/MO/NG	
Input Max	32,000 BTU/Hr	32,000 BTU/Hr	32,000 BTU/Hr	32,000 BTU/Hr
Input Min	14,500 BTU/Hr	24,500 BTU/Hr	N/A	N/A
Gas Type	Natural	LP/Propane	Natural	LP/Propane
Ignition	Piezo	Piezo	Piezo	Piezo
Manifold Pressure	4 in. W.C.	9 in. W.C.	4 in. W.C.	9 in. W.C.
Inlet Gas Pressure				
Maximum	10.5 in.	14 in.	10.5 in.	14 in.
Minimum	5 in.	11 in.	5 in.	11 in.
Dimensions, inches (H x W x D)				
Heater	29.5 in. x 29.1 in. x 15.6 in.		29.5 in. x 29.1 in. x 15.6 in.	
Carton	31.1 in. x 31.5 in. x 18.1 in.		31.1 in. x 31.5 in. x 18.1 in.	
Weight, lbs				
Stove	69.5		69.5	
Shipping	79.5		79.5	

## IMPORTANT SAFETY INFORMATION

**IMPORTANT:** Read this owner's manual carefully and completely before trying to assemble, operate, or service this heater. Improper use of this heater can cause serious injury or death from burns, fire, explosion, electrical shock, and carbon monoxide poisoning.

Only a qualified installer, service agent, or local gas supplier may install and service this product.

**⚠ WARNING:** Do not store or use gasoline or other flammable vapors or liquids in the vicinity of this or any other appliance.

**⚠ WARNING:** This appliance is for use with only the type of gas indicated on the rating plate. This appliance is not convertible for use with other gases.

**CARBON MONOXIDE POISONING:** Early signs of carbon monoxide poisoning resemble the flu with headaches, dizziness, or nausea. If you have these signs, the heater may not be working properly. Get fresh air immediately! Have heater serviced. Some people are more affected by carbon monoxide than others. These include pregnant women, people with heart or lung disease, people who are anemic, those under the influence of alcohol, and those living at high altitudes.

**NATURAL AND PROPANE/LP GAS:** Natural and Propane/LP gases are odorless. An odor-making agent is added to the gas. The odor helps you detect a gas leak. However, the odor added to the gas can fade. Gas may be present even though no odor exists. Make certain you read and understand all warnings. Keep this manual for reference. It is your guide to operating this heater safely.

**⚠ WARNING:** Any change to this fireplace or its controls can be dangerous.

**⚠ WARNING:** Do not allow fans or any other drafts that alter burner flame to blow directly into the heater. They create drafts that alter burner flame patterns, which can cause sooting.

**⚠ WARNING:** Do not use a blower insert, heat exchange insert, or other accessory not approved for use with this heater.

Due to high temperatures, the appliance should be located out of traffic and away from furniture and draperies. Do not place clothing or other flammable material on or near the appliance. Never place any objects in the heater. Heater becomes very hot when running heater. Keep children and adults away from hot surfaces to avoid burns or clothing ignition. Fireplace will remain hot for a time after shutdown. Allow surfaces to cool before touching. Carefully supervise young children when they are in the room with the heater.

You must operate this heater with the heater screen in place. Keep the heater area clear and free from combustible materials, gasoline, and other flammable vapors and liquids.

1. Do not place Propane/LP supply tank(s) inside any structure. Propane/LP supply tank(s) must be placed outdoors.
2. This heater needs fresh air ventilation to run properly. This heater has an Oxygen Depletion Sensing (ODS) safety shutoff system. The ODS shuts down the heater if not enough fresh air is available. See *Air for Combustion and Ventilation*, pages 7 through 9. If heater keeps shutting off, see *Troubleshooting*, pages 25 through 27.
3. Keep all air openings in front and bottom of heater clear and free of debris. This will ensure enough air for proper combustion.
4. If heater shuts off. Do not relight until you provide fresh, outside air. If heater keeps shutting off, have it serviced.
5. Do not run heater:
  - Where flammable liquids or vapors are used or stored.
  - Under dusty conditions.
6. Before using furniture polish, wax, carpet cleaner, or similar products, turn heater off. If heated, the vapors from these products may create a white powder residue within burner box or on adjacent walls or furniture.

7. Always run heater with control knob at PILOT/IGN, LOW or HIGH locked positions. Never set control knob between locked positions. Poor combustion and higher levels of carbon monoxide may result.
8. Do not use heater if any part has been under water. Immediately call a qualified service technician to inspect the room heater and to replace any part of the control system and any gas control which has been under water.
9. Turn off and unplug heater and let cool before servicing. Only a qualified service person should service and repair heater.
10. Operating heater above elevations of 4,500 feet could cause pilot outage.
11. To prevent performance problems, do not use propane/LP fuel tank of less than 100 lbs. capacity.
12. This heater should not be installed in a bedroom or bathroom.
13. Do not use this heater as a wood-burning heater. Use only the logs provided with the heater.
14. To prevent the creation of soot, follow the instructions in *Care and Maintenance* (page 24).
15. Do not add extra logs or ornaments such as pine cones, vermiculite, or rock wool. Using these added items can cause sooting. Do not add lava rock around base. Rock and debris could fall into the control area of heater. After servicing, always replace screen before operating heater.
16. This heater is designed to be smokeless. If logs ever appear to smoke, turn off heater and call a qualified service person. Note: During initial operation, slight smoking could occur due to log curing and the heater burning manufacturing residues.

#### **QUALIFIED INSTALLING AGENCY**

Installation and replacement of gas piping, gas utilization equipment or accessories and repair and servicing of equipment shall be performed only by a qualified agency. The term "qualified agency" means any individual, firm, corporation, or company that either in person or through a representative is engaged in and is responsible for:

- a) Installing, testing, or replacing gas piping or
- b) Connecting, installing, testing, repairing, or servicing equipment; that is experienced in such work; that is familiar with all precautions required; and that has complied with all the requirements of the authority having jurisdiction.

## PRODUCT FEATURES

### SAFETY PILOT

This heater has a pilot with an Oxygen Depletion Sensing (ODS) safety shutoff system. ODS/pilot shuts off the heater if there is not enough fresh air.

### PIEZO IGNITION SYSTEM

Heater is equipped with an electronic piezo control system. This system requires 1 AAA battery (provided).

### THERMOSTAT HEAT CONTROL

The control automatically cycles the burner on and off to maintain a desired room temperature. See page 19.

### DUAL FUEL CAPABLE

Your heater is equipped to operate on either Propane or Natural gas. The heater is shipped from the factory ready for connecting to Propane. The heater can easily be changed to Natural gas by having your qualified installer follow the instructions on page 12 & 13 and the markings on the heater.

**State of Massachusetts:** The installation must be made by a licensed plumber or gas fitter in the Commonwealth of Massachusetts. Sellers of unvented propane or natural gas-fired supplemental room heaters shall provide to each purchaser a copy of 527 CMR 30 upon sale of the unit.

In the State of Massachusetts, unvented propane or natural gas-fired space heaters shall be prohibited in bedrooms and bathrooms.

**In the State of Massachusetts the gas cock must be a T-handle type. The State of Massachusetts requires that a flexible appliance connector cannot exceed three feet in length.**

### LOCAL CODES

Install and use heater with care. Follow all codes. In the absence of local codes, use the latest edition of *The National Fuel Gas Code*, ANSI Z223.1, also known as NFPA 54\*.

\*Available from:

American National Standards Institute, Inc.  
1430 Broadway  
New York, NY 10018

National Fire Protection Association, Inc.  
1 Battery march Park  
Quincy, MA 02269-9101

This heater is designed for vent-free operation. State and local codes in some areas prohibit the use of vent-free heaters.

## UNPACKING

1. Remove top inner pack
2. Tilt carton so that heater is upright.
3. Remove protective side packaging.
4. Slide heater out of carton.
5. Remove protective plastic wrap.
6. Hold the screen lift and pull forward.
7. Remove log set by cutting plastic.
8. Carefully un-wrap log.
9. Check for any shipping damage. If stove or log is damaged, promptly inform your dealer where you bought the heater.

## PRODUCT IDENTIFICATION

Figure 1

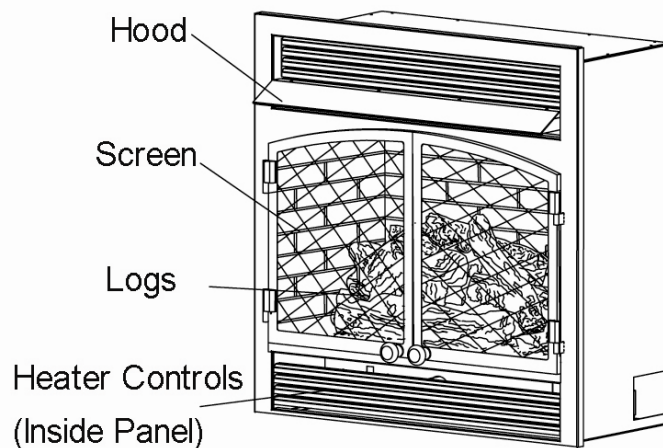

## WATER VAPOR: A BY-PRODUCT OF UNVENTED ROOM HEATERS

Water vapor is a by-product of gas combustion. An unvented room heater produces approximately one (1) ounce (30ml) of water for every 1,000 BTUs (.3kW) of gas input per hour. An unvented room heater is recommended as a supplemental heater (a room) rather than a primary heat source (an entire house). In most supplemental heat applications, the water vapor does not create a problem. In most applications, the water vapor enhances the low humidity atmosphere experienced during cold weather. The following steps will help insure that water vapor does not become a problem:

1. Be sure the heater is the proper size for the application, including adequate combustion air and circulation air.
2. If there is high humidity, the dehumidifier may be used to help lower the water vapor content of the air.
3. Do not use an unvented room heater as the primary heat source.

## AIR FOR COMBUSTION AND VENTILATION

**⚠ WARNING:** This heater should not be installed in a confined space or unusually tight construction unless provisions are provided for adequate combustion and ventilation air. Read the following instructions to insure proper fresh air for this and other fuel-burning appliances in your home.

### PRODUCING ADEQUATE VENTILATION

The following are excerpts from National Fuel Gas Code, NFPA 54/ANSI Z223.1, Section 5.3, Air for Combustion and Ventilation. All spaces in homes fall into one of the three following ventilation classifications:

1. Unusually Tight Construction
2. Unconfined Space
3. Confined Space

The information on pages 8 through 10 will help you classify your space and provide adequate ventilation.

### Confined and Unconfined Space

*The National Fuel Gas Code, ANSI Z223.1* defines a confined space as a space whose volume is less than 50 cubic feet per 1,000 BTU per hour (4.8 cubic meters per kw) of the aggregate input rating of all appliances installed in that space and an unconfined space as a space whose volume is not less than 50 cubic feet per 1,000 BTU per hour (4.8 cubic meters per kw) of the aggregate input rating of all appliances installed in that space. Rooms communicating directly with the space in which the appliances are installed\*, through openings not furnished with doors, are considered a part of the unconfined space.

This heater shall not be installed in a confined space or unusually tight construction unless provisions are provided for adequate combustion and ventilation air.

- Adjoining rooms are connecting only if there are door less passageways or ventilation grills between them

### Unusually Tight Construction

The air that leaks around doors and windows may provide enough fresh air for combustion and ventilation. However, in buildings of unusually tight construction, you must provide additional fresh air.

### Unusually tight construction is defined as construction where:

- a) walls and ceilings exposed to the outside atmosphere have a continuous water vapor retarder with a rating of one perm ( $6 \times 10^{-11}$  kg per pa-sec-m<sup>2</sup>) or less with openings gasketed or sealed and
- b) Weather stripping has been added on windows that can be opened and on doors and
- c) Caulking or sealants are applied to areas such as joints around window and door frames, between sole plates and floors, between wall-ceiling joints, between wall panels, at penetrations for plumbing, electrical, and gas lines, and at other openings.

If your home meets all of the three criteria above, you must provide additional fresh air. See "Ventilation Air from Outdoors" (page 9). If your home does not meet all of the three criteria above, proceed to "Determining Fresh-Air Flow for Heater Location":

## DETERMINING FRESH-AIR FLOW FOR HEATER LOCATION

### Determining if You Have a Confined or Unconfined Space

Use this worksheet to determine if you have a confined or unconfined space.

**Space:** Includes the room in which you will install heater plus any adjoining rooms with door less passageways or ventilation grills between the rooms.

1. Determine the volume of the space  $\text{Length} \times \text{Width} \times \text{Height} = \text{cu. ft. (volume of space)}$

*Example:* Space size 20 ft. (length)  $\times$  16 ft. (width)  $\times$  8 ft. (ceiling height) = 2560 cu. ft. (volume of space)

If additional ventilation to adjoining room is supplied with grills or openings, add the volume of these rooms to the total volume of the space.

2. Divide the space volume by 50 cubic feet to determine the maximum BTU/hr the space can support.

$\frac{\text{Volume of space}}{50 \text{ cu. ft.}} = \text{(Maximum BTU/hr the space can support)}$

*Example:*  $\frac{2560 \text{ cu. ft. (volume of space)}}{50 \text{ cu. ft.}} = 51.2$  or 51,200 (maximum BTU/hr the space can support)

3. Add the BTU/hr of all fuel burning appliances in the space.

Vent-free heater	_____	BTU/hr		
Gas water heater*	_____	BTU/hr		
Gas furnace	_____	BTU/hr		
Vented gas heater	_____	BTU/hr	Example:	
Gas heater logs	_____	BTU/hr	Gas water heater	30,000 BTU/hr
Other gas appliances*+	_____	BTU/hr	Vent-free heater	+ 26,000 BTU/hr
Total	= _____	BTU/hr	Total	= 56,000 BTU/hr

\*Do not include direct-vent gas appliances. Direct-vent draws combustion air from the outdoors and vents to the outdoors.

4. Compare the maximum BTU/hr the space can support with the actual amount of BTU/hr used.

BTU/hr (maximum the space can support)

BTU/hr (actual amount of BTU/hr used).

*Example:* 51,200 BTU/hr (maximum the space can support)

56,000 BTU/hr (actual amount of BTU/hr used)

The space in the above example is a confined space because the actual BTU/hr used is more than the maximum BTU/hr the space can support. You must provide additional fresh air. Your options are as follows:

- a) Rework worksheet, adding the space of an adjoining room. If the extra space provides an unconfined space, remove door to adjoining room or add ventilation grills between rooms. See "Ventilation Air from Outdoors," page 9.
- b) Vent room directly to the outdoors. See "Ventilation Air from Outdoors", Page 9.
- c) Install a lower BTU/hr heater if lower BTU/hr size makes room unconfined. If the actual BTU/hr used is less than the maximum BTU/hr the space can support, the space is an unconfined space. You will need no additional fresh air ventilation.

**WARNING:** If the area in which the heater may be operated is smaller than that defined as an unconfined space or if the building is of unusually tight construction, provide adequate combustion and ventilation air by one of the methods described in the *National Fuel Gas Code, ANSI Z223.1/NFPA 54, Air for Combustion and Ventilation*, or applicable local codes.



## Ventilation Air from Inside Building

This fresh air would come from adjoining unconfined space. When ventilating to an adjoining unconfined space, you must provide two permanent openings: one within 12 inches of the wall connecting the two spaces ( see options 1 and 2, Figure 2 ). You can also remove door into adjoining room ( see option 3, Figure 2 ). Follow the National Fuel Gas Code NFPA 54/ANSI Z223.1. *Air for Combustion and Ventilation* for required size of ventilation grills or ducts.

Figure 2 - Ventilation Air from Inside Building

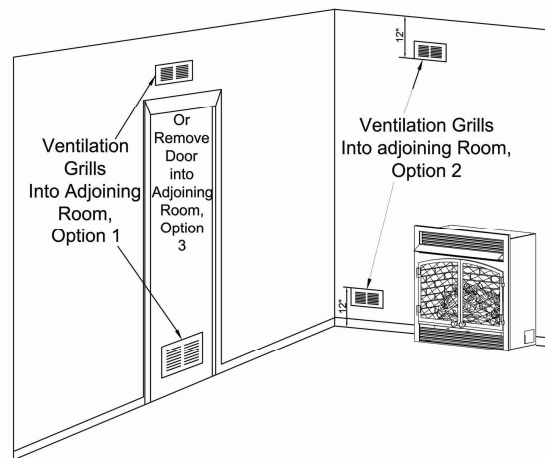

## Ventilation Air from Outdoors

Provide extra fresh air by using ventilation grills or duct. You must provide two permanent openings: one within 12 inches of the ceiling and one within 12 inches of the floor. Connect these items directly to the outdoors or spaces open to the outdoors. These spaces include attics and crawl spaces. Follow the National Fuel Gas Code NFPA 54/ANSI Z223.1. *Air for Combustion and Ventilation* for required size of ventilation grills or ducts.

Figure 3 - Ventilation Air from Outdoors Building

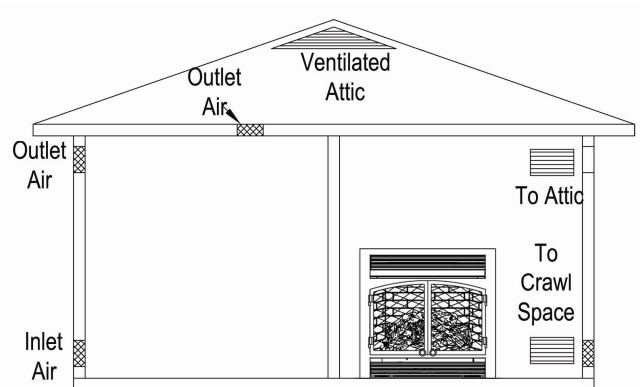

**⚠ IMPORTANT:** Do not provide openings for inlet or outlet air into attic if attic has a thermostat-controlled power vent. Heated air entering the attic will activate the power vent. Rework worksheet, adding the space of the adjoining unconfined space. The combined spaces must have enough fresh air to supply all appliances in both spaces.

## INSTALLATION

**⚠ NOTICE:** This heater is intended for use as supplemental heat. Use this heater along with your primary heating system. Do not install this heater as your primary heat source. If you have a central heating system, you may run system's circulating blower while using heater. This will help circulate the heat throughout the house.

**⚠ WARNING:** A qualified technician must install heater. Follow all local codes.

**⚠ WARNING:** Never install the heater

- in a bedroom or bathroom
- in a recreational vehicle
- Where curtains, furniture, clothing, or other flammable objects are less than 42 inches from the front, top or sides of the heater.
- in high traffic areas
- in windy or drafty areas

**⚠ CAUTION:** This heater creates warm air currents. These currents move heat to wall surfaces next to heater. Installing heater next to vinyl or cloth wall coverings or operating heater where impurities (such as tobacco smoke, aromatic candles, cleaning fluids, oil or kerosene lamps, etc.) in the air exist, may cause walls to discolor.

**⚠ WARNING:** Maintain the minimum clearances. If you can, provide greater clearances from floor, ceiling and adjoining side and back walls.

**IMPORTANT:** Vent-free heaters add moisture to the air. Although this is beneficial, installing heater in rooms without enough ventilation air may cause mildew to form from too much moisture. See *Air for Combustion and Ventilation*, pages 7 through 9.

### CHECK GAS TYPE

Use only the type of gas indicated on the plate. If your gas supply cannot meet that requirement, do not install heater.

### CLEARANCES TO COMBUSTIBLES

Carefully follow the instructions below. This heater is a wall mount unit designed to mount directly on a wall.

**IMPORTANT:** You must maintain minimum wall and ceiling clearances during installation. The minimum clearances are shown in Figure 4. Measure from outermost point of heater.

#### Minimum Wall and Ceiling Clearances (see Figure 4)

- A. Clearances from outermost point of heater to any combustible side wall should not be less than 12 inches.
- B. Clearances from the heater to the ceiling should not be less than 48 inches.

Figure 4 – Minimum Clearance to Wall and Ceiling

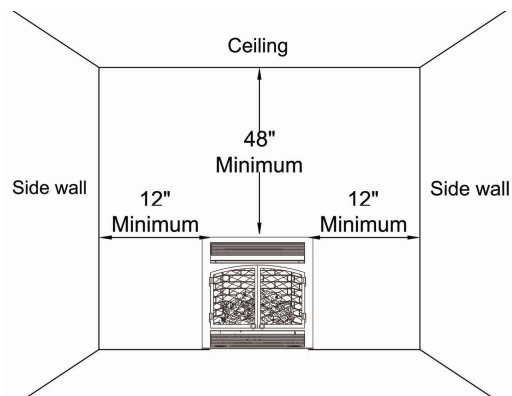

## CONNECTING TO GAS SUPPLY

**⚠ WARNING:** A qualified technician must connect heater to gas supply. Follow all local codes.

**⚠ WARNING:** This appliance requires a 3/8 in. NPT inlet connection to pressure regulator (see Figure 5).

**CAUTION:** Never connect heater directly to the gas supply. This heater requires an external regulator (not supplied). The external regulator between the gas supply and heater must be installed.

## INSTALLATION ITEMS NEEDED

Before installing heater, make sure you have the items listed below.

- piping (check local codes)
- sealant (resistant to propane/LP gas)
- equipment shutoff valve\*
- test gauge connection\*\*
- sediment trap
- tee joint
- pipe wrench
- Flexible Gas hose (check local code)

A CSA design-certified equipment shutoff valve with 1/8 in. NPT tap is an acceptable alternative to test gauge connection. Purchase the optional CSA design certified equipment shutoff valve from your dealer.

**⚠ WARNING:** Never connect heater to private (non-utility) gas wells. This gas is commonly known as wellhead gas.

The installer must supply an external regulator. The external regulator will reduce incoming gas pressure. You must reduce incoming gas pressure to between 11 and 14 inches of water column for propane and between 5 and 10.5 inches of water column for natural gas. If you do not reduce incoming gas pressure, heater regulator damage could occur. Install external regulator with the vent pointing down as shown in Figure 6. Pointing the vent down protects it from freezing rain or sleet.

Figure 5 - Gas Regulator Location and Gas Line Access into Stove Cabinet

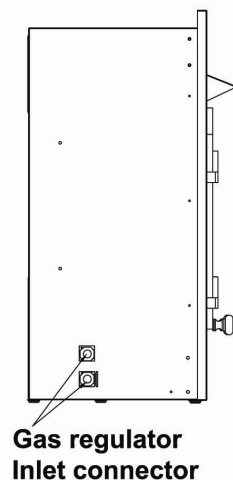
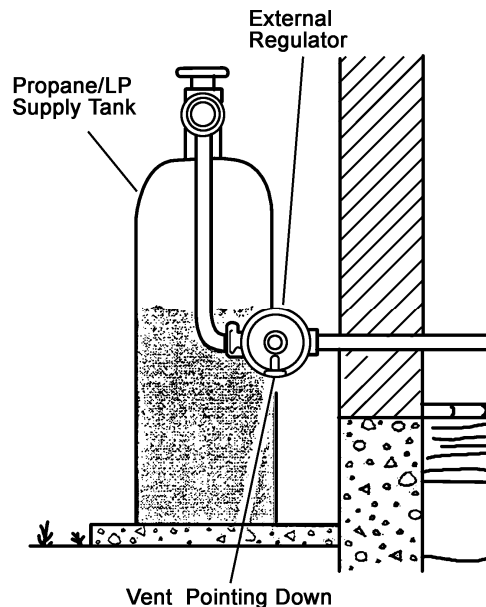

Figure 6 - External Regulator With Vent Pointing Down



**⚠ CAUTION:** Use only new black iron or steel pipe. Internally tinned copper tubing may be used in certain areas. Check your local codes. Use pipe of ½ inch diameter or greater to allow proper volume gas to heater. If pipe is too small, loss of pressure will occur. Installation must include an equipment shutoff valve, union, and plugged 1/8-inch NPT tap. Locate NPT tap within reach for test gauge hook up. NPT tap must be upstream from heater (see Figure 7).

**IMPORTANT:** Install equipment shutoff valve in an accessible location. The equipment shutoff valve is for turning on or shutting off the gas to the appliance. Apply pipe joint sealant lightly to male threads. This will prevent excess sealant from going into pipe. Excess sealant in pipe could result in clogged heater valves.

**⚠ CAUTION:** Use pipe joint sealant that is resistant to gas (PROPANE or NG). We recommend that you install a sediment trap in a supply line as shown in Figure 7. Locate sediment trap where it is within reach for cleaning and not likely to freeze. Install in the piping system between fuel supply and heater. A sediment trap traps moisture and contaminants. This keeps them from going into heater controls. If sediment trap is not installed or is installed incorrectly, heater may not run properly.

**⚠ CAUTION:** Avoid damage to regulator. Hold gas regulator with wrench when connecting into gas piping and/or fittings. NG Models: 5 in. to 10.5 in. W.C. Gas supplier provide external regulator for natural gas.

Figure 7 – Gas Connection

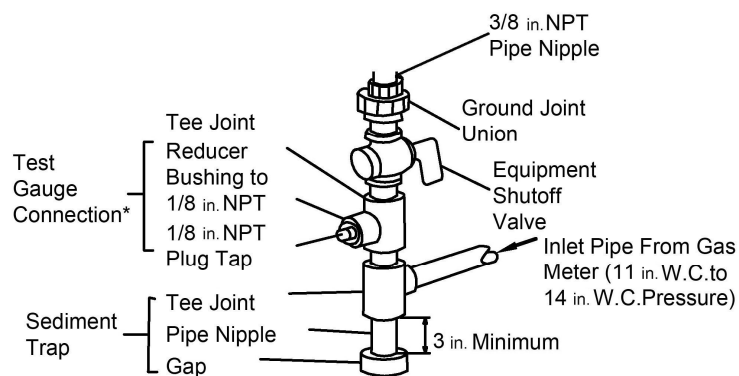

\*Purchase the optional CSA design-certified equipment shut off valve from your dealer. See "Accessories".

**CAUTION:** Two gas line installations at the same time are forbidden. You are not allowed to open the cover while the machine is running.

Heater is pre-set at factory for propane gas, no changes are required for connecting to propane. Only a qualified installer or service technician can perform gas selection and connecting to gas supply.

**⚠ CAUTION:** To avoid gas leakage at the inlet of regulator, a qualified installer or service technician must use steel or metal hex plug with sealant.

### For changing from propane to natural gas supply

1. Remove bottom screw from cover plate, see Figure 8, and rotate to expose gas selection valve.
2. For NATURAL GAS, press in knob using a flat screwdriver with a blade the width of a quarter and turn knob clockwise  until the knob locks into the NG position (see Figure 9). Selection valve must be locked into the NG position. Do not operate heater between locked positions!
3. Rotate and close cover over gas selection valve and reinstall screw.
4. Remove steel or metal hex plug (with wrench provided) from natural gas inlet of regulator and install into LP inlet of regulator, use thread sealant to assure there are no leaks.

### For changing from natural gas supply to propane supply

1. Remove bottom screw from cover plate, see figure 8, and rotate to expose gas selection valve.
2. For PROPANE GAS, press in knob using a flat screw driver with a blade the width of a quarter and turn knob counterclockwise  until the knob locks into the LP position (see Figure 10). Selection valve must be locked into either the LP position or the NG position.
3. Rotate and close cover over gas selection valve and reinstall screw.
4. Remove hex plug from LP gas inlet of regulator and install into NG inlet of regulator, use thread sealant to assure there are no leaks.

Figure 8

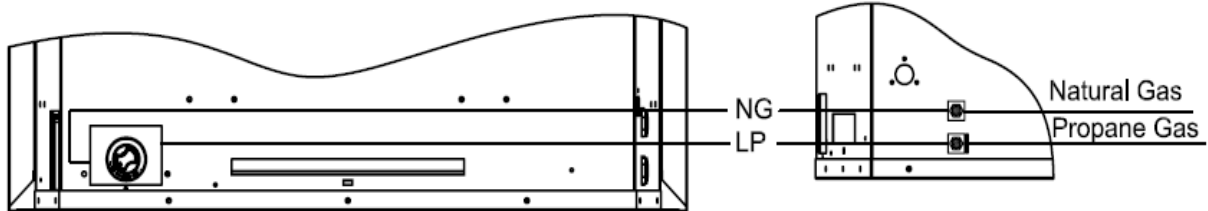

Figure 9

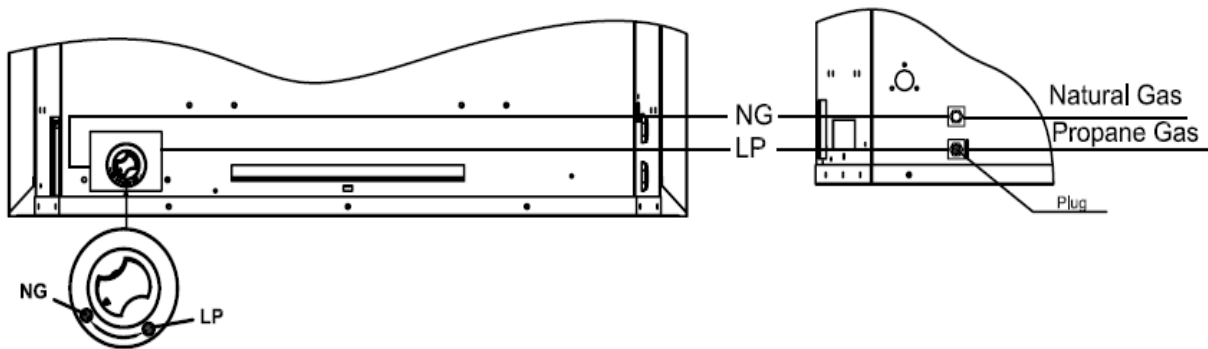
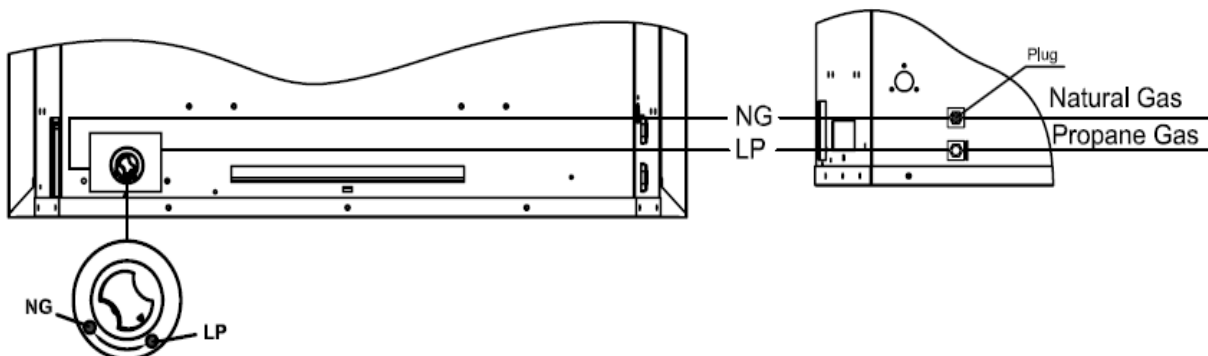

Figure 10



## CHECKING GAS CONNECTIONS

**⚠ WARNING:** Test all gas piping and connections for leaks after installing or servicing. Correct all leaks immediately.

**⚠ WARNING:** Never use an open flame to check for a leak. Apply a mixture of liquid soap and water to all joints. Bubbles forming show a leak. Correct all leaks immediately.

**⚠ CAUTION:** Make sure external regulator has been installed between gas supply and heater. See guidelines under “Connecting to Gas Supply” (page 12).

### Pressure Testing Gas Supply Piping System Test Pressures In Excess Of 1/2 PSIG (3.5kPa)

1. Disconnect heater with its appliance main gas valve (control valve) and equipment shutoff valve from gas supply piping system. Pressures in excess of 1 / 2 psig will damage heater regulator.
2. Cap off open end of gas pipe where equipment shutoff valve was connected.
3. Pressurize supply piping system by either using compressed air or opening gas supply tank valve.
4. Check all joints of gas supply piping system. Apply mixture of liquid soap and water to gas joints. Bubbles forming show a leak.
5. Correct all leaks immediately.
6. Reconnect heater and equipment shutoff valve to gas supply. Check reconnected fittings for leaks.

### Test Pressures Equal To or Less Than 1/2 PSIG (3.5 kPa)

1. Close equipment shutoff valve (see Figure 11).
2. Pressure supply piping system by either using compressed air or opening gas supply tank valve.
3. Check all joints from gas meter to equipment shutoff valve (see Figure 12). Apply mixture of liquid soap and water to gas joints. Bubbles forming show a leak.
4. Correct all leaks immediately.

### Pressure Testing Heater Gas Connections

1. Open equipment shutoff valve (see Figure 11).
2. Open gas supply tank valve.
3. Make sure control knob of heater is in the OFF position.
4. Check all joints from equipment shutoff valve to control valve (Figure 12). Apply mixture of liquid soap and water to gas joints. Bubbles forming show a leak.
5. Light heater (see *Operation*, page 17). Check all other Internal joints for leaks.
6. Turn off heater (see *To Turn off Gas to Appliance*, Page 19).

Figure 11 – Equipment Shutoff Valve

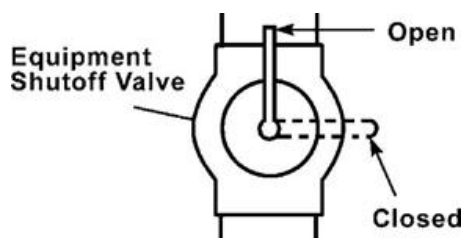
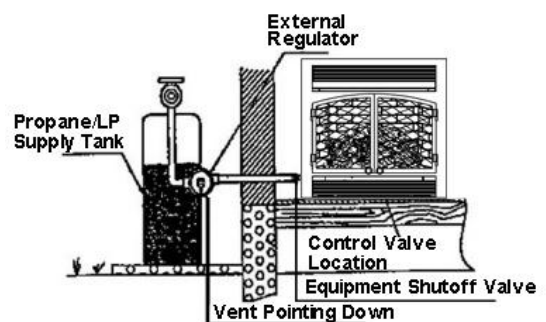

Figure 12- Checking Gas Joints



## INSTALLING LOGS

**⚠ WARNING:** Failure to position the parts in accordance with these diagrams or failure to use only parts may result in property damage or personal injury.

**⚠ CAUTION:** After installation and periodically thereafter, check to ensure that no flame comes in contact with any log. With the heater set to high, check to see if flames contact any log. If so, reposition logs according to the log installation instructions in this manual. Flames contacting logs will create soot.

Figure 13-Installing Log Set

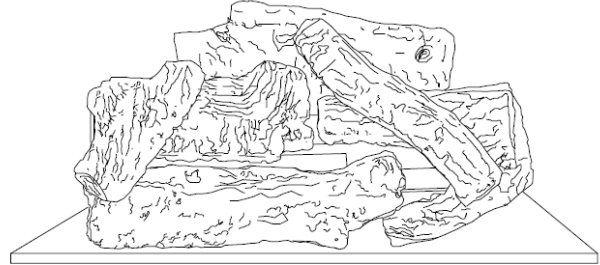

**IMPORTANT:** Make sure log does not cover any burner ports (see Figure 13). It is very important. To install the logs exactly as instructed. Do not modify logs. Only use logs supplied wall heater.

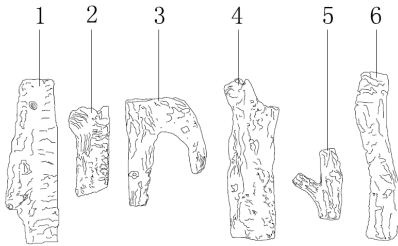

All logs

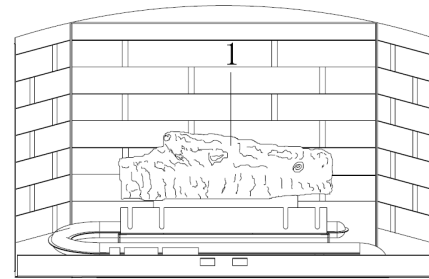

**STEP 1:** Install log 1 onto the two slots in middle plate.

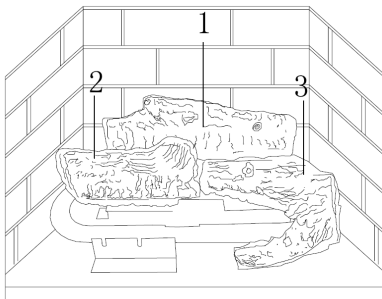

**STEP 2:** Install log 2 onto the two slots in left plate. And install log 3 onto the two slots in right plate.

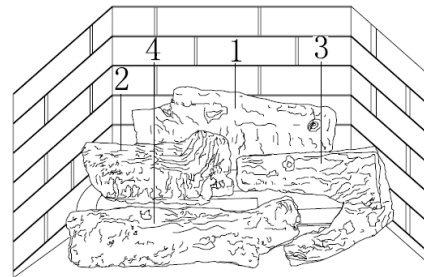

**STEP 3:** Install log 4 onto the two slots in front plate.

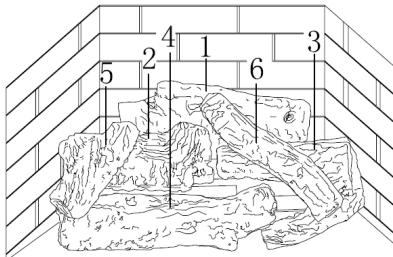

**STEP 4:** Insert the recessed holes bottom of log 5 onto the pins on log 2 and 4. Insert the recessed holes bottom of log 6 onto the pins on log 1 and 3.

## Installation for Remote Receiver:

The remote receiver operates on four AA-size batteries. It is recommended that ALKALINE batteries be used for longer battery life and maximum microprocessor performance.

**IMPORTANT:** New or fully charged batteries are essential for proper operation of the remote receiver as the solenoid power consumption is higher than standard remote control systems.

1. Take Control Box out from Control Panel. (See Figure 14 )
2. Remove battery cover along the direction showed on the battery box, and install four (4) AA batteries into the box. (See Figure 15 )

Figure 14

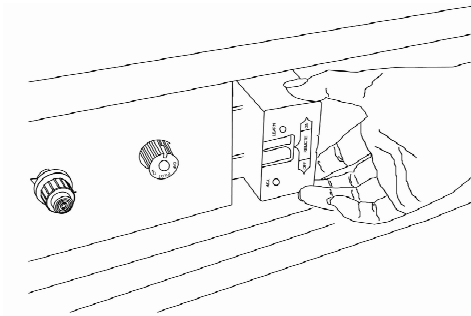
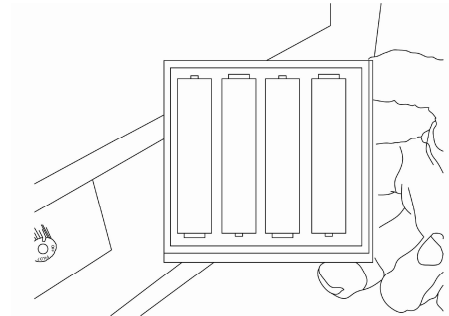

Figure 15



**NOTE:** This equipment has been tested and found to comply with the limits for Class B digital device, pursuant to part 15 of the FCC Rules. These limits are designed to provide reasonable protection against harmful interference in a residential installation. This equipment generates uses and can radiate radio frequency energy and, if not installed and used in accordance with the instructions, may cause harmful interference to radio or television reception, which can be determined by turning the equipment off and on, the user is encouraged to try to correct the interference by one or more of the following measures:

- Reorient or relocate the receiving antenna.
- Increase the separation between the equipment and the receiver.
- Connect the equipment into an outlet on a circuit different from that to which the receiver is connected.
- Consult the dealer or an experienced radio/TV technician for help.



## OPERATION

### FOR YOUR SAFETY READ BEFORE LIGHTING

**⚠ WARNING:** If you do not follow these instructions exactly, a fire or explosion may result causing property damage, personal injury or loss of life.

**⚠ NOTICE:** During initial operation of new heater, burning logs will give off a paper burning smell. Orange flame will also be present. Open a window to vent smell. This will last only few hours.

**⚠ CAUTION:** Do not try to adjust heating levels by using the equipment shutoff valve.

- A. This appliance has a pilot which must be lit by the electronic ignitor. When lighting the pilot, follow these instructions exactly.
- B. BEFORE LIGHTING smell all around the appliance area for gas. Be sure to smell next to the floor because some gas is heavier than air and will settle on the floor.

### WHAT TO DO IF YOU SMELL GAS

- Do not try to light any appliance.
  - Do not touch any electrical switch; do not use any phone in your building.
  - Immediately call your gas supplier from a neighbor's phone. Follow the gas supplier's instructions.
  - If you cannot reach your gas supplier, call the fire department
- C. Use only your hand to push control. Never use tools. If the appliance does not operate, don't try to repair it. Call a qualified service technician or gas supplier. Forced or attempted repair may result in fire or explosion.
  - D. Do not use this appliance if any part has been under water. Immediately call a qualified service technician to inspect the appliance and to replace any part of the control system and any gas control, which has been under water.

**Note:** Please wait one minute after shutting off fireplace to allow the control valve to reset before starting again.

## LIGHTING INSTRUCTIONS

### For FBD400TCC-M-HC/MO/NG

Unscrew ignitor cap and install a AAA battery with the + pointing out. Replace cap.

1. **STOP!** Read the safety information on page 17.
2. **Warning:** You must operate this heater with the screen in place. Make sure screen is installed before running heater.
3. Turn control knob clockwise to the OFF position, see Figure 16A.
4. Wait five (5) minutes to clear out any gas. Then smell for gas around heater and near floor. If you smell gas, **STOP!** Follow "B" in the safety information on Warnings plate. If you don't smell gas, go to the next step.
5. Turn control knob counterclockwise to the PILOT position. Keep control knob pressed in for five (5) seconds. **Note:** You may be running this heater for the first time after hooking up to gas supply. If so, the control knob may need to be pressed in for 30 seconds. This will allow air to bleed from the gas system. If control knob does not pop up when released, contact a qualified service person or gas supplier for repairs.
6. With control knob pressed in, push down and release ignitor button. This will light pilot. The pilot is attached to the rear of the front burner. If needed, keep pressing ignitor button until pilot lights. **Note:** If pilot does not stay lit, contact a qualified service person or gas supplier for repairs. Until repairs are made, light pilot with match.
7. Keep control knob pressed in for 30 seconds after lighting pilot. After 30 seconds, release control knob. **Note:** If pilot goes out, repeat steps 3 through 7. This heater has a safety interlock system. Wait one (1) minute before lighting pilot again.
8. **Warning** Make sure while the input gas type is NG, pilot burner NG ignites; while the input type is LP, pilot burner LP ignites. **Note:** If you find anything abnormal in this step, repeat steps 2 through 8.
9. Turn control knob counterclockwise to the desired heating level. The main burner should light. Set control knob to any heat level between HI and LO (5 –1).

### THERMOSTATIC CONTROL OPERATION

**Note:** The thermostat sensing bulb measures the temperature (depending on housing construction, the thermostatic control used on this model differs from standard thermostats. The thermostatic control used on this model differs from standard thermostats. Standard thermostats simply turn the burner on and off. The thermostat used on this heater senses the room temperature. At times the room may exceed the set temperature. If so, the burner will shut off. The burner will cycle back on when room temperature drops below the set temperature. The control knob can be set to any comfort level between HIGH (5) and LOW (1).

## TO TURN OFF GAS TO APPLIANCE

Shut off heater

Turn Control Knob clockwise  to the OFF position. Do not force.

## MANUAL LIGHTING PROCEDURE (Match light)

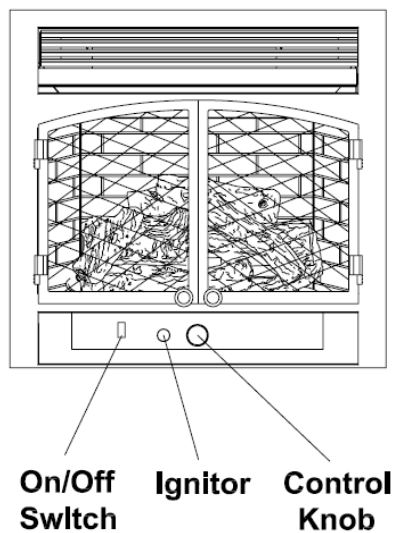

1. Open screen.
2. Follow steps 1 through 5 under Lighting Instructions.
3. With Control Knob in PILOT position, strike match, and hold near pilot. Press in Control Knob; pilot should light.
4. Keep Control Knob pressed in for 30 seconds after lighting pilot. After 30 seconds, release Control Knob.
5. Make sure the heater screen is in place before operating heater.

*Figure 16A - ON/OFF Switch location*



## LIGHTING INSTRUCTIONS

### For FBD400RTCC-M-HC/MO/NG

1. STOP! Read the safety information on the front and back of the warning plate on page 17.
2. Make sure manual shutoff valve is fully open.
3. Unscrew ignitor cap and install an AAA type battery with the anode (+) pointing out. Replace cap.
4. Install two (2) AAA size batteries in the remote transmitter.
5. Be sure the slide switch on the front of the receiver box is in the REMOTE position.
6. Push in the control knob slightly and turn clockwise  to the OFF position.
7. Wait five (5) minutes to clear out any gas. Then smell for gas around the heater and near the floor. If you smell gas, STOP! Follow "B" in the safety information on the rating plate. If you do not smell gas, go to the next step.
8. Push the control knob in slightly and turn counterclockwise  to "PILOT" position and depress for five (5) seconds. **Note:** The first time the heater is operated after connecting the gas supply, the control knob should be depressed for about thirty (30) seconds. This will allow gas to bleed from the gas system.
9. With the control knob pushed in, push down and release the ignitor button. This will light the pilot. If needed, keep pressing the ignitor button until pilot lights.
10. Continue pushing the control knob in for an additional sixty (60) seconds to allow the thermocouple to warm up and to allow air to bleed from the gas system. Release the control knob. **Note:** If the pilot goes out, repeat steps 7, 8, 9 and 10.
11. Rotate the control knob counterclockwise  to the ON position.
12. Press the LEARN BUTTON on the front of the remote receiver box until you hear a beep.
13. Press the ON button on the remote control transmitter to light the burner. (This will also "learn", or program, the transmitter and the receiver).
14. If the transmitter is lost or damaged, the slide switch on the receiver can be used to operate the heater.

## TO TURN OFF GAS TO APPLIANCE

### Shutting off heater

1. Press the OFF button to let pilot stay.
2. Turn gas control knob clockwise  to OFF position to shut off burner.

**Figure 16B - ON/OFF Switch location**

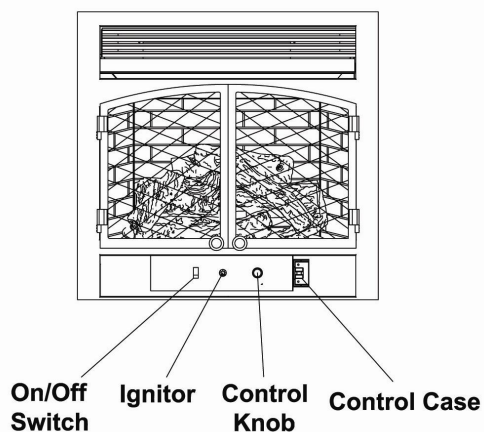

## REMOTE CONTROL FOR FBD400RTCC-M-HC/MO/NG

### MATCHING SECURITY CODES

When matching security codes, be sure slide button on the receiver is in the REMOTE position. To program the remote receiver to LEARN a new security code, press and release the LEARN button on the top of the remote receiver, and then press ON or OFF button on the transmitter. A change in the beeping pattern at the receiver, indicates the transmitter's code has been programmed into the receiver.

### REMOTE CONTROL OPERATION

This appliance must not be used with glass doors in the closed position.

This can lead to pilot outages and severe sooting outside the fireplace.

The transmitter operates on two AAA batteries.

### KEY SETTINGS

**ON** - Operates unit to on position, manually operated solenoid ON.

**OFF** - Operates unit to off position, manually operated solenoid OFF.

**MODE** - Changes unit from manual mode to thermo mode.

**SET** - Sets temperature in thermo mode.

### LCD Liquid Crystal Display

1. **DISPLAY** Indicates CURRENT room temperature.
2. **°F OR °C** Indicates degrees Fahrenheit or Celsius.
3. **FLAME** Indicates burner/valve in operation.
4. **ROOM** Indicates remote is in THERMO operation.
5. **TEMP** Appears during manual operation.
6. **SET** Appears during time the of setting the desired temperature in the thermo operation.

### SETTING °F/°C SCALE

The factory setting for temperature is °F. To change this setting to °C .

First Press the ON key and the OFF key on the transmitter at the same time this will change from °F to °C. Follow this same procedure to change from °C back to °F.

### MANUAL FUNCTION

To operate the system in the manual "MODE" does the following.

#### ON OPERATION

Press the ON key and the appliance flame will come on.

During this time the LCD screen will show ON (Figure 21).

After 3 seconds the LCD screen will default to display room temperature and the word TEMP will show (Figure 22).

(Flame icon will appear on LCD screen in manual on mode).

Figure 17

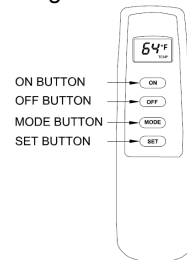

Figure 18

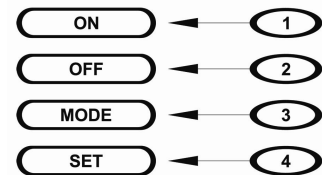

Figure 19

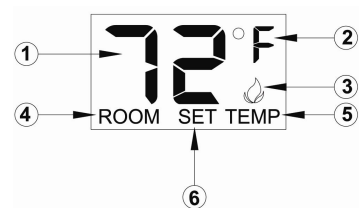

Figure 20



Figure 21



Figure 22



### OFF OPERATION

Press the OFF key and the appliance flame will shut off. During this time the LCD screen will show OF (figure 23). After 3 seconds the LCD screen will default to display room temperature and the wood TEMP will show (figure 24).

Figure 23



Figure 24

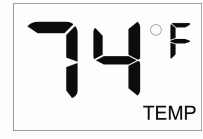

### THERMOSTAT FUNCTION

#### SETTING DESIRED ROOM TEMPERATURE

This remote control system can control the thermostat when the transmitter is in the THERMO mode (The word **ROOM must be displayed on the screen**). To set the THERMO MODE and desired room temperature, Press the MODE key until the LCD screen shows the word ROOM. Then the remote is in the thermostatic mode. Press and hold the SET key until the desired set temperature is reached. (By pressing and holding

Figure 25

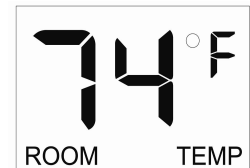
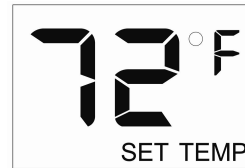

the set key the LCD screen set numbers will increase from 45° to 99° and then restart over at 45°) Next release the SET key. The LCD screen will display the set temperature for 3 seconds and the LCD screen will flash the set temperature for 3 seconds. Then the LCD screen will default to display the room temperature.

#### TO CHANGE THE SET TEMPERATURE

Press and hold the SET key until the desired set temperature is reached. (By pressing and holding the set key the LCD screen set numbers will increase from 45° to 99° then restart over at 45°). Next release the SET key. The LCD screen will display the set temperature for 3 seconds. Then will flash the set temperature for 3 seconds. Then the LCD screen will default to display the room temperature. Press the MODE key to disengage the thermo mode.

Figure 26

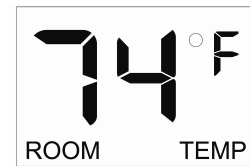

The word ROOM on the LCD screen will not show when the thermo is not in operation.

**NOTE:** The highest SET temperature is 99°F (32 °C) and the lowest temperature is 45°F (6°C).

#### REMOTE CONTROL OPERATION NOTES:

The Thermo Feature on the transmitter operates the appliance whenever the ROOM TEMPERATURE varies a certain number of degrees from the SET TEMPERATURE.

This variation is called the "SWING" or TEMPERATURE DIFFERENTIAL. The normal operating cycle of an appliance may be -4 times per hour depending on how well the room or home is insulated from the cold or drafts. The factory setting for the "swing number" is 2. This represents a temperature variation of +/-2°F (1°C) between SET temperatures and ROOM temperature, which determines when the fireplace will be activated. The transmitter has ON and OFF manual functions that are activated by pressing either button on the face of the transmitter. When a button on the transmitter is pressed the word ON or OF will appear on the LCD screen to show while the signal is being sent. Upon initial use, there may be a delay of three seconds before the remote receiver will respond to the transmitter. This is part of the system's design.

## INSPECTING BURNERS

Check pilot flame pattern and burner flame patterns often.

### PILOT FLAME PATTERN

1. Turn control knob to pilot position
2. Inspect pilot flame and refer to Figure 27 and 28.
  - Figure 27 shows a correct pilot flame pattern.
  - Figure 28 shows an incorrect pilot flame pattern. The incorrect pilot flame is not touching the thermocouple. This will cause the thermocouple to cool. When the thermocouple cools, the heater will shut down.
  - If the pilot flame is incorrect, as shown in Figure 27. Turn heater off (see To Turn off Gas to Appliance, page 20) See troubleshooting, page 25-27.

Figure 27 -Correct Pilot Flame Pattern

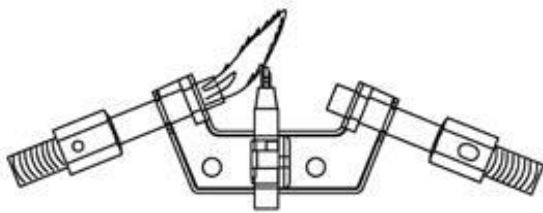
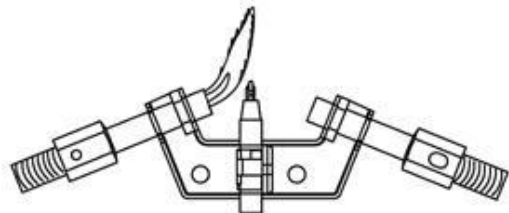

Figure 28 -Incorrect Pilot Flame Pattern



### BURNER FLAME PATTERN

Figure 29 shows a correct burner flame pattern. Figure 30 shows an incorrect burner flame pattern. If pilot flame pattern is incorrect then:

- Turn heater off (see "To Turn off Gas to Appliance," page 20).
- See *Troubleshooting*, pages 25 through 27.

Figure 29- Correct Flame Pattern with Control Knob Set to High Flame (5)

Approx. 3-6" Above Top of logs



Figure 30 - Incorrect Flame Pattern with Control Knob Set to High Flame (5)

More Than 8" Above Top of logs



### BURNER PRIMARY AIR HOLES

Air is drawn into the burner through the holes in the fitting at the entrance to the burner. These holes may become blocked with dust or lint. Periodically inspect these holes for any blockage and clean as necessary. Blocked air holes will create soot.

## CARE AND MAINTENANCE

**⚠ WARNING:** Failure to keep primary air openings of burners clean may result in sooting and property damage.

**⚠ CAUTION:** You must keep control areas, burner, and circulating air passageways of heater clean. Inspect these areas of heater before each use. Have heater inspected yearly by a qualified service person. Heater may need more frequent cleaning due to excessive lint from carpeting, bedding material, pet hair, etc.

The primary air inlet holes allow the proper amount of air to mix with the gas. This provides a clean burning flame. Keep these holes clear of dust, dirt and lint. Clean these air inlet holes prior to each heating season. Blocked air holes will create soot. We recommend that you clean the unit every 500 hours of operation or every three months.

### MAIN BURNER

Periodically inspect all burner flame holes with the heater running. All slotted burner flame holes should be open with yellow flame present. All round burner flame holes should be open with a small blue flame Present. Some burner flame holes may become blocked by debris or rust, with no flame present. If so, turn off heater and let cool, either remove blockage or replace burner. Blocked burner flame holes will create soot.

### CLEANING BURNER INJECTOR HOLDER AND PILOT AIR INLET HOLE

We recommend that you clean the unit every three months or after 2500 hours of operation. We also recommend that you keep the burner tube and pilot assembly clean and free of dust and dirt. To clean these parts we recommend using compressed air no greater than 30 PSI. You can use a vacuum cleaner in the blow position. If using compressed air in a can, please follow the directions on the can. If you don't follow directions on the can, you could damage the pilot assembly.

1. Shut off the unit, including the pilot. Allow the unit to cool for at least thirty minutes.
2. Inspect burner, pilot and primary air inlet holes on injector holder for dust and dirt (see Figure 31).
3. Blow air through the ports/slots and holes in the burner.
4. Check the injector holder located at the end of the burner tube again. Remove any large particles of dust, dirt, lint, or pet hair with a soft cloth or vacuum cleaner nozzle.
5. Blow air into the primary air holes on the injector holder.
6. In case any large clumps of dust have now been pushed into the burner. Repeat steps 3 and 4. Clean the pilot assembly also.

Figure 31 Inject or holder on outlet burner tube

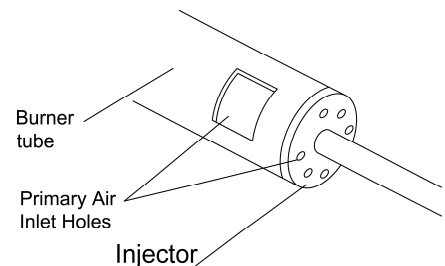

### CLEANING ODS/PILOT

Use a vacuum cleaner, pressurized air, or a small, soft bristled brush to clean.

A yellow tip on the pilot flame indicates dust and dirt in the pilot assembly. There is a small pilot air inlet hole about two inches from where the pilot flame comes out of the pilot assembly (see Figure 32). With the unit off, lightly blow air through the air inlet hole. You may blow through a drinking straw if compressed air is not available.

Figure 32

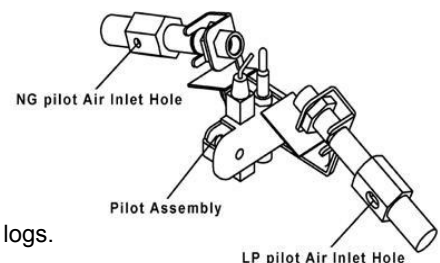

### CABINET

#### Air Passageways

- Use a vacuum cleaner or pressurized air to clean.

#### Exterior

- Use a soft cloth dampened with a mild soap and water mixture.
- Wipe the cabinet to remove dust.

### LOGS

- If you remove logs for cleaning, refer to Installing Logs to properly replace logs.
- Replace log(s) if broken or chipped (dime-size or larger).

### BLOWER (OPTIONAL ACCESSORY)

Refer to model QEB100 manual.



## TROUBLESHOOTING



**WARNING:** If you smell gas

- Shut off gas supply.
- Do not try to light any appliance.
- Do not touch any electrical switch; do not use any phone in your building.
- Immediately call your gas supplier from a neighbor's phone. Follow the gas supplier's instructions.
- If you cannot reach your gas supplier, call the fire department.

**IMPORTANT:** Operating heater where impurities in air exist may create odors. Cleaning supplies, paint, paint remover, cigarette smoke, cements and glues, new carpet or textiles, etc., create fumes. These fumes may mix with combustion air and create odors.



**WARNING:** Make sure that power is turned off before proceeding.



**WARNING:** Turn off and let cool before servicing. Only a qualified service person should service and repair heater.



**CAUTION:** Never use a wire, needle, or similar object to clean ODS/pilot. This can damage ODS/pilot unit.

### OBSERVED PROBLEM

### PROBABLE CAUSE

### REMEDY

<p>When ignitor button is pressed in, there is no spark at ODS/pilot</p>	<ol style="list-style-type: none"> <li>1. Ignitor electrode is positioned wrong.</li> <li>2. Ignitor electrode is broken.</li> <li>3. Ignitor electrode is not connected to ignitor cable.</li> <li>4. Ignitor cable is pinched or wet.</li> <li>5. Damaged ignitor cable.</li> <li>6. Bad piezo ignitor.</li> <li>7. Low battery.</li> </ol>	<ol style="list-style-type: none"> <li>1. Replace electrode.</li> <li>2. Replace electrode.</li> <li>3. Reconnect ignitor cable.</li> <li>4. Free ignitor cable if pinched by any metal or tubing. Keep ignitor cable dry.</li> <li>5. Replace ignitor cable.</li> <li>6. Replace piezo ignitor.</li> <li>7. Replace battery.</li> </ol>
<p>When ignitor button is pressed in, there is a spark at ODS/pilot but no pilot flame present.</p>	<ol style="list-style-type: none"> <li>1. Gas supply is turned off or equipment shutoff valve is closed.</li> <li>2. Control knob not fully pressed in while pressing ignitor button.</li> <li>3. Air in gas lines (new installation or recent gas interruption).</li> <li>4. ODS/pilot is clogged.</li> <li>5. Incorrect inlet gas pressure or inlet regulator is damaged.</li> <li>6. Depleted gas supply.</li> </ol>	<ol style="list-style-type: none"> <li>1. Turn on gas supply or open equipment shutoff valve.</li> <li>2. Fully press in control knob while pressing ignitor button.</li> <li>3. Continue holding down control knob for 30 seconds to remove air. Repeat igniting operation until air is removed.</li> <li>4. Clean ODS/pilot (see <i>Care and Maintenance</i> Page 24) or replace ODS/pilot assembly.</li> <li>5. Check inlet gas pressure or replace inlet gas regulator.</li> <li>6. Contact local propane/LP Gas Company.</li> </ol>

<b>OBSERVED PROBLEM</b>	<b>PROBABLE CAUSE</b>	<b>REMEDY</b>
<p>ODS/pilot lights but flame goes out when control knob is released.</p>	<ol style="list-style-type: none"> <li>1. Control knob is not fully pressed in.</li> <li>2. Control knob is not pressed in long enough.</li> <li>3. Equipment shutoff valve is not fully open.</li> <li>4. Thermocouple connection is loose.</li> <li>5. Thermocouple damaged</li> <li>6. Control valve damaged.</li> </ol>	<ol style="list-style-type: none"> <li>1. Press in control knob fully.</li> <li>2. After ODS/pilot lights, keep control knob pressed in 30 seconds.</li> <li>3. Fully open equipment shutoff valve.</li> <li>4. Hands tighten until snug, and then tighten ¼ turn more.</li> <li>5. Replace thermocouple.</li> <li>6. Contact Customer Service.</li> </ol>
<p>Burner(s) does not light after ODS/pilot is lit.</p>	<ol style="list-style-type: none"> <li>1. Burner orifice is clogged.</li> <li>2. Burner orifice diameter is too small.</li> <li>3. Inlet gas pressure is too low.</li> </ol>	<ol style="list-style-type: none"> <li>1. Burner orifice (see <i>Care and maintenance</i> Page 24) or replace burner orifice.</li> <li>2. Contact Customer Service.</li> <li>3. Contact your gas supplier.</li> </ol>
<p>Delayed ignition of burner(s).</p>	<ol style="list-style-type: none"> <li>1. Manifold pressure is too low.</li> <li>2. Burner orifice is clogged.</li> </ol>	<ol style="list-style-type: none"> <li>1. Contact your gas supplier.</li> <li>2. Clean burner (see <i>Care and maintenance</i> Page 24) or Contact Customer Service.</li> </ol>
<p>Burner backfiring during combustion.</p>	<ol style="list-style-type: none"> <li>1. Burner orifice is clogged or damaged.</li> <li>2. Burner is damaged.</li> <li>3. Gas regulator is damaged.</li> </ol>	<ol style="list-style-type: none"> <li>1. Clean burner orifice (see <i>Care and maintenance</i> Page 24) replace.</li> <li>2. Contact Dealer or Customer Service.</li> <li>3. Replace gas regulator.</li> </ol>
<p>High yellow flame during burner combustion.</p>	<ol style="list-style-type: none"> <li>1. Not enough air.</li> <li>2. Gas regulator is defective.</li> <li>3. Inlet gas pressure is too low.</li> </ol>	<ol style="list-style-type: none"> <li>1. Check burner for dirt and debris. If found, clean burner (see <i>Care and Maintenance</i> Page 24).</li> <li>2. Replace gas regulator.</li> <li>3. Contact your gas supplier.</li> </ol>
<p>Gas odor during combustion.</p>	<ol style="list-style-type: none"> <li>1. Foreign matter between control valve and burner.</li> <li>2. Gas leak. (See Warning Statement at top of page 25).</li> </ol>	<ol style="list-style-type: none"> <li>1. Take apart gas tubing and remove foreign matter.</li> <li>2. Locate and correct all leaks (see “Checking Gas Connections”, page 14).</li> </ol>

<b>OBSERVED PROBLEM</b>	<b>PROBABLE CAUSE</b>	<b>REMEDY</b>
Slight smoke or odor during initial operation	1. Residues from manufacturing process.	1. Problem will stop after a few hours of operation.
Heater produces a whistling noise when burner is lit.	1. Turning control knob to high (5) position when burner is cold. 2. Air in gas line. 3. Air passageways on heater are blocked. 4. Dirty or partially clogged burner orifice.	1. Turn control knob to low (1) position and let warm up for a minute. 2. Operate burner until air is removed from line. Have gas line checked by local propane/LP Gas Company. 3. Observe minimum installation clearances (Figure 4, page 10) 4. Clean burner (see <i>Care and Maintenance</i> Page 24) or replace burner orifice.
Heater produces a clicking/ticking noise just after burner is lit or shut off.	1. Metal is expanding while heating or contracting while cooling.	1. This is common with most heaters. If noise is excessive, contact qualified service technician.
White powder residue forming within burner box or on adjacent walls or furniture	1. When heated, the vapors from furniture polish, wax, carpet cleaners etc., turn into white powder residue.	1. Turn heater off when using furniture polish, wax, and carpet cleaner or similar products.
Heater produces unwanted odors.	1. Heater is burning vapors from paint, hair spray, glues, etc. (See IMPORTANT statement page 26). 2. Gas leak. See Warning Statement at the top of page 26. 3. Low fuel supply.	1. Ventilate room. Stop using odor causing products while heater is running. 2. Locate and correct all leaks (see <i>Checking Gas Connections</i> , page 14). 3. Refill supply tank (Propane/ LP models).
Heater shuts off in use (ODS operates).	1. Not enough fresh air is available. 2. Low line pressure. 3. ODS/pilot is partially clogged.	1. Open window and/or door for ventilation. 2. Contact local gas supplier. 3. Clean ODS/pilot (see <i>Care and Maintenance</i> , page 24).
Gas odor exists even when control knob is in OFF position.	1. Gas leak. See Warning Statement at top of page 26. 2. Control valve is defective.	1. Locate and correct all leaks (see "Checking Gas Connections", page 14). 2. Contact customer service.
Moisture/condensation noticed on windows.	1. Not enough combustion/ventilation air.	1. Refer to "Air for Combustion and Ventilation" requirements page 7.

## **REPLACEMENT PARTS**

**NOTE:** Use only original replacement parts. This will protect your warranty coverage for parts replaced under warranty.

### **PARTS UNDER WARRANTY**

Contact authorized dealers of this product. If they can't supply original replacement parts, call Customer Service toll free at (1-877-886-5989) for referral information.

When calling Customer Service or your dealer, have ready:

- Your name
- Your address
- Model and serial number of your heater
- How heater was malfunctioning
- Type of gas used (Propane/LP or Natural gas/NG)
- Purchase date
- Usually, we will ask you to return the defective part to the factory

### **PARTS NOT UNDER WARRANTY**

Contact authorized dealers of this product. If they can't supply original replacement part(s) call Customer Service toll free at (1-877-886-5989) for referral information.

When calling Customer Service have ready:

- Model number of your heater
- The replacement part number

## PARTS LIST (FBD400TCC-M-HC/MO/NG & FBD400RTCC-M-HC/MO/NG)

This list contains replaceable parts used in your heater. When ordering parts, follow the instructions listed under Replacement Parts on page 28 of this manual.

Key No.	Description	Part Number	QTY	
			FBD400TCC-M-HC/MO/NG	FBD400RTCC-M-HC/MO/NG
1	Hood	FHL008-02D	1	1
2	Louver	FBB102	1	1
3	Door Assembly	FBB104B	1	1
4	ODS	NDD0308 - 400	1	1
5	Regulator	RV83FI-4/9	2	2
6	Ignitor	AL092-01 & PIMSC1-01	1	1
7	HL041-01	Log 1	1	1
8	HL042-01	Log 2	1	1
9	HL043-01	Log 3	1	1
10	HL044-01	Log 4	1	1
11	HL045-01	Log 5	1	1
12	HL045-02	Log 6	1	1
13	Gas Selector Valve Assembly	YDF06-FBD32RT	1	1
14	Selector Valve Knob	MDL304B	1	1
15	Receiver Box	UN3		1
16	Remote Control	CON 1001TH		1

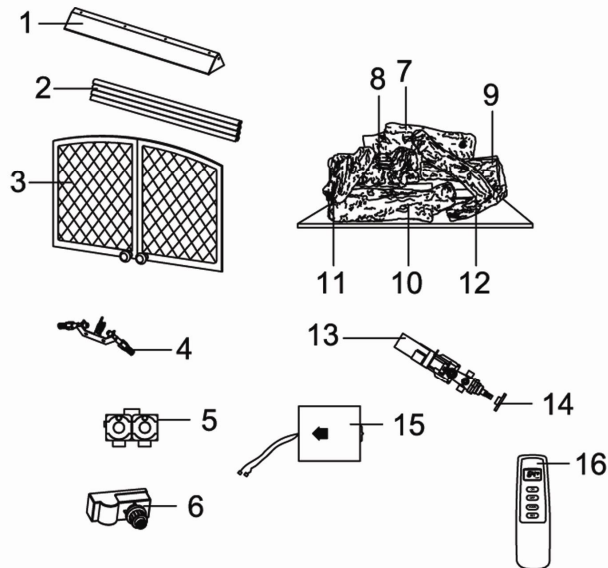

Printed in China