

PSI Audio R&B 8A Router and Bass-management

User Manual & Technical Datasheet

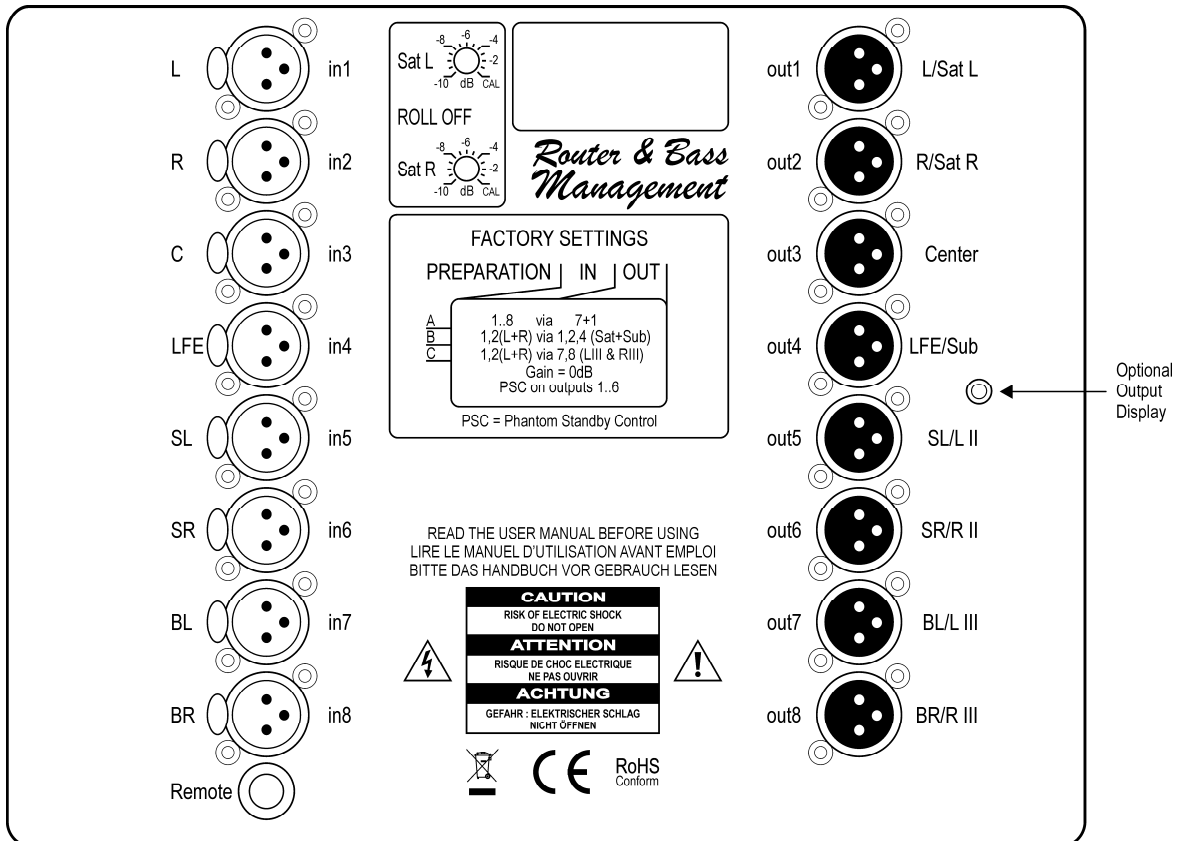

Functions

- Easy switching between 3 Monitoring systems
- Use of one multichannel speakers system in multichannel, satellite+sub or stereo modes
- Subwoofer usable as bass extension or LFE
- Standby/Mute and switching modes controlled by an standard double footswitch
- Standby control for the unused PSI Audio speakers

Key features

- Full analog transparent system without internal channels mixing
- Integrated into the subwoofer PSI Audio A225-M as an option
- Optional display providing standby and preparation modes
- True balanced outputs adapted for balanced or unbalanced inputs
- Internal input gains adjustments
- Compatible with any monitors brand.

TABLE OF CONTENTS

1	INTRODUCTION.....	3
2	SAFETY INSTRUCTION.....	3
2.1	WARNINGS	3
2.2	SERVICE.....	4
3	GENERAL OVERVIEW	4
3.1	BEFORE YOU START	4
4	QUICK START.....	5
5	OPERATION	6
5.1	AUDIO SIGNAL INPUT CONNECTOR	6
5.2	FOOTSWITCH	6
5.3	ROLL-OFF	6
5.4	GLOBAL GAIN	6
6	SETTINGS.....	7
6.1	FACTORY SETTINGS	7
6.2	PSC (PHANTOM STANDBY CONTROL).....	7
6.3	HI-LFE UPMIX	8
6.4	PREPARATION C USED	8
	THE C PREPARATION IS ACTIVATED BY THE SECOND (RIGHT) FOOTSWITCH. ACTIVATING THE FOOTSWITCH ENABLES YOU TO SWITCH SUCCESSIVELY BETWEEN A, B AND C PREPARATION, THEN BACK TO A, B... AND SO FORTH.	8
	FOR AB COMPARISONS, THE SWITCH 8 "PREP. C USED" WILL BE OFF.	8
6.5	PREPARATION A : 1...8 VIA 1...8 (SYSTEM 7.1).....	8
6.6	PREPARATION B : 1,2 (L+R) VIA 1,2, 4 (SAT+SUB).....	8
6.7	PREPARATION C : 1,2 (L+R) VIA 7,8 (LIII AND RIII).....	8
7	POSSIBLE ADAPTATIONS BY A QUALIFIED TECHNICIAN	8
7.1	INTRODUCTION	8
7.2	CONFIGURATIONS	8
7.3	USUAL CONFIGURATIONS	9
8	C.E. & ROHS CONFORMITIES.....	10
9	WARRANTY.....	10
10	BLOCK DIAGRAM	11
11	TECHNICAL DATA	11

1 Introduction

Thank you very much, and congratulations on your decision to purchase a professional Router and Bass-management (R&B) system from PSI Audio. The R&B, here after called "device", can be either integrated into a subwoofer PSI Audio sub A225-M or available as a stand-alone product. The following instructions can be applied for both products.

Following carefully the instructions in this manual will ensure that your device will give you many years of reliable and trouble free operation.

For the latest information, help or advice, please contact your local PSI Audio representative or PSI Audio directly.

Relec S.A.
Rue des Petits Champs 11 a+b
CH-1400 YVERDON (Switzerland)
Tel : +41 (0)24 426 0420
Tel : +41 (0)24 426 0451
E info@psiaudio.com
W www.psiaudio.com

2 Safety Instruction



This symbol alerts the user to the presence of electrical power within the product that may be of sufficient magnitude to constitute a risk of electric shock.



This symbol alerts the user to important operating and maintenance (servicing) instructions or warnings.

2.1 Warnings

- Please read and follow the instructions of this manual carefully before using your system.
- Please do not open the device - risk of electric shock inside.
- Make sure not to expose the device to any form of liquids. For cleaning purposes use only a dry cloth. In order to prevent spills, do not place any containers containing liquid on the device. Do not use the device close to water as this may create a shock hazard.
- Check your AC voltage and make sure that the voltage setting and fuse on the rear of the chassis are set correctly.
- Do not operate the device in a confined environment (i.e. in a flight case) The rear panel of the speaker must not be covered and permit appropriate circulation and ventilation of air for cooling purposes. Make sure all ventilation openings are free of any obstacles.
- Do not operate or install this device near any kind of heat source.

2.2 Service



The device contains no user-serviceable parts. All service must be performed by qualified personnel. The primary fuse must be replaced by exactly the same type and rating. The unit must not be opened by the user – risk of a severe electric shock. The device can be configured for many applications. Factory settings are related to most common uses of the device.

Servicing is required when:

- changing the factory settings
- the device has been damaged in some way, such as when the power-supply cord or plug is damaged.
- the device has suffered from exposure to rain or moisture
- liquid has been spilled into the device.
- objects have been dropped into the device
- the device does not work correctly.

Spare part supply:

- For ordering, please contact your authorized dealer, mentioning your device/loudspeaker model and serial number (see point 3.3.).

3 General Overview

3.1 Before you start

Special care have been taken in the packaging of your PSI Audio equipment. Before you start to install it, please check that the following parts are included:

- If the R&B device is originally mounted into a subwoofer, you shall also get in the package:

- PSI AUDIO R&B User Manual (this manual)

- If the R&B device is delivered to be integrated into a subwoofer, you shall also get in the package:

- PSI AUDIO R&B User Manual (this manual)
- 3 separate power supply cables to connect the R&B PCB to the subwoofer.
- 1 sticker A6 with the Factory settings that you can stick inside the amplifier chamber of your subwoofer as a reminder.

4 Quick Start

We recommend that you spend some time to set up your monitoring speaker system with your Router and Bass-management system.

Setting it up naturally takes a certain amount of time. However, in case you need to get started quickly, please follow the quick set up guide. The rest of this manual will assist you in setting up your loudspeaker system and calibrate it according to your listening environment.

- Check that the voltage value on the AC power selector is set correctly (according to your local AC power supply). If this is not the case, it will be necessary to adjust main power with the following procedure. Carefully squeeze the two latches on either side of the fuse plug and pull the fuse holder out of its socket. Now replace the fuse for the different voltage setting with the correct value fuse according to the required voltage. The correct value of the fuse is printed next to the On-Off switch of your device. Pull out the grey plastic cap which holds the fuse and turn it 180° so it shows the correct voltage setting through the outer window when placed back in its position. Now you can carefully push the complete fuse holder back in to its place above the mains connector.
- Connect the audio source(s) (line signal) from your mixer, preamplifier or other equipment to the XLR connector input.
- Control the compatibility of the PSI Audio R&B with your monitors. If you use monitors of the PSI Audio M series, a standby phantom voltage (PSC – phantom standby control) is provided by the R&B. This voltage is immediately stopped when you switch on the remote dual footswitch. If some monitors do not feature the PSC technology, your router can be configured accordingly by a qualified technician without any additional device. Your router is therefore compatible with the vast majority of audio monitors of the market.
- Verify that the Roll-Off potentiometers of the satellite monitor and of the Router are in a factory settings configuration. The Roll-off of the satellite monitor is turned fully clockwise in order to provide a flat frequency response to start with. The Roll-off of the R&B device is turned fully counter-clockwise.
- Connect the mains cable with power whilst paying attention to the warnings mentioned under the chapter safety instructions.
- Verify that no audio signal is been sent to the device and turn the power switch to ON. The green led on the front panel will now illuminate.
- If you work with the Satellite + Subwoofer listening mode, the roll-off must be adjusted to get the right tonal balance with or without the subwoofer. This also implies a right placement of the subwoofer as well as a calibration of the level of the subwoofer.

Please refer to the User Manual of the subwoofer “chapter 6. Installation p. 7 to 11” for more detail about the subwoofer calibration.

When you switch on the device with the factory settings, the R&B is in A preparation mode.

You can mute your system when you press on the first (left) button of your remote footswitch.

5 Operation

5.1 Audio Signal Input Connector

The female XLR connector on the rear panel provides a balanced analog input with the following wiring conventions :

- 1 = Chassis (Ground)
- 2 = + Hot
- 3 = - Cold

When using the device with unbalanced sources, the following wiring conventions may be used

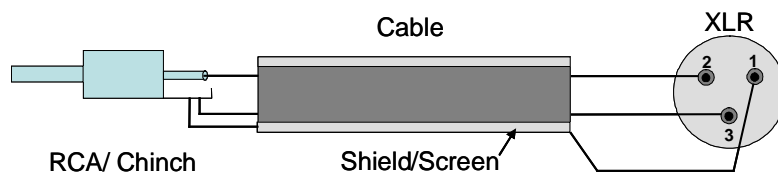

5.2 Footswitch

The first button (left) of the remote dual footswitch enables to command the standby function of the R&B and of the Monitors according to the configuration of the factory settings. The A, B and C preparations determine how to route the inputs to the outputs of the R&B and the bass-management. The configuration determines if each monitor is compatible with the Phantom Standby Control (PSC) technology. It also determines the function of the Hi-LFE upmix, as well as the C preparation.

5.3 Roll-off

The roll-off potentiometer enables to decrease the low frequencies of the monitors for a Satellite+Subwoofer preparation. The roll-off is not active for other types of preparations.

The calibration of the sub level should be done by comparing a stereo preparation with a satellite + subwoofer preparation. The signal used for the calibration should contain low frequencies (about 70Hz – lows of a cello). Adjust the level of the subwoofer, then the Roll off of the R&B so that you get the same tonal balance on both preparation (with and without the subwoofer). This calibration is also valid for the use of the subwoofer as an LFE in a surround system.

5.4 Global gain

The global gain is usually set at 0dB (LFE +10dB). In case of weaker signals (non-professional systems), the input gains can be recalibrated by a qualified technician.

6 Settings

CONFIGURATION:

ON							
<input checked="" type="checkbox"/>	<input checked="" type="checkbox"/>	<input checked="" type="checkbox"/>	<input checked="" type="checkbox"/>	<input checked="" type="checkbox"/>	<input checked="" type="checkbox"/>	<input checked="" type="checkbox"/>	<input checked="" type="checkbox"/>
1	2	3	4	5	6	7	8

PREPARATIONS:

ON							
<input checked="" type="checkbox"/>	<input checked="" type="checkbox"/>	<input checked="" type="checkbox"/>	<input checked="" type="checkbox"/>	<input checked="" type="checkbox"/>	<input checked="" type="checkbox"/>	<input checked="" type="checkbox"/>	<input checked="" type="checkbox"/>
1	2	3	4	5	6	7	8

CONFIGURATION:

ON							
<input checked="" type="checkbox"/>	<input checked="" type="checkbox"/>	<input checked="" type="checkbox"/>	<input checked="" type="checkbox"/>	<input checked="" type="checkbox"/>	<input checked="" type="checkbox"/>	<input checked="" type="checkbox"/>	<input checked="" type="checkbox"/>
1	2	3	4	5	6	7	8

PREPARATIONS:

ON							
<input checked="" type="checkbox"/>	<input checked="" type="checkbox"/>	<input checked="" type="checkbox"/>	<input checked="" type="checkbox"/>	<input checked="" type="checkbox"/>	<input checked="" type="checkbox"/>	<input checked="" type="checkbox"/>	<input checked="" type="checkbox"/>
1	2	3	4	5	6	7	8

CONFIGURATION:

ON							
<input checked="" type="checkbox"/>	<input checked="" type="checkbox"/>	<input checked="" type="checkbox"/>	<input checked="" type="checkbox"/>	<input checked="" type="checkbox"/>	<input checked="" type="checkbox"/>	<input checked="" type="checkbox"/>	<input checked="" type="checkbox"/>
1	2	3	4	5	6	7	8

in factory settings positions

1 ON = PSC for output 1,2
2 ON = PSC for output 3
3 ON = PSC for output 4
4 ON = PSC for output 5,6
5 ON = PSC for output 7,8
6 ON = PSC for unused
7 ON = Hi-LFE upmix
8 ON = Prep. "C" used

1 ON = used output 1,2
2 ON = used output 3
3 ON = used output 4
4 ON = used output 5,6
5 ON = used output 7,8
6 ON = +10dB LFE
7 ON = mode SAT+SUB
8 ON = 1,2 via 5,6 & 7,8

6.1 Factory settings

The following settings can all be adapted by a qualified technician (see chapter 7).

The factory settings set the global gain at 0dB. The roll-off are set at -10dB.

Here is the procedure to integrate the R&B board into the subwoofer:

- 1) Lay the subwoofer on the side and make sure the power cable is not connected.
- 2) Open the 3 screws of the left side of the subwoofer amplifier board and open the back panel like a door.
- 3) Remove the blank cover at the back of your subwoofer (this blank panel made to integrate the R&B board only exists from the PSI Audio subwoofer A225-M V5. Please contact us at info@psiaudio.com if you own an older version to get a quote for an upgrade).
- 4) Stick the A6 sticker labelled "Factory Settings" inside the amplifier chamber of your subwoofer as a help and reminder.
- 5) Install the R&B board and screw the right side of the board
- 6) Before you screw the panels on the subwoofer, interconnect the R&B board to the subwoofer with the 3 power supply cables. There are three slots, make sure to connect the power supply cable with the black connector (ground) in the centre slot. The other two (+V2 and -V2) shall be indifferently placed of both sides of it.
- 7) You can now configure your R&B board according to your needs (see chapter 7 here below)
- 8) Screw your R&B and your subwoofer board. The installation of the R&B board is now done, you are now ready to interconnect your source to the device and then from your device to your speakers.

6.2 PSC (Phantom Standby Control)

The PSC is activated for outputs 1 to 6 and allows to put the unused channel in standby mode with PSC equipped monitors.

PSC are not activated for outputs 7 and 8, in order to switch on a Monitor system that does not feature the PSC technology.

6.3 Hi-LFE Upmix

If by accident, the LFE signal contains frequencies above 120Hz, those frequencies would be reduced by 6dB and reinjected in the outputs 1 and 2 to be easily detected.

6.4 Preparation C used

The C preparation is activated by the second (right) footswitch. Activating the footswitch enables you to switch successively between A, B and C preparation, then back to A, B... and so forth.

For AB comparisons, the Switch 8 "prep. C used" will be OFF.

6.5 Preparation A : 1...8 via 1...8 (system 7.1)

This listening mode is adapted for multichannel monitoring 5.1 and 7.1. The inputs 1, 2, 3 and 5, 6, 7, 8 via 1, 2, 3 and 5, 6, 7, 8 without modifications. The input 4 (LFE) is amplified by 10dB via output 4. At the same time, it is reduced by 6dB with a high-pass at 120Hz and remixed via output 1 and 2.

6.6 Preparation B : 1,2 (L+R) via 1,2, 4 (sat+sub)

This system is particularly efficient when space is an issue and high SPL are required for recording.

Low frequencies of inputs 1 and 2 are reduced by the "Roll off", the signal is directed respectively via output 1 and 2. The sum of the channel 1 and 2 are sent via output 4, the PSI sub A225 makes the complementary response from 24Hz.

6.7 Preparation C : 1,2 (L+R) via 7,8 (LIII and RIII)

This system enables to compare a third system. The inputs 1 and 2 are directed respectively via output 7 and 8 without changes.

7 Possible adaptations by a qualified technician

7.1 Introduction

For all changes of configuration, such as configuration changes, the power cable must be disconnected.

Unscrew the two screws on the left side of the R&B seen from the serigraphy back panel. The back panel opens like a door and should not be opened more than the 90° right angle.

At the centre on the low part of the PCB are 4 groups of 8 switches

- The superior group manages the configurations
- The second group manages the preparation A
- The third group manages the preparation B
- The fourth group manages the preparation C

7.2 Configurations

Switch 1 = ON

A voltage of 5V is active at the outputs 1 and 2 for mute for the monitors that feature the PSC technology. If the monitors do not feature PSC technology, the Switch 1 = OFF

Switch 2 = ON

Same for output 3

Switch 3 = ON

Same for output 4

Switch 4 = ON

Same for outputs 5 and 6

Switch 5 = ON

Same for outputs 7 and 8

Switch 6 = ON

The monitors unused will automatically turn in standby mode (red LED).

If the monitors must always to be always be on (green LED) the switch 6 = OFF

Switch 7 = ON

On Multichannel recordings, high frequencies on the input 4 (LFE) must absolutely be avoided. For controlling, in order to be sure that those frequencies could be heard, all the frequencies above 120Hz are reduced by 6dB and remixed in the outputs 1 and 2. If all channels must be independent, the switch 7 = OFF.

Switch 8 = ON

The R&B enables to switch successively between preparations A, B and C. To restrict the comparisons to AB only, the switch 8 = OFF

7.3 Usual configurations

MODE MULTI 8 DISCRETS

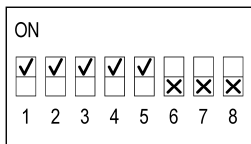

+ configuration SW 7 "OFF"

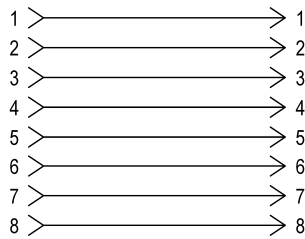

MODE STEREO I

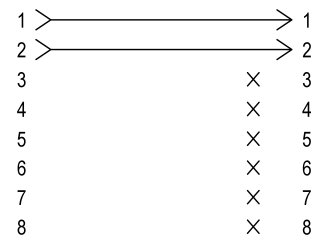
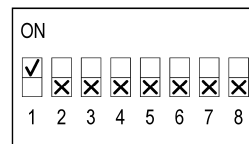

MODE MULTI 7.1 (Factory setting A)

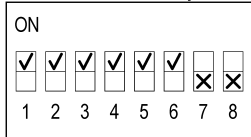

+ configuration SW 7 "ON"

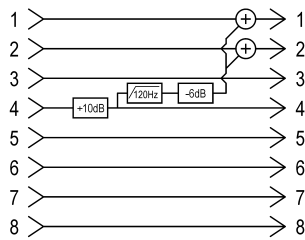

MODE STEREO II

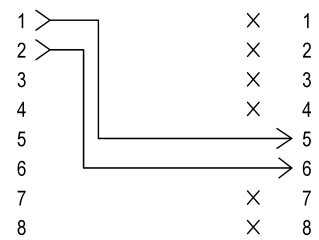
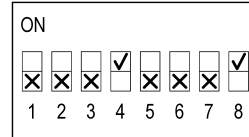

MODE SAT.+ SUB (Factory setting B)

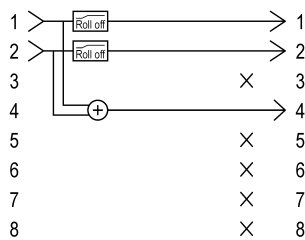
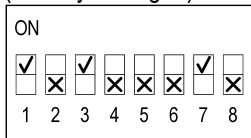

MODE STEREO III (Factory setting C)

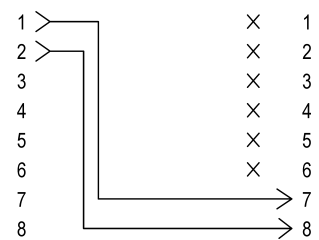
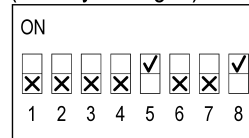

Important notice : when the R&B is integrated into the PSI Audio A225-M, the XLR output 4 of the R&B board must be connected to the XLR input of the A225-M with a short balanced cable.

8 C.E. & RoHS Conformities

Beyond the tests of all components, the PSI Audio products have been tested and calibrated according to the highest quality standards.

The PSI Audio products have been tested according to EU directives and amendments:

Low voltage directive (LVD), 2006/95/EC
Electromagnetic compatibility directive (EMC), 2004/108/EC

The relevant technical standards are:

EN 60065: 1998 Audio, video and similar apparatus – Safety requirements (Class 1)

EN 55103-1/E1: 1996 Product Standard – Emission
Audio, Video and audio-visual apparatus for professional use

EN 55103-2/E1: 1996 Product Standard – Immunity
Audio, Video and audio-visual apparatus for professional use



This product is manufactured according to the European directive 2002/95/EC

9 Warranty

Our products are guaranteed during 2 years against any manufacturing defect. Fair or wrong wear and tear are not covered by the warranty. We kindly remind the user that unauthorised servicing can void the warranty. In order to provide a quality service, we ask the user to always join the warranty card for each servicing.

For servicing, the expenses and the risks of transport are the responsibility of the customer.
For any other provision, the Swiss Code of Obligations, Articles 197 to 210 will apply.
For any legal action, reference will apply to the Court of Yverdon (Switzerland) only.

10 Block Diagram

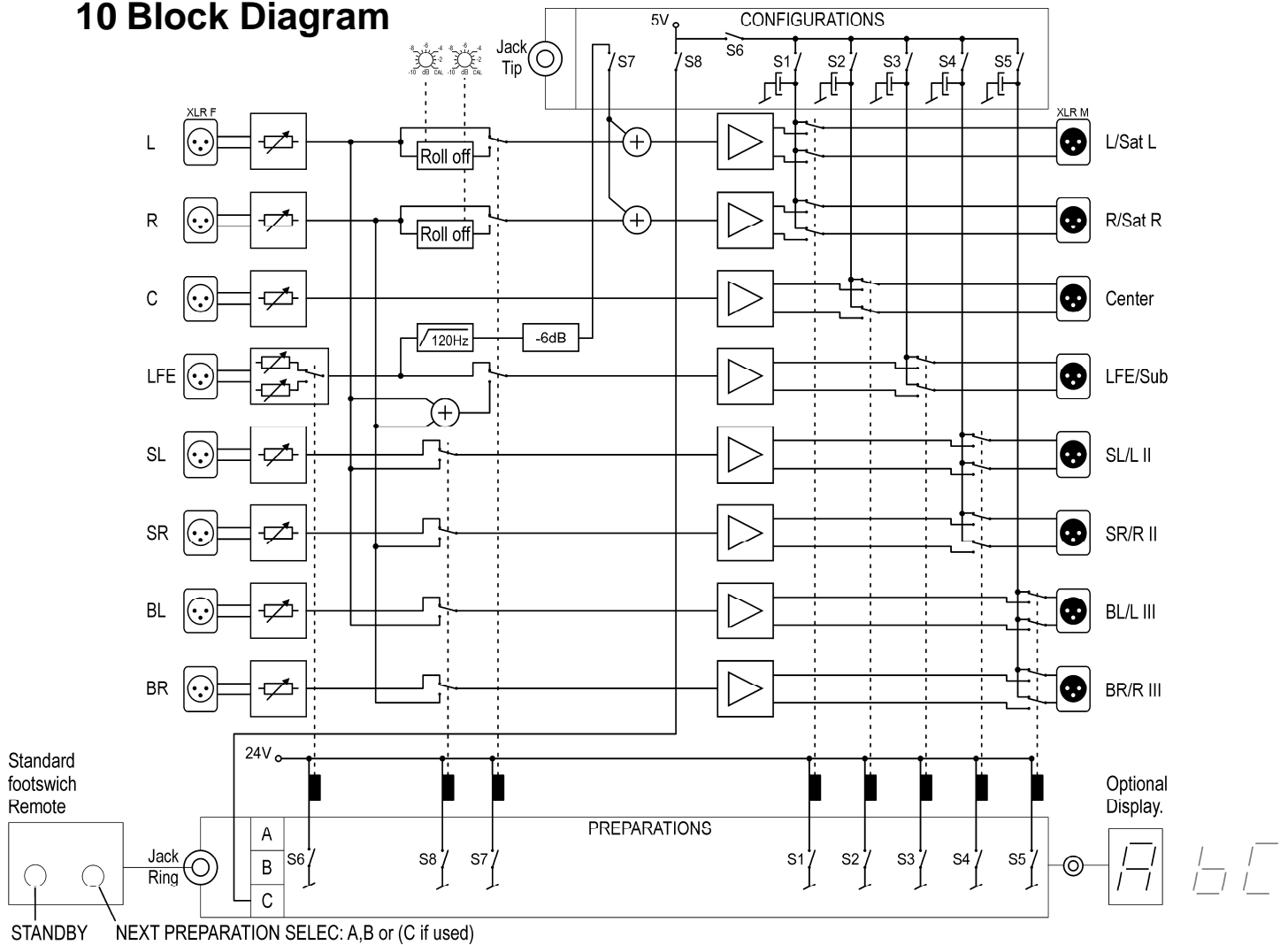

11 Technical Data

Input Impedance:

8 x Sym, 10kOhms

Response:

± 0.1dB (20Hz-20kHz)

± 1 dB (5Hz-100kHz)

Signal to Noise Ratio:

-96 dBu pond A

CMRR:

> -55 dB (20Hz-20kHz)

Dynamic range:

> 118 dBA

Interchannel isolation:

> 90 dBA

Gain:

Inputs 1..3,5..8 : 0dB intern. adj. -2..+12dB

Inputs 4 : 0/+10dB intern. adj. -2..+12dB

Max Output Level:

28Vpp <0.001% THD

if PSC used: 5V DC Phantom in standby

Input Overload:

24 Vpp

Distortion THD:

<0.001%

System:

8 IN => 8 OUT

Connectors:

IN/OUT XLR Balanced

Remote Jack 6.35 3p

Signal input:

XLR : 1=GND, 2=(+), 3=(-)

JACK : Ring : GND=Power ON, OPEN=Standby

Tip : GND,OPEN change=Next Preparation

Dimensions W x H x D mm:

280 x 220 x 60

Gross / Net Weight:

0.95 kg

Voltage:

115/230V (50-60Hz)

Consumption Standby-Quiescent-Max:

1.4 - 14 - 20 W

Mean / Max Humidity:

< 75% / < 90%

External Temperature:

5 - 40°C

Remote:

Standard dual foot switch (ex: FS-202 Stageline)

