

# MITSUBISHI

---

# Type A1SJHCPU

---

## Mitsubishi Programmable Controller User's Manual (Hardware)

Thank you for purchasing the Mitsubishi program controller  
MELSEC-A series.

**Prior to use, please read both this and relevant manuals  
thoroughly to fully understand the product.**



MODEL	A1SJCPU(H/W)-U-E
MODEL CODE	13JE60
IB(NA)-66469-P(1406)MEE	



## ● SAFETY PRECAUTIONS ●

(Read these precautions before using this product.)

Before using this product, please read this manual and the relevant manuals carefully and pay full attention to safety to handle the product correctly.

In this manual, the safety precautions are classified into two levels:  
"⚠ WARNING" and "⚠ CAUTION".

### **WARNING**

Indicates that incorrect handling may cause hazardous conditions, resulting in death or severe injury.

### **CAUTION**

Indicates that incorrect handling may cause hazardous conditions, resulting in minor or moderate injury or property damage.

Under some circumstances, failure to observe the precautions given under "⚠ CAUTION" may lead to serious consequences.

Observe the precautions of both levels because they are important for personal and system safety.

Make sure that the end users read this manual and then keep the manual in a safe place for future reference.

## [DESIGN PRECAUTIONS]

### **WARNING**

- Create a safety circuit outside the programmable controller to ensure the whole system will operate safely even if an external power failure or a programmable controller failure occurs.  
Otherwise, incorrect output or malfunction may cause an accident.
  - (1) For an emergency stop circuit, protection circuit and interlock circuit that is designed for incompatible actions such as forward/reverse rotation or for damage prevention such as the upper/lower limit setting in positioning, any of them must be created outside the programmable controller.  
Install the emergency stop switch outside the control panel so that workers can operate it easily.

## [DESIGN PRECAUTIONS]

### WARNING

- (2) When the programmable controller detects the following error conditions, it stops the operation and turn off all the outputs.
- The overcurrent protection device or overvoltage protection device of the power supply module is activated.
  - The programmable controller CPU detects an error such as a watchdog timer error by the self-diagnostics function.

In the case of an error of a part such as an I/O control part that cannot be detected by the programmable controller CPU, all the outputs may turn on. In order to make all machines operate safely in such a case, set up a fail-safe circuit or a specific mechanism outside the programmable controller.

Refer to "LOADING AND INSTALLATION" in this manual for example fail safe circuits.

- (3) Depending on the failure of the output module's relay or transistor, the output status may remain ON or OFF incorrectly. For output signals that may lead to a serious accident, create an external monitoring circuit.
- If load current more than the rating or overcurrent due to a short circuit in the load has flowed in the output module for a long time, it may cause a fire and smoke. Provide an external safety device such as a fuse.
  - Design a circuit so that the external power will be supplied after power-up of the programmable controller.  
Activating the external power supply prior to the programmable controller may result in an accident due to incorrect output or malfunction.
  - For the operation status of each station at a communication error in data link, refer to the respective data link manual.  
The communication error may result in an accident due to incorrect output or malfunction.

## [DESIGN PRECAUTIONS]

### WARNING

- When controlling a running programmable controller (data modification) by connecting a peripheral device to the CPU module or a PC to a special function module, create an interlock circuit on sequence programs so that the whole system functions safely all the time.  
Also, before performing any other controls (e.g. program modification, operating status change (status control)), read the manual carefully and ensure the safety.  
In these controls, especially the one from an external device to a programmable controller in a remote location, some programmable controller side problem may not be resolved immediately due to failure of data communications.  
To prevent this, create an interlock circuit on sequence programs and establish corrective procedures for communication failure between the external device and the programmable controller CPU.
- When setting up the system, do not allow any empty slot on the base unit. If any slot is left empty, be sure to use a blank cover (A1SG60) or a dummy module (A1SG62) for it.  
When using the extension base unit, A1S52B, A1S55B or A1S58B, attach the included dustproof cover to the module in slot 0.  
Otherwise, internal parts of the module may be fried in the short circuit test or when an overcurrent or overvoltage is accidentally applied to external I/O section.

### CAUTION

- Do not install the control lines or communication cables together with the main circuit or power lines, or bring them close to each other. Keep a distance of 100mm (3.94inch) or more between them. Failure to do so may cause malfunctions due to noise.
- When an output module is used to control the lamp load, heater, solenoid valve, etc., a large current (ten times larger than the normal one) may flow at the time that the output status changes from OFF to ON. Take some preventive measures such as replacing the output module with the one of a suitable current rating.
- Time from when the CPU module is powered on or is reset to when it enters in RUN status depends on the system configuration, parameter settings, and program size.  
Design the program so that the entire system will always operate safely, regardless of the time.

## [INSTALLATION PRECAUTIONS]

### CAUTION

- Use the programmable controller under the environment specified in the user's manual.  
Otherwise, it may cause electric shocks, fires, malfunctions, product deterioration or damage.
- Insert the module fixing projection into the fixing hole in the base unit and then tighten the module mounting screw within the specified torque.  
When no screw is tightened, even if the module is installed correctly, it may cause malfunctions, a failure or a drop of the module.  
Tightening the screw excessively may damage the screw and/or the module, resulting in a drop of the module, a short circuit or malfunctions.
- Connect the extension cable to the connector of the base unit or module.  
Check the cable for incomplete connection after connecting it.  
Poor electrical contact may cause incorrect inputs and/or outputs.
- Insert the memory card and fully press it to the memory card connector.  
Check for incomplete connection after installing it.  
Poor electrical contact may cause malfunctions.
- Be sure to shut off all phases of the external power supply used by the system before mounting or removing the module. Failure to do so may damage the module.
- Do not directly touch the conductive part or electronic components of the module.  
Doing so may cause malfunctions or a failure of the module.

## [WIRING PRECAUTIONS]

### WARNING

- Be sure to shut off all phases of the external power supply used by the system before wiring.  
Failure to do so may result in an electric shock or damage of the product.
- Before energizing and operating the system after wiring, be sure to attach the terminal cover supplied with the product.  
Failure to do so may cause an electric shock.

### CAUTION

- Always ground the FG and LG terminals to the protective ground conductor.  
Failure to do so may cause an electric shock or malfunctions.
- Wire the module correctly after confirming the rated voltage and terminal layout.  
Connecting a power supply of a different voltage rating or incorrect wiring may cause a fire or failure.
- Do not connect multiple power supply modules to one module in parallel.  
The power supply modules may be heated, resulting in a fire or failure.
- Press, crimp or properly solder the connector for external connection with the specified tool.  
Incomplete connection may cause a short circuit, fire or malfunctions.
- Tighten terminal screws within the specified torque range. If the screw is too loose, it may cause a short circuit, fire or malfunctions.  
If too tight, it may damage the screw and/or the module, resulting in a short circuit or malfunctions.
- Carefully prevent foreign matter such as dust or wire chips from entering the module.  
Failure to do so may cause a fire, failure or malfunctions.
- Install our programmable controller in a control panel for use.  
Wire the main power supply to the power supply module installed in a control panel through a distribution terminal block.  
Furthermore, the wiring and replacement of a power supply module have to be performed by a maintenance worker who acquainted with shock protection.  
(For the wiring methods, refer to Type A1SJH(S8)/A1SH/A2SHCPU(S1) User's Manual)

## [STARTUP AND MAINTENANCE PRECAUTIONS]

### WARNING

- Do not touch any terminal during power distribution.  
Doing so may cause an electric shock.
- Properly connect batteries. Do not charge, disassemble, heat or throw them into the fire and do not make them short-circuited and soldered. Incorrect battery handling may cause personal injuries or a fire due to exothermic heat, burst and/or ignition.
- Be sure to shut off all phases of the external power supply used by the system before cleaning or retightening the terminal screws or module mounting screws.  
Failure to do so may result in an electric shock.  
If they are too loose, it may cause a short circuit or malfunctions.  
If too tight, it may cause damage to the screws and/or module, resulting in an accidental drop of the module, short circuit or malfunctions.

### CAUTION

- When performing online operations (especially, program modification, forced output or operating status change) by connecting a peripheral device to the running CPU module, read the manual carefully and ensure the safety.  
Incorrect operation will cause mechanical damage or accidents.
- Do not disassemble or modify each of modules.  
Doing so may cause failure, malfunctions, personal injuries and/or a fire.
- When using a wireless communication device such as a mobile phone, keep a distance of 25cm (9.84inch) or more from the programmable controller in all directions.  
Failure to do so may cause malfunctions.
- Be sure to shut off all phases of the external power supply used by the system before mounting or removing the module.  
Failure to do so may result in failure or malfunctions of the module.
- Do not drop or apply any impact to the battery.  
Doing so may damage the battery, resulting in electrolyte spillage inside the battery.  
If any impact has been applied, discard the battery and never use it.
- Before handling modules, touch a grounded metal object to discharge the static electricity from the human body.  
Failure to do so may cause failure or malfunctions of the module.



## [DISPOSAL PRECAUTIONS]

### CAUTION

- When disposing of the product, treat it as an industrial waste.  
When disposing of batteries, separate them from other wastes according to the local regulations.  
(For details of the Battery Directive in EU member states, refer to User's manual to the CPU module used.)

## [TRANSPORTATION PRECAUTIONS]

### CAUTION

- When transporting lithium batteries, make sure to treat them based on the transportation regulations. (Refer to Appendix 2 for details of the relevant models.)

## ● PRÉCAUTIONS DE SÉCURITÉ ●

(Lire ces précautions avant toute utilisation du produit.)

Avant d'utiliser ce produit, lire attentivement ce manuel ainsi que les manuels auxquels il renvoie, et toujours considérer la sécurité comme de la plus haute importance en manipulant le produit correctement.

Dans ce manuel, les précautions de sécurité sont classées en deux niveaux, à savoir : "⚠️ AVERTISSEMENT" et "⚠️ ATTENTION"

### ⚠️ AVERTISSEMENT

Attire l'attention sur le fait qu'une négligence peut créer une situation de danger avec risque de mort ou de blessures graves.

### ⚠️ ATTENTION

Attire l'attention sur le fait qu'une négligence peut créer une situation de danger avec risque de blessures légères ou de gravité moyennes ou risque de dégâts matériels.

Dans certaines circonstances, le non-respect d'une précaution de sécurité introduite sous le titre "⚠️ ATTENTION" peut avoir des conséquences graves.

Les précautions de ces deux niveaux doivent être observées dans leur intégralité car elles ont trait à la sécurité des personnes et aussi du système.

Veiller à ce que les utilisateurs finaux lisent ce manuel qui doit être conservé soigneusement à portée de main pour s'y référer autant que de besoin.

## [PRÉCAUTIONS DE CONCEPTION]

### ⚠️ AVERTISSEMENT

- Prévoir un circuit de sécurité à l'extérieur de l'automate programmable permettant d'assurer la sécurité de fonctionnement de l'ensemble du système même en cas de coupure de l'alimentation externe ou de panne de l'automate programmable.

Faute de quoi, un sortie incorrect ou un dysfonctionnement pourrait causer un accident.

- (1) Comme circuit d'arrêt d'urgence, prévoir un circuit de protection avec limite de positionnement haute/basse pour la prévention des dommages, ainsi qu'un circuit d'interdiction des mouvements incompatibles comme la rotation avant/arrière, ces circuits devant toujours être configurés à l'extérieur de l'automate programmable.

Le bouton d'arrêt d'urgence doit être installé à l'extérieur du tableau de commande, facilement accessible par tous les ouvriers.

### **AVERTISSEMENT**

(2) *Quand l'automate programmable détecte l'un des états d'erreur ci-après, il interrompt la marche et il désactive les sorties.*

- *Le dispositif de protection contre les surtensions ou contre les surintensités du module d'alimentation a déclenché.*
- *La CPU d'automate programmable détecte les erreurs du genre erreur d'horloge de surveillance par sa fonction d'auto-diagnostic.*

*Dans l'éventualité d'une erreur affectant un organe de commande E/S et ne pouvant être détectée par la CPU de l'automate programmable, toutes les sorties pourraient devenir actives. Pour maintenir la sécurité de fonctionnement de toutes les machines, prévoir un circuit de mise en sécurité ou un mécanisme adéquat à l'extérieur de l'automate programmable.*

*Pour les exemples de circuit de mise en sécurité, voir la "CHARGEMENT ET INSTALLATION" dans ce manuel.*

(3) *En cas de défaillance d'un relais ou d'un transistor du module de sortie, les sorties peuvent rester inopinément à l'état ON ou à l'état OFF. Pour les signaux de sortie qui pourrait être à l'origine d'un accident grave, créer un circuit de surveillance externe.*

● *Si le courant de charge excède la valeur nominale ou si une surintensité circule longtemps dans le module de sortie suite à une court-circuit, il y a risque de départ de feu ou de dégagement de fumée. Prévoir un organe de sécurité externe, par exemple un fusible.*

● *Prévoir le circuit en sorte que l'alimentation externe soit disponible après la mise sous tension de l'automate programmable.*

*Le branchement de l'alimentation externe avant la mise en marche de l'automate programmable pourrait produire un signal de sortie erroné ou un dysfonctionnement à l'origine d'un accident.*

● *Quant à l'état opérationnel de chaque station dans l'éventualité d'une erreur de communication, voir le manuel de la liaison de données correspondante. Une erreur de communication peut être à l'origine d'un accident par suite d'une sortie incorrecte ou d'un dysfonctionnement.*



## **AVERTISSEMENT**

- *Pour toute intervention sur un automate programmable en marche (modifications des données) à partir d'un périphérique raccordé au module CPU ou à partir d'un PC raccordé à un module fonctionnel spécial, créer dans les programmes séquentiels un circuit de verrouillage assurant en tous temps la sécurité de fonctionnement de l'ensemble du système.  
De plus, avant l'exécution de toute autre instruction (comme une modification de programme ou un changement d'état opérationnel (commande d'état)), lire attentivement le manuel pour opérer en toute sécurité.  
Pour ces commandes, en particulier celles émanant d'un dispositif externe vers un automate programmable distant, les problèmes survenant côté automate programmable ne peuvent pas être immédiatement résolus en cas d'anomalie dans la communication des données.  
Pour éviter cela, prévoir un circuit de verrouillage dans les programmes séquentiels, et définir le mode opératoire applicable en cas d'erreur de communication entre le dispositif externe et la CPU d'automate programmable.*
- *Au montage du système, il ne doit rester aucune fente à carte vide sur l'unité de base.  
S'il reste une fente à carte vide, il est indispensable de la boucher avec un couvercle d'obturation (A1SG60) ou d'y insérer un module factice (A1SG62).  
Si on utilise une unité de base d'extension A1S52B, A1S55B ou A1S58B, recouvrir la fente 0 du module avec le couvercle de propriété fourni.  
Faute de quoi, il peut y avoir claquage des organes internes du module lors d'un essai de court-circuit ou en cas de surintensité ou de surtension appliquée accidentellement à la section externe des E/S.*

## **[PRÉCAUTIONS DE CONCEPTION]**



### **ATTENTION**

- *Ne pas installer les lignes de commande et les câbles de communication avec les lignes des circuits principaux ou de l'alimentation, et ne pas les placer à proximité les uns des autres.*

*Les installer en maintenant entre eux une distance minimum de 100mm (3,94 pouces).*

*Faute de quoi, les bruits parasites produiront des dysfonctionnements.*

- *Quand un module de sortie commande un accessoire comme une lampe, un réchauffeur, une électrovanne etc., un fort courant (jusqu'à dix fois la valeur normale) circule momentanément lors du changement d'état de OFF à ON. Il faut en tenir compte en remplaçant si nécessaire le module de sortie module de sortie par un autre ayant une capacité de courant suffisante.*

- *Le temps nécessaire à l'entrée en état RUN après la mise sous tension ou le réarmement du module CPU dépend de la configuration du système, du paramétrage et de la taille du programme.*

*Concevoir le programme de manière que tout le système fonctionne en sécurité, indépendamment de ce délai.*

## [PRÉCAUTIONS D'INSTALLATION]

### **ATTENTION**

- *Utiliser l'automate programmable dans l'environnement prescrit par le manuel de l'utilisateur.  
Faute de quoi, il y a risque de chocs électriques, de départ de feu, de dysfonctionnements ou d'endommagement du produit.*
- *Introduire l'ergot de fixation du module dans le trou correspondant sur l'unité de base et serrer les vis de fixation du module au couple prescrit.  
Si on ne serre pas la vis, même si le module a bien pris sa place, il peut y avoir dysfonctionnement, panne ou même chute du module.  
Un serrage excessif pourrait endommager la vis et/ou le module et il y aurait aussi risque de chute du module, de court-circuit ou de dysfonctionnements.*
- *Raccorder le câble d'extension sur le connecteur de l'unité de base ou du module. Vérifier qu'il n'y a pas de connexion imparfaite après raccordement du câble.  
Un mauvais contact électrique peu produire des entrées et/sorties erratiques.*
- *Insérer la carte-mémoire en la poussant à fond dans le connecteur pour carte-mémoire. Après installation, vérifier qu'il n'y a pas de connexions incomplètes.  
Un mauvais contact électrique peut être à l'origine de dysfonctionnements.*
- *Avant la mise en place ou le retrait du module, vérifier que l'alimentation externe utilisée par le système a bien été coupée sur toutes les phases. Faute de quoi, il y aurait risque d'endommagement du module.*
- *Éviter tout contact direct avec les parties conductrices ou composants électroniques du module.  
Cela pourrait être à l'origine de dysfonctionnements ou d'une panne du module.*

## **[PRÉCAUTIONS DE CABLAGE]**



### **AVERTISSEMENT**

- *Avant le câblage, vérifier que l'alimentation externe utilisée par le système a bien été coupée sur toutes les phases.  
Faute de quoi, il y aurait risque de choc électrique ou d'endommagement du produit.*
- *En fin de câblage, avant de mettre sous tension le système pour la mise en marche, mettre en place le couvre-bornes fourni avec le produit.  
Faute de quoi, il y aurait risque de choc électrique.*

## **[PRÉCAUTIONS DE CABLAGE]**

### **ATTENTION**

- *Toujours mettre à la masse les bornes FG et LG sur le conducteur de protection de terre.  
Faute de quoi, il y aurait risque de choc électrique ou de dysfonctionnement.*
- *Câbler le module correctement après vérification de la tension nominale et de l'affectation des bornes.  
Le raccordement d'une alimentation de tension nominale différente ou toute erreur de câblage peuvent être à l'origine d'un départ de feu ou d'une panne.*
- *Ne pas raccorder plusieurs modules d'alimentation en parallèle sur un même module.  
La surchauffe des modules d'alimentation pourrait entraîner un départ de feu ou être à l'origine d'une panne.*
- *Presser, sertir ou braser correctement le connecteur pour connexion externe en utilisant l'outil prescrit.  
Une connexion imparfaite peut être à l'origine d'un court-circuit, d'un départ de feu ou de dysfonctionnements.*
- *Serrer les vis de bornes dans les limites du couple de serrage prescrit. Une vis desserrée peut être à l'origine d'un court-circuit, d'un départ de feu ou de dysfonctionnements.  
Un serrage excessif peut endommager les vis et/ou le module et provoquer un court-circuit ou des dysfonctionnements.*
- *Prendre grand soin de ne laisser pénétrer dans le module aucun corps étranger, poussière, débris de fil ou autres.  
Faute de quoi, il y a risque de départ de feu, de panne ou de dysfonctionnement.*
- *Installer l'automate programmable dans un tableau de commande.  
Pour le câblage de l'alimentation principale vers le module d'alimentation installé en tableau de commande, utiliser un bloc de distribution.  
En outre, le câblage et le remplacement d'un module d'alimentation ne doivent être effectués que par un personnel de maintenance formé à la protection contre les chocs électriques.  
(Quand aux méthodes de câblage, voir le manuel de l'utilisateur des types A1SJH(S8)/A1SH/A2SHCPU(S1).)*





## **AVERTISSEMENT**

- *Ne toucher à aucune des bornes quand l'équipement est sous tension. Il aurait risque de choc électrique.*
- *Raccorder les batteries correctement. Ne pas recharger, démonter, chauffer ou jeter au feu, et ne pas court-circuiter ou souder les bornes. Un mauvais traitement des batteries pourrait être à l'origine de blessures ou produire un départ de feu s'il y a dégagement de chaleur, explosion et/ou inflammation.*
- *Avant le nettoyage ou le resserrage des vis de borne ou des vis de fixation du module, vérifier que l'alimentation externe utilisée par le système a bien été coupée sur toutes les phases.*

*Faute de quoi, il y aurait risque de choc électrique.*

*Desserrées, elles peuvent causer un court-circuits ou des dysfonctionnements.*

*Un serrage excessif peut endommager les vis et/ou le module et, en cas de chute, provoquer un court-circuit ou des dysfonctionnements.*

 **ATTENTION**

- *Pour toute intervention en ligne (en particulier, pour une modification de programme, une sortie forcée ou un changement d'état opérationnel) par raccordement d'un périphérique au module CPU en marche, lire attentivement le manuel pour opérer en toute sécurité. Une manœuvre incorrecte peut être à l'origine de dégâts matériels ou d'accidents.*
- *Ne pas démonter ou tenter de modifier les modules.  
Cela pourrait être à l'origine de pannes, dysfonctionnements, blessures et/ou d'un départ de feu.*
- *Pour utiliser un appareil de communication sans fil, comme un téléphone portable, le tenir éloigné de l'automate programmable d'une distance d'au moins 25cm (9,84 pouces), dans tous les sens.  
Faute de quoi, il y aurait risque de dysfonctionnements.*
- *Avant la mise en place ou le retrait du module, vérifier que l'alimentation externe utilisée par le système a bien été coupée sur toutes les phases.  
Faute de quoi, il peut en résulter des pannes ou dysfonctionnements de modules.*
- *Ne pas faire tomber la pile et ne pas l'exposer à des chocs.  
Cela pourrait endommager la batterie et entraîner une fuite de l'électrolyte que contient la batterie.  
Une pile qui a subi un choc ne doit jamais être utilisée mais mise au rebut.*
- *Avant de manipuler les modules, toucher un objet métallique raccordé à la terre pour éliminer la charge d'électricité statique qu'accumule le corps humain.  
Faute de quoi, il y aurait risque de panne ou de dysfonctionnement du module.*

## **[PRÉCAUTIONS DE MISE AU REBUT]**

### **ATTENTION**

- *Pour le mettre au rebut, ce produit doit être traité comme un déchet industriel. Les piles ou batteries doivent être mises au rebut séparément des autres déchets et conformément à la réglementation locale.  
(Pour le détail de la Directive sur les piles et batteries dans les états membres de l'UE, voir le manuel de l'utilisateur du module CPU utilisé.)*

## **[PRÉCAUTIONS DE TRANSPORT]**

### **ATTENTION**

- *Pour le transport des batteries et piles au lithium, toujours respecter la réglementation afférente au transport de ce genre de marchandises. (Pour le détail des modèles concernés, Voir Annexe 2.)*

## ●安全注意事项●

(使用之前请务必阅读)

在使用本产品之前，应仔细阅读本手册以及本手册中所介绍的相关手册，同时在充分注意安全的前提下正确操作。

在“安全注意事项”中，安全注意事项被分为“警告”和“注意”两个等级。



**警告**

表示错误操作可能造成危险后果，导致死亡或重伤事故。

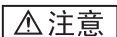

**注意**

表示错误操作可能造成危险后果，导致中度伤害、轻伤或财产损失。

此外，根据情况不同，即使标注为“注意”的事项也有可能引发严重后果。这两个等级的注意事项记载的均为重要内容，请务必遵守。

请妥善保管本手册以备需要时取阅，并将本手册交给最终用户。

### 【设计注意事项】

#### 警告

- 应在可编程控制器外部设置一个安全电路，以保证整个系统在外外部电源异常或可编程控制器本体故障时也能安全运行。

否则可能由于误输出、误动作而导致事故发生。

(1) 应在可编程控制器外部配置紧急停止电路、保护电路、正转 / 反转等相反动作的互锁电路、定位的上限 / 下限等防止机械破损的互锁电路等。

(2) 可编程控制器在检测到下列异常状态时，会停止运算并 OFF 所有输出。

- 电源模块的过电流保护装置或过电压保护装置工作时。

- 可编程控制器 CPU 通过看门狗定时器出错等自诊断功能检测到异常时。

此外，出现可编程控制器 CPU 所无法检测到的输入输出控制部分等的异常时，所有输出可能会为 ON。此时，应在可编程控制器外部设置一个失效安全电路或装置，以保证设备安全运行。关于失效安全电路的示例，请参照本手册的“实际安装与设置”。

(3) 输出模块的继电器以及晶体管等的故障可能会导致输出保持 ON 状态或 OFF 状态。对于可能导致重大事故发生的输出信号，应在外部设置监视电路。

- 输出模块因为超过额定的负载电流或负载短路等导致长时间过电流时，可能会导致冒烟、火灾，因此请在外部设置保险丝等安全电路。

- 应配置成在可编程控制器本体电源接通后再接通外部供应电源的电路。

如果外部供应电源先接通，可能由于误输出或误动作而导致事故发生。

## 【设计注意事项】

### ⚠ 警告

- 关于数据链接出现通信异常时各站的动作状态，请参照各数据链接的手册。否则可能由于误输出、误动作而导致事故发生。
- 在 CPU 模块上连接外围设备，或在特殊功能模块上连接计算机等以对运行中的可编程控制器进行控制（数据更改）前，应在顺控程序上配置互锁电路，以保证整个系统始终能安全运行。  
此外，对运行中的可编程控制器进行其他控制（程序更改、运行状态更改（状态控制））前，应仔细阅读相关手册，在充分确认安全的基础上进行操作。  
特别是在通过外部设备对远程的可编程控制器进行上述控制时，可能会因为数据通信异常而导致无法立即对可编程控制器侧的故障做出反应。  
在顺控程序上配置互锁电路的同时，应在外部设备与可编程控制器 CPU 之间确定发生数据通信异常时的系统的处理方法。
- 配置系统时，请勿在基板上设置空余插槽。  
出现空余插槽时，必须使用空槽盖板（A1SG60）、虚拟模块（A1SG62）。  
此外，使用扩展基板 A1S52B、A1S55B、A1S58B 时，必须在 0 号插槽的模块上安装附带的防尘盖板。  
进行短路试验时，或误对外部输入输出部施加过电流或过电压时，模块的内部部件可能会四处飞散。

### ⚠ 注意

- 请勿将控制线及通信电缆与主电路及动力线等捆扎在一起或相互靠得太近。应相距大约 100mm 以上距离。  
因为噪声有可能导致误动作。
- 通过输出模块控制指示灯负载、加热器、电磁阀等时，输出 OFF → ON 时可能会有大电流（通常的 10 倍左右）流过，因此请采取改用具有足够额定电流的输出模块等措施。
- CPU 模块的电源关闭 → 接通或复位时，CPU 模块变为 RUN 状态为止的时间会因系统配置、参数设置、程序容量等而变动。  
应通过设计使得在变为 RUN 状态为止的时间发生变动时也能保证整个系统安全运行。

## 【安装注意事项】

### ⚠ 注意

- 应在本手册记载的一般规格环境下使用可编程控制器。如果在一般规格范围以外的环境中使用可编程控制器，可能导致触电、火灾、误动作、产品损坏或性能劣化。
- 请将模块下部的模块固定用凸起部切实插入基板的固定孔后，以规定的扭矩拧紧模块安装螺栓。  
如果模块未正确安装并以螺栓固定，有可能造成误动作、故障或掉落。  
如果螺栓拧得过紧，有可能造成螺栓及模块破损从而导致掉落、短路或误动作。
- 扩展电缆应切实安装到基板的扩展电缆用接口上。  
安装后应检查有无浮起。  
因为接触不良有可能导致误输入、误输出。
- 存储卡盒应按入存储卡盒安装用接口中并切实安装。  
安装后应检查有无浮起。  
因为接触不良有可能导致误动作。
- 在拆装模块时，必须将系统使用的外部供应电源全部断开后再进行操作。  
如果未全部断开，有可能导致产品损坏。
- 请勿直接触碰模块的导电部分及电子部件。  
否则可能导致模块误动作、故障。

## 【配线注意事项】

### ⚠ 警告

- 在配线作业等时，必须将系统使用的外部供应电源全部断开后再进行操作。  
如果未全部断开，有可能导致触电或产品损坏。
- 配线作业结束后进行通电、运行时，必须安装产品附带的端子盖板。  
如果未安装端子盖板，有可能导致触电。

### ⚠ 注意

- 必须将 FG 端子及 LG 端子与可编程控制器的专用接地线连接。  
否则有可能导致触电、误动作。
- 进行模块配线作业时，应在确认产品的额定电压及端子排列的基础上正确进行操作。  
如果连接了与额定值不符的电源或配线错误，可能导致火灾或故障。
- 请勿将多个电源模块的输出并联。  
否则电源模块会过热，可能导致火灾或故障。
- 外部连接用接口应使用生产厂商指定的工具进行压装、压接或正确焊接。  
如果连接不牢固，可能导致短路、火灾或误动作。
- 应在规定的扭矩范围内拧紧端子螺栓。  
如果端子螺栓拧得过松，有可能导致短路、火灾或误动作。  
如果端子螺栓拧得过紧，有可能造成螺栓及模块破损从而导致掉落、短路或误动作。
- 应注意防止切屑及配线头等异物掉入模块内。  
否则有可能导致火灾、故障或误动作。
- 本公司的可编程控制器应设置在控制盘内使用。  
与设置在控制盘内的可编程控制器电源模块之间的主电源配线应经由中继端子排进行。  
此外，电源模块的更换和配线作业应由接受过充分的触电防护教育的维护作业人员进行。  
配线方法请参照 A1SJHCPU/A1SHCPU/A2SHCPU 用户手册（详细篇）。

## 【启动 / 维护注意事项】

### 警告

- 在通电状态下请勿触摸端子。  
否则可能导致触电。
- 应正确连接电池。  
请勿进行充电、拆解、加热、投入火中、短接、焊接等。  
如果错误使用电池，有可能因为电池发热、破裂或起火等而导致人身伤害或火灾。
- 在清洁模块或重新紧固端子螺栓、模块安装螺栓时，必须将系统使用的外部供应电源全部断开后再进行操作。  
如果未全部断开，有可能导致触电。  
如果端子螺栓拧得过松，有可能导致短路、误动作。  
如果螺栓拧得过紧，有可能造成螺栓及模块破损从而导致掉落、短路或误动作。

### 注意

- 把外围设备连接到运行中的 CPU 模块上进行在线操作（特别是程序更改、强制输出、运行状态的更改）前，应仔细阅读手册，在充分确认安全的基础上进行操作。  
否则操作错误有可能导致机械破损或事故发生。
- 请勿拆解或改造各模块。  
否则可能导致故障、误动作、人身伤害或火灾。
- 便携电话或 PHS 等无线通信设备应在距离可编程控制器本体（各个方向）25cm 以上的地方使用。  
否则可能导致误动作。
- 在拆装模块时，必须将系统使用的外部供应电源全部断开后再进行操作。  
如果未全部断开，有可能导致模块故障或误动作。
- 请勿使模块中安装的电池掉落或受到撞击。  
掉落或受到撞击可能会导致电池破损，造成电池内部发生漏液。  
掉落或受到撞击的电池不可使用，应予以报废。
- 产品投入使用后，端子排的拆装次数不应超过 50 次。  
（根据 IEC61131-2 规范）
- 在触碰模块之前，必须先触碰已接地的金属等，释放掉人体等所携带的静电。  
如果不释放掉静电，有可能导致模块故障或误动作。



### 【报废处理注意事项】

#### ⚠ 注意

- 本产品报废时，应当作为工业废物处理。  
电池报废时应根据各地区所制定的法律法规分别进行。  
(关于欧盟成员国的电池管制的详细内容，请参照 A1SJHCPU/A1SHCPU/A2SHCPU 用户手册 (详细篇)。)

### 【运输注意事项】

#### ⚠ 注意

- 在运输含锂电池时，应根据运输管制进行处理。(管制对象机种的详细内容请参照附.2。)

## ● CONDITIONS OF USE FOR THE PRODUCT ●

- (1) Mitsubishi programmable controller ("the PRODUCT") shall be used in conditions;
  - i) where any problem, fault or failure occurring in the PRODUCT, if any, shall not lead to any major or serious accident; and ii) where the backup and fail-safe function are systematically or automatically provided outside of the PRODUCT for the case of any problem, fault or failure occurring in the PRODUCT.
- (2) The PRODUCT has been designed and manufactured for the purpose of being used in general industries.

MITSUBISHI SHALL HAVE NO RESPONSIBILITY OR LIABILITY (INCLUDING, BUT NOT LIMITED TO ANY AND ALL RESPONSIBILITY OR LIABILITY BASED ON CONTRACT, WARRANTY, TORT, PRODUCT LIABILITY) FOR ANY INJURY OR DEATH TO PERSONS OR LOSS OR DAMAGE TO PROPERTY CAUSED BY the PRODUCT THAT ARE OPERATED OR USED IN APPLICATION NOT INTENDED OR EXCLUDED BY INSTRUCTIONS, PRECAUTIONS, OR WARNING CONTAINED IN MITSUBISHI'S USER, INSTRUCTION AND/OR SAFETY MANUALS, TECHNICAL BULLETINS AND GUIDELINES FOR the PRODUCT.

("Prohibited Application")

Prohibited Applications include, but not limited to, the use of the PRODUCT in;

- Nuclear Power Plants and any other power plants operated by Power companies, and/or any other cases in which the public could be affected if any problem or fault occurs in the PRODUCT.
- Railway companies or Public service purposes, and/or any other cases in which establishment of a special quality assurance system is required by the Purchaser or End User.
- Aircraft or Aerospace, Medical applications, Train equipment, transport equipment such as Elevator and Escalator, Incineration and Fuel devices, Vehicles, Manned transportation, Equipment for Recreation and Amusement, and Safety devices, handling of Nuclear or Hazardous Materials or Chemicals, Mining and Drilling, and/or other applications where there is a significant risk of injury to the public or property.

Notwithstanding the above, restrictions Mitsubishi may in its sole discretion, authorize use of the PRODUCT in one or more of the Prohibited Applications, provided that the usage of the PRODUCT is limited only for the specific applications agreed to by Mitsubishi and provided further that no special quality assurance or fail-safe, redundant or other safety features which exceed the general specifications of the PRODUCTS are required. For details, please contact the Mitsubishi representative in your region.

## REVISIONS

\*The manual number is given on the bottom right of the front cover.

Print Date	*Manual Number	Revision
Mar., 1994	IB(NA) 66469-A	First edition
Oct., 1995	IB(NA) 66469-B	
Jan., 1996	IB(NA) 66469-C	
Jun., 1997	IB(NA) 66469-D	
Sep., 1998	IB(NA) 66469-E	<p><b>Correction</b> Safety precautions, Chapter1, Chapter2, Chapter3, Chapter4, Chapter5</p> <p><b>Deletion</b> Notification of CE marking, Chapter6, Chapter7, Appendix</p>
Jan., 2003	IB(NA) 66469-F	<p>Equivalent to Japanese version J</p> <p><b>Partial additions</b> 5.1, 5.2</p> <p><b>Partial corrections</b> Safety precautions, 1.1, 3, 4.2, 4.4, 4.5.1, 4.5.2, 6.1.1</p>
Jun., 2003	IB(NA) 66469-G	<p><b>Partial corrections</b> Safety precautions, Section 6.1.1</p> <p><b>Addition</b> Appendix 2</p>
Dec., 2003	IB(NA) 66469-H	<p><b>Addition of model</b> A1SY42P</p> <p><b>Partial corrections</b> Section 3.1.4, 4.2, 5.2.1, 5.2.2</p>
Jun., 2006	IB(NA) 66469-I	<p><b>Partial corrections</b> Safety precautions, Section 2.1, Chapter3, Section 3.1, 3.1.3, 3.2, 3.2.1, 4.4, 4.5.1, 4.5.2, 6.1.1</p> <p><b>Addition</b> USER PRECAUTIONS, Section 4.5.3</p>
Oct., 2006	IB(NA) 66469-J	<p><b>Partial corrections</b> Safety precautions, Section 1.1, Chapter3, Section 3.1.3, 3.2.4, 4.1.1.4.1.3, 4.3.2, 4.3.3, 4.5, 5.2.1, 5.2.2, 6.1</p>
May, 2007	IB(NA) 66469-K	<p><b>Partial corrections</b> Section 3.1.1, 3.1.3, 3.2.7, 4.3.2, 4.3.3, 5.1.2, 5.2.1</p> <p><b>Addition</b> Section 3.1.7</p>
Oct., 2008	IB(NA) 66469-L	<p><b>Partial corrections</b> SAFETY PRECAUTIONS, USER PRECAUTIONS, Section 3.1, 3.1.1, 3.1.2, 3.1.3, 3.2, 3.2.3, 3.2.5, 3.2.6, 3.2.7, 4.1.3, 4.2, 4.3.1, 4.3.2, 4.3.3, 5.1.1, 5.2.1, 5.2.2</p>

\*The manual number is given on the bottom right of the front cover.

Print Date	*Manual Number	Revision
Jul., 2009	IB(NA) 66469-M	[Partial corrections] SAFETY PRECAUTIONS, Section 1.1, Chapter3
Jan., 2011	IB(NA) 66469-N	[Partial corrections] SAFETY PRECAUTIONS, Related manuals, Section 1.1, 3.1, Capter 3, Section 3.1, 3.1.1, 3.1.3, 3.1.4, 3.1.5, 3.1.7, 4.2, 4.3.2, Capter 5, Section 6.2 [Addition] CONDITIONS OF USE FOR THE PRODUCT
Dec., 2011	IB(NA) 66469-O	[Partial corrections] Section 1.1, 3.1.1 [Addition] SAFETY PRECAUTIONS (Chinese)
Jun., 2014	IB(NA) 66469-P	[Partial corrections] Section 1.1, 3.1.2, 4.1.1, 4.3.1, 4.3.3, 5.1.2, 5.2.2, 5.3.2 [Addition] SAFETY PRECAUTIONS(French)

Japanese Manual Version IB(NA)-68408-T

This manual confers no industrial property rights or any rights of any other kind, nor does it confer any patent licenses. Mitsubishi Electric Corporation cannot be held responsible for any problems involving industrial property rights which may occur as a result of using the contents noted in this manual.

---

---

# CONTENTS

---

---

1. SPECIFICATIONS .....	1
1.1 SPECIFICATIONS .....	1
2. PERFORMANCE SPECIFICATIONS .....	3
2.1 Performance Specifications .....	3
3. EMC DIRECTIVES AND LOW VOLTAGE DIRECTIVES .....	5
3.1 Requirements for Compliance with EMC Directives .....	5
3.1.1 EMC standards .....	6
3.1.2 Installation instructions for EMC Directive .....	8
3.1.3 Cables .....	10
3.1.4 Power supply module .....	17
3.1.5 Ferrite core .....	17
3.1.6 Noise filter (power supply line filter) .....	18
3.1.7 Power line for external power supply terminal .....	18
3.1.8 Installation environment of the CC-Link/LT module and the AS-i module .....	19
3.2 Requirements for Compliance with Low Voltage Directives .....	20
3.2.1 Standard applied for MELSEC-AnS series programmable controller .....	20
3.2.2 Precautions when using the MELSEC-AnS series programmable controller .....	21
3.2.3 Power supply .....	22
3.2.4 Control panel .....	22
3.2.5 Module installation .....	24
3.2.6 Grounding .....	24
3.2.7 External wiring .....	24
4. LOADING AND INSTALLATION .....	25
4.1 Installing the Module .....	25
4.1.1 Notes on handling the module .....	25
4.1.2 Installation environment .....	27
4.1.3 Notes on installing the base unit .....	28
4.2 Fail-Safe Circuit Concept .....	31
4.3 Wiring .....	36
4.3.1 Performance specifications for the A1SJHCPU built-in power supply .....	36
4.3.2 The precautions on the wirings .....	38
4.3.3 Wiring to module terminals .....	42
4.4 Precautions when Connecting the Uninterruptible Power Supply (UPS) .....	44
4.5 Parts of the CPU .....	45

5. SPECIFICATION AND CONNECTION OF I/O MODULES .....	49
5.1 Input modules .....	49
5.1.1 Input module specifications .....	49
5.1.2 Input module connections .....	53
5.2 Output modules .....	59
5.2.1 Output module specifications .....	59
5.2.2 Output module connections .....	65
5.3 Input/output combined modules .....	77
5.3.1 Input/output combined module specifications .....	77
5.3.2 Input/output composite module connections .....	79
6. ERROR CODES .....	83
6.1 Error Code List .....	83
6.2 Error Codes .....	84
APPENDICES .....	96
Appendix 1 CPU-by-CPU Startup Names .....	96
Appendix 2 Transportation Precautions .....	96
Appendix 2.1 Relevant Models .....	96
Appendix 2.2 Transportation Guidelines .....	96

This manual describes EMC standards and Low-Voltage instructions the handling precautions, and error codes of: A1SJHCPU (abbreviated to CPU in this manual)

Manuals
---------

The manuals related to A1SJHCPU are listed below.  
Refer to the following manuals when necessary.

## Detailed manuals

Manual Name	Manual No. (Model Code)
type A1SJH/A1SH/A2SHCPU(S1) User's manual Provides information on the performance, specifications, handling, etc. of the A1SJHCPU/A1SHCPU/A2SHCPU(S1) and on the memory cassette specifications and handling. (Sold separately)	IB-66779 (13JL22)

## Related manuals

Manual Name	Manual No. (Model Code)
Type ACPU/QCPU-A (A Mode) Programming Manual (Fundamentals) Describes programming methods necessary for creating programs, device names, parameters, program types, memory area configuration, and so on. (Sold separately)	IB-66249 (13J740)
Type ACPU/QCPU-A (A Mode) Programming Manual (Common Instructions) Describes how to use the sequence instruction, basic instructions, applied instructions and microcomputer programs. (Sold separately)	IB-66250 (13J741)
Type AnSHCPU/AnACPU/AnUCPU/QCPU-A (A Mode) Programming Manual (Dedicated Instructions) Describes instructions that have been expanded for A1SJHCPU/A1SHCPU/A2SHCPU(S1). (Sold separately)	IB-66251 (13J742)
AnS Module type I/O User's Manual Describes the specification of the compact building block type I/O module. (Sold separately)	IB-66541 (13JE81)



## USER PRECAUTIONS

### Precautions when using the AnS series

For a new CPU module, which has never used before, the contents of built-in RAM and device data are undefined.

Make sure to clear the built-in RAM memory (PC memory all clear) in the CPU module by peripheral devices and operate latch clear by RUN/STOP key switches.

### Precautions for battery

- (1) The operation after a battery is unmounted and the programmable controller is stored.

When reoperating after a battery is uncounted and the programmable controller is stored, the contents of built-in RAM and device data may be undefined. For this reason, make sure to clear the built-in RAM memory (PC memory all clear) in the CPU module by peripheral devices and operate latch clear by RUN/STOP key switch before start the operation again.

- (2) If a battery exceeded its guaranteed life is stored and reoperated. If a battery exceeded its guaranteed life is stored and reoperated, the contents of built-in RAM and device data may be undefined. For this reason, make sure to clear the built-in RAM memory (PC memory all clear) in the CPU module by peripheral devices and operate latch clear by RUN/STOP key switches before start the operation again.

After the built-in RAM clear and latch clear of the CPU module, write the backed-up memory contents to the CPU module before saving.

POINT
-------

Make sure to back-up each memory contents before storing the programmable controller.
---

- \* Refer to the following manuals for details of built-in RAM clear (programmable controller memory all clear) by peripheral devices.
- GX Developer Operating Manual
  - A6GPP/A6PHP Operating Manual
  - SW□SRX/SW□NX/SW□IVD-GPPA Operating Manual
- Refer to Section 4.5 for latch clear operation by RUN/STOP key switch of the CPU module.

# 1. SPECIFICATIONS

## 1.1 SPECIFICATIONS

Table 1.1 General specification

Item	Specifications					
Operating ambient temperature <i>Température ambiante de fonctionnement</i>	0 to 55 °C 0 à 55 °C					
Storage ambient temperature	-20 to 75 °C					
Operating ambient humidity	10 to 90%RH, non-condensing					
Storage ambient humidity						
Vibration resistance *4	Compliant with JIS B 3502 and IEC 61131-2	Under intermittent vibration	Frequency	Constant acceleration	Half amplitude	Sweep count
			5 to 9Hz	-	3.5mm	10 times each in X, Y, Z directions
		Under continuous vibration	9 to 150Hz	9.8m/s <sup>2</sup>	-	
			5 to 9Hz	-	1.75mm	
9 to 150Hz	4.9m/s <sup>2</sup>	-				
Shock resistance	Compliant with JIS B 3502 and IEC 61131-2 (147 m/s <sup>2</sup> , 3 times each in 3 directions X, Y, Z)					
Operating atmosphere	No corrosive gases					
Operating altitude *3	0 to 2000m					
Installation location	Inside a control panel					
Over voltage category *1	II or less					
Pollution degree *2	2 or less					
Equipment class	Class I					

- \*1 This indicates the section of the power supply to which the equipment is assumed to be connected between the public electrical power distribution network and the machinery within premises.  
Category II applies to equipment for which electrical power is supplied from fixed facilities. The surge voltage withstand level for up to the rated voltage of 300V is 2500V.
- \*2 This index indicates the degree to which conductive material is generated in terms of the environment in which the equipment is used. Pollution level 2 is when only non-conductive pollution occurs. A temporary conductivity caused by condensing must be expected occasionally.
- \*3 Do not use or store the programmable controller under pressure higher than the atmospheric pressure of altitude 0m. Doing so may cause malfunction. When using the programmable controller under pressure, please consult your local Mitsubishi Electric representative.
- \*4 When an A series extension base unit (A52B, A55B, A58B, A62B, A68B) is used in the system, the following specifications apply.

	Frequency	Acceleration	Amplitude	Sweep count
Under intermittent vibration	10 to 57Hz	-	0.075mm	10 times each in X, Y, Z directions
	57 to 150Hz	9.8m/s <sup>2</sup>	-	
Under continuous vibration	10 to 57Hz	-	0.035mm	-
	57 to 150Hz	4.9m/s <sup>2</sup>	-	

## 2. PERFORMANCE SPECIFICATIONS

### 2.1 Performance Specifications

The memory capacities of A1SJHCPU module, performances of devices, etc., are presented below.

Table 2.1 Performance specifications

Item	Type	A1SJHCPU
Control system		Repeated operation (using stored program)
I/O control method		Refresh mode/Direct mode selectable
Programming language		Language dedicated to sequence control. Relay symbol type and logic symbolic language, MELSAP-II (SFC)
Number of instructions (types)		Sequence instructions : 26
		Basic instructions : 131
		Application instructions : 106
		CC-Link dedicated instructions : 8
Processing speed (sequence instruction)		Direct : 0.33 to 2.3 $\mu$ s/step Refresh : 0.33 $\mu$ s/step
Number of I/O device points		2048 *2
Number of I/O points		256
Watchdog timer (WDT)		10 to 2000 ms
Memory capacity *1 (built-in RAM)		64 k bytes
Program capacity	Main sequence	Max. 8 k steps
	Sub sequence	None
Self-diagnostics functions		Watchdog error monitor, Memory error detection, CPU error detection, I/O error detection, Battery error detection, etc.
Operation mode at the time of error		STOP/CONTINUE
STOP → RUN output mode		Output data at time of STOP restored/data output after operation execution
Clock function		Year, month, day, hour, minute, second (Automatically recognizes leap years.) Accuracy -3.1 to +5.3 s (TYP. +1.7 s)/d at 0 °C -1.6 to +5.3 s (TYP. +2.4 s)/d at 25°C -9.6 to +3.6 s (TYP. -2.1 s)/d at 55 °C
Allowable momentary power failure period		Depends on power supply module
Current consumption (5 V DC)		0.3 A
Weight		7.0 kg
Standard		UL/cUL

- \*1 The maximum total memory that can be used for parameters, T/C set values, program capacity, file registers, number of comments, sampling trace, and status latch is 32 k/64 k bytes. The memory capacity is fixed. No expansion memory is available.
- \*2 The I/O device after the actual input points can be used as MELSECNET(B), MELSECNET/mini-S3, or CC-Link.

---

## 3. EMC DIRECTIVES AND LOW VOLTAGE DIRECTIVES

---

The products sold in the European countries have been required by law to comply with the EMC Directives and Low Voltage Directives of the EU Directives since 1996 and 1997, respectively.

The manufacturers must confirm by self-declaration that their products meet the requirements of these directives, and put the CE mark on the products.

(1) Authorized representative in Europe

Authorized representative in Europe is shown below.

Name: Mitsubishi Electric Europe BV

Address: Gothaer Strasse 8, 40880 Ratingen, Germany

### 3.1 Requirements for Compliance with EMC Directives

The EMC Directives specifies emission and immunity criteria and requires the products to meet both of them, i.e., not to emit excessive electromagnetic interference (emission): to be immune to electromagnetic interference outside (immunity).

Guidelines for complying the machinery including MELSEC-AnS series programmable controller with the EMC Directives are provided in Section 3.1.1 to 3.1.8 below.

The guidelines are created based on the requirements of the regulations and relevant standards, however, they do not guarantee that the machinery constructed according to them will not comply with the Directives.

Therefore, the manufacturer of the machinery must finally determine how to make it comply with the EMC Directives: if it is actually compliant with the EMC Directives.

### 3.1.1 EMC standards

#### (1) Regulations regarding emission

Standard	Test item	Test description	Value specified in standard
EN61131-2: 2007	CISPR16-2-3 Radiated emission *2	Radio waves from the product are measured.	<ul style="list-style-type: none"><li>• 30M-230MHz QP: 40dB<math>\mu</math>V/m (10m in measurement range) *1</li><li>• 230M-1000MHz QP: 47dB<math>\mu</math>V/m (10m in measurement range)</li></ul>
	CISPR16-2-1, CISPR16-1-2 Conducted emission *2	Noise from the product to the power line is measured.	<ul style="list-style-type: none"><li>• 150k-500kHz QP: 79dB, Mean: 66dB *1</li><li>• 500k-30MHz QP: 73dB, Mean: 60dB</li></ul>

\*1 QP: Quasi-peak value, Mean: Average value

\*2 Programmable controllers are open-type devices (devices designed to be housed inside other equipment) and must be installed inside a conductive control panel. The corresponding tests were conducted with the programmable controller installed inside a control panel.

## (2) Regulations regarding immunity

Standard	Test item	Test description	Value specified in standard
EN61131-2: 2007	EN61000-4-2 Electrostatic discharge immunity *1	Immunity test in which electrostatic is applied to the cabinet of the equipment.	<ul style="list-style-type: none"> <li>• 8kV Air discharge</li> <li>• 4kV Contact discharge</li> </ul>
	EN61000-4-3 Radiated, radiofrequency, electromagnetic field immunity *1	Immunity test in which electric fields are irradiated to the product.	80% AM modulation@1kHz <ul style="list-style-type: none"> <li>• 80M-1000MHz: 10V/m</li> <li>• 1.4G-2.0GHz: 3V/m</li> <li>• 2.0G-2.7GHz: 1V/m</li> </ul>
	EN61000-4-4 Electrical fast transient/burst immunity *1	Immunity test in which burst noise is applied to the power line and signal line.	<ul style="list-style-type: none"> <li>• AC/DC main power, I/O power, AC I/O (unshielded): 2kV</li> <li>• DC I/O, analog, communication: 1kV</li> </ul>
	EN61000-4-5 Surge immunity *1	Immunity test in which lightning surge is applied to the power line and signal line.	<ul style="list-style-type: none"> <li>• AC power line, AC I/O power, AC I/O (unshielded) : 2kV CM, 1kV DM</li> <li>• DC power line, DC I/O power : 0.5kV CM, DM</li> <li>• DC I/O, AC I/O (shielded), analog *2, communication: 1kV CM</li> </ul>
	EN61000-4-6 Immunity to conducted disturbances, induced by radio-frequency fields *1	Immunity test in which high frequency noise is applied to the power line and signal line.	0.15M-80MHz, 80% AM modulation@1kHz, 10Vrms
	EN61000-4-8 Power-frequency magnetic field immunity *1	Immunity test in which the product is installed in inductive magnetic field.	50Hz/60Hz, 30A/m
	EN61000-4-11 Voltage dips and interruption immunity *1	Immunity test in which power supply voltage is momentarily interrupted.	<ul style="list-style-type: none"> <li>• Apply at 0%, 0.5 cycles and zero-cross point</li> <li>• 0%, 250/300 cycles (50/60Hz)</li> <li>• 40%, 10/12 cycles (50/60Hz)</li> <li>• 70%, 25/30 cycles (50/60Hz)</li> </ul>

\*1 Programmable controllers are open-type devices (devices designed to be housed inside other equipment) and must be installed inside a conductive control panel. The corresponding tests were conducted with the programmable controller installed inside a control panel.

\*2 The accuracy of an analog-digital converter module may temporary vary within  $\pm 10\%$ .



### 3.1.2 Installation instructions for EMC Directive

The programmable controller is open equipment and must be installed within a control cabinet for use.\* This not only ensures safety but also ensures effective shielding of programmable controller-generated electromagnetic noise.

- \* Also, each network remote station needs to be installed inside the control panel.  
However, the waterproof type remote station can be installed outside the control panel.

#### (1) Control cabinet

- (a) Use a conductive control cabinet.
- (b) When attaching the control cabinet's top plate or base plate, mask painting and weld so that good surface contact can be made between the cabinet and plate.
- (c) To ensure good electrical contact with the control cabinet, mask the paint on the installation bolts of the inner plate in the control cabinet so that contact between surfaces can be ensured over the widest possible area.
- (d) Earth the control cabinet with a thick wire so that a low impedance connection to ground can be ensured even at high frequencies.
- (e) Holes made in the control cabinet must be 10 cm (3.94 in.) diameter or less. If the holes are 10 cm (3.94 in.) or larger, radio frequency noise may be emitted.
- (f) Lock the control panel so that only those who are trained and have acquired enough knowledge of electric facilities can open the control panel.

(2) Connection of power and earth wires

Earthing and power supply wires for the programmable controller system must be connected as described below.

- (a) Provide an earthing point near the power supply module. Earth the power supply's LG and FG terminals (LG : Line Ground, FG : Frame Ground) with the thickest and shortest wire possible. (The wire length must be 30 cm (11.18 in.) or shorter.) The LG and FG terminals function is to pass the noise generated in the programmable controller system to the ground, so an impedance that is as low as possible must be ensured. In addition, make sure to wire the ground cable short as the wires are used to relieve the noise, the wire itself carries large noise content and thus short wiring means that the wire is prevented from acting as an antenna.
- (b) The earth wire led from the earthing point must be twisted with the power supply wires. By twisting with the earthing wire, noise flowing from the power supply wires can be relieved to the earthing. However, if a filter is installed on the power supply wires, the wires and the earthing wire may not need to be twisted.

### 3.1.3 Cables

The cables extracted from the control panel contain a high frequency noise component. On the outside of the control panel, therefore, they serve as antennas to emit noise. To prevent noise emission, use shielded cables for the cables which are connected to the I/O modules and intelligent function modules and may be extracted to the outside of the control panel.

The use of a shielded cable also increases noise resistance. The signal lines (including common line) of the programmable controller, which are connected to I/O modules, intelligent function modules and/or extension cables, have noise durability in the condition of grounding their shields by using the shielded cables. If a shielded cable is not used or not grounded correctly, the noise resistance will not meet the specified requirements.

#### (1) Earthing of shielded of cables

- (a) Earth the shield of the shielded cable as near the unit as possible taking care so that the earthed cables are not induced electromagnetically by the cable to be earthed.
- (b) Take appropriate measures so that the shield section of the shielded cable from which the outer cover was partly removed for exposure is earthed to the control panel on an increased contact surface. A clamp may also be used as shown in the figure below. In this case, however, apply a cover to the painted inner wall surface of the control panel which comes in contact with the clamp.

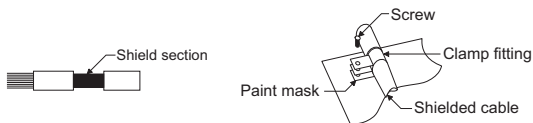

Note) The method of earthing by soldering a wire onto the shield section of the shielded cable as shown below is not recommended. The high frequency impedance will increase and the shield will be ineffective.

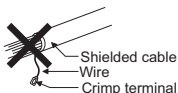

(2) MELSECNET (II) and MELSECNET/10 modules

- (a) Use a double-shielded coaxial cable for the MELSECNET module which uses coaxial cables such as A1SJ71AR21, A1SJ71LR21 and A1SJ71BR11. Noise in the range of 30 MHz or higher in radiation noise can be suppressed by the use of double-shielded coaxial cables (manufactured by MITSUBISHI CABLE INDUSTRIES, LTD: 5C-2V-CCY). Earth the outer shield to the ground.

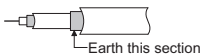

For the shield grounding, refer to item (1).

- (b) Make sure to attach a ferrite core to the double-shielded coaxial cable connected to the MELSECNET module. In addition, position the ferrite core on each cable near the outlet of the control panel. The ferrite core manufactured by TDK Corporation, ZCAT3035-1330, is recommended.

(3) Ethernet module

Precautions to be followed when AUI cables and coaxial cables are used are described below.

- (a) Always earth the AUI cables\*1 connected to the 10BASE5 connectors. Because the AUI cable is of the shielded type, strip part of the outer cover and earth the exposed shield section to the ground on the widest contact surface as shown below.

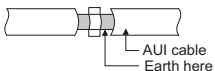

- (b) Use shielded twisted pair cables as the twisted pair cables\*1 connected to the 10BASE-T connectors. For the shielded twisted pair cables, strip part of the outer cover and earth the exposed shield section to the ground on the widest contact surface as shown below.

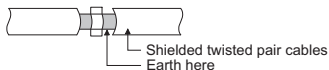

Refer to (1) for the earthing of the shield

\*1 Make sure to install a ferrite core for the cable.

The ferrite core manufactured by TDK Corporation, ZCAT2032-0930, is recommended.

- (c) Always use double-shielded coaxial cables as the coaxial cables\*2 connected to the 10BASE2 connectors. Earth the double-shielded coaxial cable by connecting its outer shield to the ground.

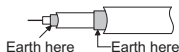

Refer to (1) for the earthing of the shield

- \*2 Make sure to install a ferrite core for the cable.

The ferrite core manufactured by TDK Corporation, ZCAT3035-1330, is recommended.

Ethernet is the registered trademark of XEROX, Co.,LTD

- (4) I/O and other communication cables

For the I/O signal lines (including common line) and other communication cables (RS-232, RS-422, etc), if extracted to the outside of the control panel, also ensure to earth the shield section of these lines and cables in the same manner as in item (1) above.

- (5) Positioning Modules

Precautions to be followed when the machinery conforming to the EMC Directive is configured using the A1SD75P□-S3 are described below.

- (a) When wiring with a 2 m (6.56 ft.) or less cable

- Ground the shield section of the external wiring cable with the cable clamp.  
(Ground the shield at the closest location to the A1SD75 external wiring connector.)
- Wire the external wiring cable to the drive unit and external device with the shortest practicable length of cable.
- Install the drive unit in the same panel.

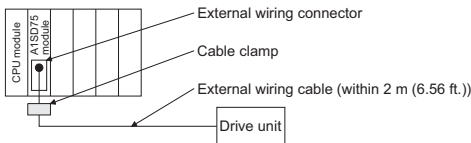

- (b) When wiring with cable that exceeds 2 m (6.56 ft.), but is 10 m (32.81 ft.) or less
- Ground the shield section of the external wiring cable with the cable clamp.  
(Ground the shield at the closest location to the A1SD75 external wiring connector.)
  - Install a ferrite core.
  - Wire the external wiring cable to the drive unit and external device with the shortest practicable length of cable.

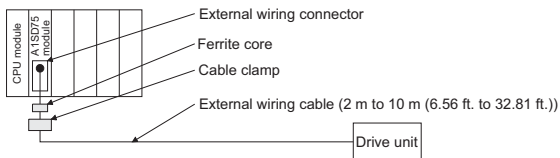

- (c) Ferrite core and cable clamp types and required quantities
- Cable clamp  
Type : AD75CK (manufactured by Mitsubishi Electric Corporation)
  - Ferrite core  
Type : ZCAT3035-1330 (manufactured by TDK Corporation)  
Contact: TDK Corporation
  - Required quantity

Cable length	Prepared part	Required Qty		
		1 axis	2 axes	3 axes
Within 2 m (6.56 ft.)	AD75CK	1	1	1
2 m (6.56 ft.) to 10m (32.81 ft.)	AD75CK	1	1	1
	ZCAT3035-1330	1	2	3

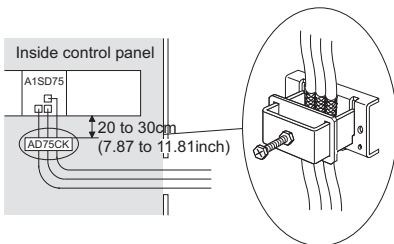

(6) CC-Link Module

- (a) Be sure to ground the cable shield that is connected to the CC-Link module close to the exit of control panel or to any of the CC-Link stations within 30 cm (11.81 in.) from the module or stations.

The CC-Link dedicated cable is a shielded cable. As shown in the illustration below, remove a portion of the outer covering and ground as large a surface area of the exposed shield part as possible.



- (b) Always use the specified CC-Link dedicated cable.
- (c) The CC-Link module, the CC-Link stations and the FG line inside the control panel should be connected at both the FG terminal and the SLD terminal as shown in the diagram below.

[Simplified diagram]

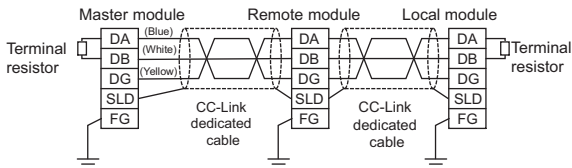

- (d) Each power line connecting to the external power supply terminal or module power supply terminal must be 30m (98.43 ft) or less.
- (e) Install a noise filter to the external power supply. Use a noise filter with an attenuation characteristic equivalent to that of the MA1206 (TDK-Lambda Corporation). Note that a noise filter is not required when the module is used in Zone A defined in EN61131-2.

- (f) Keep the length of signal cables connected to the analog input terminals of the following modules to 30m or less.  
Wire cables connected to the external power supply and module power supply terminal in the control panel where the module is installed.
- AJ65BT-64RD3
  - AJ65BT-64RD4
  - AJ65BT-68TD
- (g) For the cable connected to the power supply terminal of the AJ65SBT-RPS or AJ65BT-68TD, attach a ferrite core with an attenuation characteristic equivalent to that of the ZCAT3035-1330 from TDK Corporation. Twist the cable around the ferrite core by one as shown below.

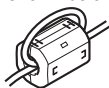

- (h) To supply the module power supply terminal of the AJ65BTB2-16R/16DR, AJ65SBTB2N-8A/8R/8S/16A/16R/16S with power using the AC/DC power supply, follow as shown below.
- Install the AC/DC power supply in the control panel where the module is installed.
  - Use a CE-marked AC/DC power supply and ground the FG terminals. (The AC/DC power supply used for the tests conducted by Mitsubishi: TDK-Lambda Corporation: DLP-120-24-1)
  - For the cable connected to the AC input terminal and DC output terminals of the AC/DC power supply, attach a ferrite core. Twist the cable around the ferrite core by one as shown below. (Ferrite core used for the tests conducted by Mitsubishi: NEC TOKIN Corporation: ESD-SR-250)

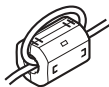



- (7) CC-Link/LT module  
To supply the CL2DA2-B and CL2AD4-B with 24VDC power using the CL1PAD1, keep the length of the power cable from the CL1PAD1 to the 24VDC power supply to 30m or less.
- (8) Measures against static electricity  
When using an insulation displacement connector without connector cover, a connected cable for the connector is thin in applicable wire size and coating. Therefore, note that the module may cause an electric discharge failure.  
As measures against the failure, using pressure-displacement type connector whose applicables wire size is thick or soldering type connector is recommended.

### 3.1.4 Power supply module

The precautions required for each power supply module are described below. Always observe the items noted as precautions.

Model	Precautions
A1S61PN, A1S62PN	Make sure to short the LG and FG terminals with a cable of 6 to 7cm and ground the cable.
A1S63P *1	Use the 24VDC panel power equipment conforming to the EU Directive.
A1SJHCPU(S8)	Make sure to short and ground the LG and FG terminals. *2

- \*1 Filter attachment to the power cable is not required for the A1S63P product with the version (F) and later. However, use the 24VDC panel power equipment that conforms to the CE.
- \*2 Make sure to attach two ferrite cores to the power line. Attach them as close to the power supply module as possible. Use a ferrite core whose damping characteristic is equivalent to that of the RFC-H13 produced by KITAGAWA INDUSTREIS CO., LTD.

### 3.1.5 Ferrite core

Use of ferrite cores is effective in reducing the conduction noise in the band of about 10 MHz and radiated noise in 30 to 100 MHz band. It is recommended to attach ferrite cores when the shield of the shielded cable coming out of the control panel does not work effectively, or when emission of the conduction noise from the power line has to be suppressed.

We tested using ferrite cores from TDK Corporation, ZCAT3035-1330 and ZCAT2032-0930, and RFC-H13 from KITAGAWA INDUSTREIS CO., LTD.

Make sure to attach a ferrite core to a cable at the position closest to the outlet of control panel as possible. If attached at an improper position, the ferrite core will not work effectively.

- Ferrite core

Type : ZCAT3035-1330, ZCAT2032-0930

Contact : TDK Corporation

Type : RFC-H13

Contact : KITAGAWA INDUSTREIS CO., LTD

### 3.1.6 Noise filter (power supply line filter)

A noise filter is a component which has an effect on conducted noise. With the exception of some models, it is not required to fit the noise filter to the power supply line, but fitting it can further suppress noise. (The noise filter has the effect of reducing conducted noise of 10 M Hz or less.) Use any of the following noise filters (double  $\pi$  type filters) or equivalent.

Model name	FN343-3/01	FN660-6/06	ZHC2203-11
Manufacturer	SCHAFFNER	SCHAFFNER	TDK
Rated current	3 A	6 A	3 A
Rated voltage	250 V		

The precautions required when installing a noise filter are described below.

- (1) Do not bundle the wires on the input side and output side of the noise filter. When bundled, the output side noise will be induced into the input side wires from which the noise was filtered.

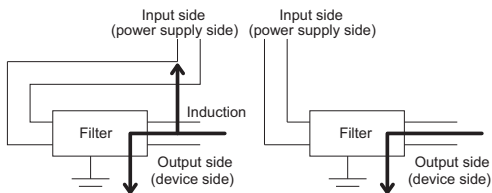

- (a) The noise will be included when the input and output wires are bundled.
  - (b) Separate and lay the input and output wires.
- (2) Earth the noise filter earthing terminal to the control cabinet with the shortest wire possible (approx. 10 cm (3.94 in.)).

### 3.1.7 Power line for external power supply terminal

Use a CE-marked AC/DC power supply for an external power supply of the modules, and the power cable length needs to be less than 30m (98.43 ft.).\*1

- \*1 The power cable length for the A1SJ71E71N-B5 needs to be less than 3m (9.84 ft.).

Install noise filters to external supply power terminals of the I/O module and the modules below.

Use noise filters whose damping characteristic is equivalent to that of the MA1206 produced by TDK Lambda Corporation.

- Analog-digital converter module
- Digital-analog converter module
- Analog I/O module
- Temperature input module
- Temperature control module
- Pulse input module
- High-speed counter module
- Positioning module

### **3.1.8 Installation environment of the CC-Link/LT module and the AS-i module**

#### (1) CC-Link/LT module

Use the module under the environment of Zone A\*1.

For the categories of the following products, refer to the manual came with each product.

- CL1Y4-R1B1
- CL1Y4-R1B2
- CL1XY4-DR1B2
- CL1XY8-DR1B2
- CL1PSU-2A

#### (2) AS-i module

Use the module under the environment of Zone A\*1.

\*1 Zone defines categories according to industrial environment, specified in the EMC and Low Voltage Directives, EN61131-2.

Zone C: Factory mains (isolated from public mains by dedicated transformer)

Zone B: Dedicated power distribution, secondary surge protection (rated voltage: 300V or less)

Zone A: Local power distribution, protected from dedicated power distribution by AC/DC converter and insulation transformer (rated voltage: 120V or less)

## **3.2 Requirements for Compliance with Low Voltage Directives**

The Low Voltage Directives apply to the electrical equipment operating from 50 to 1000VAC or 75 to 1500VDC; the manufacturer must ensure the adequate safety of the equipment.

Guidelines for installation and wiring of MELSEC-AnS series programmable controller are provided in Section 3.2.1 to 3.2.7 for the purpose of compliance with the EMC Directives.

The guidelines are created based on the requirements of the regulations and relevant standards, however, they do not guarantee that the machinery constructed according to them will comply with the Directives.

Therefore, the manufacturer of the machinery must finally determine how to make it comply with the EMC Directives: if it is actually compliant with the EMC Directives.

### **3.2.1 Standard applied for MELSEC-AnS series programmable controller**

The standard applied for MELSEC-AnS series programmable controller series is EN61010-1 safety of devices used in measurement rooms, control rooms, or laboratories.

For the modules which operate with the rated voltage of 50 VAC/75 VDC or above, we have developed new models that conform to the above standard.

For the modules which operate with the rated voltage under 50 VAC/75 VDC, the conventional models can be used, because they are out of the low voltage directive application range.

### 3.2.2 Precautions when using the MELSEC-AnS series programmable controller

#### Module selection

- (1) Power module  
For a power module with rated input voltage of 100/200 VAC, select a model in which the internal part between the first order and second order is intensively insulated, because it generates hazardous voltage (voltage of 42.4 V or more at the peak) area.  
For a power module with 24 VDC rated input, a conventional model can be used.
- (2) I/O module  
For I/O module with rated input voltage of 100/200 VAC, select a model in which the internal area between the first order and second order is intensively insulated, because it has hazardous voltage area.  
For I/O module with 24 VDC rated input, a conventional model can be used.
- (3) CPU module, memory cassette, base unit  
Conventional models can be used for these modules, because they only have a 5 VDC circuit inside.
- (4) Special function module  
Conventional models can be used for the special modules including analog module, network module, and positioning module, because the rated voltage is 24 VDC or smaller.
- (5) Display device  
Use the CE-marked product.

### 3.2.3 Power supply

The insulation specification of the power module was designed assuming installation category II. Be sure to use the installation category II power supply to the programmable controller.

The installation category indicates the durability level against surge voltage generated by a thunderbolt. Category I has the lowest durability; category IV has the highest durability.

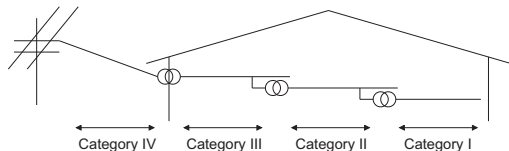

Figure 1.: Installation Category

Category II indicates a power supply whose voltage has been reduced by two or more levels of isolating transformers from the public power distribution.

### 3.2.4 Control panel

Because the programmable controller is an open device (a device designed to be stored within another module), be sure to use it after storing in the control panel.

#### (1) Electrical shock prevention

In order to prevent persons who are not familiar with the electric facility such as the operators from electric shocks, the control panel must have the following functions:

- (a) The control panel must be equipped with a lock so that only the personnel who has studied about the electric facility and have enough knowledge can open it.
- (b) The control panel must have a structure which automatically stops the power supply when the box is opened.
- (c) For electric shock protection, use IP20 or greater control panel.

(2) Dustproof and waterproof features

The control panel also has the dustproof and waterproof functions. Insufficient dustproof and waterproof features lower the insulation withstand voltage, resulting in insulation destruction. The insulation in our programmable controller is designed to cope with the pollution level 2, so use in an environment with pollution level 2 or below.

Pollution level 1: An environment where the air is dry and conductive dust does not exist.

Pollution level 2: An environment where conductive dust does not usually exist, but occasional temporary conductivity occurs due to the accumulated dust. Generally, this is the level for inside the control panel equivalent to IP54 in a control room or on the floor of a typical factory.

Pollution level 3: An environment where conductive dust exists and conductivity may be generated due to the accumulated dust.  
An environment for a typical factory floor.

Pollution level 4: Continuous conductivity may occur due to rain, snow, etc. An outdoor environment.

As shown above, the programmable controller can realize the pollution level 2 when stored in a control panel equivalent to IP54.



### 3.2.5 Module installation



- (1) Installing modules contiguously

In Q2AS series programmable controllers, the left side of each I/O module is left open. When installing an I/O module to the base, do not make any open slots between any two modules. If there is an open slot on the left side of a module with 100/200 VAC rating, the printed board which contains the hazardous voltage circuit becomes bare. When it is unavoidable to make an open slot, be sure to install the blank module (A1SG60).

### 3.2.6 Grounding

There are two kinds of grounding terminals as shown below. Either grounding terminal must be used grounded.

Be sure to ground the protective grounding for the safety reasons.

- Protective grounding  : Maintains the safety of the programmable controller and improves the noise resistance.
- Functional grounding  : Improves the noise resistance.

### 3.2.7 External wiring

- (1) Module power supply and external power supply

For the remote module which requires 24VDC as module power supply, the 5/12/24/48VDC I/O module, and the intelligent function module (special function module) which requires the external power supply, use the 5/12/24/48VDC circuit which is doubly insulated from the hazardous voltage circuit or use the power supply whose insulation is reinforced.

- (2) External devices

When a device with a hazardous voltage circuit is externally connected to the programmable controller, use a model whose circuit section of the interface to the programmable controller is intensively insulated from the hazardous voltage circuit.

- (3) Intensive insulation

Intensive insulation refers to the insulation with the dielectric withstand voltage shown in Table 1.

Table 1: Intensive Insulation Withstand Voltage  
(Installation Category II, source: IEC664)

Rated voltage of hazardous voltage area	Surge withstand voltage (1.2/50 $\mu$ s)
150 VAC or below	2500 V
300 VAC or below	4000 V

---

---

## 4. LOADING AND INSTALLATION

---

---

### 4.1 Installing the Module

#### 4.1.1 Notes on handling the module

This section explains some notes on handling the CPU module, I/O module, special function module, power supply module, and base unit.

- (1) Do not drop or allow any impact to the modules case, memory card, terminal block cover, or pin connector.
- (2) Do not remove the module printed wiring board from the case. Otherwise, a malfunction may occur.
- (3) Use caution to prevent foreign matter, such as wire chips, falling into the module during wiring. If foreign matter enters the module, remove it.
- (4) Use the following torque range to tighten the module fixing screws and terminal block screws:

Screw portion	Tightening torque range
Module fixing screw (M4 screw)	78 to 118 N·cm
I/O module (M3.5 screw)	59 to 88 N·cm
Power supply module terminal screws (M3.5 screw)	59 to 78 N·cm

- (4) *Appliquer le couple de serrage suivant lors du serrage des vis de fixation de module et des vis de borniers.*

Partie vissante	Plage de couple de serrage
Vis de fixation du module (vis M4)	78 à 118 N·cm
Module d'entrée/sortie (vis M3,5)	59 à 88 N·cm
Vis de borne du module d'alimentation (vis M3,5)	59 à 78 N·cm

- (5) Observe the following points when you are installing the DIN rail:
- (a) Applicable DIN rail type (JIS C 2812)  
TH35-7.5Fe  
TH35-7.5Al  
TH35-15Fe
  - (b) DIN rail installation screw interval  
When you are using the TH35-7.5Fe or TH35-7.5Al DIN rail, tighten the DIN rail installation screw with a pitch of 200 mm (7.87 inch) or less to maintain the strength.

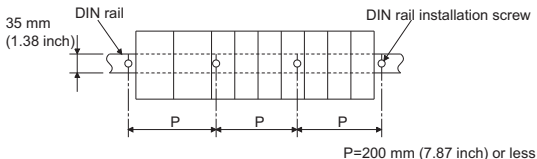

- (6) When installing the base unit to DIN rail in an environment with large vibration, use a vibration-proofing bracket (A1S-PLT-D). Mounting the vibration-proofing bracket (A1S-PLT-D) enhances the resistance to vibration. Depending on the environment to set up the base unit, it is also recommended to fix the base unit to the control panel directly.

### **4.1.2 Installation environment**

Avoid the following environment when you install the CPU system:

- (1) A location in which the ambient temperature falls outside the range of 0 to 55 degrees Celsius.
- (2) A location in which the ambient humidity falls outside the range of 10 to 90%RH.
- (3) A location in which condensation may occur due to drastic changes in temperature.
- (4) A location in which corrosive gas or flammable gas exists.
- (5) A location in which the system is easily exposed to conductive powder, such as dust and iron filings, oil mist, salt, or organic solvent.
- (6) A location exposed to direct sunlight.
- (7) A location in which strong electrical or magnetic fields are generated.
- (8) A location in which the module is exposed to direct vibration or impact.

### 4.1.3 Notes on installing the base unit

Take ease of operation, ease of maintenance, and environmental durability into consideration when you are installing the programmable controller on the panel.

(1) Mounting dimension

Mounting dimensions of each base unit are as follows:

(a) Main base unit

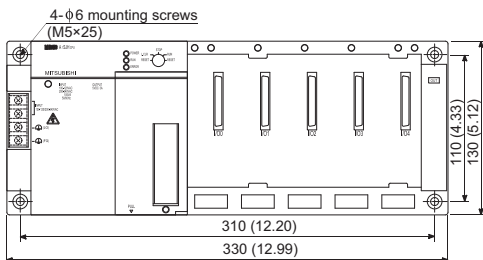

(b) External base unit

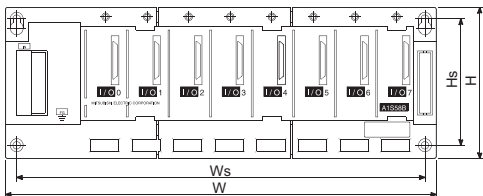

Dimensions: mm (inch)

	A1S52B (S1)	A1S55B (S1)	A1S58B (S1)	A1S65B (S1)	A1S68B (S1)
W	155 (6.10)	260 (10.24)	365 (14.37)	315 (12.40)	420 (16.54)
Ws	135 (5.31)	240 (9.45)	345 (13.58)	295 (11.61)	400 (15.75)
H	130 (5.12)				
Hs	110 (4.33)				

## (2) Module installation position

To maintain good ventilation and make it easy to replace the module, keep the following distances between the top and bottom of the module and the structure or other components.

- A1SJHCPU, A1S5□B, A1S6□B .....30 mm (1.18 inch) or over
- A5□B, A6□B .....80 mm (3.15 inch) or over

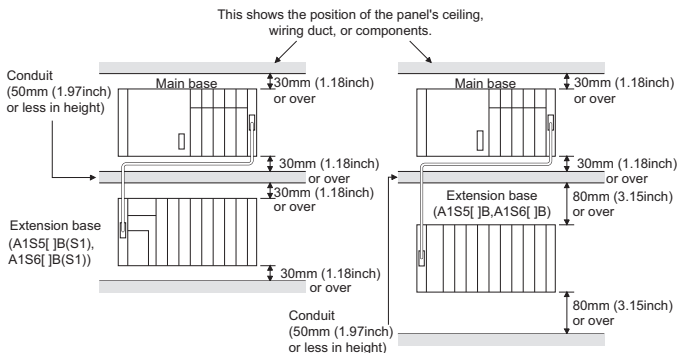

## (3) Module installation direction

- (a) Use the programmable controller in the following position for better ventilation and heat dissipation:

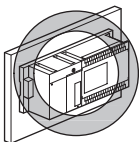

- (b) Do not use the programmable controller in the following positions:

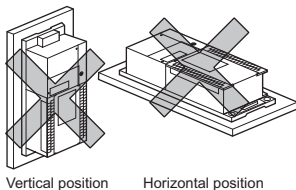

- (4) Install the base unit on a level surface.  
If the surface is not level, force may be applied to the printed wiring board, causing a malfunction.
- (5) Install the unit far from any source of vibration, such as a large magnetic contactor and a no-fuse breaker on the same panel, or install it on a separate panel.
- (6) Keep the following distance between the programmable controller and other devices (such as a contactor and a relay) in order to avoid the influence of radiated noise and heat:
- a device installed in front of the programmable controller .....100mm (3.94 inch) or more
  - a device installed on the right or left of the programmable controller.....50mm (1.97 inch) or more

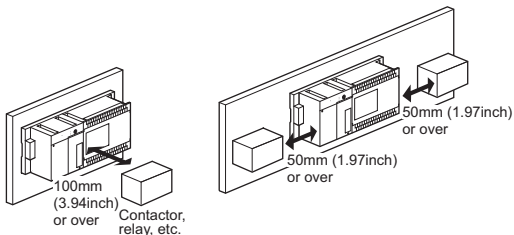

## 4.2 Fail-Safe Circuit Concept

When the programmable controller is powered ON and then OFF, improper outputs may be generated temporarily depending on the delay time and start-up time differences between the programmable controller power supply and the external power supply for the control target (especially, DC).

For example, if the external power supply for the control target is powered ON and then the programmable controller is powered ON, the DC output module may generate incorrect outputs temporarily upon the programmable controller power-ON. Therefore, it is required to build the circuit that energizes the programmable controller by priority.

The external power failure or programmable controller failure may lead to the system error.

In order to eliminate the possibility of the system error and ensure fail-safe operation, build the following circuit outside the programmable controller: emergency circuit, protection circuit and interlock circuit, as they could cause machine damages and accidents due to the abovementioned failures.

An example of system design, which is based on fail-safe concept, is provided on the next page.



# (1) System design circuit example

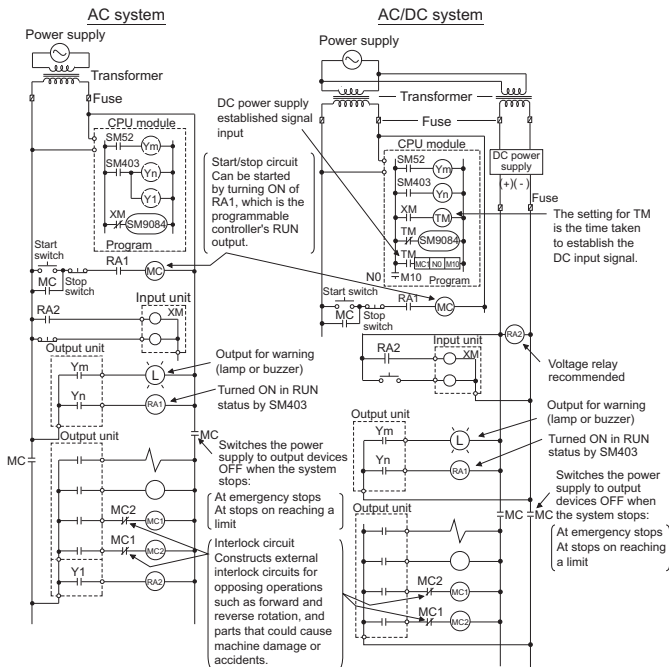

The procedures used to switch on the power supply are indicated below.

AC system

- [1] Switch the power supply ON.
- [2] Set the CPU module to RUN.
- [3] Switch the start switch ON.
- [4] The output devices are driven in accordance with program when the magnetic contactor (MC) turns ON.

AC/DC system

- [1] Switch the power supply ON.
- [2] Set the CPU module to RUN.
- [3] Switch RA2 ON when the DC power supply starts.
- [4] Switch the timer (TM) ON when the DC power supply reaches working voltage. (The set value for TM must be the time it takes for 100% establishment of the DC power after RA2 is switched ON. Make this set value 0.5 seconds.)
- [5] Switch the start switch ON.
- [6] The output devices are driven in accordance with the program when the magnetic contactor (MC) comes ON.  
(If a voltage relay is used at RA2, no timer (TM) is necessary in the program.)

(2) Fail-safe measures to cover the possibility of programmable controller failure

Problems with a CPU module and memory can be detected by the self diagnostics function. However, problems with I/O control area may not be detected by the CPU module.

In such cases, all I/O points turn ON or OFF depending on the problem, and normal operation and safety cannot be maintained. Though Mitsubishi programmable controllers are manufactured under strict quality control, they may fail or malfunction due to unspecified reasons. To prevent the whole system failure, machine breakdown, and accidents, build a fail-safe circuit outside the programmable controller.

Examples of a system and its fail-safe circuitry are described below:

<System example>

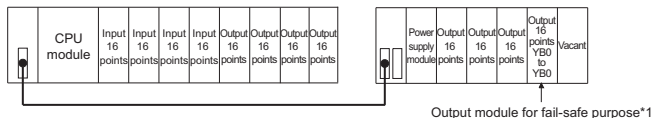

- \*1 The output module for fail-safe purpose should be mounted on the last slot of the system. (YB0 to YBF in the above system.)

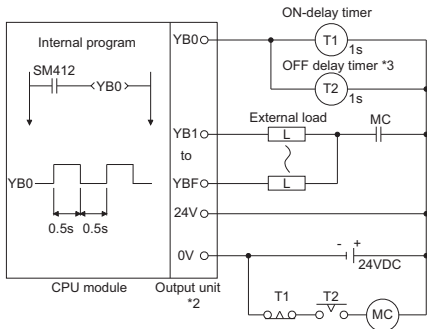

- \*2 Since YB0 turns ON and OFF alternatively at 0.5 second intervals, use a contactless output module (a transistor is used in the above example).
- \*3 If an offdelay timer (especially miniature timer) is not available, construct the failsafe circuit using an ondelay timer shown on the next page.

## When constructing a failsafe circuit using ondelay timers only

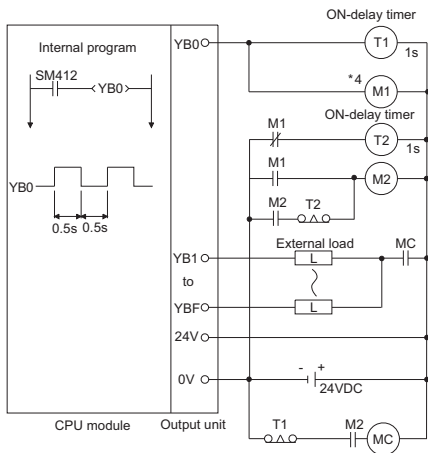

\*4 Use a solid state relay for the M1 relay.

## 4.3 Wiring

### 4.3.1 Performance specifications for the A1SJHCPU built-in power supply

Table 4.1 Performance specifications for the A1SJHCPU built -in power supply

Item	Type	A1SJHCPU
Input power supply	100 to 120VAC	+10% (85 to 132VAC) -15%
	200 to 240VAC	+10% (170 to 264VAC) -15%
Input frequency	50/60Hz $\pm$ 3Hz	
Input voltage distortion factor	Within 5% (Refer to Section 4.3.)	
Input maximum apparent power	100VA	
Inrush current	20A 8ms or less	
Rated output	5 VDC 3A	
Overcurrent protection *1	3.3A or over	
Overvoltage protection *2	Not provided	
Efficiency	65 % or over	
Power supply indication	POWER LED indicator	
Terminal screw size	M3.5 $\times$ 8	
<i>Taille des vis de borne</i>	<i>M3.5 <math>\times</math> 8</i>	
Applicable wire size	0.3 to 2 mm <sup>2</sup>	
<i>Taille du fil à utiliser</i>	<i>0,3 à 2 mm<sup>2</sup></i>	
Applicable solderless terminal	RAV 1.25 to 3.5, RAV 2 to 3.5	
<i>Borne sans soudure à utiliser</i>	<i>RAV 1,25 à 3,5, RAV 2 à 3,5</i>	
Allowable momentary power failure period *3	20ms or less (100VAC or over)	

POINT
*1 Overcurrent protection The overcurrent protection device shuts off the 5VDC and/or 24VDC circuit(s) and stops the system if the current exceeding the specified value flows in the circuit(s). As this results in voltage drop, the power supply module LED turns OFF or is dimly lit. After that, eliminate the causes of overcurrent, e.g., insufficient current capacity and short circuit, and then start the system. When the current has reached the normal value, the initial start up of the system will be performed.
*2 Overvoltage protection The overvoltage protection shuts off the 5VDC circuit and stops the system if the overvoltage of 5.5 to 6.5V is applied to the circuit. This results in the power supply module LED turning OFF. When restarting the system, power OFF and ON the input power supply, and the initial start up of the system will be performed. If the system is not booted and the LED remains off, this means that the power supply module has to be replaced.
*3 Allowable momentary power failure period The programmable controller CPU allowable momentary power failure period varies with the power supply module used. In case of the A1S63P power supply module, the allowable momentary power failure period is defined as the time from when the primary side of the stabilized power supply for supplying 24VDC to the A1S63P is turned OFF until when the voltage (secondary side) has dropped from 24VDC to the specified value (15.6VDC) or less.
*4 Inrush current If the power supply module is re-powered ON right after powered OFF (within 5s), the inrush current exceeding the specified value (2ms or less) may be generated. Therefore, make sure to re-power ON the module 5s after power off. When selecting a fuse or breaker for external circuit, consider the above point as well as meltdown and detection characteristics.

### 4.3.2 The precautions on the wirings

This section gives the wiring instruction for the system.

#### (1) Wiring of power supply

- (a) When voltage fluctuations are larger than the specified value, connect a constant-voltage transformer.



- (b) Use a power supply which generates minimal noise between wires and between the programmable controller and ground. If excessive noise is generated, connect an insulating transformer.



- (c) When a power transformer or insulating transformer is employed to reduce the voltage from 200 VAC to 100 VAC, use one with a capacity greater than those indicated in the following table.

Power Supply Module	Transformer Capacity
A1S61PN	110VA × n
A1S62PN	110VA × n

n: Stands for the number of power supply modules.

- (d) Separate the programmable controller's power supply line from the lines for I/O devices and power devices as shown below.  
When there is much noise, connect an insulation transformer.
- (e) Taking rated current or inrush current into consideration when wiring the power supply, be sure to connect a breaker or an external fuse that have proper blown and detection.  
When using a single programmable controller, a 10A breaker or an external fuse are recommended for wiring protection.

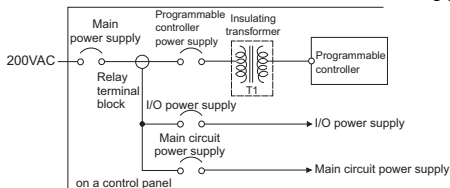

- (f) Note on using the 24 VDC output of the A1S62PN power supply module.

If the 24 VDC output capacity is insufficient for one power supply module, supply 24 VDC from the external 24 VDC power supply as shown below:

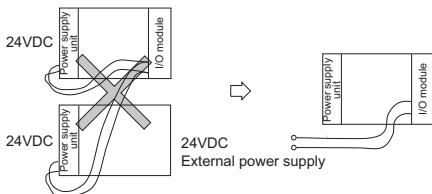

- (g) 100 V AC, 200 V AC and 24 V DC wires should be twisted as dense as possible. Connect the modules with the shortest distance.

Also, to reduce the voltage drop to the minimum, use the thickest wires possible (maximum  $2\text{mm}^2$ ).

- (h) Do not bind 100VAC and 24VDC wires together with main circuit (high tension and large current) wires or I/O signal lines (including common line) nor place them near each other. Provide 100mm (3.94 inch) clearance between the wires if possible.
- (i) As a countermeasure to power surge due to lightning, connect a surge absorber for lightning as shown below.

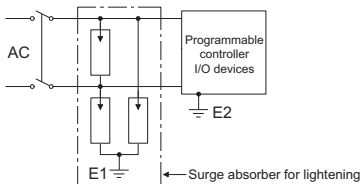

#### POINT

- (1) Separate the ground of the surge absorber for lightning (E1) from that of the programmable controller (E2).
- (2) Select a surge absorber for lightning whose power supply voltage does not exceed the maximum allowable circuit voltage even at the time of maximum power supply voltage elevation.



(2) Wiring to I/O device

- (a) The solderless terminal with insulation sleeve is inapplicable to a terminal block.  
It is advisable to cover the wire connection part of a terminal with a mark tube or insulation tube.
- (b) Install wiring to a terminal block using the cable of core diameter 0.3 to 0.75mm<sup>2</sup>, and outside diameter 2.8mm or less.
- (c) Run the I/O line and output line away from each other.
- (d) When the main circuit line and power line cannot be separated, use a shielding cable and ground it on the programmable controller side.  
However, ground it on the opposite side in some cases.

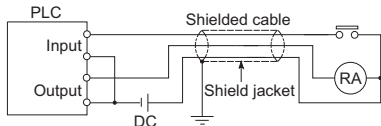

- (e) When cables are run through pipes, securely ground the pipes.
- (f) Run the 24VDC input line away from the 100VAC and 200 VAC lines.
- (g) The cabling of 200m (656.2ft.) or longer distance may produce leakage current depending on the capacity between lines and result in an accident.
- (h) As a countermeasure against the power surge due to lightning, separate the AC wiring and DC wiring and connect a surge absorber for lightning as shown in (i) of item (1).  
Failure to do so increases the risk of I/O device failure due to lightning.

### (3) Grounding

- (a) Carry out the independent grounding if possible. (Grounding resistance 100Ω or less.)
- (b) If the independent grounding is impossible, carry out the shared grounding (2) as shown below.

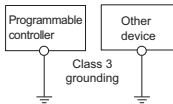

(1) Independent grounding.....Best

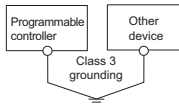

(2) Shared grounding.....Good

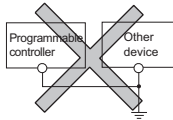

(3) Common grounding.....Not allowed

- (c) Use the cable of 2mm<sup>2</sup> or more for grounding.  
Set the grounding point closer to the programmable controller to make the grounding cable short as possible.
- (d) If a malfunction occurs due to earthing, separate either LG or FG of the base module, the device combination, or all the connection from the earthing.

### 4.3.3 Wiring to module terminals

#### *Câblage aux bornes du module*

This section explains the wiring of power lines and grounding lines to the main and extension bases.

*Cette section traite du câblage des lignes d'alimentation et des lignes de mise à la terre sur la base principale et la base d'extension.*

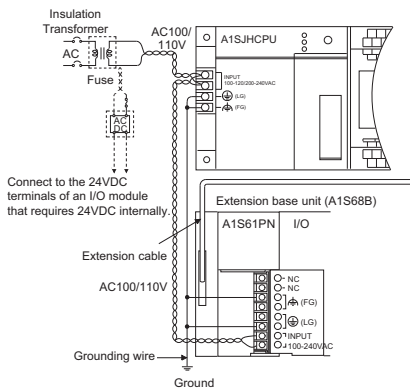

English	French
Connect to the 24VDC terminals of an I/O module that requires 24VDC internally.	<i>Raccorder aux bornes 24 V cc d'un module E/S pour lequel il faut une alimentation interne 24 V cc.</i>
Extension base unit	<i>Unité de base d'extension</i>
Extension cable	<i>Câble de rallonge</i>
Fuse	<i>Fusible</i>
Ground	<i>Terre</i>
Grounding wire	<i>Fil de terre</i>
Insulation Transformer	<i>Isolation Transformer</i>

POINT

- (1) Use the thickest possible (max. 2 mm<sup>2</sup> (14 AWG)) wires for the 100/200 VAC and 24 VDC power cables. Be sure to twist these wires starting at the connection terminals. For wiring a terminal block, be sure to use a solderless terminal. To prevent short-circuit due to loosening screws, use the solderless terminals with insulation sleeves of 0.8 mm (0.03 inch) or less thick. The number of the solderless terminals to be connected for one terminal block are limited to 2.

*Pour les câbles d'alimentation 100/200 V ca et 24 V cc, utiliser la plus grosse taille de fil possible (2 mm<sup>2</sup> (14 AWG) au maximum). Torsader ces fils les uns avec les autres en commençant vers les bornes de raccordement. Pour le câblage sur bornier, toujours utiliser des bornes sans soudure. Pour éviter les court-circuits en cas de desserrement des vis, utiliser des bornes sans soudure avec manchons isolants d'une épaisseur maximum de 0,8 mm (0,03 pouce). Le nombre de bornes sans soudure à raccorder sur une seule plaque à bornes est limité à 2.*



- (2) Be sure to ground the LG and FG terminals. Failure to do so may cause the programmable controller to be susceptible to noise. Note that LG terminals include the potential as half as that of input voltage; you might get an electric shock when you touch them.

*Il est indispensable de mettre les bornes LG et FG à la terre. Faute de quoi, l'automate programmable risque d'être affecté par des phénomènes d'interférences. Noter que, même s'il n'est que la moitié de la tension d'entrée, le potentiel aux bornes LG peut infliger un choc électrique.*

## 4.4 Precautions when Connecting the Uninterruptible Power Supply (UPS)

Connect the A1SJHCPU system to the uninterruptible power supply (UPS), while paying attention to the followings.

When connecting an uninterruptible power supply (UPS) to the programmable controller system, use an online UPS or line-interactive UPS with a voltage distortion rate of 5% or less.

When connecting a standby UPS, use a Mitsubishi FREQUPS FW-F series UPS (hereinafter FW-F series UPS)\*1. (Example: FW-F10-0.3K/0.5K)

Do not use any standby UPS other than the FW-F series UPS.

- \*1 The FW-F series UPS whose serial number starts with the letter "P" or later, or ends with the letters "HE" is applicable.

SERIAL : 000000000  
└──────────────────┘ Starts with "P" or later

SERIAL : B00000000    HE  
                          └──┘ Ends with "HE"

## 4.5 Parts of the CPU

Parts of A1SJHCPU are described below.  
A1SJHCPU

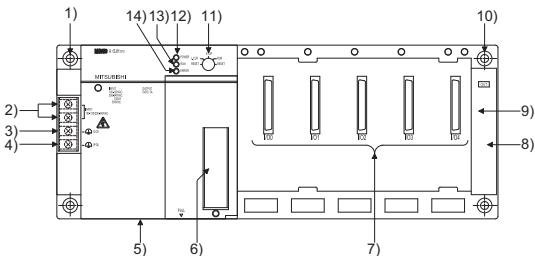

- 1) Base mounting hole
- 2) Power supply input terminal
- 3) LG terminal
- 4) FG terminal
- 5) Hook for DIN rail
- 6) Cover for RS-422 connector
- 7) Module connector
- 8) Connector for extension cable
- 9) Base cover
- 10) Module fixing screw
- 11) RUN/STOP switch

RUN/STOP key switch:

Used to start or stop sequence program execution.

RESET switch:

Used to reset the hardware.

Used to reset the hardware and initialize operation when an operation error occurs.

L.CLR:

Used to clear the data set in the latch range set in the parameters.

- 12) "POWER" LED

(Indicator LED for the 5 VDC power supply.)

### 13) "RUN" LED

ON:

Indicates that the RUN/STOP key switch is set to the RUN position and the sequence program is being executed.

OFF:

The "RUN" LED is OFF in the following cases:

- When the 100/200 VAC power supply is not being supplied to the A1SJHCPU.
- When the RUN/STOP key switch is set to the STOP position.
- When a remote STOP/ PAUSE is currently effective.

Flashing:

The "RUN" LED flashes in the following cases:

- When an error that stops sequence program operation has been detected in self-diagnosis.
- When a latch clear operation is being executed.

### 14) ERROR LED

ON:

Indicates that an error has been detected in self-diagnosis (Note that this LED remains OFF if the setting for the detected error in the ERROR LED indication priority settings is "OFF".)

OFF:

Indicates that no error has occurred, or a fault has been detected by the CHK instruction.

Flashing:

Indicates that the annunciator (F) has been switched ON by the sequence program.

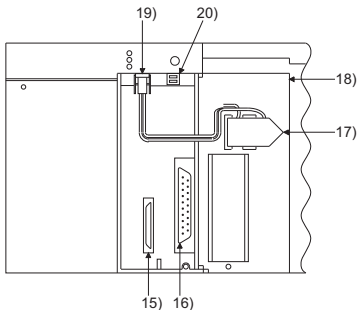

- 15) Connector for installing the memory cassette
- 16) RS-422 connector
- 17) Battery
- 18) Cover
- 19) Battery connector
- 20) Dip switch

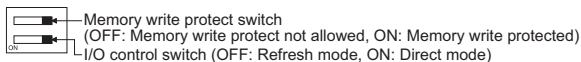

#### Method for clearing the latch status

- 1) Set the RUN/STOP switch from the STOP position to the L.CLR position several times, causing the RUN LED to flash.
- 2) Set the RUN/STOP switch from the STOP position to the L.CLR position one more time.
- 3) The latch clear operation is completed when the RUN LED goes OFF.





## 5. SPECIFICATION AND CONNECTION OF I/O MODULES

### 5.1 Input modules

#### 5.1.1 Input module specifications

Model	Type	No. of Points	Rated Input Voltage	Input Current	Operating Voltage			
					ON voltage	OFF voltage		
A1SX10	AC input	16	100 to 120VAC	6mA	80VAC or higher	30VAC or lower		
A1SX10EU				7mA				
A1SX20				200 to 240VAC			9mA	
A1SX20EU							11mA	
A1SX30	DC/AC input		12/24VDC	4.2/ 8.6mA	7VDC/AC or higher	2.7VDC/AC or lower		
			12/24VAC					
A1SX40			12/24VDC	3/7mA	8VDC or higher	4VDC or lower		
A1SX40-S1			24VDC	7mA	14VDC or higher	6.5VDC or lower		
A1SX40-S2								
A1SX41	DC input (sink type)		32	12/24VDC	3/7mA	8VDC or higher	4VDC or lower	
A1SX41-S1				24VDC	7mA	17VDC or higher	3.5VDC or lower	
A1SX41-S2			14VDC or higher			6.5VDC or lower		
A1SX42			64	12/24VDC	2/5mA	8VDC or higher	4VDC or lower	
A1SX42-S1	24VDC			5mA	18.5VDC or higher	3VDC or lower		
A1SX42-S2					17.5VDC or higher	7VDC or lower		

	Maximum Simultaneous Input Points (Percentage Simultaneously ON)	Max. Response Time		Field Wiring	Points/ Common	Internal Current Consumption (5VDC)	No. of Occupied Points					
		OFF to ON	ON to OFF									
	100%(110VAC) 60%(132VAC)	20ms or lower	35ms or lower	Terminal	16	0.05A	16					
	100%(110VAC)											
	60%(220VAC)											
	75%(26.4VDC)	20ms or lower	20ms or lower									
		25ms or lower	20ms or lower									
	100%(26.4VDC)	10ms or lower	10ms or lower	40-pin connector	32	0.08A	32					
			0.1ms or lower					0.2ms or lower				
	60%(26.4VDC)	10ms or lower	10ms or lower					40-pin connector	32	0.12A	64	
			0.3ms or lower									0.3ms or lower
			10ms or lower									10ms or lower
	50%(24VDC)	0.3ms or lower	0.3ms or lower	40-pin connector ×2	32	0.09A	64					
			0.3ms or lower					0.3ms or lower				
			10ms or lower					10ms or lower				

Model	Type	No. of Points	Rated Input Voltage	Input Current	Operating Voltage		
					ON voltage	OFF voltage	
A1SX71	DC input (sink/source type)	32	5/12/24VDC	1.2/3.3/7mA	3.5VDC or higher	1VDC or lower	
A1SX80		16	12/24VDC	3/7mA	8VDC or higher	4VDC or lower	
A1SX80-S1			24VDC	7mA	17VDC or higher	5VDC or lower	
A1SX80-S2			24VDC		13VDC or higher	6VDC or lower	
A1SX81			32	12/24VDC	3/7mA	8VDC or higher	4VDC or lower
A1SX81-S2		24VDC		7mA	13VDC or higher	6VDC or lower	
A1SX82-S1		64	24VDC	5mA	18.5VDC or higher	3VDC or lower	
A1S42X		DC input (dynamic)	*2 16/32 48/64	12/24VDC	4/9mA	8VDC or higher	4VDC or lower

	Maximum Simultaneous Input Points (Percentage Simultaneously ON)	Max. Response Time		Field Wiring	Points/ Common	Internal Current Consumption (5VDC)	No. of Occupied Points
		OFF to ON	ON to OFF				
	65%(24VDC)	1.5ms or lower	3ms or lower	40-pin connector	32	0.075A	32
	100%(26.4VDC)	10ms or lower	10ms or lower	Terminal	16	0.05A	16
	85%(26.4VDC)	0.4ms or lower	0.5ms or lower				
	100%(26.4VDC)	10ms or lower	10ms or lower				
	60%(26.4VDC)	10ms or lower	10ms or lower	37-pin D-sub connector	32	0.08A	32
	50%(26.4VDC)	0.3ms or lower	0.3ms or lower	40-pin connector x2	32	0.16A	64
	100%(26.4VDC)	0.4ms or lower*1	0.4ms or lower*1	24-pin connector	-	0.08A	16/32/48/64

For all modules, the insulation system is photocoupler insulation and the input indications are LED indications.

\*1 The dynamic scan cycle is 13.3ms.

\*2 Set using the DIP switch on the module front.

## 5.1.2 Input module connections

### Raccordements du module d'entrée

(1)	Model	Rated Input Voltage
	A1SX10	100 to 120 VAC
	A1SX10EU	
	A1SX20	200 to 240 VAC
A1SX20EU		

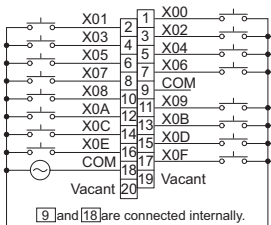

**WARNING**

• Do not touch any terminal during power distribution. Doing so may cause an electric shock or malfunctions.

(2)	Model	Rated Input Voltage
	A1SX30	12/24 VAC/DC

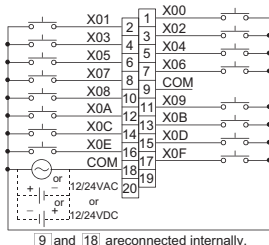

(3)	Model	Rated Input Voltage
	A1SX40	12/24 VAC
	A1SX40-S1	24 VAC
	A1SX40-S2	

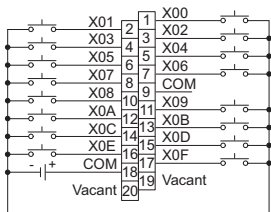

(4)	Model	Rated Input Voltage
	A1SX80	12/24 VAC
	A1SX80-S1	24 VAC
	A1SX80-S2	

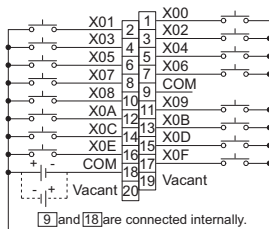

	Model	Rated Input Voltage
(5)	A1SX41	12/24 VDC
	A1SX41-S1(S2)	24 VDC
	A1SX42* <sup>1</sup>	12/24 VDC
	A1SX42-S1* <sup>1</sup> (S2)	24 VDC
	A1SX82-S1* <sup>3</sup>	

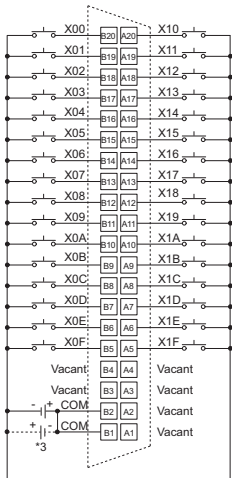

\*1 The figure above indicates **[F]** (the first half 32 points).

The connections for **[L]** (the latter half 32 points) are the same as for **[F]** (regard X00 to X1F as X20 to X3F.)

**[B1]** and **[B2]** are connected internally.

\*2 The A and B pin number rows shown above are transposed with respect to the diagram of the A and B rows which is printed on the module. Remember that the A row pin numbers correspond to the B row of the module.

\*3 A1SX82-S1 can use both positive common and negative common.

	Model	Rated Input Voltage
(6)	A1SX71	5/12/24 VDC

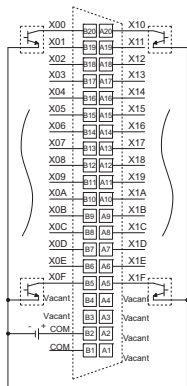

\*1 The figure above shows the connections for the open collector (sink) type.

**[B1]** and **[B2]** are connected internally.

● TTL, LS-TTL, CMOS buffer (sink) connection

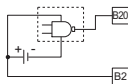

● Sensor (source) connection

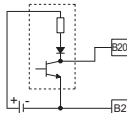

\*2 The A and B pin number rows shown above are transposed with respect to the diagram of the A and B rows which is printed on the module. Remember that the A row pin numbers correspond to the B row of the module.

(7)	Model	Rated Input Voltage
	A1SX81	12/24 VDC
	A1SX81-S2	24 VDC

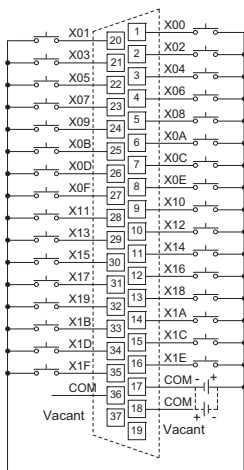

● [17], and [18] and [36] are connected internally.



(8)	Model	Rated Input Voltage
	A1S42X	12/24 VDC

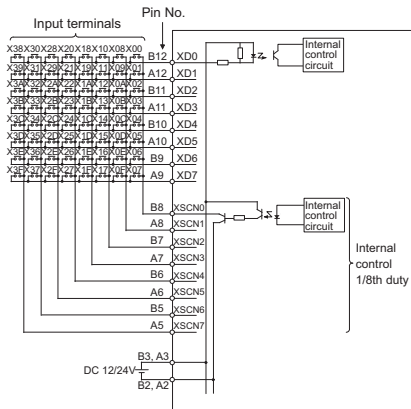

\* If there will be cases where two or more switches are pressed simultaneously, install a diode at each switch (see right).



### Pin Arrangement

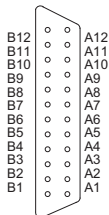

Seen from front face of the module

Pin No.	Signal Name	Pin No.	Signal Name
B12	XD0	A12	XD1
B11	XD2	A11	XD3
B10	XD4	A10	XD5
B9	XD6	A9	XD7
B8	XSCN0	A8	XSCN1
B7	XSCN2	A7	XSCN3
B6	XSCN4	A6	XSCN5
B5	XSCN6	A5	XSCN7
B4	Vacant	A4	Vacant
B3	12/24 VDC	A3	12/24 VDC
B2	0V	A2	0V
B1	FG	A1	FG

English	French
[17], and [18] and [36] are connected internally.	[17], [18] et [36] sont connectés à l'intérieur.
[61] and [62] are connected internally.	[61] et [62] sont connectés à l'intérieur.
12/24 VDC	12/24 V cc
24 VDC	24 V cc
5/12/24 VDC	5/12/24 V cc
A1SX82-S1 can use both positive common and negative common.	A1SX82-S1 peut s'utiliser avec commun en positif ou commun en négatif.
If there will be cases where two or more switches are pressed simultaneously, install a diode at each switch (see right).	Dans le cas où deux contacteurs ou plus sont actionnés simultanément, installer une diode pour chaque contacteur (voir ci-contre à droite).
Input terminals	Bornes d'entrée
Internal control 1/8th duty	Commande interne facteur d'utilisation 1/8ème
Internal control circuit	Circuit de commande interne
Model	Modèle
Pin Arrangement	Attribution des broches
Pin No.	Broche N°
Rated Input Voltage	Tension nominale d'entrée
Remember that the A row pin numbers correspond to the B row of the module.	Noter que les numéros de broche de rangée A correspondent à la rangée B sur le module.
Seen from front face of the module	Vu depuis le devant du module
Sensor (source) connection	Connexion capteur (source)
Signal Name	Nom de signal
The A and B pin number rows shown above are transposed with respect to the diagram of the A and B rows which is printed on the module.	Les rangées de broches A et B ci-dessous correspondent aux rangées de broches marquées A et B sur le schéma imprimé sur le module.
The connections for [L] (the latter half 32 points) are the same as for [F] (regard X00 to X1F as X20 to X3F.)	Les connexions pour [L] (deuxième moitié de 32 points) sont comme pour [F] (considérer X00 à X1F comme état X20 à X3F.)
The figure above indicates [F] (the first half 32 points).	La figure ci-dessus représente [F] (première moitié de 32 points).
The figure above shows the connections for the open collector (sink) type.	La figure ci-dessus représente les connexions pour le type collecteur ouvert (dissipateur).
TTL, LS-TTL, CMOS buffer (sink) connection	TTL, LS-TTL, connexion tampon CMOS (dissipateur)
Vacant	Libre



## 5.2 Output modules

### 5.2.1 Output module specifications

Model	Type	No. of Points	Rated Load Voltage	Max. Load Current			Max. Output Response Time	
				Point	Common	Module	OFF to ON	ON to OFF
A1SY10	Relay Output	16	100V to 240VAC 24VDC	2A	8A	-	10ms or lower	12ms or lower
A1SY 10EU			100V to 120VAC 24VDC			-		
A1SY 14EU			100V to 240VAC 24VDC			-		
A1SY 18A		-			-			
A1SY 18AEU		8	-		-			
A1SY22	Triac Output	16	100V to 240VAC	0.6A	2.4A	-	1ms or lower	1ms + 0.5 cycles or less
A1SY 28A		8		1A	-	8A(AC1 32V, 46°C), 8A(AC2 64V, 40°C) 4A(AC1 32V, 55°C), 2A(AC2 64V, 55°C)		
A1SY 28EU				0.6A	2.4A (46°C) 1.9A (55°C)	-		

For all modules, the insulation system is photocoupler insulation and the output indications are LED indications.

\*1 The dynamic scan cycle is 13.3ms (FAST mode) or 106.7ms (SLOW mode).  
(Set using the DIP setting on the module rear.)

\*2 Set using the DIP switch on the module front.

Field Wiring	Points/ Common	Surge Suppression	Fuse Rating	Error display	External Power Supply (TYP DC24V)		Internal Current Consumption	No. of Occupied Points
					Current			
Terminal	8	None	None	None		0.090A	0.12A	16
	4					0.1A	0.12A	
	-					0.075A	0.24A	
	-					0.075A	0.24A	
	8	CR absorber	5A	LED*5	0.002A*3	0.27A		
	-	CR absorber varistor	None	None	-	0.13A		
	4	CR absorber				0.27A		

\*3 Value at TYP 200VAC.

\*4 Value at TYP 12VDC.

\*5 "ERR." LED turns on when fuse is blown or external supply power is off.

\*6 0.08A is shown on the rating plate of the module.

\*7 0.15A is shown on the rating plate of the module.

Model	Type	No. of Points	Rated Load Voltage	Max. Load Current			Max. Output Response Time	
				Point	Common	Module	OFF to ON	ON to OFF
A1SY40	Transistor Output (sink type)	16	12/24V DC	0.1A	0.8A	-	2ms or lower	2ms or lower
A1SY40P						-	1ms or lower	1ms or lower
A1SY41		32			2A	-	2ms or lower	2ms or lower
A1SY41P						-	1ms or lower	1ms or lower
A1SY42		64			1.6A	-	2ms or lower	2ms or lower
A1SY42P						-	1ms or lower	1ms or lower
A1SY50		16			2A	-	2ms or lower	2ms or lower
A1SY60	24VDC		2A (25°C) 1.8A (45°C) 1.6A (55°C)	4A (25°C) 3.6A (45°C) 3.2A (55°C)		-		
A1SY60E	Transistor Output (source type)	5/12 /24VDC	2A	4A	-	3ms or lower	10ms or lower	
A1SY68A	Transistor Output (sink/source type)	8	5/12 24/ 48VDC	2A	-			
A1SY71	Transistor Output (for TTL/ CMOS) sink type	32	5/ 12VDC	0.016A	0.256A	-	1ms or lower	1ms or lower

For all modules, the insulation system is photocoupler insulation and the output indications are LED indications.

\*1 The dynamic scan cycle is 13.3ms (FAST mode) or 106.7ms (SLOW mode).  
(Set using the DIP switch on the module rear.)

\*2 Set using the DIP switch on the module front.

	Field Wiring	Points/ Common	Surge Suppression	Fuse Rating	Error display	External Power Supply (TYP DC24V)	Internal Current Consumption	No. of Occupied Points
						Current		
	Terminal	8	Zener diode	1.6A	LED*5	0.008A	0.27A	16
				None	None	0.011A	0.079A*6	
	40-pin connector	32		3.2A	LED*5	0.008A	0.5A	32
				None	None	0.012A	0.141A*7	
	40-pin connector ×2			3.2A	LED*5	0.008A	0.93A	64
				None	None	0.014A	0.17A	
	Terminal	8		3.2A	LED*5	0.06A	0.12A	16
				5A		0.015A	0.12A	
				7A		0.01A	0.2A	
				None		None	-	
		-						
40-pin connector	32	None	1.6A	LED*5	0.15A *4	0.4A	32	

\*3 Value at TYP 200VAC.

\*4 Value at TYP 12VDC.

\*5 "ERR." LED turns on when fuse is blown or external supply power is off.

\*6 0.08A is shown on the rating plate of the module.

\*7 0.15A is shown on the rating plate of the module.

Model	Type	No. of Points	Rated Load Voltage	Max. Load Current			Max. Output Response Time	
				Point	Common	Module	OFF to ON	ON to OFF
A1SY80	Transistor Output (source type)	16	12/24V DC	0.8A	3.2A	-	2ms or lower	2ms or lower
A1SY81				0.1A	2A	-	2ms or lower	2ms or lower
A1SY81EP		32		0.1A (25°C), 0.05A (55°C)	2A (25°C), 1.6A (55°C)	-	0.5ms or lower	1.5ms or lower
A1SY82		64		0.1A	1.6A	-	2ms or lower	2ms or lower
A1S42Y		Transistor Output (dynamic)		16/32 48/64 *2	0.1A (40°C) 0.05A (55°C)	-	-	2ms or lower *1

For all modules, the insulation system is photocoupler insulation and the output indications are LED indications.

- \*1 The dynamic scan cycle is 13.3ms (FAST mode) or 106.7ms (SLOW mode). (Set using the DIP switch on the module rear.)
- \*2 Set using the DIP switch on the module front.



	Field Wiring	Points/ Common	Surge Suppression	Fuse Rating	Error display	External Power Supply (TYP DC24V)	Internal Current Consumption	No. of Occupied Points
						Current		
	Terminal	8	Zener diode	5A	LED	0.020A	0.12A	16
	37-pin D-sub connector	32		3.2A		0.008A	0.5A	32
				Clamp diode	None	None	0.080A	
	40-pin connector ×2	32	Zener diode	3.2A	LED <sup>*5</sup>	0.008A	0.93A	64
	24-pin connector	-	None	1.6A	LED	0.055A	0.18A	16/32 48/64

\*3 Value at TYP 200VAC.

\*4 Value at TYP 12VDC.

\*5 "ERR." LED turns on when fuse is blown or external supply power is off.

\*6 0.08A is shown on the rating plate of the module.

\*7 0.15A is shown on the rating plate of the module.

## 5.2.2 Output module connections

### Connexions du module de sortie

(1)	Model	Rated Load Voltage
	A1SY10	24 VDC, 100 to 240 VAC

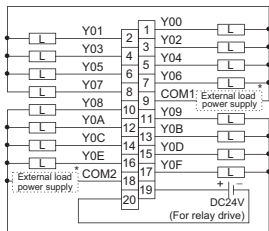

\*: The external load power supply section is as shown below.

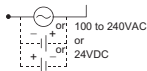

(2)	Model	Rated Load Voltage
	A1SY10EU	24 VDC, 100 to 120 VAC

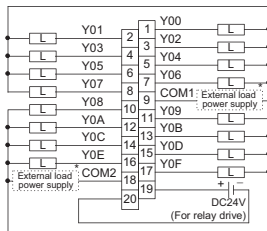

\*: The external load power supply section is as shown below.

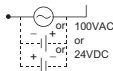

**⚠ WARNING**

● Do not touch any terminal during power distribution. Doing so may cause an electric shock or malfunctions.

**⚠ WARNING**

● Do not touch any terminal during power distribution. Doing so may cause an electric shock or malfunctions.

	Model	Rated Load Voltage
(3)	A1SY14EU	24 VDC, 100 to 240 VAC

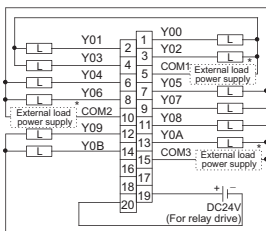

†: The external load power supply section is as shown below.

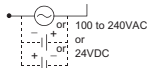

**⚠ WARNING**

- Do not touch any terminal during power distribution. Doing so may cause an electric shock or malfunctions.

	Model	Rated Load Voltage
(4)	A1SY18A	24 VDC, 100 to 240 VAC
	A1SY18AEU	

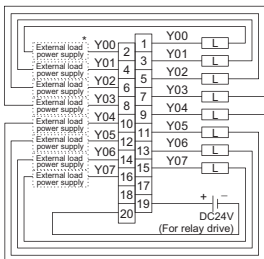

†: The external load power supply section is as shown below.

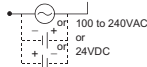

**⚠ WARNING**

- Do not touch any terminal during power distribution. Doing so may cause an electric shock or malfunctions.

(5)	Model	Rated Load Voltage
	A1SY22	100/200 VAC

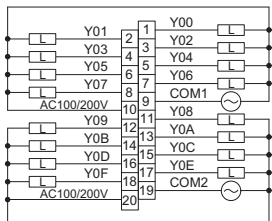

 WARNING

- Do not touch any terminal during power distribution. Doing so may cause an electric shock or malfunctions.

(6)	Model	Rated Load Voltage
	A1SY28A	100/200 VAC

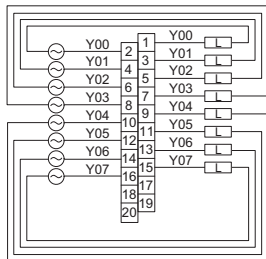

 WARNING

- Do not touch any terminal during power distribution. Doing so may cause an electric shock or malfunctions.

(7)	Model	Rated Load Voltage
	A1SY28EU	100-240 VAC

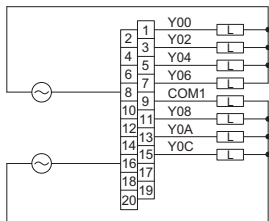

(8)	Model	Rated Load Voltage
	A1SY40	12/24 VAC
	A1SY40P	

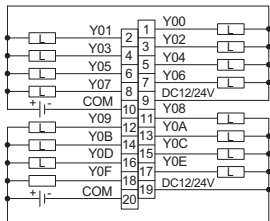

**⚠ WARNING**

- Do not touch any terminal during power distribution. Doing so may cause an electric shock or malfunctions.

(9)	Model	Rated Load Voltage
	A1SY50	12/24 VDC
	A1SY60	24 VDC

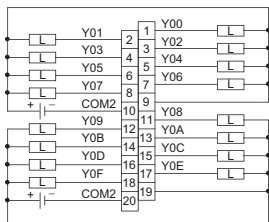

(10)	Model	Rated Load Voltage
	A1SY60E	5/12/24 VDC

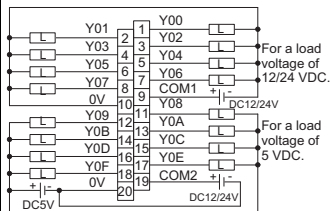

\* When using a working load voltage of 5VDC, a separate 12/24VDC source is required for the external power supply.

(11)	Model	Rated Load Voltage
	A1SY68A	5/12/24/48 VDC

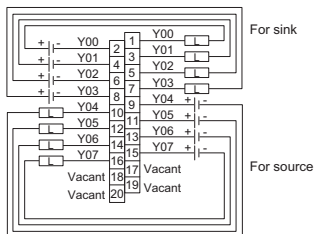

(12)	Model	Rated Load Voltage
	A1SY80	12/24 VAC

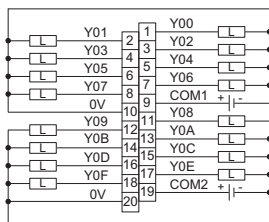

(13)	Model	Rated Load Voltage
	A1SY41 A1SY41P	12/24 VDC

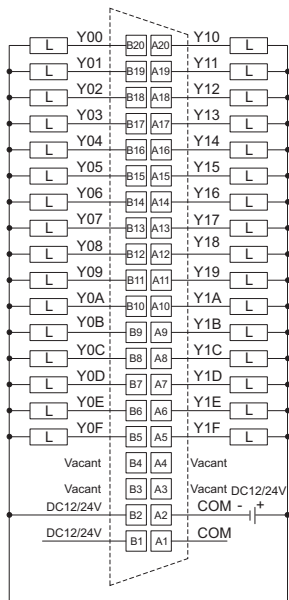

\*1 [B1] and [B2], and [A1] and [A2], are connected internally.

\*2 The A and B pin number rows shown above are transposed with respect to the diagram of the A and B rows which is printed on the module. Remember that the A row pin numbers correspond to the B row of the module.

(14)	Model	Rated Load Voltage
	A1SY42 A1SY42P	12/24 VDC

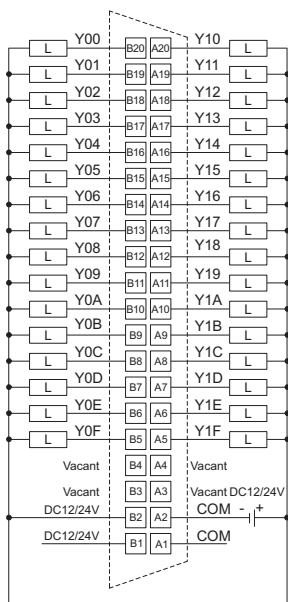

\*1 The figure above indicates [F] (the first half 32 points).

The connections for [L] (the latter half 32 points) are the same as for [F] (regard Y00 to Y1F as Y20 to Y3F.) [B1] and [B2], and [A1] and [A2], are connected internally.

\*2 The A and B pin number rows shown above are transposed with respect to the diagram of the A and B rows which is printed on the module. Remember that the A row pin numbers correspond to the B row of the module.

(15)	Model	Rated Load Voltage
	A1SY71	5/12 VDC

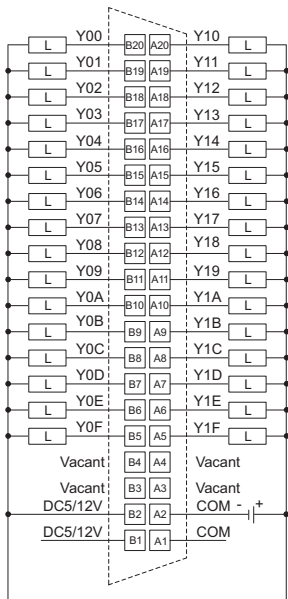

\*1 [B1] and [B2], and [A1] and [A2], are connected internally.

\*2 The A and B pin number rows shown above are transposed with respect to the diagram of the A and B rows which is printed on the module. Remember that the A row pin numbers correspond to the B row of the module.

(16)	Model	Rated Load Voltage
	A1SY81 A1SY81EP	12/24 VDC

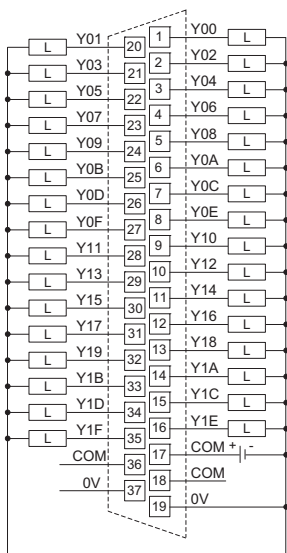

● [17] and [18] and [36], and [19] and [37] are connected internally.



(17)	Model	Rated Load Voltage
	A1SY82	12/24 VDC

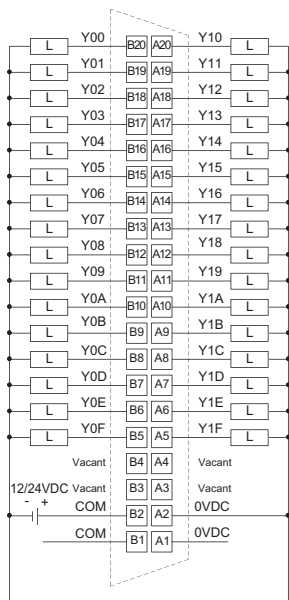

\*1 The figure above indicates [F] (the first half 32 points).

The connections for [L] (the latter half 32 points) are the same as for [F] (regard Y00 to Y1F as Y20 to Y3F.)

[B1] and [B2], and [A1] and [A2], are connected internally.

\*2 The A and B pin number rows shown above are transposed with respect to the diagram of the A and B rows which is printed on the module. Remember that the A row pin numbers correspond to the B row of the module.

(18)	Model	Rated Load Voltage
	A1S42Y	12/24 VDC

### Pin Arrangement

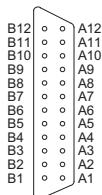

Seen from front face of the module

Pin No.	Signal Name (F <sub>H</sub> )	Pin No.	Signal Name (F <sub>H</sub> )
B12	YD0	A12	YD1
B11	YD2	A11	YD3
B10	YD4	A10	YD5
B9	YD6	A9	YD7
B8	YSCN0	A8	YSCN1
B7	YSCN2	A7	YSCN3
B6	YSCN4	A6	YSCN5
B5	YSCN6	A5	YSCN7
B4	Vacant	A4	Vacant
B3	12/24 VDC	A3	12/24 VDC
B2	0V	A2	0V
B1	Vacant	A1	Vacant

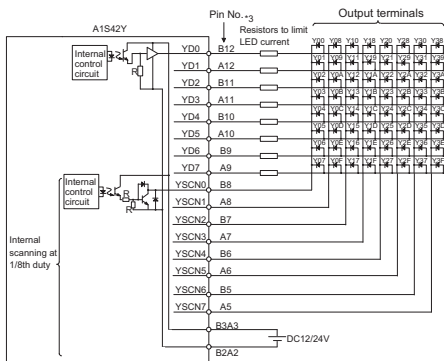

- \*1 The fuse in the output module is provided to prevent the external wiring from burning in the event of a short circuit in the module's output. Consequently, it may not be able to protect output devices. If an output device is damaged in a failure mode other than a short circuit, the fuse might not be blown.
- \*2 The "ERR." LED will also come ON when the external power supply is cut.

- \*3 Mount the resistors to limit LED current externally to the A1S42Y.



- \*4 The power supply voltage (12/24VDC) is applied in the LED's reverse direction. If the peak inverse voltage is insufficient, connect protective diodes in series with each of the LEDs.

English	French
[17] and [18] and [36], and [19] and [37] are connected internally.	[17], [18] et [36], ainsi que [19] et [37], sont connectés à l'intérieur.
[B1] and [B2], and [A1] and [A2], are connected internally.	[B1] et [B2], ainsi que [A1] et [A2], sont connectés à l'intérieur.
100 to 240 VAC	de 100 à 240 V ca
100 to 240VAC or 24VDC	100 à 240 V ca ou 24V cc
100/200 VAC	100/200 V ca
100-240 VAC	100-240 V ca
12/24 VAC	12/24 V ca
12/24 VDC	12/24 V cc
24 VDC	24 V cc
5/12 VDC	5/12 V cc
5/12/24 VDC	5/12/24 V cc
5/12/24/48 VDC	5/12/24/48 V cc
Consequently, it may not be able to protect output devices.	<i>Il ne peut donc assurer la protection des dispositifs de sortie.</i>
Do not touch any terminal during power distribution.	<i>Ne toucher à aucune des bornes quand l'équipement est sous tension.</i>
Doing so may cause an electric shock or malfunctions.	<i>Cela pourrait être à l'origine de chocs électriques ou de dysfonctionnements.</i>
External load power supply	<i>Alimentation charge externe</i>
For a load voltage of 12/24 VDC.	<i>Pour une tension de charge de 12/24 V cc</i>
For a load voltage of 5 VDC.	<i>Pour une tension de charge de 5 V cc</i>
For relay drive	<i>Pour attaque du relais</i>
For sink	<i>Pour dissipateur</i>
For source	<i>Pour source</i>
If an output device is damaged in a failure mode other than a short circuit, the fuse might not be blown.	<i>Si un dispositif de de sortie est endommagé en un mode de défaillance autre qu'un court-circuit, il se peut que le fusible ne saute pas.</i>
If the peak inverse voltage is insufficient, connect protective diodes in series with each of the LEDs.	<i>Si la tension inverse de pointe est insuffisante, raccorder des diodes de protection en série avec chacune des LED.</i>
Internal control circuit	<i>Circuit de commande interne</i>
Internal scanning at 1/8th duty	<i>Balayage interne à 1/8ème de cycle</i>
Model	<i>Modèle</i>
Mount the resistors to limit LED current externally to the A1S42Y.	<i>Installer des résistances pour limiter le courant LED à l'extérieur du A1S42Y.</i>

English	French
Output terminals	<i>Bornes de sortie</i>
Pin Arrangement	<i>Attribution des broches</i>
Pin No.	<i>Broche N°</i>
Rated Load Voltage	<i>Tension nominale de charge</i>
Remember that the A row pin numbers correspond to the B row of the module.	<i>Noter que les numéros de broche de rangée A correspondent à la rangée B sur le module.</i>
Resistors to limit LED current	<i>Résistance de limitation du courant LED</i>
Seen from front face of the module	<i>Vu depuis le devant du module</i>
Signal Name	<i>Nom de signal</i>
The "ERR." LED will also come ON when the external power supply is cut.	<i>La diode lumineuse "ERR" s'allume aussi quand l'alimentation externe est coupée.</i>
The A and B pin number rows shown above are transposed with respect to the diagram of the A and B rows which is printed on the module.	<i>Les rangées de broches A et B ci-dessous correspondent aux rangées de broches marquées A et B sur le schéma imprimé sur le module</i>
The connections for □L (the latter half 32 points) are the same as for □F (regard Y00 to Y1F as Y20 to Y3F.)	<i>Les connexions pour □L (deuxième moitié de 32 points) sont comme pour □F (considérer X00 à X1F comme état X20 à X3F.)</i>
The external load power supply section is as shown below.	<i>La section alimentation de la charge externe est comme représenté ci-dessous.</i>
The figure above indicates □F (the first half 32 points).	<i>La figure ci-dessus représente □F (première moitié de 32 points).</i>
The fuse in the output module is provided to prevent the external wiring from burning in the event of a short circuit in the module's output.	<i>Le rôle du fusible du module de sortie est d'éviter d'endommager le câblage externe dans l'éventualité d'un court-circuit de la sortie de module.</i>
The power supply voltage (12/24VDC) is applied in the LED's reverse direction.	<i>La tension d'alimentation (12/24 V cc) s'exerce en sens inverse de la LED.</i>
Vacant	<i>Libre</i>
WARNING	<i>AVERTISSEMENT</i>
When using a working load voltage of 5VDC, a separate 12/24VDC source is required for the external power supply.	<i>Pour utiliser une tension de charge utile de 5 V cc, il faut une source séparée 12/24 V cc pour l'alimentation externe.</i>



## 5.3 Input/output combined modules

### 5.3.1 Input/output combined module specifications

Model	Type	No. of Points	Rated Input Voltage	Input Current	Operating Voltage	
					ON Voltage	OFF Voltage
A1SH42	DC Input (sink type)	32	12/24VDC	2/5mA	8VDC or higher	4VDC or lower
A1SH42P						
A1SH42-S1			24VDC	5mA	15VDC or higher	3VDC or lower
A1SH42P-S1						
A1SX48Y18		8	24VDC	7mA	14VDC or higher	6.5VDC or lower
A1SX48Y58						

Model	Type	No. of Points	Rated Load Voltage	Max. Load Current		Max. Output Response Time	
				1 Point	Common	OFF to ON	ON to OFF
A1SH42	Transistor Output (sink type)	32	12/ 24VDC	0.1A	1.6A	2ms or lower	2ms or lower
A1SH42P					2A	1ms or lower	1ms or lower
A1SH42-S1					1.6A	2ms or lower	2ms or lower
A1SH42P-S1					2A	1ms or lower	1ms or lower
A1SX48Y18	Relay Output	8	24VDC 240VAC	2A	8A	10ms or lower	12ms or lower
A1SX48Y58	Transistor Output (sink type)		12/ 24VDC	0.5A	2A	2ms or lower	2ms or lower

For all modules, the insulation system is photocoupler insulation and the operation status is provided by LED indications.

	Max. Simultaneous Input Points (Percentage Simultaneously ON)	Max. Response Time		No. of Occupied Points
		OFF to ON	ON to OFF	
	60%(24VDC)	10ms or lower	10ms or lower	32
		0.3ms or lower	0.3ms or lower	
	100%(26.4VDC)	10ms or lower	10ms or lower	8

	Points/ Common	Field Wiring	Surge Suppression	Fuse Rating	External Power Supply (TYP 24VDC)	External Current Consumption (5VDC)	No. of Occupied Points
					Current		
	32	40-pin Connector	Zener diode	3.2A	0.008A	0.5A	32
				None	0.012A	0.13A	
				3.2A	0.008A	0.5A	
				None	0.012A	0.13A	
	8	Terminal	None	None	0.045A	0.085A	16
			Zener diode	3.2A	0.06A	0.06A	

## 5.3.2 Input/output composite module connections

### Connexions du module composite entrée/sortie

	Model	Rated Input Voltage	Rated Load Voltage
(1)	A1SH42	12/24 VDC	12/24 VDC
	A1SH42P		
	A1SH42-S1	24 VDC	
	A1SH42P-S1		

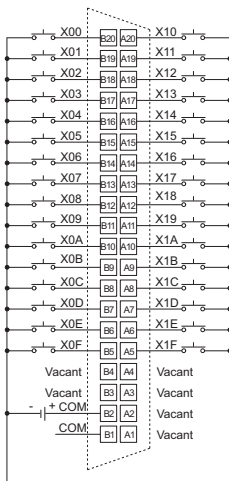

**X** (Input side)

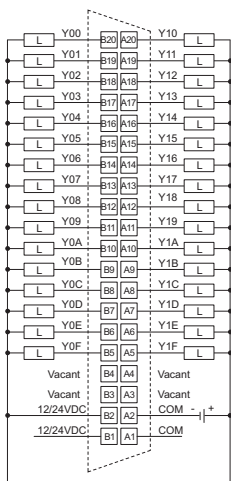

**Y** (Output side)

- \*1 **B1** and **B2** are connected internally.      \*3 **B1** and **B2**, and **A1** and **A2** are connected internally.

- \*2 The A and B pin number rows shown above are transposed with respect to the diagram of the A and B rows which is printed on the module. Remember that the A row pin numbers correspond to the B row of the module.



(2)	Model	Rated Input Voltage	Rated Load Voltage
	A1SJ-56DT	24 VDC	24 VDC

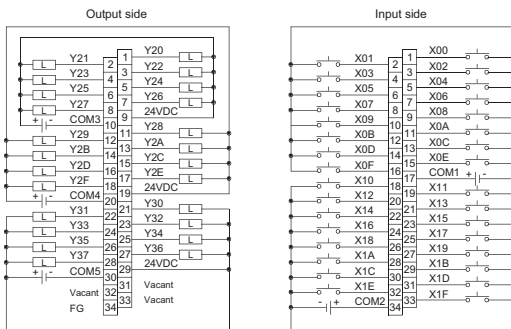

(3)	Model	Rated Input Voltage	Rated Load Voltage
	A1SJ-56R	24 VDC	100/200 VDC

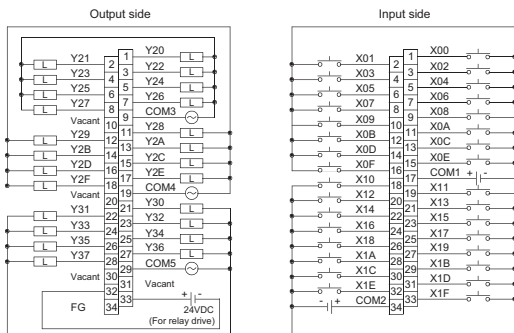

**WARNING**

- Do not touch any terminal during power distribution. Doing so may cause an electric shock or malfunctions.

(4)	Model	Rated Input Voltage	Rated Load Voltage
	A1SX48Y18	24 VDC	24 VDC/ 240 VAC

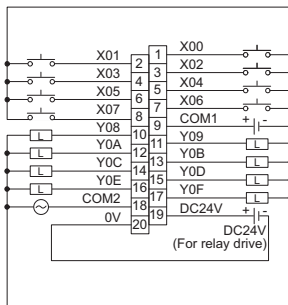

**WARNING**

- Do not touch any terminal during power distribution. Doing so may cause an electric shock or malfunctions.

(5)	Model	Rated Input Voltage	Rated Load Voltage
	A1SX48Y58	24 VDC	12/24 VDC

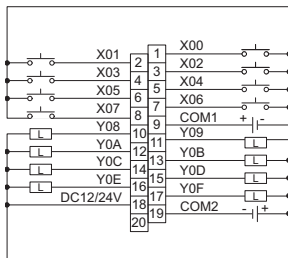

English	French
[B1] and [B2] are connected internally.	[B1] et [B2] sont connectés à l'intérieur.
[B1] and [B2], and [A1] and [A2] are connected internally.	[B1] et [B2], ainsi que [A1] et [A2], sont connectés à l'intérieur.
100/200 VDC	100/200 V cc
12/24 VDC	12/24 V cc
24 VDC	24 V cc
Do not touch any terminal during power distribution.	Ne toucher à aucune des bornes quand l'équipement est sous tension.
Doing so may cause an electric shock or malfunctions.	Cela pourrait être à l'origine de chocs électriques ou de dysfonctionnements.
Input side	Côté entrée
Model	Modèle
Output side	Côté sortie
Rated Input Voltage	Tension nominale d'entrée
Rated Load Voltage	Tension nominale de charge
Remember that the A row pin numbers correspond to the B row of the module.	Noter que les numéros de broche de rangée A correspondent à la rangée B sur le module.
The A and B pin number rows shown above are transposed with respect to the diagram of the A and B rows which is printed on the module.	Les rangées de broches A et B ci-dessous correspondent aux rangées de broches marquées A et B sur le schéma imprimé sur le module.
Vacant	Libre

---

---

## 6. ERROR CODES

---

---

### 6.1 Error Code List

If an error occurs in the RUN mode, an error display or error code (including a step number) is stored in the special register by the self-diagnosis function. The error code reading procedure and the causes of and corrective actions for errors are shown in Table 6.1

## 6.2 Error Codes

The following are the explanation about the descriptions and the causes of the error messages, error codes and the detailed error codes, and their correctives actions.

The detailed error codes are stored in D9092 only when using the dedicated instruction for CC-Link.

Table 6.1 Error Code List

Error Message	Error Code (D9008)	Detailed Error Code (D9092)	CPU States	Error and Cause	Corrective Action
"INSTRCT. CODE ERR"	10	—	Stop	Instruction code, which cannot be decoded by CPU module, is included in the program. (1) Memory cassette including instruction code, which cannot be decoded, has been loaded. (2) Since the memory contents have changed for some reason, instruction code, which cannot be decoded, has been included.	(1) Read the error step by use of peripheral equipment and correct the program at that step. (2) In the case of memory cassette, rewrite the contents or replace the cassette with a memory cassette which stores correct contents.
		101		Instruction code, which cannot be decoded by CPU module, is included in the program. (1) Memory cassette including instruction code, which cannot be decoded, has been loaded. (2) Since the memory contents have changed for some reason, instruction code, which cannot be decoded, has been included.	(1) Read the error step by use of peripheral equipment and correct the program at that step. (2) In the case of memory cassette, rewrite the contents or replace the cassette with a memory cassette which stores correct contents.
(Checked at STOP→RUN.)					

Table 6.1 Error Code List (Continue)

Error Message	Error Code (D9008)	Detailed Error Code (D9092)	CPU States	Error and Cause	Corrective Action
"INSTRCT. CODE ERR"  (Checked at STOP→ RUN.)	10	103	Stop	Device specified by a dedicated instruction for CC-Link is not correct.	Read the error step using a peripheral device and correct the program of the step.
		104		A dedicated instruction for CC-Link has incorrect program structure.	
		105		A dedicated instruction for CC-Link has incorrect command name.	
"PARAMETER ERROR"  (Checked at power-on or STOP/ PAUSE → RUN.)	11	—	Stop	The contents of parameters of CPU memory have changed due to noise or the improper loading of memory.	(1) Load the memory cassette correctly. (2) Read the parameter contents of CPU memory, check and correct the contents, and write them to CPU again.
"MISSING END INS." (Checked at STOP→ RUN.)	12	—	Stop	There is no <u>END</u> ( <u>FEND</u> ) instruction in the program.	Write <u>END</u> instruction at the end of program.

Table 6.1 Error Code List (Continue)

Error Message	Error Code (D9008)	Detailed Error Code (D9092)	CPU States	Error and Cause	Corrective Action
<p>"CAN'T EXECUTE (P)"</p> <p>(Checked at instruction execution.)</p>	13	—	Stop	<p>(1) There is no jump destination or multiple destinations specified by the <code>CJ</code>, <code>SCJ</code>, <code>CALL</code>, <code>CALLP</code>, or <code>JMP</code> instruction.</p> <p>(2) Although there is no <code>CALL</code> instruction, the <code>RET</code> instruction exists in the program and has been executed.</p> <p>(3) The <code>CJ</code>, <code>SCJ</code>, <code>CALL</code>, <code>CALLP</code>, or <code>JMP</code> instruction has been executed with its jump destination located below the <code>END</code> instruction.</p> <p>(4) The number of the <code>FOR</code> instructions is different from that of the <code>NEXT</code> instructions.</p> <p>(5) A <code>JMP</code> instruction is given within a <code>FOR to NEXT</code> loop causing the processing to exit the loop.</p> <p>(6) Processing exited subroutine by the <code>JMP</code> instruction before execution of the <code>RET</code> instruction.</p> <p>(7) Processing jumped into a step in a <code>FOR to NEXT</code> loop or into a subroutine by the <code>JMP</code> instruction.</p>	<p>Read the error step by use of peripheral equipment and correct the program at that step. (Insert a jump destination or reduce multiple destinations to one.)</p>

Table 6.1 Error Code List (Continue)

Error Message	Error Code (D9008)	Detailed Error Code (D9092)	CPU States	Error and Cause	Corrective Action
"CHK FORMAT ERR"	14	—	Stop	<p>(1) Instructions (including NOP) except LD X<sub>n</sub>, LDI X<sub>n</sub>, AND X<sub>n</sub> and ANI X<sub>n</sub> are included in the CHK instruction circuit block.</p> <p>(2) Multiple CHK instructions are given.</p> <p>(3) The number of contact points in the CHK instruction circuit block exceeds 150.</p> <p>(4) The device number of X in the CHK instruction circuit block exceeds X7FE.</p> <p>(5) There is no <del>CJP</del> circuit block before the CHK instruction circuit block.</p> <p>(6) The device number of D1 of the <del>CHKD1D2</del> instruction is different from that of the contact point before the <del>CJP</del> instruction.</p> <p>(7) Pointer P254 is not given to the head of the CHK instruction circuit block.</p> <p>P254<del>----CHKD1D2</del></p>	<p>(1) Check the program in the CHK instruction circuit block according to item (1) to (7) in the left column. Correct problem using the peripheral equipment and perform operation again.</p> <p>(2) This error code is only effective when the input/output control method is a direct method.</p>
(Checked at STOP/ PAUSE → RUN.)					



Table 6.1 Error Code List (Continue)

Error Message	Error Code (D9008)	Detailed Error Code (D9092)	CPU States	Error and Cause	Corrective Action
"CAN'T EXECUTE (I)"  (Checked at interrupt occurrence.)	15	—	Stop	<p>(1) Although the interrupt module is used, there is no number of interrupt pointer I, which corresponds to that module, in the program or there are multiple numbers.</p> <p>(2) No <code>IRET</code> instruction has been entered in the interrupt program.</p> <p>(3) There is <code>IRET</code> instruction in other than the interrupt program.</p>	<p>(1) Check for the presence of interrupt program which corresponds to the interrupt unit, create the interrupt program, and reduce the same numbers of I.</p> <p>(2) Check if there is <code>IRET</code> instruction in the interrupt program and enter the <code>IRET</code> instruction.</p> <p>(3) Check if there is <code>IRET</code> instruction in other than the interrupt program and delete the <code>IRET</code> instruction.</p>

Table 6.1 Error Code List (Continue)

Error Message	Error Code (D9008)	Detailed Error Code (D9092)	CPU States	Error and Cause	Corrective Action
"ROM ERR"  (Checked at power-on.)	17	—	Stop	Parameters and/or sequence programs are not correctly written to the mounted memory cassette.  Parameters stored in the memory cassette have exceeded the limit of available program capacity. Ex.) Default parameters (program capacity: 6k steps) are written to A1NMCA-2KE.	(1) Correctly write parameters and/or sequence programs to the memory cassette. (2) Remove the memory cassettes that contain no parameters or sequence programs.  (1) Adjust the program capacity for parameters to the memory cassette used. (2) Use the memory cassette of which memory capacity is larger than the program capacity for parameters.
"RAM ERROR"  (Checked at power-on.)	20	—	Stop	The CPU has checked if write and read operations can be performed properly to the data memory area of CPU, and as a result, either or both has not been performed.	Since this CPU hardware error, consult Mitsubishi representative.
"OPE. CIRCUIT ERR" (Checked at power-on.)	21	—	Stop	The operation circuit, which performs the sequence processing in the CPU, does not operate properly.	

Table 6.1 Error Code List (Continue)

Error Message	Error Code (D9008)	Detailed Error Code (D9092)	CPU States	Error and Cause	Corrective Action
"WDT ERROR"  (Checked at END instruction.)	22	—	Stop	Scan time exceeds watch dog error monitor time. (1) Scan time of user program has been exceeded for some conditions. (2) Scan time has lengthened due to instantaneous power failure which occurred during scan.	(1) Calculate and check the scan time of user program and reduce the scan time using the [CJ] instruction or the like. (2) Monitor the content of special register D9005 by use of peripheral equipment. When the content is other than 0, line voltage is insufficient. When the content is other than 0, the power voltage is unstable.
"END NOT EXECUTE"  (Checked at END processing.)	24	—	Stop	(1) When the [END] instruction was to be executed, the instruction was read as other instruction code due to noise or the like. (2) The [END] instruction has changed to another instruction code for some reason.	Reset and run the CPU module again. If the same error is displayed again, it is the CPU hardware error, consult Mitsubishi representative.
"WDT ERROR"	25	—	Stop	The [CJ] instruction or the like causes a loop in execution of the sequence program to disable execution of the [END] instruction.	Check the program for an endless loop and correct.

Table 6.1 Error Code List (Continue)

Error Message	Error Code (D9008)	Detailed Error Code (D9092)	CPU States	Error and Cause	Corrective Action
"UNIT VERIFY ERR."	31	—	Stop or Continue (set by parameter)	<p>I/O module data are different from those at power-on.</p> <p>(1) The I/O module (including the special function module) is incorrectly loaded or has been removed, or a different unit has been loaded.</p>	<p>(1) The bit in special registers D9116 to D9123 corresponding to the module causing the verification error is "1." Use a peripheral device to monitor the registers to locate the "1" bit, and check or replace the corresponding module.</p> <p>(2) To accept the current module arrangement, operate the RUN/STOP key switch to reset.</p>
"FUSE BREAK OFF"	32	—	Stop or Continue (set by parameter)	<p>(1) The fuse is blown in some output modules.</p> <p>(2) The external power supply for the output load is turned off or it is disconnected.</p>	<p>(1) Check the ERR LED of the output module. Replace the module with the lit LED.</p> <p>(2) Among special registers D9100 to D9107, the bit corresponding to the unit of fuse break is "1" Replace the fuse of a corresponding module. Monitor and check it.</p> <p>(3) Check ON/OFF of the external power supply for the output load.</p>

Table 6.1 Error Code List (Continue)

Error Message	Error Code (D9008)	Detailed Error Code (D9092)	CPU States	Error and Cause	Corrective Action
"CONTROL-BUS ERR."	40	—	Stop	The <b>FROM</b> and <b>TO</b> instructions cannot be executed. (1) Error of control bus with special function module.	The hardware of the special function module, CPU module or base unit is faulty. Replace the faulty module and check the faulty module. Consult Mitsubishi representative.
"SP. UNIT DOWN"	41	—	Stop	There is no reply from the special function module during execution of the <b>FROM</b> or <b>TO</b> instruction. (1) The special function module being accessed is faulty.	The hardware of the special function module being accessed is faulty. Consult Mitsubishi representative.
"I/O INT. ERROR"	43	—	Stop	Interrupt occurs though no interrupt module is installed.	The hardware of a module is faulty. Replace the module and check the faulty module. Consult Mitsubishi representative.

Table 6.1 Error Code List (Continue)

Error Message	Error Code (D9008)	Detailed Error Code (D9092)	CPU States	Error and Cause	Corrective Action
"SP. UNIT LAY. ERROR."	44	—	Stop	<ul style="list-style-type: none"> <li>(1) Three or more computer link modules are installed for a single CPU module.</li> <li>(2) Two or more MELSECNET (II), MELSECNET /B or MELSECNET /10 data link modules are installed.</li> <li>(3) Two or more interrupt modules are installed.</li> <li>(4) A special function module is installed to a slot assigned to the I/O module with parameter setup of the peripheral device, or vice versa.</li> <li>(5) The I/O module or special function module is installed outside the following I/O number ranges, or GOT is connected to the bus. A1SH, A1SJHCPU: X0 to XFF A2SHCPU(S1): X0 to X1FF</li> </ul>	<ul style="list-style-type: none"> <li>(1) Reduce the number of computer link modules to within two.</li> <li>(2) Reduce the number of MELSECNET (II), MELSECNET /B and MELSECNET /10 data link modules to one.</li> <li>(3) Reduce the number of interrupt modules to one.</li> <li>(4) Using the peripheral device, correct the parameter I/O assignment according to the actual state of installation of the special function modules.</li> <li>(5) Examine the I/O number and remove the modules and GOT installed outside the range specified on the left.</li> </ul>

Table 6.1 Error Code List (Continue)

Error Message	Error Code (D9008)	Detailed Error Code (D9092)	CPU States	Error and Cause	Corrective Action
"SP. UNIT ERROR"  (Checked at FROM/TO instructions or a special function module dedicated instruction.)	46	—	Stop or Continue (set by parameter)	(1) Access (execution of FROM or TO instruction) has been made to a location where no special function module is installed.	(1) Use the peripheral device to read and correct the FROM and/or TO instruction at the error step.
		462		(1) There is inconsistency in the module name between the special instruction for CC-Link and I/O assignment of the parameter. (2) The location designated by the special instruction for CC-Link is not the master module.	(1) Correct the module name of I/O assignment of the parameter to that of the special instruction for CC-Link. (2) Use the peripheral device to check and correct the special instruction for CC-Link at the error step.
"LINK PARA. ERROR"	47	—	Continue	(1) There is inconsistency for some reason between the data, which is written by the peripheral device in the parameter area of the link under link range designation using parameter setup, and the link parameter data read by the CPU module. (2) The total number of stations is set at "0."	(1) Write parameters and check again. (2) If the error persists, there is a fault in hardware. Consult Mitsubishi representative.

Table 6.1 Error Code List (Continue)

Error Message	Error Code (D9008)	Detailed Error Code (D9092)	CPU States	Error and Cause	Corrective Action
"OPERATION ERROR"  (Checked at instruction execution.)	50	—	Stop or Continue (set by parameter)	(1) The result of BCD conversion exceeds the rated range ("9999" or "99999999"). (2) There is a setting exceeding the rated device range, disabling execution of calculation. (3) The file register is used on the program without designation of the capacity of the file register.	Use the peripheral device to read and correct the error step in the program. (Check the setting range of the device, BCD conversion value and so on.)
		503		The data stored by the designated device or a constant exceeds the allowable range.	Use the peripheral device to read and correct the error step in the program.
		504		The setting quantity of handled data exceeds the allowable range.	
		509		The number of special instructions for CC-Link executed in each scan exceeds 64.	Reduce the special instructions for CC-Link executed in each scan to within 64.
				A special instruction for CC-Link is executed to a CC-Link module to which no parameter is defined.	Define parameters.
"MAIN CPU DOWN"	60	—	Stop	(1) The CPU malfunctioned due to noise. (2) Hardware failure.	(1) Take proper countermeasures for noise. (2) Consult Mitsubishi representative.
"BATTERY ERROR"  (Always checked.)	70	—	Continue	(1) The battery voltage is low. (2) The battery lead connector is not connected.	(1) Replace the battery. (2) Connect the lead connector to use the built-in RAM memory or power failure compensation function.



---

---

## APPENDICES

---

---

### Appendix 1 CPU-by-CPU Startup Names

CPU	Startup Name	CPU Name to Be Selected If the CPU Name Given on the Left Is Not Found
A1SJHCPU	A1SJH	A3

### Appendix 2 Transportation Precautions

When transporting lithium batteries, make sure to treat them based on the transportation regulations.

#### Appendix 2.1 Relevant Models

The battery for the A1SJHCPU (including memory cards) is classified as shown in the table below.

Product Name	Model	Description	Handled As
A series battery	A6BAT	Lithium battery	Non-dangerous goods

#### Appendix 2.2 Transportation Guidelines

Products are packed properly in compliance with the transportation regulations prior to shipment. When repacking any of the unpacked products to transport it to another location, make sure to observe the IATA Dangerous Goods Regulations, IMDG Code and other local transportation regulations.

For details, please consult your transportation company.

# MEMO

---

---

---

---

---

---

---

---

---

---

---

---

---

---

---

---

---

---

---

---

---

---

---

---

---

---

---

---

---

---

## **WARRANTY**

Please confirm the following product warranty details before using this product.

### **1. Gratis Warranty Term and Gratis Warranty Range**

If any faults or defects (hereinafter "Failure") found to be the responsibility of Mitsubishi occurs during use of the product within the gratis warranty term, the product shall be repaired at no cost via the sales representative or Mitsubishi Service Company.

However, if repairs are required onsite at domestic or overseas location, expenses to send an engineer will be solely at the customer's discretion. Mitsubishi shall not be held responsible for any re-commissioning, maintenance, or testing on-site that involves replacement of the failed module.

#### **[Gratis Warranty Term]**

The gratis warranty term of the product shall be for one year after the date of purchase or delivery to a designated place.

Note that after manufacture and shipment from Mitsubishi, the maximum distribution period shall be six (6) months, and the longest gratis warranty term after manufacturing shall be eighteen (18) months. The gratis warranty term of repair parts shall not exceed the gratis warranty term before repairs.

#### **[Gratis Warranty Range]**

- (1)The range shall be limited to normal use within the usage state, usage methods and usage environment, etc., which follow the conditions and precautions, etc., given in the instruction manual, user's manual and caution labels on the product.
- (2)Even within the gratis warranty term, repairs shall be charged for in the following cases.
  - 1.Failure occurring from inappropriate storage or handling, carelessness or negligence by the user. Failure caused by the user's hardware or software design.
  - 2.Failure caused by unapproved modifications, etc., to the product by the user.
  - 3.When the Mitsubishi product is assembled into a user's device, Failure that could have been avoided if functions or structures, judged as necessary in the legal safety measures the user's device is subject to or as necessary by industry standards, had been provided.
  - 4.Failure that could have been avoided if consumable parts (battery, backlight, fuse, etc.) designated in the instruction manual had been correctly serviced or replaced.
  - 5.Failure caused by external irresistible forces such as fires or abnormal voltages, and Failure caused by force majeure such as earthquakes, lightning, wind and water damage.
  - 6.Failure caused by reasons unpredictable by scientific technology standards at time of shipment from Mitsubishi.
  - 7.Any other failure found not to be the responsibility of Mitsubishi or that admitted not to be so by the user.

## **2. Onerous repair term after discontinuation of production**

(1) Mitsubishi shall accept onerous product repairs for seven (7) years after production of the product is discontinued.

Discontinuation of production shall be notified with Mitsubishi Technical Bulletins, etc.

(2) Product supply (including repair parts) is not available after production is discontinued.

## **3. Overseas service**

Overseas, repairs shall be accepted by Mitsubishi's local overseas FA Center. Note that the repair conditions at each FA Center may differ.

## **4. Exclusion of loss in opportunity and secondary loss from warranty liability**

Regardless of the gratis warranty term, Mitsubishi shall not be liable for compensation of damages caused by any cause found not to be the responsibility of Mitsubishi, loss in opportunity, lost profits incurred to the user by Failures of Mitsubishi products, special damages and secondary damages whether foreseeable or not, compensation for accidents, and compensation for damages to products other than Mitsubishi products, replacement by the user, maintenance of on-site equipment, start-up test run and other tasks.

## **5. Changes in product specifications**

The specifications given in the catalogs, manuals or technical documents are subject to change without prior notice.



<b>Country/Region</b>	<b>Sales office/Tel</b>	<b>Country/Region</b>	<b>Sales office/Tel</b>
U.S.A	Mitsubishi Electric Automation Inc. 500 Corporate Woods Parkway Vernon Hills, IL 60061, U.S.A. Tel : +1-847-478-2100	China	Mitsubishi Electric Automation (China) Ltd. 4/F Zhi Fu Plaza, No.80 Xin Chang Road, Shanghai 200003, China Tel : +86-21-6120-0808
Brazil	MELCO-TEC Rep. Com.e Assessoria Tecnica Ltda. Rua Correia Dias, 184, Edificio Paraiso Trade Center-8 andar Paraiso, Sao Paulo, SP Brazil Tel : +55-11-5908-8331	Taiwan	Setsuyo Enterprise Co., Ltd. 6F No.105 Wu-Kung 3rd.Rd, Wu-Ku Hsiang, Taipei Hsine, Taiwan Tel : +886-2-2299-2499
Germany	Mitsubishi Electric Europe B.V. German Branch Gothaer Strasse 8 D-40880 Ratingen, GERMANY Tel : +49-2102-486-0	Korea	Mitsubishi Electric Automation Korea Co., Ltd. 1480-6, Gayang-dong, Gangseo-ku Seoul 157-200, Korea Tel : +82-2-3660-9552
U.K	Mitsubishi Electric Europe B.V. UK Branch Travellers Lane, Hatfield, Hertfordshire., AL10 8XB, U.K. Tel : +44-1707-276100	Singapore	Mitsubishi Electric Asia Pte, Ltd. 307 Alexandra Road #05-01/02, Mitsubishi Electric Building, Singapore 159943 Tel : +65-6470-2480
Italy	Mitsubishi Electric Europe B.V. Italian Branch Centro Dir. Colleoni, Pal. Perseo-Ingr.2 Via Paracelso 12, I-20041 Agrate Brianza., Milano, Italy Tel : +39-039-60531	Thailand	Mitsubishi Electric Automation (Thailand) Co., Ltd. Bang-Chan Industrial Estate No.111 Moo 4, Serithai Rd, T.Kannayao, A.Kannayao, Bangkok 10230 Thailand Tel : +66-2-517-1326
Spain	Mitsubishi Electric Europe B.V. Spanish Branch Carretera de Rubi 76-80, E-08190 Sant Cugat del Valles, Barcelona, Spain Tel : +34-93-565-3131	Indonesia	P.T. Autoteknindo Sumber Makmur Muara Karang Selatan, Block A/Utara No.1 Kav. No.11 Kawasan Industri Pergudangan Jakarta - Utara 14440, P.O.Box 5045 Jakarta, 11050 Indonesia Tel : +62-21-6630833
France	Mitsubishi Electric Europe B.V. French Branch 25, Boulevard des Bouvets, F-92741 Nanterre Cedex, France Tel : +33-1-5568-5568	India	Messung Systems Pvt, Ltd. Electronic Sadan NO:III Unit No15, M.I.D.C Bhosari, Pune-411026, India Tel : +91-20-2712-3130
South Africa	Circuit Breaker Industries Ltd. Private Bag 2016, ZA-1600 Isando, South Africa Tel : +27-11-928-2000	Australia	Mitsubishi Electric Australia Pty. Ltd. 348 Victoria Road, Rydalmere, N.S.W 2116, Australia Tel : +61-2-9684-7777

## **MITSUBISHI ELECTRIC CORPORATION**

HEAD OFFICE: TOKYO BUILDING, 2-7-3 MARUNOUCHI, CHYODA-KU, TOKYO 100-8310, JAPAN  
NAGOYA WORKS: 1-14, YADA-MINAMI 5-CHOME, HIGASHI-KU, NAGOYA, JAPAN

When exported from Japan, this manual does not require application to the Ministry of Economy, Trade and Industry for service transaction permission.

Specifications subject to change without notice.