



# User's Manual

**Home CR-H408**

**4-Bay Portable RAID Tower**

**EXTERNAL 4 BAY SATA RAID *USB3.0* & eSATA  
ENCLOSURE**



## Table of contents

Chapter 1 Read Me First.....	3
1-1 About this manual.....	3
1-2 Notices .....	3
1-3 The policy of software and an attention matter of a manual .....	6
Chapter 2 Introduction .....	7
2-1 Introduction .....	7
2-2 Specifications .....	7
2-3 System requirements.....	8
Chapter 3 Package contents and parts description.....	9
3-1 Package contents.....	9
3-2 Parts description.....	9
Chapter 4 HDD installation and setup of a hard disk.....	12
4-1 To install the Hard disks.....	12
4-2 The setting of DIP mode switch .....	13
4-2-1 The Mode function & DIP switch definition.....	14
4-2-2 RAID Mode setting via RAID Manager Software.....	15
Chapter 5 Initialization and formatting the hard disk .....	17
5-1 Initialization in Windows 2000 / XP / 7 .....	17
5-2 Initialization in Windows ME / 98SE.....	17
5-3 Initialization in Mac OS X.....	17
Chapter 6 How to use this product.....	18
6-1 Using the USB 4X HDD .....	18
6-2 Basics operation.....	18
Chapter 7 Trouble Shooting .....	20

# Chapter 1

## Read me first





### 1-1 About this Manual

Thank you very much for your purchasing of **CineRAID Home CR-H408**, the "EXTERNAL 4 BAY SATA RAID to USB 3.0 & eSATA CASE"

- This manual describe the complete details and operating instruction of this products Please read the manual before using the product.
- We reserve the right of any change in the specifications without notice.







### 1-2 Notice

- Please! use this product safely
  - Please read the below notes before starting.
  - Please keep this manual in a place you can reach at any time when using the unit.
- Safety Notices
  - Before use of this device, be sure to check the following items.

 Warning	A warning describes information you need to avoid possible personal injury or damage to equipment or data.
 Attention	An attention describes information you need to pay attention to avoid possible personal injury or damage to equipment or data.
	A warning or attention mark
	A mark of an act of prohibition.
	A mark describes information you must do to avoid possible personal injury or damage to equipment or data.











## Warning

 <p>Strictly observance</p>	<p>When using this product, please be absolutely careful about the warning that a maker of a PC and peripheral equipment of use orders, attention indication.</p>
 <p>Prohibited from disassembling</p>	<p>Prohibited from disassembling or repaired this product by oneself and disintegrate, and please do not remodel it.</p> <p>If caused a fire and an electric shock, a burn, trouble. Please! Ask your distributor for repair. If disintegrate and remodeled it, there are charged repair and situation even if it is in a guarantee period.</p>
 <p>Pull the plug</p>	<p>If smoke appears strange smells or strange sounds, please pull the plug out of the outlet immediately.</p> <p>This may cause fire or electric shock.</p>
 <p>Notice of fire</p>	<p>Please! Follow up on this user guide to setup your device.</p> <ul style="list-style-type: none"><li>* Do not pull, or bend on the USB cable or power cord. It may cause a fire and/or fault of the device.</li><li>* Make sure the power cable is connected correctly otherwise it may cause a fire and/or fault of the device.</li><li>* Please never connect the LAN cable to the device. When connected, a LAN cable can cause a fire.</li></ul>
 <p>Strictly observance</p>	<p>Please completely insert the power supply plug into an outlet.</p> <p>When assembling or disassembling this product, please read the method in this manual before you start. Doing otherwise may cause a fire, an electric shock or device fault by your mistake.</p>
 <p>Strictly prohibit Paint with water</p>	<p><b>Please</b> do not use the device in the bathroom. It may cause a fire or electric shock.</p> <p>After transportation, wait till the device setting to the room temperature before using it. The large difference in temperature or humidity may cause a tough condensation and cause an electrical short circuit.</p>



**An attention matter on having you use this product**

 <p>Prohibit from foot wiring housing</p>	<p>Please connect a power supply outlet to a power supply outlet directly if possible.</p> <p>At AC power core foot wiring housing, if use of several outlet possibly causing a fire.</p>
 <p>Prohibit</p>	<p>Do not cover your 4XSATA enclosure, this could lead to overheating your device.</p>
 <p>Prohibit</p>	<p>Please keep the device away from a place that is easy to cause shock and vibration.</p> <p>Please keep the device away from a place with high temperature, high humidity and/or high dust. Do not expose the drive to direct sunlight or heat.</p> <p>Make sure the device is located at least one meter away from sources of high frequency and/or magnetic disturbance (TV, Speaker, Mobile phone etc) in order to avoid data loss and operational problems.</p>
 <p>Prohibit</p>	<p>Do not turn off the device or unplug the USB cable when the access LEDs are on, also, do not reset the PC. This will cause trouble, and data loss</p>
 <p>Attention</p>	<p>Do not let children play with the device. Children cannot recognize the possible danger.</p>
 <p>Attention</p>	<p>Do not cover the device with any other things, it will disable the cooling system and cause a temp increase of the HDD. This will cause the HDD fail. Be sure to use the device at room temperature.</p>
 <p>Attention</p>	<p>Every time you update your data make back-up copies on the external storage medium.</p> <p>We do not assume liability for data loss or damage to data storage unit, no claims can be accepted for damages resulting from loss of data or consequential losses.</p>
 <p>Attention</p>	<p>Please do not install software in this product. There is the situation that software (word processor software, game software) cannot take advantage of why a program carried out at the time of OS start is not found in normally.</p>

### **1-3 The policy of software and the information of this manual**

#### **◆ The policy of software program**

Please keep this manual as the proof of license agreement of this product (we say" a license agreement" including a program manual or other attachment documents) and agree to be used as copyright requirement.

1. Please read the software licensed agreement and use the software with copyright with the computer which is owned by you.
2. Copy and reproduce a software with copyright is prohibited.
3. The software license can not be used by another person by any method.
4. It is not allowed to modify software without our permission.
5. It is not allowed to rent the software to any one.
6. We do not assume liability for data loss or damage to data storage unit, and no claims can be accepted for damages resulting from loss of data or consequential losses that you use the copied software.
7. The customer service will be acceptable with above items.
8. It is against the copyright laws if you against any items of 1 to 6.

#### **◆ An attention for this manual**

1. The information in this manual is subject to change without notice.
2. Please notify us if there have any errors in this manual.
3. While reasonable efforts have been made in the preparation of this document to assure its accuracy, we assume no liability resulting from errors or omissions in this document, or from the use of the information contained.

\* Microsoft is a registered trademark of Microsoft Corporation.

MS DOS, Windows Me, Windows 2000 and the Windows XP logo are trademarks of Microsoft Corporation.

\* Macintosh and Mac OS are registered trademarks of Apple Computer, Inc.

\* In addition, a company name / product name mentioned in this book is a trademark of the companies or a registered trademark.

\* As for this book, a right such as a copyright is protected by "Copyright Act".

# Chapter 2 Introduction

## 2-1 Introduction

**CineRAID Home CR-H408** supports maximum 4 SATA HDD with RAID & JBOD functions, and the latest USB 3.0 technology, the data transfer rate up to 5Gb/s; eSATA data transfer rate up to 3Gb/s. It is desirable to be able to use all the disks as if they were one single volume (cf. # P.16). There are 7 RAID modes for max 4 hard disks - the RAID 0, 1, 3, 5, 10 and JBOD which can combine 4 drives into one larger logical volume for the data safety. A RAID system is an ideal tool to secure valuable data. Supports the SATA Port Multiplier function, it works without any express card to read the multi bay SATA enclosure.

Notice # 1: When connecting one volume or combined volume of more than 137GB, the version of OS needs to be the Windows 2000 SP-3/Windows XP SP-1 or later. In Windows 98SE/ME, you can not make one volume (a partition) more than 137GB or more than 137GB at "a combine mode".

## 2-2 Specifications

### ■ Dimension

L256 x W134 x H178 mm (except a projection part)

### ■ Weight

2.4 KGS or 6.5 lbs (Doesn't include the Hard Disk)

### ■ Interface

- Host Interface: USB 3.0 , eSATA
- HDD Device: SATA/II

### ■ Power supply specifications

The input: 100V - 240V

The output: +5V 4.0A / +12V 6.0A (maximum)

It may not work normally, if power consumption over than the above standard.

### ■ Operating Environment

Temperature 41 °C - 95 °F

Humidity 20% - 80% (a thing without dew condensation)

## 2-3 System requirements

### ■ Support OS

IBM PC/AT compatible machine (including the NEC PC-98NX series) with USB2.0 or USB1.1 / SATA I or SATAII interface.

The following series (only a model released in after March, 2001 of the PowerPC deployment copes) of Apple Macintosh

\* PowerMac G4/G5, PowerBookG4, i-Book, e-Mac, each model of Mac mini.

\* Recommend what is used in an USB3.0 equipment model.

### <Attention>

- The below model may not work normal so that there is a possibility it does not support the updated model(s) of machines.
  - The DynaBook PORTAGE, Satellite series (a thing of the K6 CPU deployment) made by Toshiba
  - Aptiva E series (a thing of the AMD K6 CPU deployment) made by IBM, The e-note M260 series made by SOTEC.
- 3566/3567/3576/3581/ 3590 which made by HP/COMPAQ.
- It is not guaranteed of compatibility in all environments.
- There is the case assume that specific machinery, affinity with software are out of support.

### ■ Interface

HDD Device: SATA I/II interface

\* Host(include Apple Mac series): USB3.0 interface or eSATA interface

### ■ The Operating System

Windows7/ Windows Vista / XP Home Edition SP-1/Professional SP-1 /Windows 2000 Professional SP-3 , Windows Me and Windows 98SE or later version. (# 1, 2, 3)

After Apple Mac OS X 10.3 (recommended in 10.3.9 or 10.4 latest edition)

#1. Not applicable to use one volume more than 137GB or 137GB at “combine mode” in Windows ME / 98SE.

#2. It is not guaranteed that works with Windows 98(a first edition).

The LBA(Logical Block Addressing) of IDE interface compatible with 3.5” and 2.5” Hard disks (Need Optional 2.5” to 3.5” Adapter)

Notice: This product can not work with power source from USB bus power only. Please connect the attached power supply cord by all means.











# Chapter 3 Package contents and parts description

## 3-1 Package contents

Please check the package contents when you open the package.

1. Home CR-H408 main unit
2. USB 3.0 Cable
3. Power supply Cable
4. Users manual
5. SATA Cable
6. HDD holders.
7. 20 pieces of installation screws for 3.5" HDD holder
8. 8 pieces of installation screws for 3.5" HDD
9. This Quick Start Guide

			
Main bodyX1	USB3.0 cableX1	eSATA cableX1	HDD holderX5
			
ScrewsX20	ScrewsX8	Power Cable	User manual

**Please contact your dealer's support center if there are items missed in the package.**

**In addition, please keep the box and packing materials, which may be used in the case of the transportation such as repair or removal.**

### 3-2 Parts description

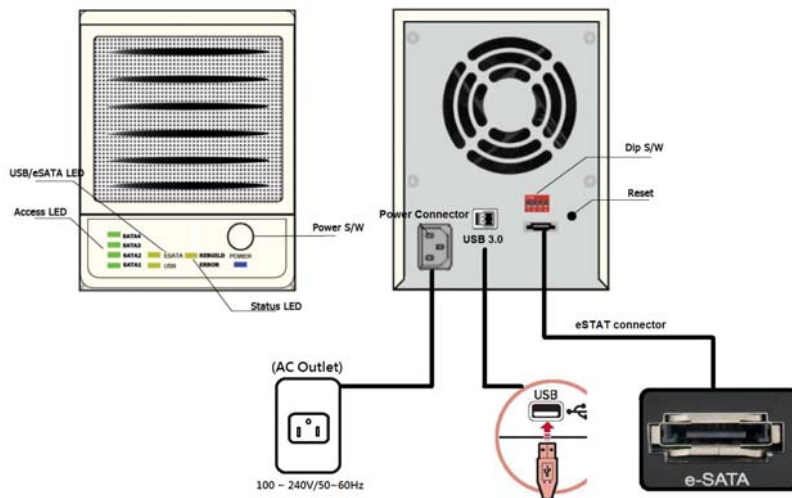

#### 1) **USB/ eSATA LED:**

ESATA LED : Connect with eSATA interface

USB LED : Connect with USB3.0 interface

#### 2) **Access LED:** SATA 4~SATA1,

LED ON : The HDD has been installed in the device

LED Blinking: HDD error or damage

LED OFF : There are no any HDD in the device

#### 3) **Status LED:** Used to indicate the situation of the device. (Two Color LED)

1. GREEN - HDD OK

2. RED - HDD FAILS

3. GREEN / RED - REBUILD.

#### 4) **Power switch:** ON/OFF switch ON or OFF device power.

#### 5) **Power connector:** Connect to an AC power outlet with the attached power supply cable.

#### 6) **USB 3.0 connector:** Connected to an USB 3.0 port of a PC with an attached USB3.0 cable

#### 7) **DIP switch:** The mode setting switch. For the details please refer to the Chapter 4-2.

#### 8) **eSATA connector:** connected to an eSATA port of a PC with an attached SATA cable.

9) **Reset:** press and hold reset button, turn on box, keep hold reset button for 15sec, tune off box, release reset button to reset the RAID before the change of the RAID mode.



(Note 1): Because there is a high heating possibility of Hard Disk. Please to confirm the fan on the back side is in good condition.

# Chapter 4 HDD installation and setting of a hard disk

## 4-1 To install the Hard disks

Please remove the plug from the power supply outlet before assembling the hard disk, it will cause an electric shock and/or damage if not disconnected.

	<p>1. Please remove the front cover of the enclosure, the cover can be fully moved from the enclosure.</p>
	<p>2. Place the HDD and fasten on the HDD holder with 4 screws, each HDD holder</p> 
	<p>3. Install 2 screws on each HDD</p> 
	<p>4. Slide the SATA HDD on the holder into the enclosure until you hear a click sound to confirm the HDD holder is in position.</p>
	<p>5. After the HDDs are all installed in the enclosure, put the front cover back to enclosure, then connect the SATA or USB 3.0 cable.</p>

## 4-2 The setting of DIP mode switch

First, please relocate the DIP switch at rear side of the case.

A, To reset all RAID modes, please set every Dip/SW at OFF position then hold reset button and turn ON the power of enclosure, pthen shut down the device and release reset button to complete the mode reset.

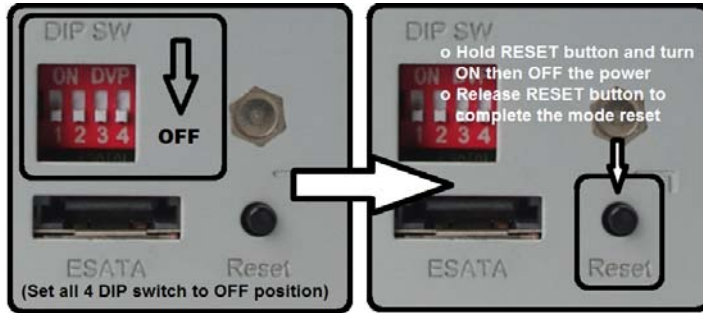

B. To set the DIP switch to a new RAID mode, please follow the mode chart as below, press the RESET button and hold it, turn on the box and keep hold reset button for 15sec.

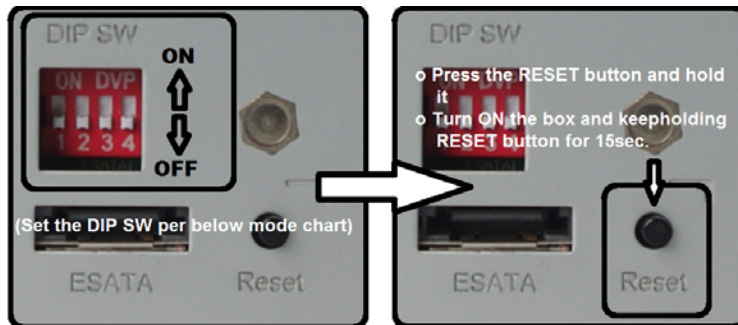

DIP switch code(from left to right) "DIP switch 1", "DIP switch 2" and "DIP switch 3" "DIP switch 4".



**Reset:** please press and hold for 15 seconds RESET button when change any RAID mode.

ITEM	S/W 1	S/W2	S/W3	S/W4	MODE
1	OFF	ON	ON	ON	RAID0
2	OFF	ON	ON	OFF	RAID1/RAID10
3	OFF	ON	OFF	OFF	RAID3
4	OFF	OFF	ON	OFF	RAID5
5	OFF	OFF	ON	ON	CLONE
6	OFF	ON	OFF	ON	LARGE
7	OFF	OFF	OFF	OFF	NORMAL

4-2-1 The Mode Function & DIP switch definition

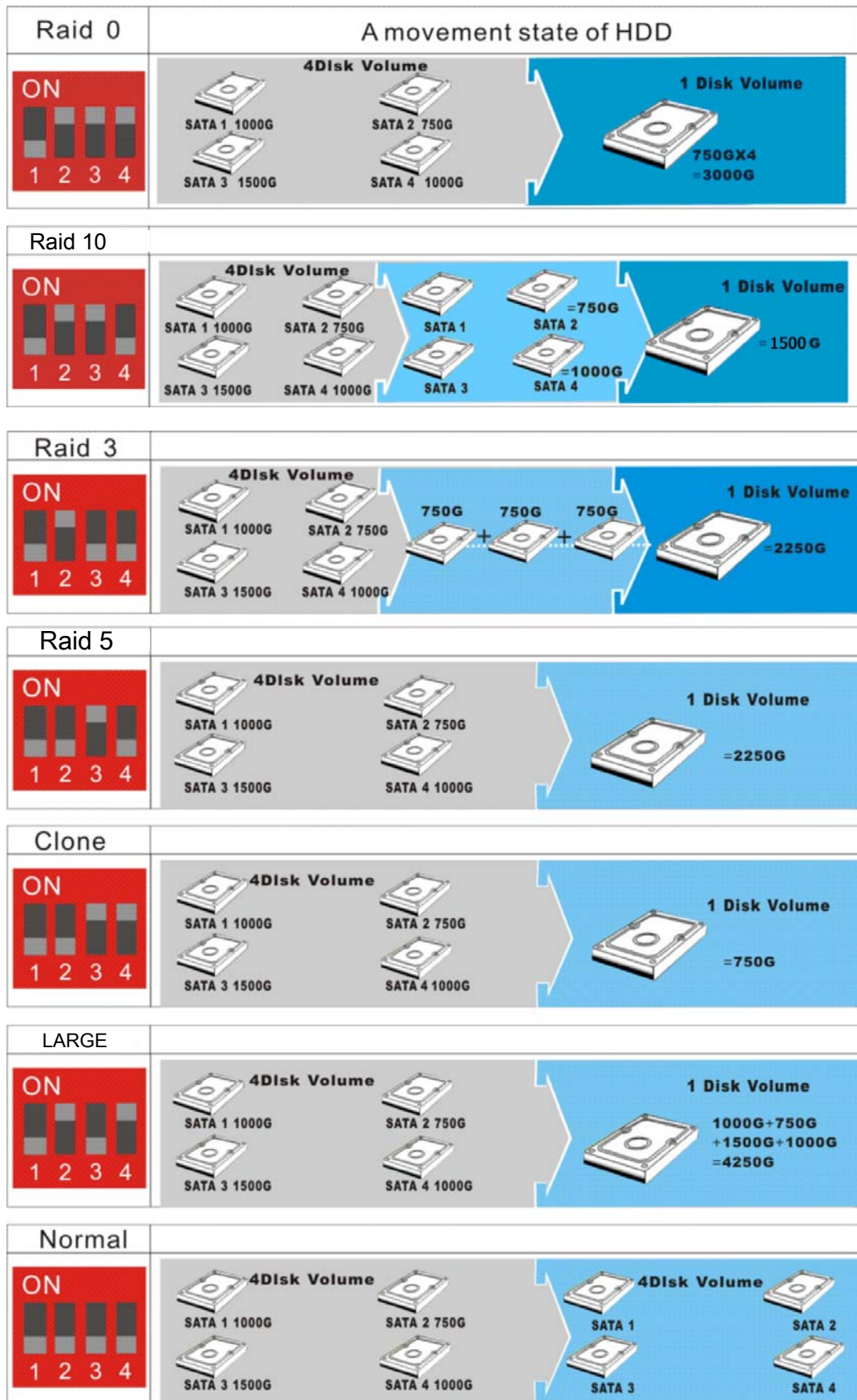

#### 4-2-2 The RAID Mode Setting via Management software. Home CR-H408 comes with a RAID Manager software disk.

Insert the CD onto CD-ROM drive of you computer, then click “CineRAID” folder in the CD, double click on “Setup” to run the Management software installation:

📁 CineRAID Linux AP\_VO.09.43  
📁 CineRAID windows AP\_VO.09.43



- The display screen will pop up the Installation Wizard dialog box, click “Install” to start software installation; click “Finish” after the installation is done

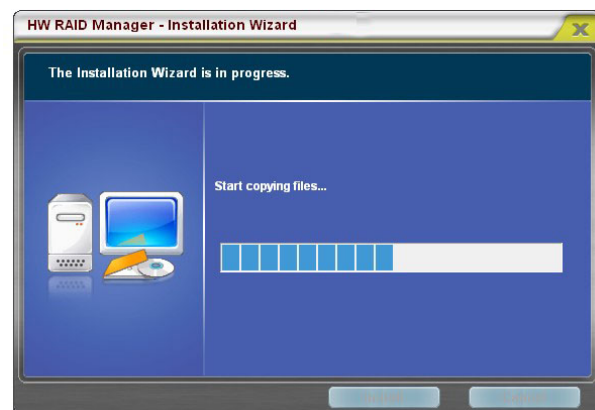
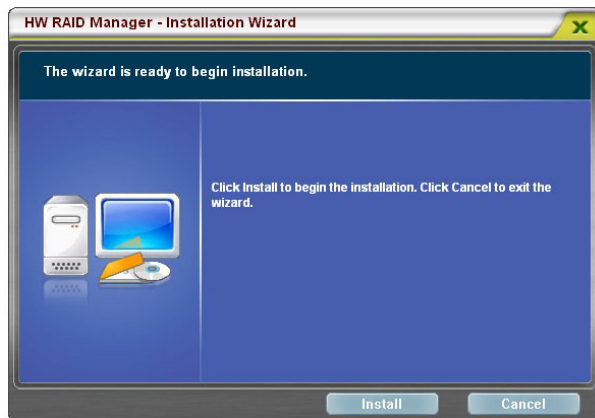

- To set the RAID mode with RAID Manager software, click the RAID Manager icon  to run the program, then follow the instructions on the RAID Manager dialog box to set the RAID mode by PC



#### Attention

1. "The number of HDD shown on a PC" is combination number when implemented 4X HDDs to this device.
2. When you use a combine mode, it is required to initialize the virtual disk volume. Please be sure that you have backup all your old data as this action will erase the data in the HDDs.
3. It is impossible to read The internal data of the HDD cannot be read during the process of the combine mode change to normal mode or change the installation position of HDD.
4. Before you change the setting, make sure that you have a backup of the data on the HDD which is working at any mode change. It is necessary to initialize the new disk volume (partition setting and Format). Please backup the data on the HDD before you change mode.



# Chapter 5 Initialization and formatting the hard disk

## 5-1 Initialization in Windows 2000 / XP/ Vista /WIN7

**CAUTION!** Partitioning and formatting a disk drive will delete the data in the HDD. We assume NO responsibility for your data lost if without a backup before your proceed Partitioning and formatting.

You must be logged on as an administrator or a member of the Administrators group in order to initialize a hard disk on the system of WINDOWS 2000/XP/VISTA/WIN7 OS

With Windows 2000/XP/VISTA/WIN7 use the “**Disk Management**” program to install your disk. This program is located in “Computer Management”.

Windows can support a disk volume at FAT32 over 32GB, but the format utility cannot format the disk volume over 32GB. If you want to format a disk volume at FAT32 mode over 32GB then you need the third party’s utility to format the disk volume. Like the “Partition Magic” from “Power Quest”.

## 5-2 Initialization in Windows ME / 98SE

Execute the “**FDISK**” program at the “MS-DOS” prompt to initialize and format the USB 4XHDD in Windows ME/ 98 SE environment.

For addition, please refer to a help file of Windows.

# Under Windows 98SE/Me you cannot format a disk volume over 32GB under Windows 98SE/Me user use FDISK (Under DOS). FDISK does not support over 137GB HDD. You need the third party’s utility to format a disk volume over 32GB on windows Me and 98.

## 5-3 An initialization procedure in Mac OS X

Execute “**Disk Utility**” to initialize an individual disk. Please initialize the disk volume with “Mac OS expansion”!

### # Normal mode Initialization

The very first time you use the USB 4X HDD in normal mode, Mac only shows the master HDD, you will need to execute the “Disk Utility” to partition the slave HDD.

# Chapter 6 How to use this product

## 6-1 Using the USB 4X HDD

In WINDOWS, hot swapping is allowed with some limits. To avoid system failure, always follow the steps below to hot UN-PLUG your USB3.0 device in Windows.

## 6-2 Basics operation



### ■ Connect to a PC

1. Start your computer and wait until the OS has been loaded.
2. Please connect the USB cable from the device to PC's USB port.
3. Connect the power cord from the USB 4X HDD device to the outlet of the AC power and turn ON the enclosure. You can see the "Power LED" is ON, and the IDE0 and IDE1 LED will be turn on to off after the HDDs is ready.

Note: Make sure the PC is turn on now otherwise the device will not turn on until the PC is started.

■Disconnect the enclosure from a PC

Before disconnecting the USB 4X HDD enclosure from the PC please follow the following steps to remove the USB cable.

	<ol style="list-style-type: none"><li>1. Click on the “Unplug or eject hardware” indicator on the task bar in computer screen display.</li><li>2. Click on the command bar “Stop USB Mass Storage -Drive(F:)” to disable the device you wish to remove.  Please! Check the drive letter to be disconnected if there are multiple devices connected</li></ol>
	<ol style="list-style-type: none"><li>3. When the screen prompt appears, read the instructions carefully.  If the system indicates that you not to remove the device, DO NOT remove the device. You should exit the present program which accesses your USB 4X HDD device and return to Step 1.</li></ol>
	<p>For Mac PC is you must drag the “USB 4X HDD” icon to the “Trash” to eject the device.</p> <p>Otherwise, a “Device Removal” warning message icon will pop up to warn you that the data might have been lost or damaged.</p>

# Chapter 7 Trouble Shooting

## ■ the RAID device is not recognized when connect to a computer. Or the RAID device does not work well.

- Check the status and connection of the power switch and the power supply outlet.
- Check whether the connection of the USB 3.0 cable is firmly connected.
- Check the jumper of each hard disk which is set correctly.
- Check if each HDD is well installed in the enclosure.
- Check device driver is installed for your OS.
- Please check the OS limitation of filing system and partition capacity vs. what you are using.

## ■ “A disk management” screen cannot start in Windows 2000/XP.

- You must be logged on as an administrator or a member of the Administrators group in order to initialize hard disk at the system of WINDOWS 2000/XP.

## ■ Transfer speed is slow even if I have access to USB.

- Check whether the USB port is working in USB3.0 mode.
- Check whether it is connected to a port of USB1.1./ 2.0 / 3.0
- If you are using a USB HUB to PC, please confirm that HUB is a USB3.0 HUB.
- When other USB device are connected to the PC at same time, it might slow down the transfer speed at the USB3.0 port; Please remove other USB device(s) from the computer.
- Check whether you use an USB cable that comes with this product.

## ■ Cannot use this product by specific software (a disk tool and backup software).

- Specific software (Note1), cannot use this product.

Please use other software whether that case uses a hard disk of the normal deployment for a PC.

Note1: About specifications of software, please check with software vender for detail.

## ■ Windows does not start when start this product was connected, Or it hangs up on PC starting process.

## ■ In Windows 98 SE and Mac OS cannot recognize HDD's which were already formatted on Windows 2000 / XP.

- There is a limitation to the filing system and partition capacity of the OS. Please confirm which OS is installed in the PC.

The following lists show you filing system of Operating System.

OS	filing system		
	NTFS	FAT32	HFS
Windows 98 SE	×	○	×
Windows ME	×	○	×
Windows 2000Pro	○	○ #1	×
Windows XP	○	○ #1	×
Mac OS	×	○ #2	○

#1. When formatting USB 4X HDD in Microsoft Windows with FAT32 format, limit of the capacity is up to 32GB. If you need to use one volume at FAT32 format over 32GB then you need third part's utility to initialize and format it.

#2. When sharing USB 4X HDD with Windows OS, it is necessary to format the USB 4X HDD within FA32 format in Windows side

■ **The volume space is less then hard disk specification, the hard disk space that it is recognized, and is displayed less than capacity of the hard disk.**

- Because calculation methods are different, there is a little it, and capacity recognized on the OS after a format is displayed than real capacity. This calculates capacity indication of a hard disk at 1GB =1000MB, but a calculation on the OS is calculated at 1GB =1024MB.

Following table shows you the different of capacity of the 1.2 TB volume size, before and after format.

HardDisk	1.2TB	1,200GB	1,200,000MB
OS	1.09TB	1,117GB	1,144,409MB

**For Technical Support**

Email: [Support@CineRAID.com](mailto:Support@CineRAID.com)

Telephone: 714-961-0800 Ext.107

FAX: 714-961-0899