

ARCHOS™ MOBILE TV & RECORDER

AV 700 TV

DVB®
Digital Video
Broadcasting



Mobile TV & Recorder / Video Player & Recorder / Music Player & Recorder / Photo Viewer / USB 2.0 Hard Drive



ARCHOS™ on the go

English Language User Manual

User Manual for ARCHOS™ AV 700 TV series

Version 1.0

Please visit our website to download the most recent manual and software for this product

Dear Customer,

ARCHOS™ thanks you for your choice of this exciting AV 700 TV product. The AV 700 TV is designed to be the companion to your home entertainment system. With the optional docking pod connected to your television, you can easily connect your AV 700 TV to the pod as desired. Optionally, you can connect it to your computer with the included USB Cable. By connecting to a computer, you get the advantage of being able to download legal music and video content from the Internet. Since it is a PlaysForSure™ device, you have a wide choice of music and video content available on the Internet. For more information about the PlaysForSure™ program, see www.playsforsure.com.

This manual will explain, in detail, the functionality of your device. The better you know how to use it, the more enjoyment you will get from it. Remember, with the AV 700 TV, you can...

- Watch Digital TV on the built-in screen, a television or video projector
- Record your favorite Digital TV programs directly onto your AV 700 TV
- Play MPEG-4 & WMV video files on the built-in screen, a television or video projector
- Record and edit MPEG-4 video files from a television or other video device (with optional accessories)
- Listen to MP3, WMA, or WAV music files or PlaysForSure™ downloaded music files
- Record music files into digital format directly from your hi-fi without a computer (with optional accessories)
- Synchronize your Windows® Media Player music and video library to your AV 700 TV
- View JPEG and BMP digital photos and create slide shows
- Copy Pictures from your digital camera via the built in host USB port
- Store .DOC, .PDF, or any type of data files – it's a portable hard drive too!

We wish you many years of enjoyment from your AV 700 TV product. Please do register your product at our website www.archos.com/register/products.html to ensure that you get access to our help line and to be informed of free software updates for your product.

Wishing you the best TV, Video, Music, and Photo experience,

The ARCHOS™ TEAM

Please take the time to read though this manual. There are many things that this device can do that you may not be aware of.

As our engineers are always updating and improving the software, your device's software may have a slightly different appearance or modified functionality than presented in this manual.

Table of Contents

1	INTRO – Buttons and Connections	7
1.1	Remote Control Description	9
2	INTRO – First Time Usage	10
2.1	Plugging in the AC Adapter	10
2.2	Turning on the AV 700 TV	10
2.3	Shutting off the AV 700 TV and Battery saving features	10
2.4	Changing the Interface Language	11
2.5	Foreign Character Sets	11
2.6	Caring for the AV 700 TV	11
2.7	Hardware Reset	12
3	TV – Watching Digital TV	13
3.1	Tuning Digital TV on the AV 700 TV	13
3.2	Watching Digital TV	16
3.3	Digital TV Action Icons	17
3.4	Watching Digital TV in your Car*	19
4	TV – Recording Digital TV	21
4.1	Recording Digital TV with the AV 700 TV	21
4.2	Setting the Scheduler	21
4.3	Viewing Digital TV recordings on your computer	22
5	VIDEO – Playing Video Files	23
5.1	Video Playback Action Icons	24
5.2	Resume Function	25
6	VIDEO – Playing Video Files from the Internet	26
6.1	Protected Internet Video content	26
6.2	Non Protected Internet Video Content	26

7	VIDEO – Recording Video Files	27
8	VIDEO – Creating MPEG-4 Video Files with your Computer	28
8.1	Installing the PC Software	29
8.2	Using MPEG-4 Translator	31
9	MUSIC – Playing Music Files	33
9.1	Button Control	34
9.2	Play Screen Icons	35
9.3	Browsing through your Music Library	36
9.4	Playing Through your Stereo System	37
9.5	Setting a Bookmark	37
9.6	The Resume Function	38
10	MUSIC – Putting Music onto your AV 700 TV	39
10.1	Synchronizing Music from Windows Media® Player (WMP) to the AV 700 TV	39
10.2	Comparison of Windows Media Player 10 to Windows Media Player 9	40
10.3	Transferring your CD collection to the AV 700 TV	41
10.4	Installing Windows Media® Player 10 (WMP10)	41
11	MUSIC – Playlists	42
11.1	Playing a Playlist	42
11.2	Creating a Playlist	42
11.3	Saving a Playlist	43
11.4	Adding songs to a Playlist while listening to Music	44
12	MUSIC – Recording Music	45
13	MUSIC – Using iTunes™ with your AV 700 TV	46
14	PHOTO – Viewing Photos	47
14.1	Viewing Photos	47
14.2	Viewing a slideshow	49
14.3	Transferring photos to your AV 700 TV	49
15	GAMES – Playing Mophun® Games	51

16 BROWSER – Using the Browser	52
16.1 Navigating the Directory Structure	53
16.2 File and Folder Operations	54
16.3 Using the Virtual Keyboard	57
17 Connecting/Disconnecting the AV 700 TV to/from your PC	58
17.1 USB Connection Type ('Hard Drive' or 'Windows Device')	58
17.2 Connecting the AV 700 TV	58
17.3 Disconnecting the AV 700 TV from your Computer	60
18 Connecting Devices to the USB Host Port	62
19 SETTINGS	63
19.1 Sound Settings	63
19.2 Play Mode Settings	64
19.3 Clock Settings	65
19.4 Display Settings	66
19.5 Appearance settings	67
19.6 Power Settings	67
19.7 System Settings	68
19.8 TV control	69
20 Updating the AV 700 TV Firmware Operating System (OS)	70
21 Replacing the battery	72
22 Recording Audio with the Optional Docking Pod/Travel Kit	73
22.1 Docking Pod Cable Connections	73
22.2 Travel Kit Cable Connections	74
22.3 Recording Procedure	75
22.4 Where is the Recording Saved?	77
22.5 Audio Editing	77
23 Recording External Video with the Optional Docking Pod/Travel Kit	79
23.1 Docking Pod Cable Connections	79

23.1.1 TV Docking Pod Description	79
23.1.2 Connecting the TV Docking Pod to your Television System - Connect & Test Method	80
23.1.3 Connection Diagram	84
23.2 Travel Kit Cable Connections	86
23.3 Recording Video Files from External Sources	87
23.4 Setting the Recording Parameters	88
23.5 Where is the Recording Saved?	90
23.6 Editing Video Files	90
23.7 Copy Protection	93
23.8 Docking Pod-Specific Options	93
23.8.1 Manually Setting the Scheduler	93
23.8.2 Automated Yahoo!® TV Recording Scheduler	95
23.8.3 Setting the Infrared Emitter Code	97
24 Troubleshooting	100
24.1 USB Connection issues	100
24.2 Charging and Power issues	101
24.3 AV 700 TV locks up (freezes operation) or Stops	101
24.4 File issues, corrupted data, formatting, and partitioning	101
25 Technical Specifications	104
26 Legal and Safety Notices	106

1 INTRO – Buttons and Connections



- a Move UP (also increases volume during media playback)
- b Move DOWN (also decreases volume during media playback)
- c Move LEFT (also plays previous song or fast reverse through song or video)
- d Move RIGHT (also plays next song or fast forward through song or video)
- e Accelerate UP – go up the list of items at high speed
- f Accelerate Down – go down the list of items at high speed
- g Infrared sensor for the remote control
- h Left and right loud speakers
- i On indicator
- j Hard drive activity indicator (read/write)
- k Battery charger indicator (blinks when battery is charged*)

7

8

- l TV out indicator (indicates that video is being sent to a connected external television)
- m Play/Enter/On – Hold for 3 seconds to switch on the device
- n Stop/Escape/Off – Hold for 3 seconds to switch off the device
- o UP action button (move up on the list of action icons)
- p SELECT action button (select the highlighted action icon)
- q DOWN action button (move down on the list of action icons)



- a Antenna connector for Digital TV
- b LCD/TV button – Hold down to switch between the LCD and an external TV display
- c USB 2.0 Full speed USB Host port – to connect compatible devices
- d Multi-connect jack* – for headphones, TV Docking Pod, and AV in/out connections
- e USB 2.0 High speed device port (USB 1.1 compatible) to connect to your computer
- f Power Connector (Use only the supplied ARCHOS™ power charger/adapter)
- g Battery latch

8

1.1 Remote Control Description

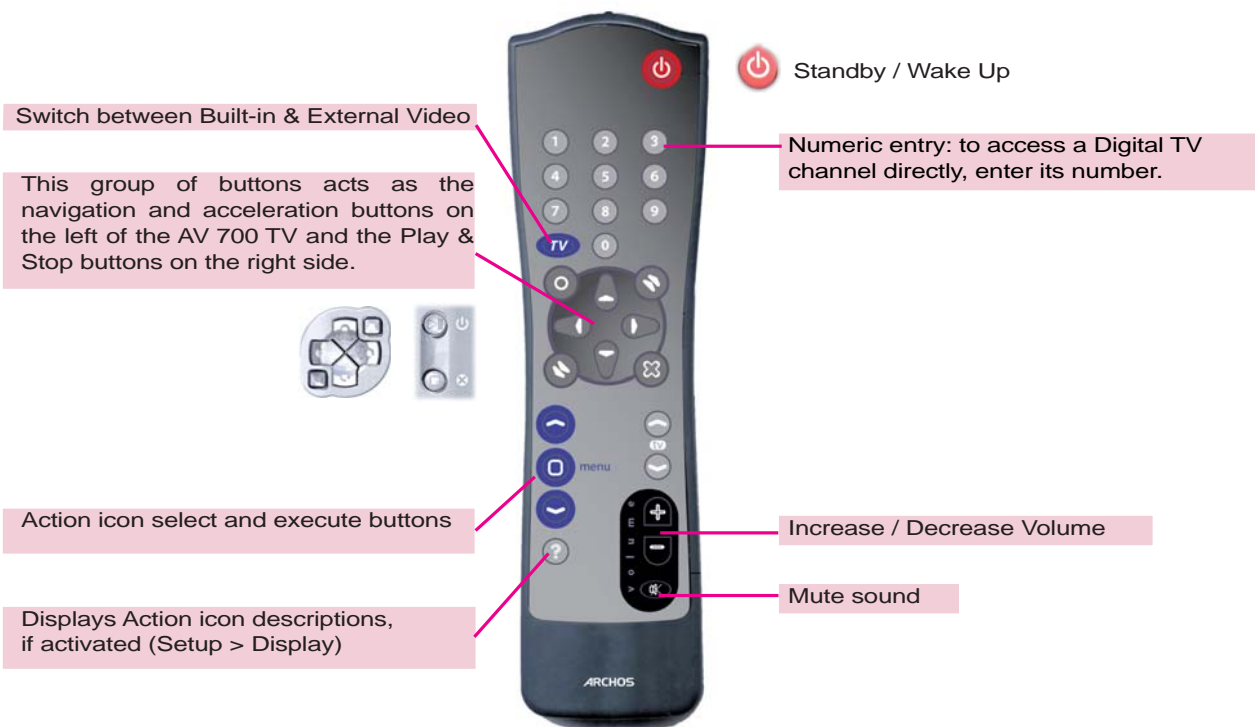

9

10

2 INTRO – First Time Usage

2.1 Plugging in the AC Adapter

- Use only the included ARCHOS™ charger/adaptor.
- You can charge the internal battery of the AV 700 TV by plugging the included adapter/charger directly into the device, or you can charge it by plugging the adapter/charger into the optional TV Docking Pod and connecting your AV 700 TV to the optional TV Docking Pod.
- Before using for the first time, charge the batteries completely. The charge indicator (CHG) light just below the navigation pad will start to blink when the battery is charged.

2.2 Turning on the AV 700 TV

- **Hold the PLAY/ON button for 3 seconds.** The green “On” indicator light will turn on. Be patient, it will take a few seconds for the operating system to boot up.
- If the unit shuts off after holding the ON button for several seconds, plug in the ARCHOS™ adapter/charger to make sure the batteries get charged.

2.3 Shutting off the AV 700 TV and Battery saving features

To shut off the unit, press and hold the STOP/ESC/OFF button for 3 seconds.

In the Power menu **[Display setup screen Power: Battery Operation]** there is a **Power Off** parameter. It is factory set to 6 minutes. Thus, if your AV 700 TV is idle for 6 minutes, it will shut itself off. This setting can be changed from one to nine minutes or to **never**.

In the Power menu **[Display setup screen Power: Battery Operation]** there is a **Backlight Off** parameter to save battery power (the lighting of the screen consumes a lot of the battery power). It is factory set to 60 seconds. That is, if the AV 700 TV is not being used, the screen will shut off in order to save battery life. To turn the screen back on, just click once on any button. See the section **Power** in the **Settings** chapter for a complete explanation.



10

2.4 Changing the Interface Language

The AV 700 TV interface can be set to English (default), French, Spanish, German, or Russian.

- Using the UP action button, highlight the **Settings** icon (showing a wrench) and then click the center SELECT action button.
- Highlight the Display icon and click the PLAY/ENTER button.
- Highlight the **Language** parameter using the UP/DOWN buttons.
- Click the RIGHT or LEFT button to choose the desired language.
- The language displayed will change immediately.
- Click on the STOP/ESC button to return to the Setup page and again to return to the main menu screen.

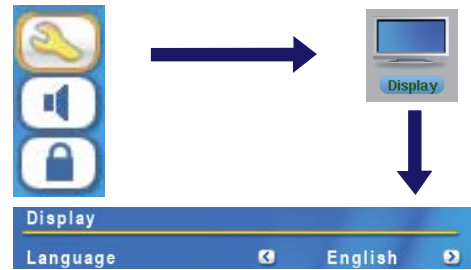

2.5 Foreign Character Sets

You have the possibility to display your file names, folder names, and music tags in various character sets (ex: Korean, Japanese, Simplified Chinese, etc.). You can find the language files *CodePage_name.4FZ* in the font folder under **/Data/Asian Fonts** on the AV 700 TV hard drive or on the ARCHOS™ website under the heading Software. If, for example, you would like to have the Korean language display, then you would copy the file *CP949.4FZ* into the folder **/system** on the AV 700 TV and shut down and restart the AV 700 TV. File names, folder names, and music tags written using the Microsoft® codepage for the language will now be displayed in that character set. Only one .4FZ can be used at a time, thus you should only put one .4FZ file into the /system folder. When an .4FZ language file is used, the interface language will be set to English.

2.6 Caring for the AV 700 TV

The ARCHOS™ Video AV 700 TV is an electronic product that needs to be treated with more care than typical consumer electronic products.

- Do not subject it to shock.
- Do not subject it to heat. Keep it ventilated by keeping it on its feet with the fold-out stand (especially when connected to a computer).
- Keep the AV 700 TV away from water and excessively humid areas.

- Keep the AV 700 TV away from high electromagnetic fields.
- Keep any connected cords to the AV 700 TV neatly arranged. This light product could fall if a cord is accidentally pulled by a child.
- Do not open up the AV 700 TV. There are no user serviceable parts inside. Opening will void your warranty.

2.7 Hardware Reset

In the event that your AV 700 TV freezes operation (due to electrostatic phenomena for example), you can actuate a hardware reset by holding down on the STOP/ESC button for 15 seconds. In normal operation, the STOP/ESC button will shut down the AV 700 TV after being held down for 3 seconds.

3 TV – Watching Digital TV

3.1 Tuning Digital TV on the AV 700 TV



Before you can use your AV 700 TV to watch Digital TV for the first time, you will need to tune it to receive the available programs in your area. You may also need to do this when you enter a different coverage area, for instance when you travel a long distance.

Setting Up and Connecting the Antennas

Your AV 700 TV comes with a set of two amplified antennas along with their cable and carrying case. Start by assembling these elements as shown in this picture.

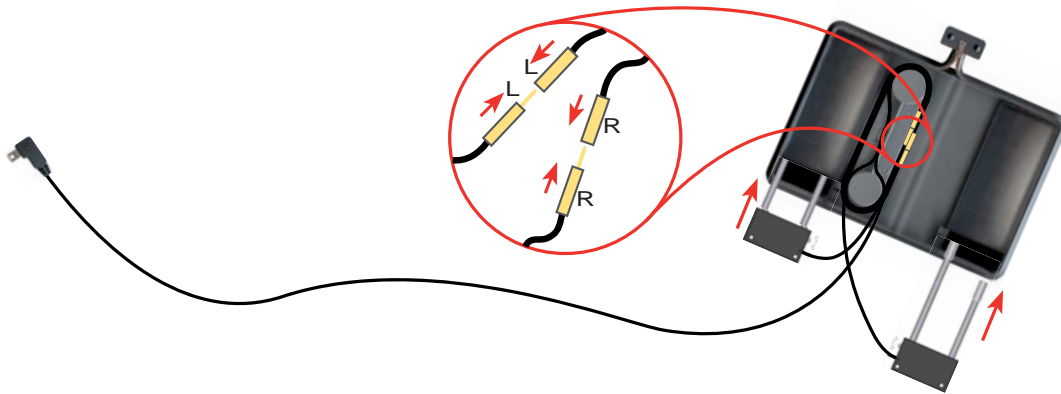

Then, connect the antennas to the antenna connector of your AV 700 TV. This port is next to the TV/LCD button on the top of the device, and is marked with this symbol: .

Attention: DO NOT connect the antennas to the 'USB A' port of the AV 700 TV!

13

14

Positioning the Antennas for Optimal Reception

You must now make sure that your antennas are in a position that allows for good reception. In most situations, you will be able to obtain a good quality signal by leaving the antennas in the opened carrying case.



- Place the supplied antennas (keeping them in their pockets) **at least 20cm/8" away from the AV 700 TV**. Try different orientations to determine which one offers the best reception (see *signal quality icon* further down).
- Deploy the antennas **away from any electromagnetic source** such as a TV or PC, and away from any metal parts (at least 30 cm/12").
- The supplied antennas are directional antennas: the most sensitive side is the front side, with the shortest element. In some areas, reception may be very poor, and you may need to take the antennas out of their pockets. In such a case, turn them **in opposite directions, as far away from each other as possible**.

Note that both of the antennas have a power LED that will light up once they are correctly plugged in.

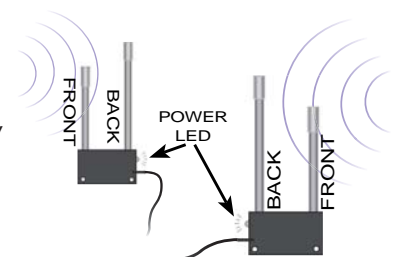

14

Note: you can use the AV 700 TV as a Digital TV tuner at home and connect the AV 700 TV to your home antenna using the supplied Antenna Adapter Cable (IMPORTANT: use only the ARCHOS™ supplied cable, and connect only to a regular aerial antenna outlet, not a cable TV service outlet).

Signal quality icon:

This icon is located in the status bar. The color and the number of bars indicate the level of quality of the received signal. The icon is split in two parts, showing reception for the left and right antennas separately. When you move the antennas, allow a few seconds before the icon reflects any change.



Please note that if you use your home antenna and the supplied Antenna Adapter Cable, it is normal that only the left side of the icon will show signal quality.

Scanning for Channels

From the Main Menu of the AV 700 TV, select the **Digital TV** menu icon and press the ENTER button. Using the action buttons, select **Digital TV Settings** and then select **Scan**. Your device will scan through the available channels (this can take a few minutes). You can now watch TV!



Note: to avoid losing these new settings the next time you scan for channels, you can save them as a preset (see *Digital TV Settings* in section 3.3 - *Digital TV Action Icons*).

3.2 Watching Digital TV

To watch Digital TV, simply select the Digital TV menu icon on the main screen and press the ENTER button. You can then browse through the available channels by using the LEFT and RIGHT buttons, as shown here:

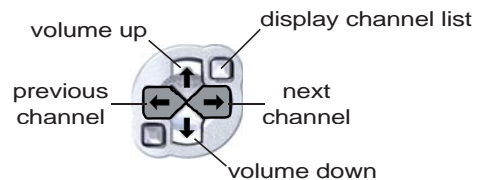

When you change channels, an information screen about the current program and the following program will be shown for a few seconds, as shown in this picture.

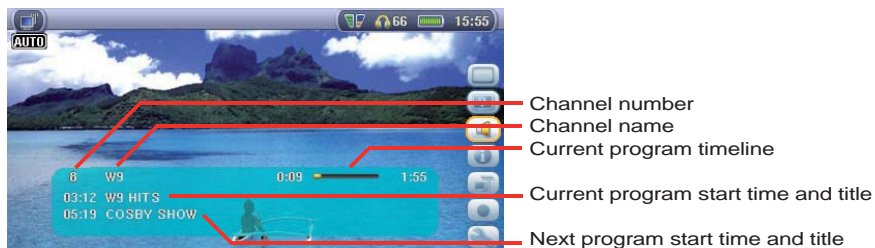

Channel List

Press either of the acceleration buttons to display the list of available channels. You can then use the UP/DOWN buttons to select a channel and press the ENTER button to jump directly to the highlighted channel.

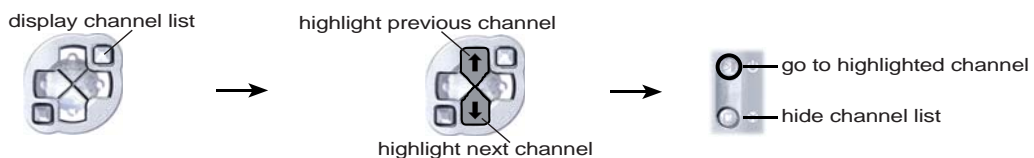

Alternatively, you can also go directly to a channel by typing its number on the supplied **remote control**.

3.3 Digital TV Action Icons

Hide Text Overlay



Select this icon to shut off the On Screen Display (the status bar, action icons and other overlaid informational graphics).

Video Format



Change the way the image is displayed on the built-in LCD screen of your AV 700 TV or on your TV:

Auto

Adjusts the video size to best adapt to the built-in screen or television.

Maximized Image

Enlarge the image to fill the screen.

Original Picture

The entire picture will always be seen on the TV and the built-in screen, no cutting.

Built-in speaker on/off



Turn on or off the built-in loudspeakers.

Current Program Info



Information will be displayed on your screen about the program you're viewing, its duration, and potentially other programming information. Note that this information is provided by the TV stations themselves and may not always be available.

17

Digital TV Settings



This menu allows you to manage the Digital TV channels:

Preset 1-5

selecting one of these presets will change the set of currently available channels to ones you have previously preset.

Scan

will search for available channels (see section Tuning Digital TV on the AV 700 TV).

Save

saves the current set of channels as a preset. Use this option just after scanning if you have traveled and want to save the local Digital TV settings as preset 1, 2, 3, 4 or 5.

Sort

will open the list of current channels and allow you to sort them to a different order and to delete the ones that you don't want to keep.

- Use the UP/DOWN buttons to highlight a channel number, then the RIGHT button to highlight the channel name.
- The UP/DOWN buttons will then allow you to move the channel to a different position.
- To delete a channel, highlight its name and press the STOP button.
- Press the LEFT button to go back to highlighting a channel number.
- To exit, highlight any channel number and press the STOP button.

Start Recording



This will start recording the channel you're watching (see section Recording Digital TV).

Video Settings



This will display the available settings, such as sound settings, LCD brightness, etc.

3.4 Watching Digital TV in your Car*

With the AV 700 TV, you have the possibility to watch Digital TV on the move. For best reception while moving, the supplied antennas can be taken out of their carrying case to be mounted on the supplied car antenna support systems. You will first need to assemble the car antenna support systems, clip the antennas into place and then apply the support systems to a flat and smooth surface (such as a window area that does not interfere with the driver's view).

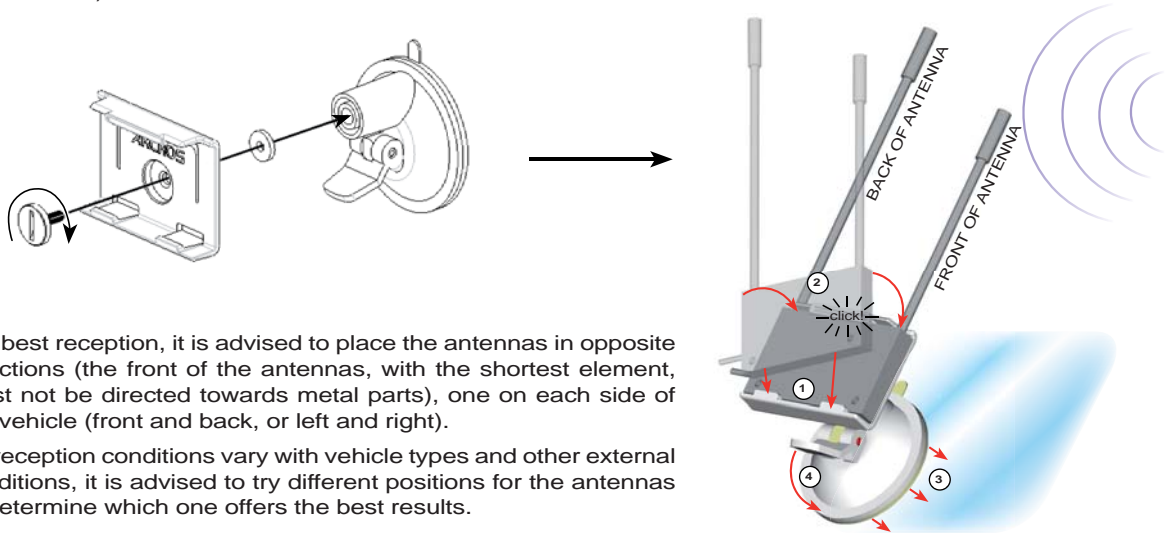

For best reception, it is advised to place the antennas in opposite directions (the front of the antennas, with the shortest element, must not be directed towards metal parts), one on each side of the vehicle (front and back, or left and right).

As reception conditions vary with vehicle types and other external conditions, it is advised to try different positions for the antennas to determine which one offers the best results.

Note: if traveling long distances, you may need to re-scan for channels from time to time.

*** Safety Notice:** for the driver and passengers' safety, and to comply with some countries' road regulations, the AV 700 TV should not be placed such that it is viewable by the driver (see additional notices and disclaimers in the legal section of this manual).

19

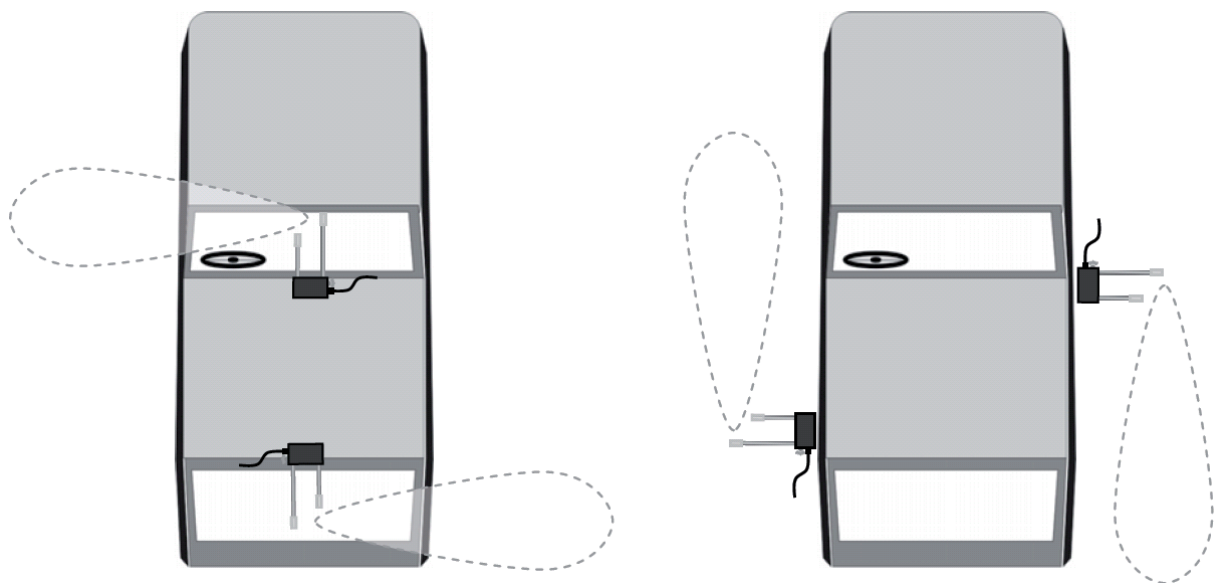

Examples of positions where the supplied antennas can be mounted on a car
(Local laws may prohibit mounting on certain windows of your vehicle)

4 TV – Recording Digital TV

4.1 Recording Digital TV with the AV 700 TV



The AV 700 TV allows you to record your favorite TV programs very easily. While you're watching TV, all you have to do is select the Start Recording action icon and the AV 700 TV will instantly start recording the program you're watching. To stop the recording, simply select the Stop Recording action icon. Note that while recording Digital TV, you will not be able to change channels.



Where is the Recording Saved?

The default location for Digital TV recordings is the folder called Video. Files recorded from Digital TV are named automatically from the program's title. To view a recording, go to the main menu and select the Video icon. You will see your recording here.

4.2 Setting the Scheduler



If you would like to make a Digital TV recording for a future date or time, you can use the scheduler. You can find it in the main menu. You can program up to twenty different recordings up to one month in advance. Once you program your dates and times of recording, press the action button OK to set them.

IMPORTANT: your AV 700 TV must be plugged in and powered by the adapter/charger. If left alone, the AV 700 TV will go on standby itself after a few minutes. At the programmed time, it will turn on and make the recording.

21

22

1. Click the Scheduler icon.
2. Select the line you want to edit using the UP and DOWN buttons, then press RIGHT to start editing.
3. Set each line with the desired date, time and channel. Make sure that the letter before the channel number is D (D stands for Digital TV and A stands for Analog recording - see section 23.8 of the full manual about using the scheduler for Analog recordings with the optional TV Docking Pod).
4. Click on the save icon to save the program. Click on the STOP/ESC button to return to the previous screen.
5. Make sure the adapter/charger is connected to the device. Set the AV 700 TV to Standby (red 'standby' button on remote control) or go back to the main menu screen and allow it to automatically (after a couple minutes of inactivity) go into standby mode.

Notes about setting the Scheduler:

- The scheduler automatically reorganizes the recording events chronologically.
- In order for a scheduled recording to start, you must leave the AV 700 TV in the main menu screen or set it to standby mode (press Standby button on remote control). That is, if you are listening to music, watching a video, or looking at photos on your AV 700 TV, it will not interrupt you in order to go make the scheduled recording.
- When the AV 700 TV user interface is in English, the Date format is set to Month/Day.
- If the end time is earlier than the start time, then it is assumed that you start recording on the start date, and the recording ends on the following day at the end time.
- Once a scheduled recording has been made, or the date of a recording has been passed, without the recording having been made (the AV 700 TV was not in Standby mode), the schedule entry will be erased from the scheduler.
- Some recordings can create files that are larger than 2 gigabytes (GB) each. The AV 700 TV will create multiple files in order to make long recordings.

4.3 Viewing Digital TV recordings on your computer

If you want to view your Digital TV recordings on your computer, you will have to install software that can read videos in MPEG-2 TS format (.TS extension). One possibility is the VLC Player (www.videolan.org).

5 VIDEO – Playing Video Files



Click on the **Video** icon in the main menu, highlight the desired video file, and then click on PLAY/GO. The thumbnail images on the right side will show you a frame from the highlighted video file (center) as well as a frame from the file above and the file below the highlighted one. By clicking on the Video icon in the main menu, you will enter into a 'video only' mode. Other playable file types, for example music files, that may be in this folder are only listed if you enter the folder via the Browser.



To watch your videos on a television, you must hold down the LCD/TV button for two seconds (or click on the **TV** button on the remote control). The AV 700 TV screen will go black and the video will be sent out to your connected television. Switch your television to auxiliary video input (often found just below channel 1 – sometimes called L1 or L2). If you don't see a clear color image, you may have to set your AV 700 TV to your local television standard (NTSC-North America or PAL-Europe) in / **Display** from the main menu.

Button controls while playing a video file

Vol +	Increase volume
Vol -	Decrease volume
Rew.	Fast Rewind
FF	Fast Forward
HSR	High speed reverse
HSA	High speed advance
>	Play/Pause
X	Stop

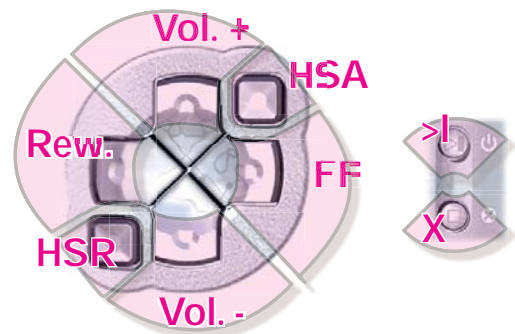

23

Video Browser Action Icons



Hide the Thumbnails



Reset thumbnails. The thumbnail images on the right side of the screen will be reset to their original default setting.

5.1 Video Playback Action Icons

While a video file is playing, click on the Select action button. The action icons on the right of the screen allow you to make video adjustments to your personal taste.

Play & Sound Settings



Use this setting if you would like to have the video files play one after the other, or just play one and stop. You can also adjust the sound settings and the amount of time the On Screen Display (OSD) information remains on the screen when you start a video file.

Built-in Speakers



Turn on or off the built-in loud speakers.

Slow Motion



Put the video into slow-motion view. You can cycle through the values Normal, $\frac{1}{2}$, $\frac{1}{4}$, and $\frac{1}{8}$ speed. The sound is muted when in slow motion. While in slow mode and paused, you can step image per image with the RIGHT button.

Set Screen Format



Video files come in various aspect ratios. That is, they can be TV sized (almost a square image), or in cinema size (much longer than high). To change the screen to your personal tastes, the following screen format options are available.

Auto Format	Default mode. Adjusts the video size to best adapt to the built-in screen or television.
Maximized Image	Enlarge the image to fill the screen (LCD or TV). Sides may get slightly cut in this mode.
Full Picture Format	The entire picture will always be seen on the television and the built-in screen. No cutting.

Set a Book mark

If you are watching a video and would like to place a bookmark in it in order to continue from this point at another time, you can use the Bookmark function. Highlight the icon and click on the Select action button. This will set a bookmark in the video file at the current position. You can only set one bookmark per file. When you look at the file in your browser, it will have a yellow check mark on its icon indicating that this file has a bookmark set within it. You can have a maximum of 16 files book-marked. Setting more bookmarks will then start to erase the oldest bookmarks. The next time you play this video file, you will be presented with three options:

Resume	Start playing from the book-marked position.
Ignore	Keep the bookmark but start playing from the very beginning.
Clear	Clear the bookmark from this file and start playing from the very beginning.

Save as Thumbnail



Save the current image on the screen as the video file's thumbnail in the Video browser view.

On Screen Display (OSD) off



Select this icon to shut off the On Screen Display (the status bar, action icons, and other overlaid informational graphics).

5.2 Resume Function

When you turn on your AV 700 TV you may notice that the icon which is highlighted on the main screen is not the **Video** icon but rather the **Resume** icon. This icon is highlighted when the AV 700 TV can resume the last played audio or video file.



25

6 VIDEO – Playing Video Files from the Internet



When using Windows Media® Player 10, you will have the advantage of being able to download protected video content from the Internet. When you see the PlaysForSure™ symbol on a web site for Windows® Portable Media Center (PMC)*, then these protected downloads will be playable on your AV 700 TV.

6.1 Protected Internet Video content

If you check the PlaysForSure™ website (www.playsforsure.com) you will find web retailers who offer rental, subscription, or purchasable video content. Remember, web sites must carry the PlaysForSure™ symbol in order for their videos to play on the AV 700 TV.

6.2 Non Protected Internet Video Content

The AV 700 TV plays .AVI files that are encoded in MPEG-4 format. It can play such video files at a maximum size of 720 x 576 pixels (25 frames/second). It can also play .WMV files (WMV9 SP) up to a maximum size of 352 x 288**. The AV 700 TV will not directly play files of type .mov, .mpg, or .mpeg.

The number of encoding and compression schemes currently used to create video files is very extensive and seems to change on a weekly basis. There are so many standards and formats that it is very possible that the video file you download from the Internet will not play right away on your device. Due to certain “variations”, even when video files are formatted in “MPEG-4” they may not play right away.

If you have some video files that do not play directly on your AV 700 TV, they will have to be converted first. Windows Media® Player 10 (Available only for Windows XP) will convert your video file automatically when you sync the file that is on your PC to the AV 700 TV. It will display a little message ‘converting’.

You can also use the software **MPEG-4 Translator** included on the AV 700 TV hard drive to re-encode your video files into the proper MPEG-4 SP format that the AV 700 TV can play. See the chapter **Video – creating MPEG-4 video files with your computer** for more details.

* MPEG-4: ISO standard by Moving Picture Experts Group ; AVI: audio/video file container by Microsoft . MPEG-4 SP with B-frames AVI up to 704x480@30f/s NTSC or 720x576@25f/s PAL.

** Microsoft WMV9 SP up to 352x288@30f/s and 800 kb/s ; supports WM DRM.

7 VIDEO – Recording Video Files

It is possible to record external video with your AV 700 TV. To do so, you will need the optional **Docking Pod**, which will give you a permanent and instant connection to your home entertainment system and allow you to **record from your satellite receiver, cable box, VCR or Camcorder** directly onto your AV 700 TV device.

If you want to make recordings from a place other than where your pod is connected, then you can purchase the **AV Travel Kit** to bring along with your ARCHOS™ device and record from any other audio or video source.

See the chapter **Recording External Video with the Optional Docking Pod/Travel Kit** for instructions on how to record video.



Docking Pod



AV Travel Kit

These optional devices can be purchased from the ARCHOS™ website: www.archos.com.

27

8 VIDEO – Creating MPEG-4 Video Files with your Computer

How to create an MPEG-4 video file

Video files that come from your digital camcorder, sent to you via e-mail, or which are freely available on the Internet are encoded in many different ways. If not already in the proper MPEG-4 Simple Profile or WMV9 Simple Profile format, a transformation operation must be done in order that these video files can be played by the AV 700 TV. This transformation process is called re-encoding.

There are basically two ways to do this; 1) Use the Synchronize button in Windows Media® Player 10 or 2) Use the PC tools which are available on the AV 700 TV's hard drive. The first method is very simple and merely requires that you synchronize a video file in your Media Player library to your AV 700 TV. You do not have much control in this converting process though and Windows Media® Player determines which video types it will and will not re-encode. The second method, although it requires some learning, will allow you to have much more control over the final quality of the re-encoded (converted) video file. It is described below. There are other tools available on the Internet, some free and some for sale, that can also convert your video files into the appropriate MPEG-4 video file format for the AV 700 TV. See the web site www.mpegmobile.com for a list of a few of them.

PC Tools

The AV 700 TV is delivered with two Windows® based programs that allow you to create MPEG-4 Simple Profile .AVI video files. They are the MPEG-4 Translator and Virtual Dub™. The MPEG-4 Translator will call the Virtual Dub program and give it the correct parameters to encode your video from its original format, .avi or .mpeg (mpeg 1), and then encode it into an MPEG-4 SP .AVI file. The file will be scaled in order to be played back properly.

8.1 Installing the PC Software

If your video file is not an MPEG-4 Simple Profile .avi file of the proper size, you will need to re-encode it using the following utilities. For the AV 700 TV, you will need to create an AVI file that is MPEG-4 Simple Profile with a resolution up to 720 x 576 (depending on frame rate) and a sound track that is stereo MP3 or WAV. In actuality, in all cases, a resolution beyond 640x480 does not add any advantage.

MPEG-4 codec (Compression/Decompression)

In order for MPEG-4-Translator to compress the video in a file of the format MPEG-4 SP that the AV 700 TV can read, it requires an MPEG-4 codec to be installed on your computer. If you do not have the appropriate codec installed, MPEG-4 Translator will tell you on start up which codec it requires. You will be able to download it for free from the Internet.

Virtual Dub™

A utility for transcoding one video file into another. This is a general purpose transfer and cleanup utility which has many options allowing for even the most difficult video translations. When you install it with the ARCHOS™ Installation Utility, it will automatically unzip. It will prompt you to save it to C:\Program Files\VirtualDub. You should use this default directory location. Otherwise you will have to instruct the MPEG-4 Translator program where to find it. For more information on Virtual Dub™ see the website - <http://www.virtualdub.org>.

MPEG-4 Translator

This program, developed by Archos, is a "Front-end" for the Virtual Dub program. It has a simple interface which you use and it then tells Virtual Dub how to process the video file. It sets all the parameters for Virtual Dub specifically to create a video file in the right size and format to be read by the AV 700 TV. When you run it for the first time, the MPEG-4 Translator will need to locate the Virtual Dub program. If you did not install Virtual Dub in the default location, you will have to show the program where Virtual Dub is. If you forget, Windows® will give you an error when you try to launch it.

29

30

MP3 Sound Codec

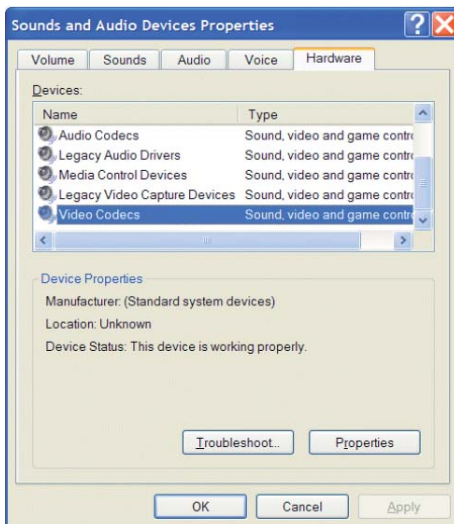

If MPEG-4 Translator detects a suitable MP3 codec on your PC, it will use it, and your video file sound track will be MP3. Otherwise, it will use the standard IMA ADPCM codec. There are MP3 encoders (usually packaged together as an encoder and decoder) available on the Web for you to download. If you choose to use the *LAME* codec, make sure that you have a version built with the *ACM* front-end. You can find other MP3 codecs on the web by using the search terms *ACM*, *MP3* and *CODEC* in your favorite web search engine. Once this MP3 codec is installed into your system, MPEG-4 Translator will be able to create final video files with MP3 sound, even if the source video file does not have an MP3 sound track.

If you are unsure what codecs (audio and/or video) have been installed on your computer, you can see the list by going to the following location.

For Windows XP, click on **Start > Settings > Control Panel > Sounds and Audio Devices Properties > Hardware**, choose **Audio Codecs**, then click on **Properties**. You will find a list here of all the audio codecs that are installed on your computer. Decoding of MPEG 2 video files is currently not supported by MPEG-4 Translator. These are usually .mpg or .mpeg format files, not the required AVI file. There are other tools found on the Internet (FlaskMPEG, Rippack, etc.) that may be downloaded in order to help you with these file types. A good starting place is the website www.digital-digest.com.

8.2 Using MPEG-4 Translator

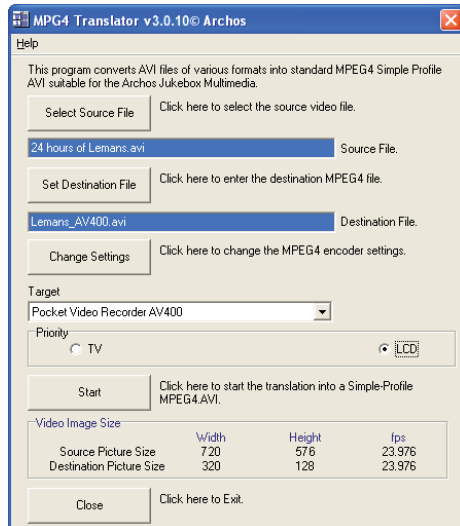

Here you see the image of the main MPEG-4 Translator program. When you first run the program, if the required codec has not been installed yet. You should download the codec and install it on your computer. If the Virtual Dub program has not been installed, you will also be notified, and you should install it (either with the ARCHOS™ Installation Utility or the Virtual Dub website). If you have placed the Virtual Dub program in a folder other than the installer default folder, it will ask you to locate the file.

Select Source & Destination Files

In this example, a source file **24 hours of Lemans.avi** has been selected as the source video. You can see on the bottom of the window its original characteristics (width 720, height 576, frame rate 30). Next, you must then tell the program where to place (Set Destination file) the newly recorded version of the file (don't worry, it will not erase the original). You should give it a new descriptive name, such as shown above **Lemans_AV 700 TV.avi**. Make sure you add the .avi extension.

Change Settings



Next, you can change the parameters (Change Settings) of the encoder to adjust the level of quality of the final image. Like MP3 music, the higher the bit rate setting is made, the higher the quality of the music, or video in this case, that you will get. However, this will also take up more space on your hard drive. A setting of 900 kbps will give you a nice looking image for viewing on a television. For near DVD quality, you can set it up to 1200 kbps.

31

32

Target & Priority

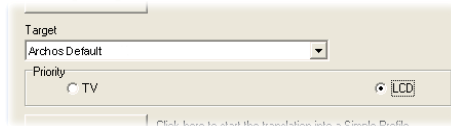

If the AV 700 TV device is not listed, select "ARCHOS™ Default". You will see a Priority box appear. This control is to allow you to select which feature of the video to be guarded. If for example you are re-encoding a video file that is 800x600 in resolution and 30 frames per second, this is beyond the maximum resolution that the AV 700 TV can play. Thus, the MPEG-4 Translator program will have to decrease the resolution. Choosing **LCD** optimizes the final video format for viewing on the built in LCD screen. Choosing the **TV** option will optimize the movie to keep the highest possible frame rate. You can see what the size and frame rate will be by looking at the **Video Image Size : Destination** parameters. When choosing **TV**, it is understood that the output will be optimized for a television, and not the built-in screen.

Start

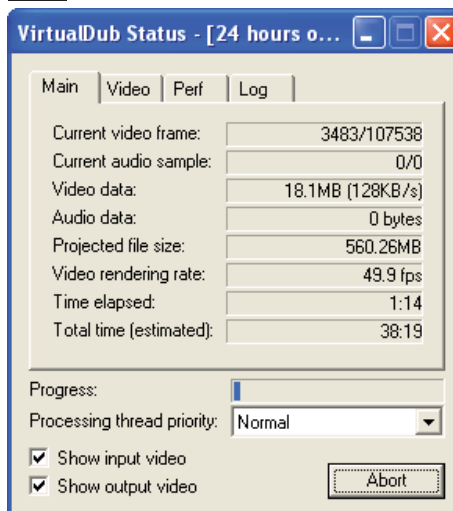

Click on Start and the program will call Virtual Dub to start processing the video. Depending on the power and speed of your computer, this could take real time (a 60 minute long video re-encoded in about 60 minutes) or much longer. As shown to the left, you will see the progress as it processes the video file. If the Start button is grayed out, it would be for one of two reasons. 1) The source file is not a true AVI file. Even if the file name ends with .avi, the internal file data determines if it is truly an AVI file. 2) The Virtual Dub program was not located when MPEG-4 Translator was started up. Close the program, restart it, and make sure you locate the Virtual Dub program.

32

9 MUSIC – Playing Music Files

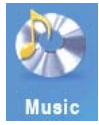

When you click on the music icon in the main screen, you will be sent directly to the ARCLibrary. From here you can choose to either browse your music by the file system (Browse hard drive) or by music characteristics (Album, Artist, title, Genre, Year). Use the LEFT, RIGHT, UP, and DOWN buttons to locate one of the factory installed music samples and then click on PLAY. If you hear nothing at first, make sure you have adjusted the volume control on the headphone cord.



1. Current Directory
2. Play Mode: One Directory
3. Status: Playing
4. Battery level
5. Volume (maximum:99)
6. Artist* or parent folder
7. Album* or current folder
8. Song title* or file name
9. Next track to be played
10. Relative location in the track
11. Elapsed, remaining, and total song time
12. Time of Day
13. Album picture*
14. File format and rec info
15. Volume level meters

**If the file contains these tag data*



9.1 Button Control

- Vol + Increase the Volume
- HSA High speed advance
- FF **Click once:** Play the next song in the folder or playlist.
Hold: Fast forward through the song.
- Rew **Click once:** Play the previous song in the folder or playlist (during first 10 seconds of song) otherwise go to the beginning of the song.
Hold: Fast reverse through the song.
- HSR High speed reverse
- Vol. - Decrease the Volume
- >| Play/pause/resume
- X Stop Song

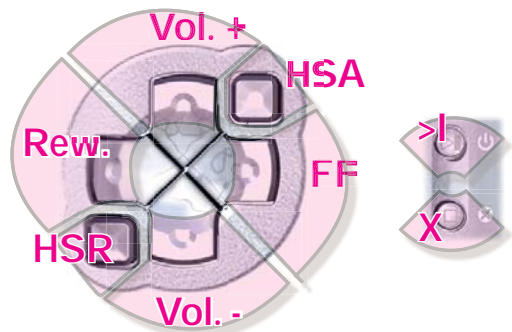





To lock the AV 700 TV buttons, select the lock action icon on the main screen and press the Select button.





The AV 700 TV will display the "locked" icon in the top left corner of the screen. Press the Select button again to unlock the buttons. You can still use the UP and DOWN buttons to change the volume.

9.2 Play Screen Icons







Status

-  Stopped
-  Blinks while Playing a track
-  Current track is paused
-  Recording a track

Play Order

-  (no icon) Play once
-  Repeat playing
-  Shuffle (Random) track selection

Play Mode

-  AV 700 TV is currently playing from a Playlist
-  **Folder:** Play all tracks in the current directory
-  **All:** Play all tracks on AV 700 TV
-  **Single:** Play a single track then stop
-  **Queue:** User can queue the next track to be played *
-  **Scan:** Plays first 10 – 90 seconds of each track*

* See the PlayMode section in the Settings chapter of this manual for details.

35

36

9.3 Browsing through your Music Library

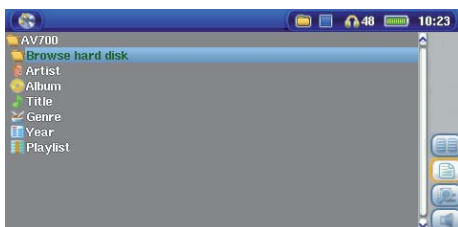

The ARCLibrary is your AV 700 TV's music library. It is a system for indexing your music by album, artist, song title, etc. When you synchronize music files from your PC using Windows Media® Player to the AV 700 TV, the ARCLibrary will get updated to include the new songs you have added. As shown in this screen capture, you can select your music by Artist, Album, Song Title, Genre, or Year.

All music files that you purchase have internal 'tags' which identify the artist, the album, and the song title. If your music files do not have internal tags (ex: WAV file format or untagged WMA or MP3 files) then the ARCLibrary will put them under the category (**Unknown**). Audio files created with the AV 700 TV from analog sources are indexed as Artist = (ARCHOS) and Album = (**Audio Recordings**).

You can reach the PlayMode settings screen from the **Setup** action icon > **PlayMode**. The play mode determines how your music is played (just the current folder of music, all music, one file, etc.). See **Playmode** in the section **Settings** above for a description of how each one works.



9.4 Playing Through your Stereo System

To play your music through your stereo system, you can use the supplied AV cable as shown below. You can also connect the optional docking pod audio outputs (red and white plugs of the cable connected to AV Out) to your stereo system inputs.

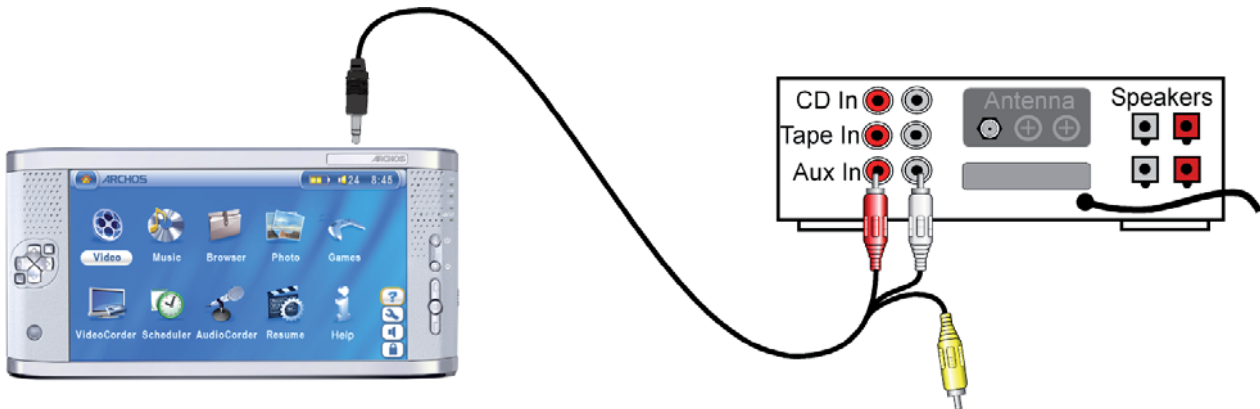

Playing through a Stereo system with an AV Cable

9.5 Setting a Bookmark



If you are listening to a song, or perhaps a long recording, and would like to place a bookmark in it in order to pick up from this point at another time, you can use the Bookmark function. Simply select the **Set Bookmark** action icon. This will set a bookmark in the audio file at the current position. You can only set one bookmark per file. When you look at the file in your browser, it will have a yellow check mark on its icon indicating that this file has a bookmark set within it. You can have a maximum of 16 files bookmarked. Setting more bookmarks will then start to erase the oldest bookmarks. The next time you play an audio file which contains a bookmark, you will be presented with three options:

- Resume:** Start playing from the bookmarked position.
- Ignore:** Keep the bookmark but start playing from the very beginning.
- Clear:** Clear the bookmark from this file and start playing from the very beginning.

9.6 The Resume Function



When you turn on your AV 700 TV you may notice that the icon which is highlighted on the main screen is not the Browser but rather the Resume icon. This icon is highlighted when the AV 700 TV can resume the last played audio or video file.

10 MUSIC – Putting Music onto your AV 700 TV



Your Archos™ product is a certified PlaysForSure™ digital device which means that wherever you find music for sale on the Internet with this symbol, you can be certain that it will 'Play for sure' on your AV 700 TV*.

The AV 700 TV is designed to work seamlessly with Windows Media® Player (WMP) versions 9 and 10. The Windows Media® Player software is used to download digital media content from the Internet to your computer and organizing it. You will also use it to synchronize (copy) the contents of your Windows Media® Player media library to your Archos™ device. See the comparison chart below for an explanation of the different features available when running Windows Media Player 9 and 10 or check out the web site www.playsforsure.com.

*Subscription services require you to be running Windows Media® Player 10.

10.1 Synchronizing Music from Windows Media® Player (WMP) to the AV 700 TV



The Synchronize button in Windows Media® Player (WMP) is a one way 'sync' button. That is, it will add music, video, and photo files to your AV 700 TV so that you have the same digital media on your AV 700 TV as you have in your Windows Media® Player media library. Of course, you can choose to sync only certain songs, videos, or photos, or sync your entire library. On WMP10, you can click the button

Set up Sync in the **Sync** tab and then check the box labeled **Synchronize Device Automatically**. This is the auto-sync advantage of WMP10. If this box is checked, then each time you connect your AV 700 TV to your PC, Windows Media® Player will automatically start up and check to see if there are any new music, videos, or photos in your media library, and if so, will then copy them to your AV 700 TV. You also have the possibility to decide what types of media automatically sync when you connect your AV 700 TV. For example, you may only want music files to be synchronized. On the other hand, with Windows Media® Player 9, you have to tell it what you want to sync, WMP9 cannot synchronize automatically when you connect your AV 700 TV to your computer.



Note for WMP10 users: Files added to your AV 700 TV from another computer or files which are recorded from an analog source cannot be added to the Windows Media® Player Library when you connect your AV 700 TV to the computer. Songs which have been added, will however, be listed in the device's ARCLibrary.

10.2 Comparison of Windows Media Player 10 to Windows Media Player 9

Windows® Media Player 10 is only available for Windows® XP (service Pack 1) and newer operating systems. It is worth your while to upgrade to Windows® XP (home or professional) and to Windows® Media Player 10. The list below shows the advantages.

Functionality

- Auto-synchronize the WMP library to ARCHOS™ AV 700 TV on connecting to PC
- Can synchronize subscription music ('to go' services) to your AV 700 TV
- Carefree USB disconnection (no special green arrow unmount procedure)
- Will convert video files** to play on your AV 700 TV if not in correct format
- Supports protected Internet video downloads

WMP9

- no*
- no
- no
- no
- no

WMP10

- yes
- yes
- yes
- yes
- yes

PlaysForSure™ audio content



* Must use WMP9 manual sync function to copy purchased music to the AV 700 TV.

** Microsoft reserves the right to limit which video file formats it will convert with WMP10

10.3 Transferring your CD collection to the AV 700 TV



The process of transferring music from a CD into music files for your AV 700 TV is known as 'ripping'. It is actually a re-encoding process, taking the CDA (CD Audio) format and converting it to WMA or MP3 format which the AV 700 TV can read. There are many music ripping programs on the market, but ARCHOS™ recommends that you use Windows Media® Player to do it. In fact, when you place a music CD in your computer, Windows® will ask you if you would like to rip it. Depending on the power of your computer, to rip a 60 minute CD, it will take anywhere from 10 minutes to 60 minutes. Once this is done, the album will become part of your music library. Connect your AV 700 TV to your computer with the supplied USB cable. Now, you go to the Sync tab and tell Windows Media® Player to synchronize that album to your AV 700 TV. It will then transfer that album to your AV 700 TV.

Note: Some music CDs have a special copy protection system that will not allow Windows Media® Player to make music files from them.

10.4 Installing Windows Media® Player 10 (WMP10)

You must be running Windows® XP (Service Pack 1 or higher) in order to install Windows Media® Player 10. Please visit the Microsoft® Website www.playsforsure.com to download and install the very latest version.

11 MUSIC – Playlists

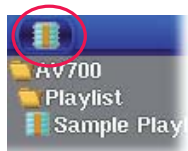

A Playlist is a list of songs that the AV 700 TV will automatically play one after the other. The AV 700 TV can load one Playlist at a time into its internal memory. You can create new Playlists, add or delete songs from a Playlist, or Save a Playlist to be used another time. There is no limit to the number of Playlists you can save on the AV 700 TV hard drive. Playlists are indicated by a special list icon (circled icon to the left).

11.1 Playing a Playlist



To play a Playlist, you simply scroll to the Playlist, such as 'Sample Playlist' shown to the left, and click on PLAY. The list of songs will be loaded into the internal memory of the AV 700 TV and then be displayed in a separate panel.

Click on PLAY and the songs will be played in the order shown. To shuffle the music entries in a random order, you can click on the **Manage Playlist** action icon, then choose **Shuffle**. If you delete a Playlist from your AV 700 TV, you are only deleting the list and not the music itself.

11.2 Creating a Playlist



To create a Playlist, select the **Open Playlist panel** action icon while you are in the Music browser. A second panel will open on the right side to display the Playlist contents. You can now start adding songs to the current Playlist. In the left panel, locate the songs you would like to add to your Playlist. Once the song is highlighted, click on the RIGHT or ENTER button or select the **Add to Playlist** action icon to add it to the Playlist. The song will be added to the Playlist and a small mark next to the music icon will be made to indicate that it is in the Playlist. Continue searching and adding songs in this manner until you are satisfied. You can select the **Add** or **Insert** action buttons

when highlighting a folder, artist, or album. All the contents of the folder, artist, or album will be added (that is, appended) or inserted before the selected song in the current Playlist.

You can jump back and forth between the browser and the Playlist by selecting the **Focus** buttons. A Playlist can have a maximum of 5000 songs. We recommend that you save your Playlists.



11.3 Saving a Playlist

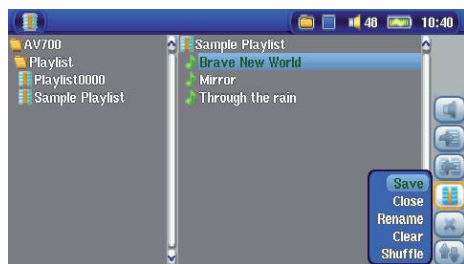

It is recommended that each time you create a Playlist, you save it to a separate folder called Playlists. These lists take very little space on your hard drive and if well named, give you easy access to your favorite songs. Go to the Playlist by selecting **Music** from the main menu and then select the **Open Playlist panel** action icon. You will then see the list of songs in the current Playlist. Use the action button to focus on the right panel, then select the **Manage Playlists** action icon, and select **Save**. **ATTENTION:** Make sure that your left panel is the **Playlists** folder because the open panel on the left is the location the AV 700 TV will be saving your Playlist to.

Save	Saves the current playlist to the folder open in the left panel. The * after the Playlist name indicates that this playlist has not been saved.
Close	Clears the Playlist and closes the Playlist panel.
Rename	Renames the current playlist.
Clear	Clears the contents of the current playlist.
Shuffle	Randomly shuffles the order of the songs in the current playlist.

The following Playlist action icons are also available

Icon: Remove Track	Will delete the highlighted song from the Playlist. It will not delete the actual song itself from your hard drive, just from the current Playlist.
Icon: Move track	Allows you to change the place in the list of the highlighted song. Click on Move and then click on UP or DOWN to move the song up or down the list. Click OK when finished.

43

Important: Once you save a Playlist it is important that you do not move or rename the actual music files since the Playlist searches in the original file location. If you need to move your music files to a different folder, you'll have to recreate your Playlist.

11.4 Adding songs to a Playlist while listening to Music

This can only be done if you have entered your **Music** folder via the Music icon and not by the general browser. To add the song you are listening to or any other song to the current Playlist, do the following:

- While playing a song, choose the action icon **Playlist Editor**. A new window will open with two panels, the hard drive contents on the left, and the Playlist on the right.
- Select the **Focus** on the left panel action icon to go to the hard drive browser panel.
- Select the song or folder of songs to add, then click PLAY or the action icon **Add to Playlist**.
- Click ESC to return to the playing screen. Remember to save your changes before closing the Playlist.

12 MUSIC – Recording Music

It is possible to record sound with your AV 700 TV. To do so, you will need the optional **Docking Pod**, which will give you a permanent and instant connection to your home entertainment system and allow you to **record from any standard analog line source (HiFi system, Boombox, CD Player, Cassette player etc.)** directly onto your AV 700 TV device.

If you want to make recordings from a place other than where your pod is connected, then you can purchase the **AV Travel Kit** to bring along with your ARCHOS™ device and record from any other audio or video source.

See the chapter **Recording Audio with the Optional Docking Pod/Travel Kit** to learn how to record sound.



Docking Pod



AV Travel Kit

These optional devices can be purchased from the ARCHOS™ website: www.archos.com.

45

46

13 MUSIC – Using iTunes™ with your AV 700 TV

The easiest way to transfer music files between a Macintosh® computer and your AV 700 TV is to use the Macintosh Finder™ to drag and drop the files to and from your Macintosh®. However, for Macintosh® users who do want to use the AV 700 TV with iTunes®, ARCHOS™ has developed a special i-Tunes® plug-in. You will find it in the folder **/Data/i-Tunes Plug-in** on the AV 700 TV hard drive or at the ARCHOS™ website. In this folder you will find a plug-in for Mac OS 9.x and another folder for Mac OS 10.x. You will also find a JPEG image illustrating where you need to copy the plug-in to. Once this is done, iTunes™ will recognize the AV 700 TV as a 'Device'. Please keep in mind the following:

Attention

Your AV 700 TV needs to be set to "Hard drive" mode (see the section **System Settings** in the **Settings** chapter or the chapter **Connecting/Disconnecting the AV 700 TV to/from your PC** on how to do this.)

- 1) Music purchased at Apple's on-line music store are copy protected with a proprietary encryption system. The ARCHOS™ device will not be able to play this purchased music or files in AAC format which you might have created. It will happily play MP3 format files without problem.
- 2) When you create your Playlists with iTunes® (you can only create Playlists from songs that have been copied to your AV 700 TV), your Macintosh® will save these Playlists to the root directory of your AV 700 TV. It will not save them to the AV 700 TV Playlists directory. It would be best to use the AV 700 TV itself to make Playlists and then save these Playlists in your Playlists folder. (See section **Creating a Playlist** in chapter **Music –Playlists**)
- 3) When you drag and drop MP3 files from your iTunes® library to your AV 700 TV, the i-Tunes® program will look at the ID3 tag information of the MP3 file, and create a folder on the root of your AV 700 TV using the name of the Artist as the folder name. Then it will take the Album name ID3 tag, and create a subfolder with that album as its name. Finally, it will take the MP3 song itself and place it into that album subfolder. Thus, although it is a clean structure of artists and albums, i-Tunes® does not follow the AV 700 TV convention of placing the music into the **Music** folder first.

46

14 PHOTO – Viewing Photos



The AV 700 TV series support the viewing of JPEG (.jpg) and Bitmap (.bmp) image formats. Progressive JPEG images are not supported. The AV 700 TV will resize the image to fit on the built-in screen or on a television screen if you choose the television output. When you are in the Photo mode, it means that only files of type JPEG or BMP will be visible in the directory. Other file types will not be visible. The three images on the right are thumbnail sized pictures of the highlighted file (center) and the picture just before and just after the highlighted file.

14.1 Viewing Photos

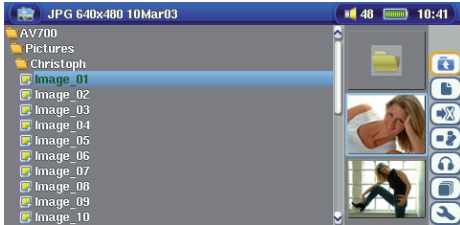

When you click Enter on a highlighted image file, the AV 700 TV will display the image in full screen mode. Displayed as a full screen image, you can rotate it, magnify it, or set it as the AV 700 TV screen background with the **Save as Wallpaper** function in the **File Management** action icon.



1 x 1 image



2 x 2 images
(Zoom out 1x)



3 x 3 images
(Zoom out 2x)



Rotate picture 90° left



Rotate picture 90° right

View previous photo



View next photo

- Move up the action icon menu to select picture option.
- Select the **Zoom in/out** action icon to change the number of photos in the carrousel view.

Magnifying Photos

Once the picture is displayed in full screen, selecting the Zoom in action icon will magnify the image up to two levels. Each successive click will magnify the picture one more level. You can use your direction buttons to move the picture around in order to see the desired magnified area. The small + signs on the bottom left of the screen indicate the level of magnification, either + or ++. Click on STOP/ESC to go back to an unmagnified view.

14.2 Viewing a slideshow



By clicking on the action icon **Play a Slideshow**, the AV 700 TV will present each picture in the current folder for a set amount of time and then go on to the next picture. You can set the amount of time that each picture stays on the screen under the action icon **Photo Browser Settings > Picture Pause**. This parameter is the number of seconds each picture displays on the screen.

14.3 Transferring photos to your AV 700 TV

The AV 700 TV is equipped with a USB host port. This port, along with the USB Host adapter cable will allow you to connect USB Mass Storage Class (MSC) devices to your AV 700 TV and transfer files from that device to your AV 700 TV. Many cameras produced today are MSC type devices. Thus you can often plug your camera directly into the AV 700 TV's USB Host port and copy your photos with the ARCHOS™ browser. If you do not have an MSC type camera, you can use a USB card reader and plug this into AV 700 TV's USB host port (via the USB host adapter cable). Finally if neither of these solutions is available to you, you can always copy the photos to your computer and then copy them from your computer to the connected AV 700 TV.

3 methods to copy photos to your AV 700 TV

- 1) Connect your Mass Storage Class camera to USB Host port (via USB host adapter cable).
- 2) Use a stand alone USB card reader with the USB host adapter cable.
- 3) Copy photos to your computer and then copy (or Sync with Windows Media® Player 10) to the AV 700 TV.

49

50



Once you plug an MSC type device into the USB host port (via the host adapter cable), the browser's left panel will show the contents of your external USB device, and the right panel will show the contents of your AV 700 TV's hard drive. Navigate to the panel which contains your photos (in this example /DCIM/113CANON). Move to the right panel (action) and navigate to the folder you would like to save your photos to (you can create a new folder if you need to by selecting the corresponding action icon). See the screen images.

Method 1

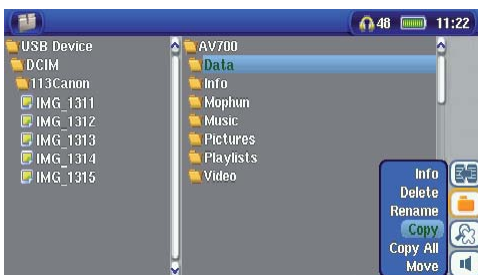

Photos from camera are shown on the left, and your AV 700 TV hard drive on the right. By using the **Select right pane** action icon, move to the right pane and choose the destination folder.

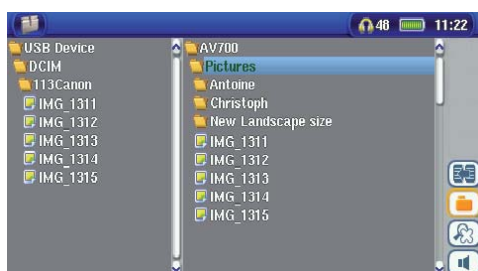

Now return to the left pane and choose the **Copy all files** action icon. Your files will be copied to your AV 700 TV, into the folder in the right pane. You can now unplug the camera from the AV 700 TV.

50

15 GAMES – Playing Mophun® Games

Please verify the availability of this feature on the ARCHOS™ website: www.archos.com.

51

52

16 BROWSER – Using the Browser



The browser is used to navigate the file system on the AV 700 TV. The file system is FAT32, the same type of file system that is found on Windows® based computers. That is, it is a hierarchical system which includes folders and subfolders. Because you will be putting hundreds of files on your AV 700 TV, it is **STRONGLY ADVISED** that keep a neat and orderly file structure. Otherwise, you will be spending time searching for files and not listening or watching them. ARCHOS™ recommends that you keep the factory created folders: Data, Music, Playlists, Video, and Pictures.



The folders **Music**, **Pictures**, and **Video** are special folders in that the icons on the main screen lead to these folders and then places you directly in that folder. If these folders are deleted or renamed, you will be taken to the root level (highest level) of the directory hierarchy.

52

16.1 Navigating the Directory Structure

To navigate the directory structure you will use:



ENTER: Open the highlighted folder (directory) or Play the highlighted file.

ESC/STOP: Go back to the main menu.



Go to the parent directory (go back up one level).

Example: Go from folder AV 700 TV/Music/Wes Burden/ to AV 700 TV/Music.

You can also use the Left navigation button to go to the parent directory.



Move the cursor up and down to the previous or next file or folder.



RIGHT: Open the currently highlighted folder.

LEFT: Go back up one level in the folder hierarchy.

16.2 File and Folder Operations

Depending on where you are in the folder system, you will have the option to manipulate files and folders. From the main menu, click on Browser. Files that the AV 700 TV cannot play will be preceded by the unknown file type icon.



Folder Operations

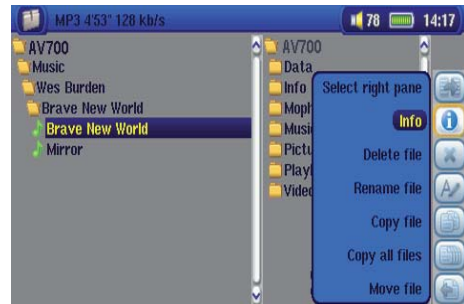

File Operations

- Info** Show file information such as song length, video length, photo size, number of kilobytes used of hard drive space, date file was made, etc.
- Create** Create a new folder inside the current folder.
- Delete** Delete the file permanently from the AV 700 TV. (Before it is deleted, the AV 700 TV will ask "Delete file: xxxxx ?". Use the action buttons to reply Yes or No. For folder, it will delete the entire contents of the folder. It will ask "Delete folder: xxxxx and all files therein?" Use the action buttons to reply Yes or No.
- Rename** Change the name of the file or folder to something new. You will be sent to the virtual keyboard (see section **Virtual Keyboard** in the **Browser chapter**) to enter the new file or folder name.
- Create** Create a new folder in the current level of the directory. You will be sent to the virtual keyboard (see section **Virtual Keyboard** in the **Browser chapter**) to enter the new folder name.

Copying and Moving Files and Folders

By using the unique ARCHOS™ double browser system, you can copy or move files from one location in the file structure to another (1000 files per folder maximum). You simply select the Open a new panel action button, and a second browser panel will open. The double browser can be used in:

- Photo View** The left panel is the connected USB device (ex: digital camera or hard drive) and the right panel the AV 700 TV hard drive contents.
- Music View** The left browser is the AV 700 TV hard drive contents and right browser the music Playlist.
- Browser View** Two panels to browse two different parts of the AV 700 TV hard drive.



In the Browser mode, you can jump between the two panels using the **Focus on the left/right panel** action icon. Where the cursor is highlighting a file or folder, that panel is the source for the copy. The destination folder will be the other panel. For example, we want to copy the file **Project info.doc** from the **AV 700 TV/Data/Files from Work** folder to the **AV 700 TV/Data/Completed projects** folder. We must start from the main screen Browser mode.

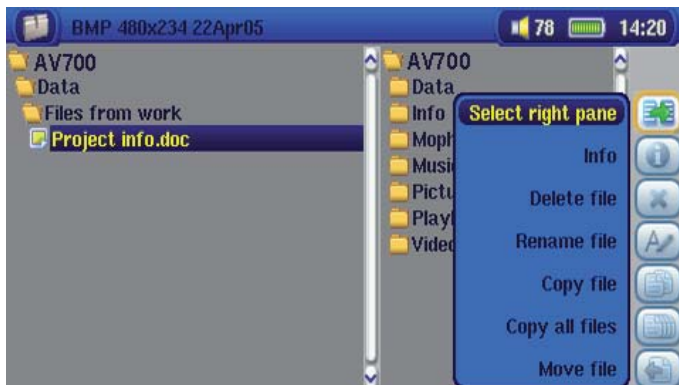

- 1) Locate and highlight the file to be copied. Using the action buttons, move to the right pane.

55



- 2) In the right pane, locate the destination folder. Then move back to the left pane.

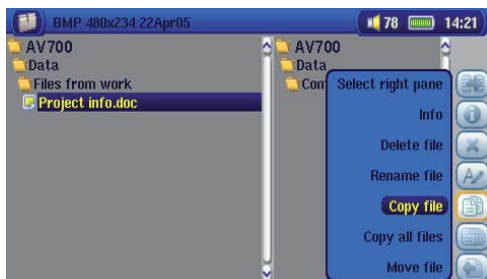

- 3) Highlight the file to be copied and select the **Copy file** action icon.



- 4) The selected file will now be copied into the destination folder.

16.3 Using the Virtual Keyboard

It is recommended that you create folders and rename files or folders from your computer when it is connected to the AV 700 TV. The computer keyboard is much easier to use. However, at times when you are not near your computer and need to enter text directly with the AV 700 TV (ex: renaming a file or creating a new folder). For this, the virtual keyboard screen will appear.

The new text that you are typing

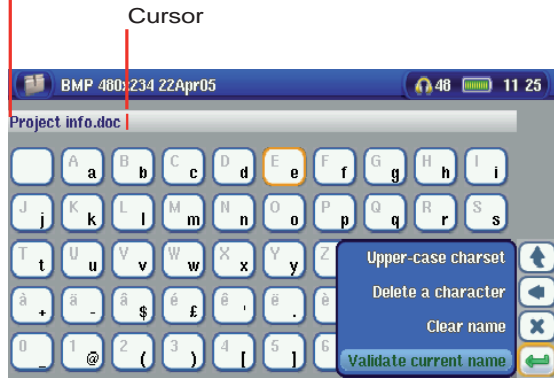

Press ENTER to enter the highlighted key/letter.

Change keyboard between upper case and lower case
 Backspace button
 Clear the entered text
 Confirmation to use the entered text.

Hold down on the LEFT or RIGHT buttons to move the cursor within the entry line.

57

17 Connecting/Disconnecting the AV 700 TV to/from your PC

Note that when the AV 700 TV is connected to a computer, it will use more energy than usual. Your battery power will be consumed at a higher rate than normal. It is normal that the AV 700 TV will get hot. If the AV 700 TV loses power while connected to your computer you could damage your directory structure and/or loose data. Thus, you should always use the AC adapter when connected to your computer. Be careful to understand the disconnection procedure also since disconnecting incorrectly can lead to data loss or computer/AV 700 TV freeze up. The AV 700 TV is not compatible with Windows® NT, Windows® 95, or Windows® 98. While connected to your computer, the AV 700 TV buttons are blocked and are no longer functional.

17.1 USB Connection Type ('Hard Drive' or 'Windows Device')



Your device comes configured as a Windows® Device and will be immediately recognized by your computer if you are running Windows® XP (with Service Pack 1 minimum) and Windows Media® Player 10. If you have another version of Windows®, not sure what version of Windows® XP you have, or if you are using a Macintosh®, then you will need to change the USB (Universal Serial Bus) Port setting on the AV 700 TV. You will do this by going to the setup action icon and then to **System** and **USB Port** and change it to **'Hard Drive'**.

17.2 Connecting the AV 700 TV

Connection order: See the sections below for your particular computer's operating system.

- 1) Connect the power adapter to the AV 700 TV.
- 2) With your computer running, plug the USB cable into your computer.
- 3) With the AV 700 TV off, plug in the other end of the USB cable to the AV 700 TV USB Device port.
- 4) Turn on the AV 700 TV. (If your computer asks to install a new driver for the new hardware, then you must unplug it and change the USB Port to Hard Drive.)

Windows® XP

Please verify* that you have Windows® XP and it is updated to at least, Service Pack 1. You must also have Windows Media® Player 10 (WMP10) installed on your computer. This way, you can take advantage of connecting it as a 'Windows Device'. Connect it to your PC as enumerated above and you can then see the AV 700 TV in Windows® Explorer and WMP10. Without Windows® XP Service Pack 1 (a free update) or Windows Media® 10, you cannot use it as a Windows® recognized 'Device' and will have to follow the instructions for Windows® ME & 2000 below.

* Right-click on 'My Computer' select 'Properties', and then look in the tab labeled 'General'. It should say "Service Pack 1" or higher.

Windows® ME and 2000

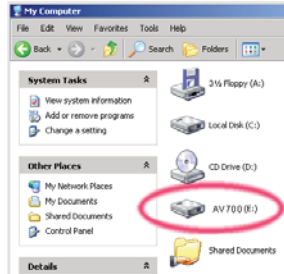

Attention: Before connecting the AV 700 TV to your computer with the USB cable, go to the setup action icon and then to System and USB Port and change it to 'Hard Drive'.

When connected to your computer, the AV 700 TV will be recognized as an external Hard Drive and display automatically within a few seconds of being connected. You will see a new drive letter, such as E: in My Computer called AV 700 TV. You can now use the hard drive called AV 700 TV like any other external hard drive. Simply access it using Windows® Explorer to drag and drop files to and from the AV 700 TV's hard drive.

Macintosh™ OS X



If you have OS X, you must update to version 10.2.4 or newer. You must also change the AV 700 TV's USB Port setting to 'Hard Drive'. From the main menu, go to the setup action icon and then to **System** and **USB Port** and change it to 'Hard Drive'.

You will now simply plug the AV 700 TV into your Macintosh® as enumerated above, and within a few seconds, the AV 700 TV will be recognized as a mass storage device (Hard Drive) and mount on the desktop. You can now use the hard drive called AV 700 TV like any other external hard drive.

59

60

17.3 Disconnecting the AV 700 TV from your Computer

Windows Device Mode



If the AV 700 TV is connected to your computer as a Windows Device, verify that no data is being transferred between your AV 700 TV and your computer (the HDD light on your AV 700 TV is not flickering). You can now safely unplug the USB cable from your AV 700 TV and/or computer.

Hard Drive Mode



If the AV 700 TV is connected to your computer as a hard drive, **DO NOT SIMPLY PULL OUT THE USB CABLE AT ANY TIME!**

WARNING: You must properly remove (unmount) your AV 700 TV from the computer before disconnecting the USB cable to avoid loss of data or freezing the computer and/or the AV 700 TV.

Hard Drive Mode & Windows®

To safely disconnect the AV 700 TV hard drive, click on the system tray remove icon (green arrow as shown below) and follow the instructions. Wait until you get a message saying that you can safely unplug the device before disconnecting the USB cable.

1. The safe remove icon is in the system tray next to the clock.



Windows® XP



Windows® 2000 & Windows® ME

2. Click on the icon to eject (unmount) the AV 700 TV from the computer and select the 'Safely remove'



3. There will be a message indicating that it is now safe to disconnect the AV 700 TV. You can now safely unplug the USB cable from your AV 700 TV and/or computer.



Hard Drive Mode & Macintosh®



Drag the AV 700 TV hard drive icon towards the trashcan, the trashcan will become a big arrow as shown in the screen shot to the left. Drop the hard drive icon onto the arrow. The hard drive icon will disappear from the desktop. You can now safely unplug the USB cable from your AV 700 TV and/or computer.

18 Connecting Devices to the USB Host Port

Thanks to the USB Host port, you can connect USB Mass Storage Class (MSC) devices such as many digital cameras and external hard drives in order to transfer pictures or data to your AV 700 TV. Check your manufacturer's information to find out whether your device is an MSC device. Non Mass Storage Class devices such as printers, Ethernet adapters, mice, keyboards, etc. are not supported. To connect an MSC device, use the included short USB host adapter.



If your camera follows the Mass Storage Class (MSC) standard for USB connection, then your camera will show up in the file browser as the folder **/External USB**. If you look in this folder you will see your photos or files. See the chapter on the **File Browser** for instructions on how to copy files.

19 SETTINGS

From the main screen, select the **Settings** action icon to reveal the menu items for various settings.

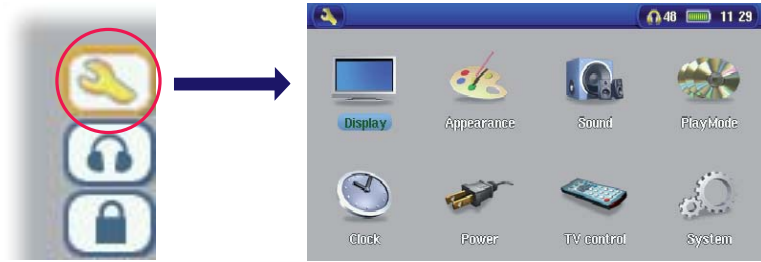

19.1 Sound Settings



If you would like to customize the sound quality, you can adjust the Bass, Treble, and other audio settings to suit your particular taste. Normally you will do this while listening to music so that you can hear the changes you make. Simply click on the **Audio Setup** action icon while listening to music.

- Once in the Settings screen, move over to the **Sound** icon and click again on ENTER. Use LEFT and RIGHT buttons to change a parameter's value. You will hear these changes instantly.
- Use the UP and DOWN buttons to select different parameters.
- Click on STOP/ESC when finished. You will return to the Setup screen.
- Click on STOP/ESC again and you will return to the music playing screen.



63

The Sound Parameters

Parameter	Description
Volume	0 – 99
Bass	10 levels. Decreases or Increases the low frequencies.
Treble	10 levels. Decreases or Increases the high frequencies.
Balance	10 levels. Favors the right or left channel of the Stereo signal.
Bass Boost	10 levels. Increases the very low frequencies.
Reset button	Re-adjusts all settings to their default values.

19.2 Play Mode Settings



If you would like the AV 700 TV to play through an entire folder of songs, play songs at random (shuffle), or any of the other playing options, you can set these parameters in the PlayMode settings. Click on the **Settings** action icon from the main menu or while listening to music and then choose **PlayMode**.

Parameter	Description
Folder	Play all tracks in the current directory or current album.
All	Play all tracks on the AV 700 TV.
Single	Play a single track then stop.
Queue	While the current song is playing, select the Show ARCLibrary action button, find the next song you want to play, then click PLAY. This is your queued song. You can only queue one song at a time. See the Playlist section to prepare multiple songs to play. Once the current track is finished playing, your queued track will be played. If you do not queue another track at this time, the AV 700 TV will play the next song in the directory.
Scan	Each track in the directory is played for 10 - 90 seconds. This allows a quick sample of each song. If you want to play the whole song, click on the Play button during those first 15 seconds. The AV 700 TV will then revert to single directory mode and play the rest of the songs in the directory without scanning.

Repeat & Shuffle

Normal	Plays your songs one after the other and then stops after the last song.
Repeat	Continuously plays through the current set of songs (Artist, Album, folder, or Playlist).
Shuffle	Randomly play through the current set of songs (Artist, Album, folder, or Playlist).

Intro duration From 10 to 90 seconds. This is the time for which each song will be played when selecting **Scan** for **Playmode** settings.

19.3 Clock Settings

The AV 700 TV has an internal real time clock. The time of day is shown on the top right of the screen in either 24 hour or 12 hour display mode. To set it, select the **Settings** action icon then select **Clock**.

**Choose parameter****Choose value for highlighted parameter**

When finished setting the parameters, move down to the **Set** button, then click on the ENTER button. The clock time and date are now set. Click on the STOP/ESC button to go back to the main settings menu.

65

19.4 Display Settings

These settings regulate the interface language and the presentation of the screen.

**Setting****Description**

Language	The AV 700 TV can be set to English (default), French, German, Spanish, or Russian.
Action icon help	Displays the explanation or name of the action icons when moving up and down through the menu. If set to On, the first click on the SELECT action button will show the names of the icons. The second click will select the icon.
TV Standard	NTSC (USA), PAL (Europe). In order to view images or videos on an external television, select one option to send the video signal compatible with your country's television system. Countries other than European or American will use one of these two systems.
TV format	4:3 or 16:9 – the ratio at which images are displayed on your television set.
Video Output	Internal LCD or External TV. To display via the built-in LCD screen or to view the display via an external television. Holding the LCD/TV button for two seconds will also alternate between these two options. Be sure your television is selecting the correct external input.
LCD Brightness	0, 1, 2. The 3 brightness levels for the built-in LCD screen. Setting to a lower value will give you a longer battery autonomy.
LCD Stability	Use this to reduce any screen LCD screen flicker you might have. Move the setting to the left and right to get the clearest image.
When accessing the Display settings while playing a video you have an additional display option:	
Video OSD	Time for which the video On Screen Display information will be shown when the video starts playing.

66

19.5 Appearance settings

Setting	Description
Wallpaper	On, Off. When set to On, the selected picture (next item) will be displayed as the AV 700 TV screen background.
Picture name	This option will display the names of the JPEG images in the AV 700 TV's System folder that can be used for screen backgrounds (Wallpaper). You can add your own JPEG images to the System folder by dragging and dropping a JPEG file from your computer. You can also set the wallpaper within the Photo mode.
Font Outline	If your screen background is a dark color, it will be difficult to see the black text on the screen. Set Outlined font to On to have a more visible white outlined font.
Color scheme	Allows you to choose what color you would like to have for the status bar above and the screen buttons.
Cursor color	Changes the color of the cursor and its background.
Previous settings	Click this button to return to the settings last set.



19.6 Power Settings



These settings will help you to save battery power thus allowing a longer battery autonomy.

You can set the AV 700 TV to conserve power for both modes of operation (when it is powered from the battery, or when it is connected to the AC charger/adaptor (DC-Power operation)).



67

Parameter	Description
Power Off	1-9 minutes or Never. The number of minutes of user inactivity (no buttons pressed) before the AV 700 TV shuts off. During the playback of music or video files, this setting takes effect only after the files are finished playing.
Backlight Off	10-90 seconds, Never. The time of user inactivity (no buttons pressed) before the AV 700 TV turns off the screen to conserve power. During the playback of video files, this setting only takes effect once the file is finished playing.
Hard disk	10-90 seconds. The number of seconds from the time of the last file access before the AV 700 TV tells the internal hard drive to stop spinning. The longer this time is set, the more often the hard drive is turning and the quicker the response time when accessing files. However, as it is set longer, it will quickly consume your battery. Caution: This setting should only be changed by experienced users.
Standby	1-9 minutes, Never. The number of minutes of user inactivity (no buttons pressed) before the AV 700 TV goes into Standby mode. When powered by the AC charger/adaptor (or connected to a powered TV Docking Pod), the AV 700 TV will not completely shut off. It will go into Standby mode. This way, it can wake up to make a scheduled video recording.

A typical use of these settings is to set the power off, screen off, and hard disk to low values when used in battery mode. When the power adapter is plugged in, you do not need to conserve energy and thus keeping the Power on and the Backlight on makes using the AV 700 TV more agreeable. Increasing the hard disk value beyond the default may actually discharge the battery even when the Charger/adaptor is plugged in. Note also that your unit will run hotter when the backlight and hard drive are on for long periods of time.



19.7 System Settings



The System settings allow you control over the low level parameters of the AV 700 TV.



68

Parameter	Description
ARCLibrary	<p>Off: From the Music icon, you will just browse music files in the folder Music.</p> <p>On: (Only in USB Port mode 'Hard drive') Browse music via its tag characteristics but the ARCLibrary must be updated manually.</p> <p>Automatic: ARCLibrary is automatically updated when the USB cable is disconnected from your device.</p>
Update ARCLibrary	This button lets you update the ARCLibrary if you have set the parameter above to ON.
USB Port	<p>Windows Device (default), Hard drive.</p> <p> When set to Windows Device, your AV 700 TV will use the MTP (Media Transport Protocol) whenever it is connected to a Windows XP (SP1 or higher) operating system with Windows Media® Player 10 installed. It will be seen as the AV 700 TV 'Device' in Windows® Explorer. WARNING: This will not work for earlier Windows® operating systems or Macintosh® computers.</p> <p> When set to Hard Drive, your AV 700 TV will act as an external hard drive (mass storage device) when connected to a computer. Use this mode for all non-Windows® XP operating systems.</p>
Firmware Version	Displays the current version of the OS (Operating System) and DRM (Digital Rights Management) system.
Update Firmware	Used to update the AV 700 TV to a new version of the Operating System. See the chapter Updating the AV 700 TV Firmware Operating System .
Product Key	Each AV 700 TV device has a unique product key number.
Hard Disk	Displays the amount of free and used space on the AV 700 TV's hard drive. Reported number of megabytes is binary based counting (1kb=1024 bytes). Thus each reported MB represents approximately 1.05 megabytes (decimal). Formatting also takes up space.

19.8 TV control

See the section **Setting the Infrared Emitter Code** at the end of this manual for a complete explanation of when and how to use this setting with the optional TV Docking Pod.

69

20 Updating the AV 700 TV Firmware Operating System (OS)

ARCHOS™ periodically updates the Operating System™ (OS) and makes it available for free download on the ARCHOS™ website (www.archos.com). Updates to the Operating System include new features, feature improvements, and bug fixes. You should check to make sure that you are running the most recent version of the OS. To check what version you have, click on the Setup action icon and then go to **System**. You will find the most recent version of the OS and its version number at the ARCHOS™ website (www.archos.com) under the download section.

Download the Update_AV700TV.AOS file

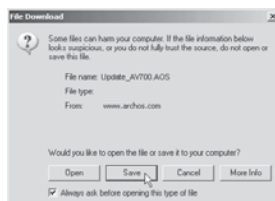

When you click on the link to download the new OS file (the file name is Update_AV700TV.AOS), your browser may warn you that the contents of the download may harm your computer. This is because the Windows® system does not know what a .AOS file is. Be assured that ARCHOS™ has made every effort to ensure that the file does not contain viruses. Click on the option **Save** to download this file to a convenient place, such as **My Documents**, in order to later copy this file to your AV 700 TV. If your AV 700 TV is connected to your PC, you can even save it directly to the AV 700 TV.

Read the History.txt File

You will also find next to the firmware download, a text file which details the list of changes from the previous version of the OS.

Copy to the AV 700 TV

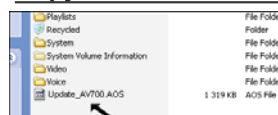

When updating your Operating System, you must keep the AC charger/adaptor plugged into the AV 700 TV so that it will not shut down due to low batteries while you are performing the update. Connect your AV 700 TV to your computer (refer to the relevant chapter if you are unsure about this), and then copy the Update_AV700TV.AOS file to the AV 700 TV.

'Hard Drive' or 'Windows Device'?

If your AV 700 TV is seen as a hard drive, then you simply need to drag the Update_AV700TV.AOS file onto this icon, and Windows® will place the file into the top most directory (root) of the AV 700 TV. It should not be placed inside any folder within your AV 700 TV. Once this file is copied, safely disconnect (refer to the chapter on Connecting/Disconnecting) the AV 700 TV from the computer.



If your AV 700 TV is seen as a Windows® Device, then you will have to open the AV 700 TV Device in Windows® Explorer and drop the Update_AV700TV.AOS into the Data folder (not the Media folder). If there is already an older version of the Update_AV700TV.AOS file on your AV 700 TV, Windows® will ask if you want to overwrite the current file. Click on Yes. Disconnect the AV 700 TV from your computer.

Activate the Update**Update Firmware**

Ensure that your AV 700 TV is still powered through the AC charger/adaptor.

Next, go to the **System** parameters from the Settings action icon and then move down to Update Firmware and click on it. The AV 700 TV will search for the .AOS file. Follow the on-screen instructions. When completed, the AV 700 TV will restart and you can go back to this screen to verify that you have updated the firmware to the new version.

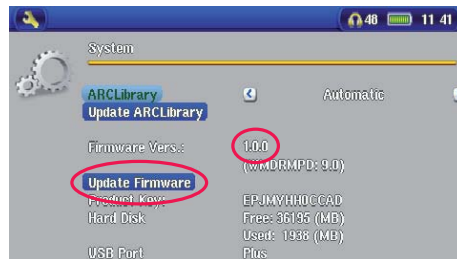

71

21 Replacing the battery

Your AV 700 TV has a removable battery. You may want to purchase a second battery for cases when you know that you will be unable to recharge your AV 700 TV before the supplied battery runs out. Refer to the chapter Settings – Power Settings for information about getting the most use from the battery.

Before removing the battery, disconnect the charger/adaptor and switch off the device. The AV 700 TV's battery is located on the left hand side on the back of the device. To take out the battery, move the slider latch downwards. You can now lift the battery from the left edge. To replace a battery, hold it with the 2 plastic notches towards the right and slide it into the battery compartment (1). Then, lower the battery into its compartment (2). Finally, remember to move the slider latch towards the top of the AV 700 TV in order to secure the battery inside its compartment (3).

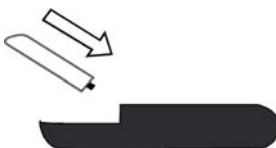

(1)



(2)

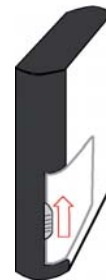

(3)

Caution: If the battery is incorrectly replaced or short-circuited, this could result in damage to the product and/or serious injuries to the user. Replace only with the same or equivalent type of battery.

22 Recording Audio with the Optional Docking Pod/Travel Kit

With the AV 700 TV series, you do not need a computer to create digital music files. It is capable of recording from any standard analog line source (ex: HiFi system, Boombox, CD Player, etc) into a standard Windows® .WAV format, either PCM (uncompressed) or ADPCM (compressed).

22.1 Docking Pod Cable Connections

If you are using the TV docking pod, then you will have to plug the Red and White connectors of the AV In cable to the output of your HiFi or other audio device that you are recording from.



73

22.2 Travel Kit Cable Connections

If you are using the optional multi-connect adapter (can be purchased from the ARCHOS™ web site) and an AV cable, you should plug the AV cable into the AV In side of the adapter, and then plug the adapter into the AV 700 TV.

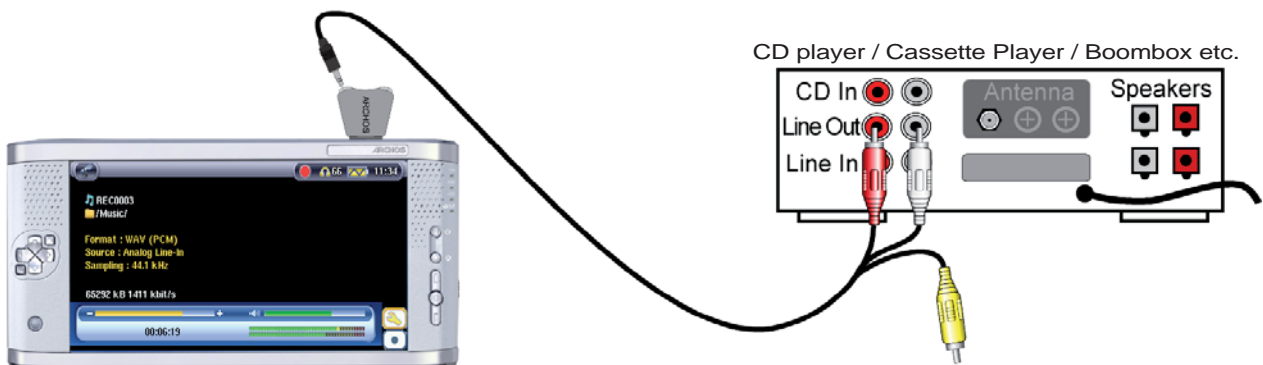

74

22.3 Recording Procedure

Before the actual audio recording begins, there is a pre-recording screen which will allow you to adjust your recording settings.

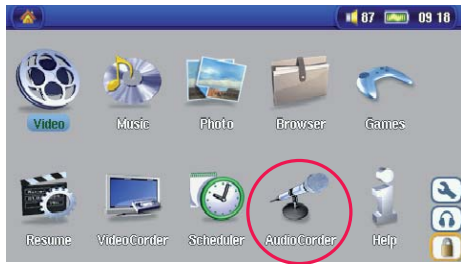

1. On the main screen, select AudioCorder then click on ENTER.

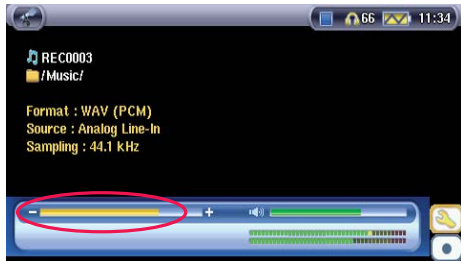

2. In the pre-recording screen, adjust the recording level* by clicking on the LEFT and RIGHT buttons. Click on the record action icon (or Enter button) to start recording. Attention, the first time recording you should adjust your Settings.

* You should try some test recordings before deciding on which recording level gives the best sound quality. Don't be tricked by the volume of the headphones which can be adjusted independently with the UP and DOWN buttons.

75

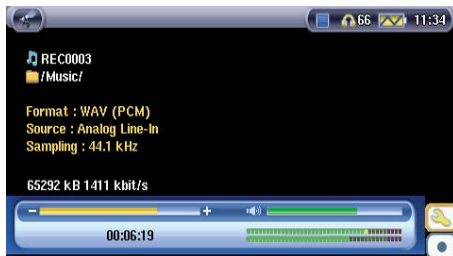

3. Click on the Settings action icon to reveal the recording parameters screen as shown above.

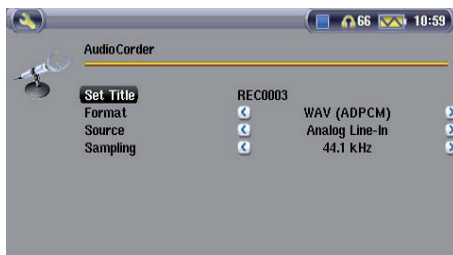

4. Once you have clicked on the Record action icon (or Enter button), you can pause the recording by clicking the Pause action icon (or Enter button) and then stop the recording by clicking on the STOP button.

You can record from any line-level audio source to the AV 700 TV. Be careful that the source audio is supplying a line level and not an amplified signal (turning down the volume on the player will work if you are using the headphone out signal of your audio device). A signal that is amplified too much will make for a terribly distorted recording.

Incremental Recording



While recording, you will notice the incremental recording action icon. This allows you to create incremental recordings. This means that the current recording stops and a new recording instantly begins. The next recording has an additional number appended to its name. Thus if you create multiple incremental recordings, you might, for example, have file names of REC0000_01, REC0000_02, etc. This is good for recording old cassettes and old vinyl records. You can click on this icon during the blank space between each song. That way, each song of the vinyl disk or audio cassette will be one single music file.

22.4 Where is the Recording Saved?

The default location for audio recordings is the folder called Music. This can be changed though. For example, you click on the Music icon in the main menu and then you choose Browse Hard Drive. Notice that there is the Launch Audiocorder action icon. Each time you use this button to start the Audiocorder application instead of the AudioCorder button on the main menu, you set the recording default location to the current folder. For example, let's say you have a folder called /Music/Vinyls/Soul. If you go to this folder and then make a recording using the action icon, you will set the default record location to this folder. Now, all your recordings you make with the Audiocorder icon will be saved in the folder /Music/Vinyls/Soul.

22.5 Audio Editing

Audio files (analog recordings only) can be modified by deleting the sections you do not wish included. If you would like to edit an audio recording, you have the possibility to cut the file down to the specific part you want to keep. In the example below, you have recorded a lecture of 33 minutes and 22 seconds in length. You would like to cut out and save just one particular important section from 12 minutes and 15 seconds to 21 minutes and 5 seconds. The diagram below illustrates the situation.

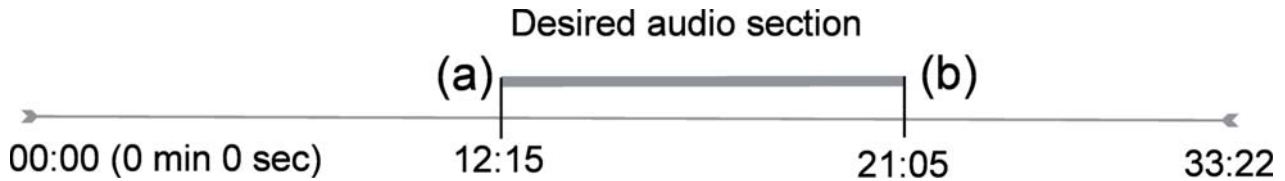

To keep just this section (cropping it), you will:

- Locate this file via Browse hard disk in the Music application.
- From the action icons, select the File Management action icon and then select Edit.
- In the edit mode, set the Cut In point (12:15 in our example). This will remove the part of the file BEFORE the desired segment.
- Now set a Cut Out point (21:05 in our example. Please note: As you have cut part of the file, this position will actually be earlier in the file now).

77

- Validate and Save the edit. The file will be saved with the word "edit" appended to the file name in the same folder as the original.
- If you do not want to save your modifications, click the STOP/ESC button and select OK.

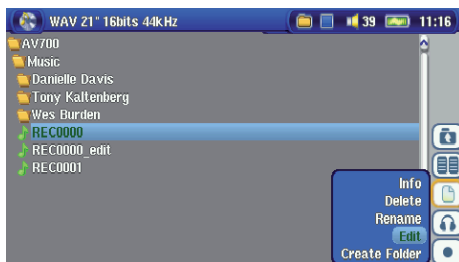

Highlight the file to edit and select the File Management action icon. Choose Edit. Only files which have been created with the AV 700 TV recording function will show Edit in the file menu. Files created from CDs or downloaded cannot be edited. Once you enter the edit mode, the audio file will play in a continuous loop so that you will be able to hear the changes to the edit as you make them.

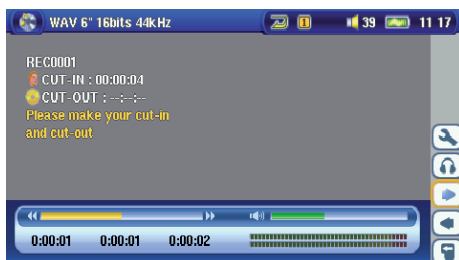

Use the fast-reverse and fast-forward buttons (LEFT/RIGHT buttons) to locate the points you want the new file to start and end. These are the Cut In and Cut Out points. Once you have set these points, you can save the edit. In this example, a new file REC0001_Edit will be made. Your original file is left untouched. You will notice that your Cut In and Cut Out times are marked just below the file name.

23 Recording External Video with the Optional Docking Pod/Travel Kit

23.1 Docking Pod Cable Connections

By installing the TV Docking Pod, you have an easy way to connect and disconnect your AV 700 TV to or from your home entertainment system. Simply connect the pod's multi-connect plug to the AV 700 TV as needed. If you have scheduled television recordings to make, then connect the AV 700 TV to the pod and let it make the recording while you are away. If you want to make TV recordings from a place other than where your pod is connected, then you can purchase the AV Travel Kit to bring along with your ARCHOS™ device and record from any other audio/video source.



23.1.1 TV Docking Pod Description



- a AV input jack – use either of the AV cables
- b AV output jack – use either of the AV cables
- c S-Video in – input (you can use a standard s-video cable (not included) for your video input)
- d Adapter connection – connect the included power adapter here
- e Infrared Emitter jack – plug in the included infrared emitter if you want the AV 700 TV to control a VCR, cable box, or sat. receiver.

79

80

23.1.2 Connecting the TV Docking Pod to your Television System - Connect & Test Method

Even if connecting audio-visual equipment is not your strong suit, by following our instructions and applying our **Connect & Test** method, you will be able to verify that your connections are correct. Refer to the connection diagram at the end of this section while reading through each step below.

1) Connection: Powering the TV Docking Pod

Plug the included adapter/charger into the jack labeled DC-in on the TV docking pod. Your docking pod must always be powered, even if you do not have your AV700 connected to it. If not powered, your regular tuner's output (VCR, cablebox, satellite receiver) will not be seen on your television.

2) Connection: Breaking your regular TV Connection

The TV docking pod is a pass-through device. That is, if you do nothing more than connect it to your VCR, Cable box, or Satellite receiver and your television, it will pass the audio and video signals through to your TV and you will notice no difference in how your television system operates. Start by disconnecting your television from its usual source (vcr, cable box, or satellite receiver).

3) Connection: Put the TV docking pod between your TV and Tuner



We will now put the TV docking pod between these two devices you just separated. Take one of the AV cables (they are identical, don't worry), and plug it into the **AV Out** jack of the TV docking pod, and plug the other end of this cable into your television (European users may need to use the included **IN** labeled scart adapter). Take the second AV cable and plug it into the **AV In** jack of the TV docking pod. The other end of this cable must now go to the video and audio output of your tuner (VCR, cable box, satellite receiver) that was previously connected to your television (European users may need to use the included **OUT** labeled scart adapter).

TEST IT: Verify that you made the correct connections.

- Turn on your television
- Turn on your video device (vcr, cable box, or satellite receiver)

80

- You should be able to use your television system as you normally do. The TV docking pod is merely passing through the video and audio to your television.
- Europe: If you don't see the video, check to make sure you used the correct SCART IN and OUT adapters.

4) Connection: Connect the AV 700 TV to the TV Docking Pod



Connect your AV 700 TV to the docking pod as shown. The AV 700 TV can be on or off when you connect it. If it is off, the act of connecting it to the docking will turn it on. If the AV 700 TV is lying flat next to the docking pod, there is a good chance that you will not be able to control it with the remote control. Thus, you should always set it up on its stand.

TEST IT: Test now to verify that it works as desired.

- Turn on the AV 700 TV and your television.
- Hold down on the TV/LCD button for 2 seconds (button located on top of the AV 700 TV).
- The screen on your AV should go black.
- You should see the AV 700 TV screen now displaying to your television.
- If not, switch your television to auxiliary input (often called L1 or L2 just below channel 1)
- Hold the TV/LCD button again to return to viewing on your AV 700 TV.

5) Connection: the S-Video In



If you would like to get a higher quality video recording, and your video recorder, cable box or other video device has an S-video output, you can connect a standard S-video cable from it to your TV docking pod. This will carry only the video signal to the pod and your AV 700 TV, not the audio. The video pass thru feature is not supported for S-Video input.

DO NOT PLUG IN BOTH THE S-VIDEO CONNECTOR AND THE STANDARD YELLOW AV IN CONNECTOR AT THE SAME TIME.

81

6) Connection: the Infrared Emitter

This is an optional connection. You will need to use this if you would like to change TV channels with the ARCHOS™ remote control or if you want to be able to make scheduled recordings. This emitter, once stuck on to your cable box, satellite receiver, or video cassette recorder, will be able to turn that device on and off and select channels while you are away. The emitter acts like the remote control for that device.



Infrared (IR) Emitter

Which device to control?

You will affix the IR Emitter to the device you normally change your TV channels with. Do you change TV channels with your video cassette recorder remote control, your cable box remote control, or your satellite receiver remote control? Which ever one of these devices changes the channel that you view, then it is on this device that you will affix the IR Emitter.

Locating the Infrared Receptor on your VCR or Cable box

First, you must locate the infrared detector on the device. This is the small dark window (looks black or deep red actually) which you point your remote control at to change the channels. We will use a video cassette recorder (vcr) as an example, but the following is true also for a cable box or satellite receiver.

Look in your device's user manual to see if it shows you where the infrared detector window is. If you find it, then jump to the next step "Connecting it to the TV docking pod".

One way to locate the infrared receptor on your VCR is to cover up various parts of the face of your VCR with your hand while changing the channels and notice at what point your VCR's remote control stops working. By covering up various parts of the face, you will stop the infrared beam from reaching the infrared receptor. Keep changing the channels with your remote control, moving your hand over various areas until you have found where the infrared receptor is.

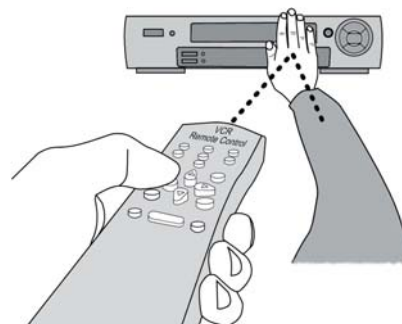

Connecting it to the TV Docking Pod



Plug the connector end of the Infrared Emitter to the far right jack on the back of the TV Docking Pod. This emitter will act as your remote control for your scheduled recordings.

Sticking it onto your device and Setting the IR Emitter code

Now that you know where the infrared receptor is, you need to set the correct infrared emitter code on your AV 700 TV and then affix the IR emitter to your device. Every VCR, cable box, and satellite receiver has a different infrared code to tell it to turn on and off and how to change channels. With the IR emitter in one hand, move it over the infrared receptor on your cable box, VCR, or satellite receiver and then set the infrared code as explained in the section **Setting the Infrared Emitter Code**. Once you get the AV 700 TV to start controlling your device by infrared signals (there are test buttons for this – see the **TV Control setting** for help), you can then peel off the white ring protecting the adhesive, and stick the IR emitter to your device. If your regular remote control for this device is sensitive to distances, you could affix the Infrared Emitter slightly to the left or right of the device's receptor so as not to impede the functioning of the regular remote control.

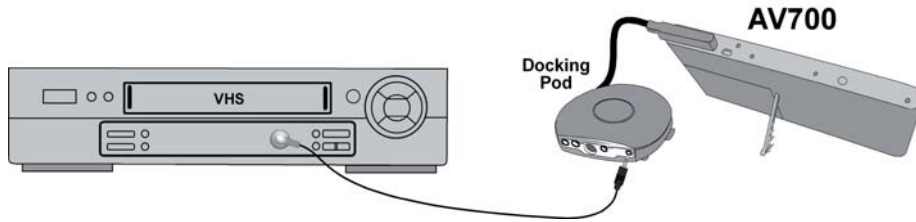

83

23.1.3 Connection Diagram

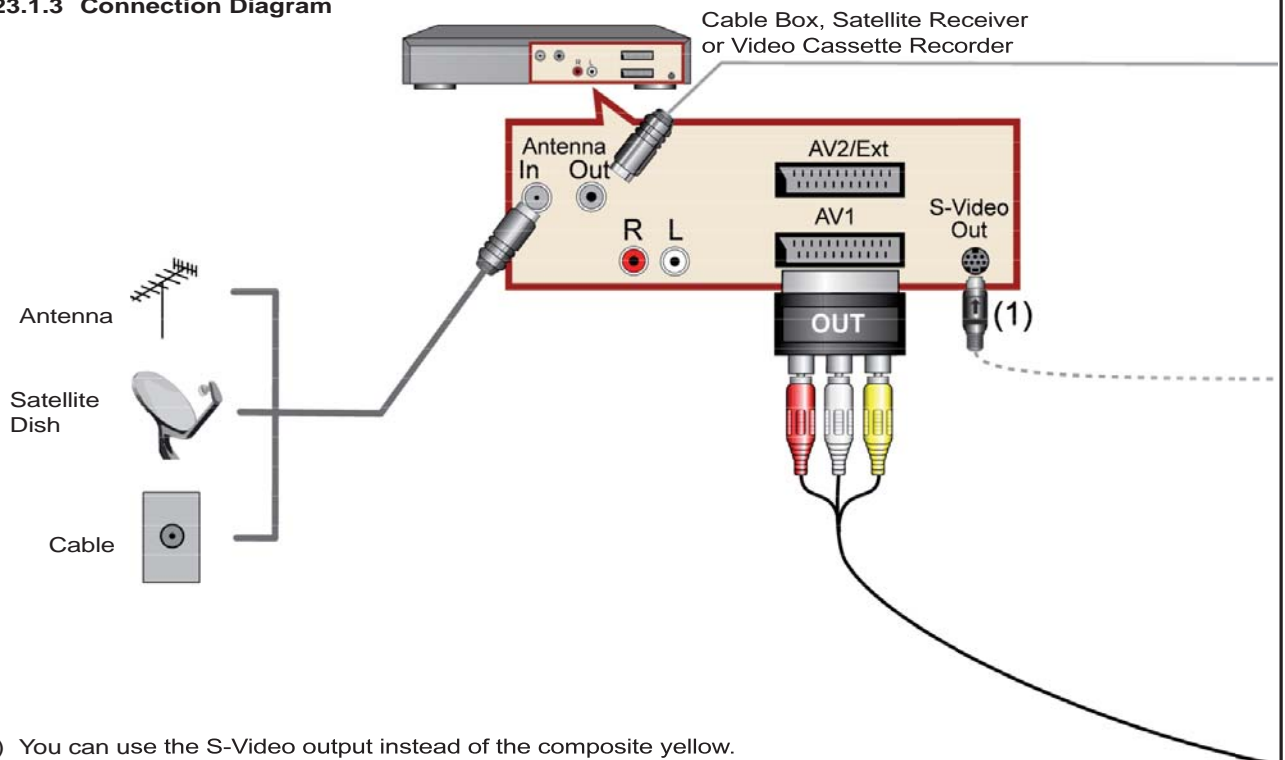

- (1) You can use the S-Video output instead of the composite yellow. You will need to purchase a standard S-Video cable for this.
- (2) See the manual section on connecting the infrared emitter.
- (3) You can use the AV connections on the front or back of your television.

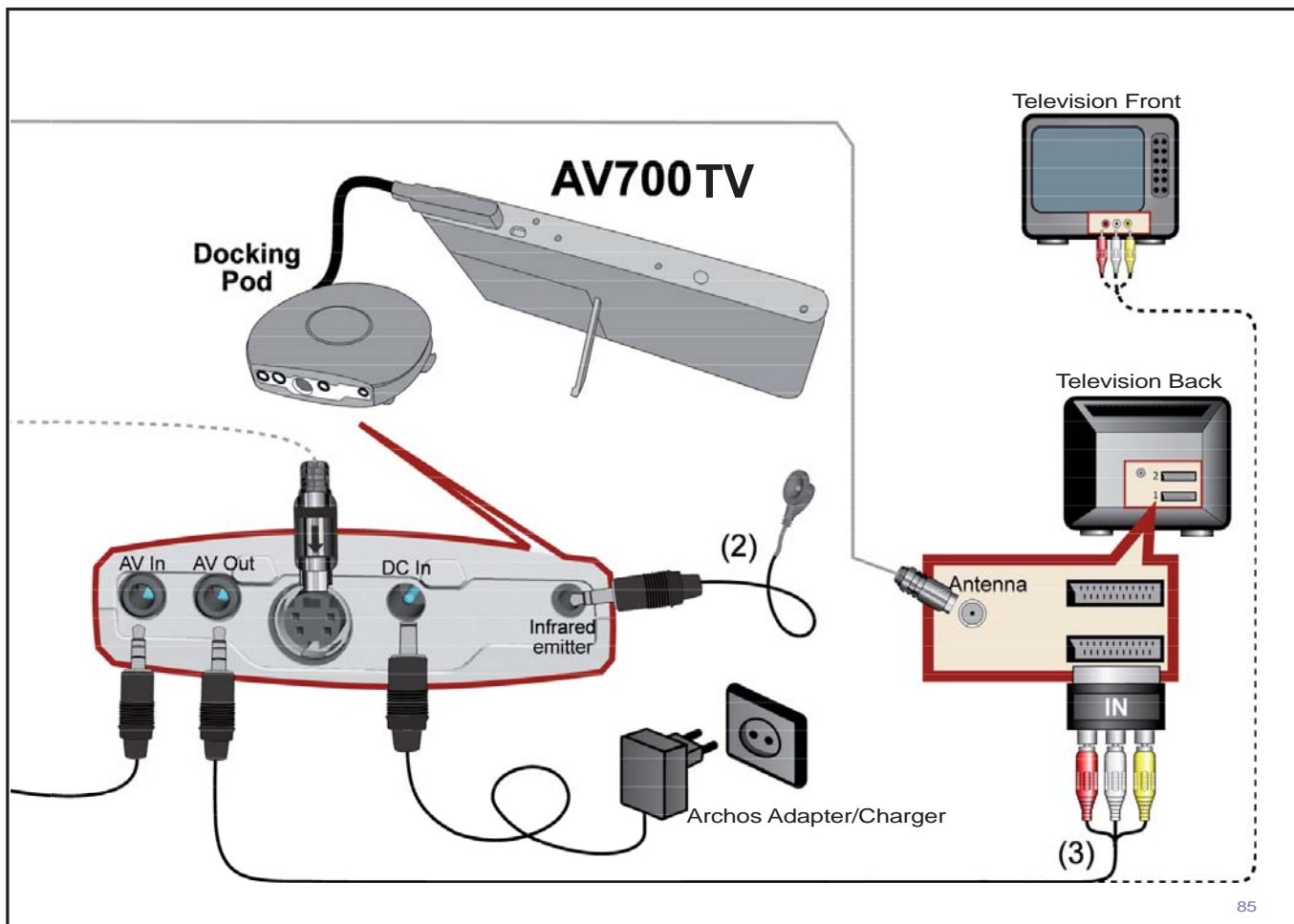

23.2 Travel Kit Cable Connections

If you are using the optional multi-connect adapter (can be purchased from the ARCHOS™ web site) and an AV cable, you should plug the AV cable into the AV In side of the adapter, and then plug the adapter into the AV 700 TV.

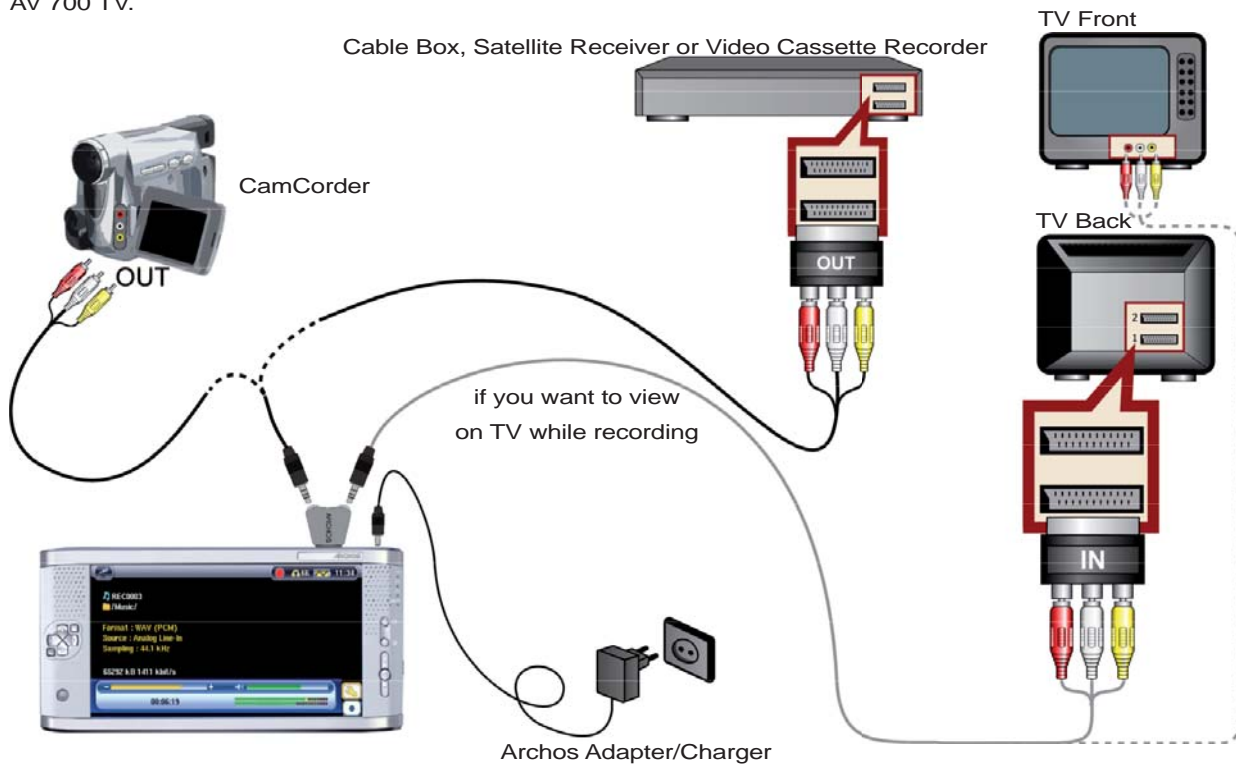

23.3 Recording Video Files from External Sources



With your optional TV docking pod properly connected to a VCR, cable box, or satellite receiver, you can make recordings from these devices. See the relevant chapter for instructions on connecting the optional TV docking pod to your television system.



Pre-record Screen

1. Select the VideoCorder action icon from the main menu screen. In the pre-record screen, you should see movement on the sound level bar indicating that sound will be recorded. Adjust the sound level by clicking the LEFT/RIGHT buttons. Before starting the recording, you can adjust the recording parameters via the Setup action icon.



Setup Parameters

2. In most situations, the video recording will work fine without your having to adjust the settings. However, by selecting the recording settings, you have access to a number of parameters that you can change before you start the recording. See the table below for descriptions.

87



During Recording

3. Click on the PLAY/PAUSE button to start the recording. While recording, you will see the length of time of the recording in the top left of the screen as well as a red "record" indicator. Click on the PLAY/PAUSE button again to pause the recording. Click on the STOP/ESC button to stop the recording. The AV 700 TV will take a few seconds to complete the proper saving of the .AVI video file.

23.4 Setting the Recording Parameters

You can set the recording parameters manually to suit your specific needs. Click the action icon in the VideoCorder's pre-recording screen.

Rename	Allows you to change the filename before the recording begins.
Auto Stop Rec	On, Off. If set to On, the AV 700 TV will stop recording after the duration set in the next line. For example, you want to record a television show for two hours but do not want to stay around for the two hours to stop the recording. A recording that you start manually will last for 2 hours. If set to Off, the recording will continue until you click on the stop button or until the entire hard drive fills up.
Duration	This is the duration of time your manual recording will last if Auto Stop Rec above is set to On.
Pre-record	This is a safety margin added to the beginning of a scheduled recording which was set via the My Yahoo!® TV scheduler of your personal Yahoo!® calendar. It affects ONLY these recordings. This is just in case the clocks between your AV 700 TV and the broadcast station are different or if the broadcast station starts earlier than expected.
Post-record	This is a safety margin added to the end of a scheduled recording which was set via the My Yahoo!® TV scheduler of your personal calendar. It affects ONLY these recordings. This is just in case the clocks between your AV 700 TV and the broadcast station are different or if the broadcast station runs overtime.

Source	Composite, S-Video, Auto. You can choose which video input you want the AV 700 TV to use. Normally, with a good video signal, you can set it to Auto, and the AV 700 TV will scan the two TV docking pod inputs to see which one is receiving video (AV In or S-Video).
Format	Auto, 4:3, 5:3, 16:9, 2.35. This is the aspect ratio of the screen that the AV 700 TV will record. You can set this manually, but in most cases you can just leave it on Auto.
Resolution	Optimal, VGA. Use this to set the resolution of the recorded image. You can leave this on Optimal. Optimal (512 x 384) will give the smoothest image quality, with the smallest file size. VGA (640 x 480) will give sharper images, which are less smooth during fast moving scenes. However, the file size is larger.
Bitrate	500 kb/s, 1000 kb/s, 1500kb/s, 2000 kb/s, 2500kb/s. Use this to set the encoding quality (similar to the idea of JPEG image quality settings). The higher the encoding rate, the higher the image quality but also more hard drive space will be used. Lower bit rates will use less hard drive space.
Sampling	32kHz, 48kHz. The sound sampling rate. The higher value gives a higher quality sound but will take up more space on the hard drive.
Brightness	Use this to increase or decrease the recorded image brightness
Contrast	Use this to increase or decrease the recorded image contrast
Saturation	Use this to de-emphasize or saturate the colors in the recorded image
Hue	Use this to change the color spectrum in the recorded image
Reset	Change the above settings to the AV 700 TV default settings

- Once you have finished changing the parameters, click Stop/escape button to return to the pre-record screen.
- Concerning the video standard, the AV 700 TV will automatically recognize whether the incoming video signal is NTSC (American), SECAM, or PAL (European). There is no need to set anything. You will see the signal type, as well as the selected aspect ratio on the top left of the pre-recording screen.
- Click the LEFT/RIGHT buttons to adjust the sound input level. Too far to the right will often give an overdriven distorted quality. Too far to the left may make for a very soft sound. Try a few recordings to get a sense of what is the best sound level. Do not let the headphone volume fool you. That can be adjusted independently with the UP/DOWN buttons.

89

- If you would like to make a recording in another folder instead of the default "Video" folder, go to the desired folder via the main Video icon, then click on the Launch Videocorder action icon.

23.5 Where is the Recording Saved?

The default location for video recordings is the folder called Video. If you click on the Video icon in the main menu, you will go to this folder.

23.6 Editing Video Files

Video files recorded using the TV Docking Pod can be modified by deleting the sections you do not wish included. The editing you can do is either cropping or cutting of particular segments of the video file. You will mark a segment of your video file, and then you will tell the AV 700 TV to delete everything except the marked segment (crop) or to delete the marked segment (cut) from the video file. These operations can be done multiple times on the same video file. Once finished, you will have the option to save the edit marks with the video or to write a new video file. If you save your file with edit marks, you can always go back and change your edits at another time. The actual video information is not deleted. On the other hand, you can write a new file which will only include the video parts that you specified in the edit session. This file will be smaller but you can never un-edit it.



Example 1: You have recorded a music video program and would like to keep one single music presentation. The rest of the television recording you do not care to keep. In this case, you would set a Start mark (a) at the beginning of the desired segment, and an End mark (b) at the end of the desired segment. You would then choose Keep selected part action icon which would then delete everything except the designated section.

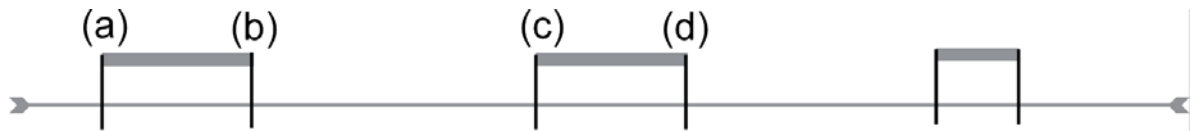

Example 2: You have recorded a television program but would like to remove certain sections before the program started, parts during the program, and the program afterwards because you had recorded a little extra. In this case, you would make a Start mark (a) at time 00:00 and then forward to the end of what you want to delete and make your End mark (b), and choose Remove selected part. This part of the video recording will now be cut out. Fast-forward to the center of the recording and make a Start Mark (c) where the section that you want to delete begins, and make an End mark (d) when it finishes. Again, choose the Remove selected part action icon and this section will be cut out. Do the same for the final section that you want to cut out.

IMPORTANT NOTE

When you pause at a given point to make a Start or End Mark, the actual point of the cut will be the nearest I-Frame. I-Frames are special frames in the video file which come about every one to four seconds. The editor can cut ONLY at an I-Frame. It is thus recommended that when you pause at the point you want to make your Start or End mark, that you click the LEFT button once (will jump to the previous I-frame) and then click the RIGHT button (shows the next I-frame) so that you can see your choice of I-Frames to cut at. Go to the I-Frame you desire and then set your Mark. Trying to set a mark between I-Frames is ineffective since the AV 700 TV will just choose the closest I-Frame.



1. Play the file and pause at the spot you want to make your Start mark. Select the Set a mark-in here action icon. Let the video play – you will notice a small blue mark.

2. Now click on Pause at the location you want to mark the end of your segment. Select the Set a mark-out action icon. Now that you have defined a segment in the video, you can click the Remove selected part or Keep selected part action icon. Although the set-mark action icons are available, you can only mark one segment at a time.

3. Continue to select or delete other segments as in 2. Once satisfied with your edits, you can Save the selection which keeps the edit points and allows you to re-edit another time, or you can Save Selection as a new File which will create a new edited file named (name_Edit0000).

23.7 Copy Protection

The AV 700 TV video recording system is designed to respect the Macrovision® copyright protection system. If the source of your video is copy protected, the AV 700 TV will record in protected mode. You will see a "P" icon on the recording screen (not during playback) indicating that the file will be a protected file. Protected files can only be played back on the AV 700 TV that created it. The file will not play on a computer. Further, the playback of protected files will be limited to the built-in LCD screen and not to an external television.

23.8 Docking Pod-Specific Options

23.8.1 Manually Setting the Scheduler



If you would like to make a video recording for a future date or time, you can use the scheduler. You can find it in the main menu. You can program up to twenty different recordings up to one month in advance. Once you program your dates and times of recording, press the action button OK to set them. You must now put your AV 700 TV into standby mode by pressing on the red Standby/wake-up button on your ARCHOS™ remote control or just leave it alone. If left alone, the AV 700 TV will go on standby itself after a few minutes.

1. Click the Scheduler icon.
2. Select the line you want to edit using the UP and DOWN buttons, then click RIGHT to start editing.
3. Set each line to the desired date, time (and channel if you are using the Infrared emitter to control your VCR, cable box, or satellite receiver). If setting a specific channel on your external appliance, make sure that the letter before the channel number is A (A stands for Analog recording and D stands for Digital TV - see section 4.2 about using the scheduler for Digital TV recordings).
4. Click on the bottom action icon Edit program title and give a name of your choosing. Click on the save icon to save the program. Click on the STOP/ESC button to return to the previous screen.
5. DO NOT shut off the AV 700 TV! Set the AV 700 TV to Standby (red 'standby' button on remote control) or go back to the main menu screen and allow it to automatically (after a couple minutes of inactivity) go into standby mode.

93

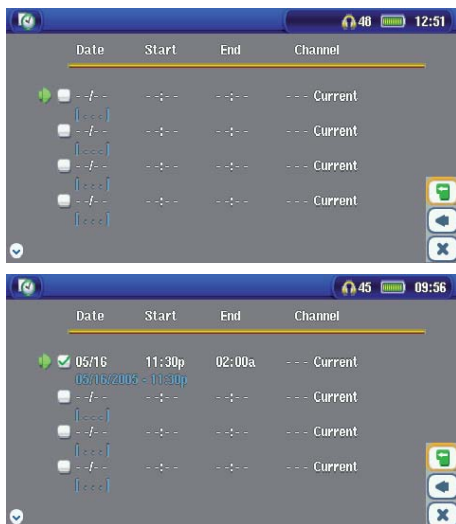

Empty Scheduler, ready to be programmed. Once a valid record time is entered, and the save button pressed, the empty box will get a green checkmark.

Scheduler after having been set. The "--- Current" means that the AV 700 TV will record the current video signal (no channel changing). This is for people who do not use the stick-on infrared emitter.

Notes about setting the Scheduler:

- The scheduler automatically reorganizes the recording events chronologically.
- In order for a scheduled recording to start, you must leave the AV 700 TV in the main menu screen or set it to standby mode (press Standby button on remote control). That is, if you are listening to music, watching a video, or looking at photos on your AV 700 TV, it will not interrupt you in order to go make the scheduled recording.
- If you have connected and will be using the IR Emitter system (see the TV Docking Pod chapter as well as the chapter Setting the Infrared Emitter code below) with a video cassette recorder (VCR) please note that in order for the IR Emitter to properly control the VCR, your VCR should not be left in sleep mode.
- When the AV 700 TV user interface is in English, the Date format is set to Month/Day.

- If the end time is earlier than the start time, then it is assumed that you start recording on the start date, and the recording ends on the following day at the end time.
- Once a scheduled recording has been made, or the date of a recording has been passed, without the recording having been made (the AV 700 TV was not connected to the docking pod or not in Standby mode), the schedule entry will be erased from the scheduler.
- Long recording times (2 hours and more) can create files that are larger than 2 gigabytes (GB) each. The AV 700 TV will create multiple files in order to make long recordings. Thus a long scheduled recording may produce video files called VID0000, VID0001, and VID0002. This is only in the case of recordings that are over 2 GB in size. This 2 GB file size constraint is due to the Windows® FAT32 AVI file type specification.
- When you set the scheduler, the AV 700 TV will create a text file in its System folder called DVRTimer.txt. You should not erase this file.

23.8.2 Automated Yahoo!® TV Recording Scheduler

For those who have a My Yahoo!® account and use the calendar feature, the AV 700 TV can read the TV programs scheduled into your personal calendar and transmit these to your AV 700 TV to be included in the AV 700 TV scheduler. This way, you do not have to input all your scheduled recordings manually. You can sign up for an account and learn how to use the My Yahoo!® TV and calendar functions at the Yahoo!® Website (www.yahoo.com).

Please note: Using the scheduler is particularly useful when you have the TV docking pod and you have set up the Infrared connector. Otherwise, the AV 700 TV will be unable to change channels on your tuner. It will record the currently selected channel. Furthermore, the AV 700 TV needs to be powered by a charger in order to go into standby mode rather than switch off completely.

You must do the following:

1. Connect your AV 700 TV to your computer.
2. Go to your personal Yahoo!® calendar which has your TV programs scheduled.
3. Choose the Week view – starting with the current day as the beginning of the week.

4. Click on Printable View to show a cleaner printable version.
5. From your browser menu click on File > Save As... to save the file.
6. Do not change the File Name, but do change the Save as Type to Web page, html only. Now save the file to the folder System on your AV 700 TV.
7. Once you disconnect the AV 700 TV from your computer, the AV 700 TV will automatically update its scheduler with the newly saved TV programs from your My Yahoo!® calendar. If the AV 700 TV encounters a television station name that it does not know the channel number for (was never set), it will indicate so, and direct you to go to the scheduler to manually assign a channel to the station name.

Notes:

- If the TV programs from your personal calendar do not seem to be correctly copied to the AV 700 TV scheduler, go to the ARCHOST™ web site to make sure that you have the very latest version of the AV 700 TV firmware. Update your firmware (Operating System) as explained in the chapter Updating the AV 700 TV firmware Operating System.
- If you change your Yahoo!® personal calendar by deleting some TV programs and adding new ones, only the new programs will be added to the AV 700 TV scheduler when you save the html file to the AV 700 TV. If you want to delete scheduled items, you must do this in the AV 700 TV scheduler itself.
- Missed recordings (because you did not have the AV 700 TV connected to the docking pod at the record time) will be deleted from the scheduler.
- If a personal calendar recording event does not find the station name in your list of channels, it will put the event into the scheduler and mark it with a ?, indicating that you must assign a channel number to the name. Move the cursor to the line containing the ?, and click on the action icon "Set Channel". You can now scroll through the channel numbers and assign a number to the station name for that event. You only have to do this once. The AV 700 TV will keep the station name and its channel number.

23.8.3 Setting the Infrared Emitter Code



This is a one time step to set your AV 700 TV to send the correct infrared codes to control your video cassette recorder, cable box, or satellite receiver. This is done so that the AV 700 TV, via the TV docking pod, can turn on and off your video device and also change its channels. If you do not plan on making scheduled recordings, then you do not need to install the IR emitter or set the infrared emitter code.

Before beginning this procedure of setting the emitter code, your AV 700 TV must be connected to the TV docking pod, the pod powered with the charger/adaptor, and the IR emitter connected to the pod. Hold the IR Emitter in front of the IR receptor (remote control reception panel on your tuner) so that the IR Emitter can control your device. See the chapter Connecting the TV Docking Pod to your Television System section Connection 5 : the Infrared Emitter of this manual if you do not know where the IR receptor on your VCR, cable box, or satellite receiver is located. Once you have verified that the AV 700 TV is controlling your VCR, cable box, or satellite receiver, (explained below) you can peel off the white ring protecting the adhesive, and stick the IR emitter to your device.

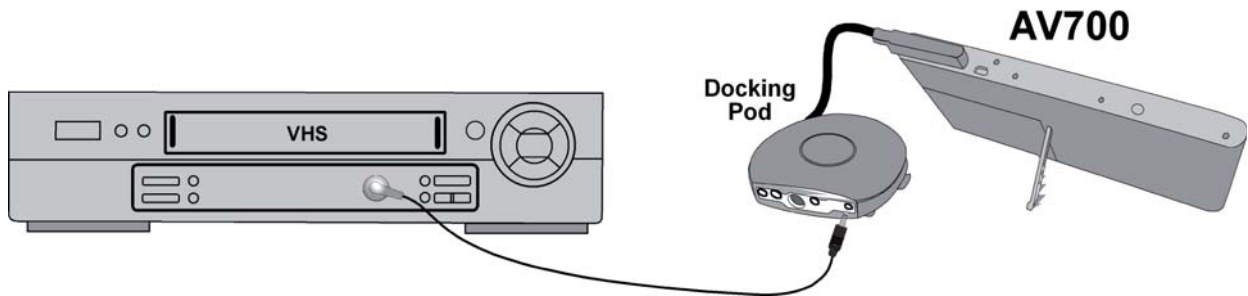

Your tuner may be your VCR, cable box, or satellite receiver.

Part 1: Choose your Device and Brand

Select the Settings action icon and click on the TV Control icon.



1. Select the type of device that you will stick your IR Emitter to. You have the choice of either a VCR (video cassette recorder), Cable Box, or Satellite Receiver.
2. Select the brand of your device.
3. Click on Tune IR Emitter button.
4. The TV Channels button allows you to give names to each channel. For example, if channel 6 is CNN where you live, then you can give channel 6 that name in this screen. Or, if you use the My Yahoo!® personal calendar to set your recording scheduler, the AV 700 TV will allow you to assign a channel number to a station name given from your scheduled TV programs. (see the chapter Automated Yahoo!® TV Recording Scheduler for details).

Part 2: Finding the Right Emitter Codes

This screen allows you to correctly set the codes and parameters to allow the Infrared emitter to correctly control your tuner (VCR, cable box, or satellite receiver).



1. Tune device code (one code available): Some manufacturers use only one code for all of their products. The code does not change from one model to another or from one year to another. In this case, there will only be one single code available. You can now test the channel select.
2. Tune device code (multiple codes available): Some makers of video equipment don't use the same set of control codes for all of their products. They have various code sets for various models and various years. You will have to try each of the codes to find

out which code works with your device. In the example screen, you see the code V009. If this code does not work when doing the Test: channel select, advance it to the next code and then test to see if that next code works.

3. Test channel select: When you press the Test channel select button (highlight test channel select and press ENTER), the AV 700 TV will send a signal through the docking pod to the infrared emitter and change the channel on your tuner (VCR, cable box, or satellite receiver). If the Number of digits parameter is set to three, it will try to select channel 123. If that parameter is set to 2, it will send the code for channel 12. If your tuner does not change channels when you click on this test button, try the next code for your device (step 2 above).
4. Test ON/OFF: When you click on the Test On/Off button, the AV 700 TV will send a signal to the infrared emitter and turn your device on or off. Click this test button again and your device should change from on to off or off to on. If pressing this button does not turn your device on or off, try the next code for your device (step 2 above). If none of the codes work, check that the infrared emitter is stuck directly over the infrared sensor on your tuner device. Note: In some rare cases the ON/OFF functionality may not work.
5. Tune channel select: These four parameters usually do not need to be set. Keep the default values to start with. See the table below for an explanation of each.

Parameter	Description
Key: -/-	Set this to On if normally, you have to press this same key on your device's remote control in order to select a channel.
Number of digits	Set the number of digits that your device can recognize for a channel. <i>Example: Set to 3 if you need to choose a channel greater than channel 99.</i>
Key: Enter	Set this to On if normally, you have to press the Enter key on your device's remote control after you enter the channel number. <i>Example: If you normally press 1, 3, Enter for channel 13, then you would need to set this parameter to On.</i>
Key Delay	Change the delay between the emission of each digit of a channel. You may need to adjust this if the AV 700 seems to send only half the digits of a channel or more digits of a channel. <i>Example: Adjust the key delay and retest channel select if it sends channel 2 instead of 12 or sends 112 instead of 12.</i>

99

100

24 Troubleshooting

24.1 USB Connection issues

Problem: I cannot get my AV 700 TV to be recognized by the computer or it asks for a driver.

Solutions:

- If you are running an operating system other than Windows® XP (Service Pack 1 minimum) with Windows Media® Player 10 or higher, the USB Port setting should be set to 'Hard Drive'. Go to **Setup > System > USB Port** and set it to '**Hard Drive**'. Only Windows® XP (Service Pack 1 or higher) with Windows Media® Player 10 or higher will allow for the USB Port '**Windows Device**' setting.
- Shut off and reboot the computer and the AV 700 TV and then try connecting again in the preferred order mentioned in the chapter **Connecting/Disconnecting the AV 700 TV to/from your PC**.
- If using a USB hub, try connecting without using the hub (some hubs are not powered and may not work with the AV 700 TV).
- If using a USB port in the front of your computer, try a USB port in the back. Front USB ports are often from non-powered hubs.
- Do not connect to a USB port repeated through a keyboard.
- If using a laptop computer and a docking station, try connecting without the docking station.
- Macintosh® users must update to OS 10.2.4 or higher.
- (Hard Drive mode) If the Files Allocation Table (FAT) gets corrupted, the AV 700 TV may not show up in Windows XP for over one minute, and then it comes up as **local drive**. Use DOS Utility **ChkDsk** as shown below.
- (Hard Drive Mode) Windows® XP may recognize the AV 700 TV hard drive but yet not assign a drive letter to it. Right click on **My Computer** and select **Manage**. Then select **Storage**, then **Disk Management**. Within this window you may see the hard drive and be able to assign a drive letter by right-clicking on the hard drive, and selecting the option **Change drive letter and paths...**

Problem: (Hard Drive mode) What do I do if I try to disconnect via the green arrow but keep getting “The device ‘Generic Volume’ cannot be stopped now. Try stopping the device again later.”

Answer: Shut off any program that might be accessing data on the AV 700 TV, including Windows® Explorer. If this does not work, shut down all programs, wait 20 seconds, then try the green arrow one or two times again. If this does not work, you can shut off your AV 700 TV with the Stop/Esc button and then unplug it.

24.2 Charging and Power issues

You do not need to fully discharge the batteries before recharging them.

Problem: A full battery charge does not last as long as the specifications suggest.

Answer: The specifications are under the condition that the screen backlight goes off after 30 seconds (for music) and the user does not access the machine, it just sits and plays. If you get significantly less time from a full charge, call our technical support hot-line.

24.3 AV 700 TV locks up (freezes operation) or Stops

Problem: The AV 700 TV locks-up. None of the buttons work.

Solution: If the ‘**Lock buttons**’ is set, none of the buttons respond. Hold down the unlock action button for three seconds to turn off the ‘**Lock buttons**’ function. A freeze up could also be caused by electrostatic phenomena. That is, static electricity has temporarily knocked out the AV 700 TV. Hold down on the STOP/OFF button for 15 seconds and the AV 700 TV will shut off. Restart it normally now.

24.4 File issues, corrupted data, formatting, and partitioning

Problem: I want to clean up my AV 700 TV’s hard drive, but Windows® will not let me use the standard hard drive cleaning tools.

Answer: This is because Windows® sees your AV 700 TV as a Windows Device and not a hard drive (USB Port is set to **Windows Device** in **Setup > System**). **Do not change back to hard drive** and run a defragmenter program. This will give unexpected results.

Problem: On the AV 700 TV, I find new file names and folder names that I never created and/or they have strange gibberish names.

Answer: (Hard drive mode) Most likely, the AV 700 TV’s file allocation table (FAT) has been corrupted. This could have been due to the AV 700 TV shutting down (due to low battery power) while reading or writing to your computer via the USB connection. To fix a corrupted FAT problem, you should use the Error Checking utility or the Check Disk utility explained at the end of this section. Attention: Windows and Macintosh often write extra files to the hard drive such as **finder.def** or **System volume info**. These are normal and will not harm the AV 700 TV.

Problem: Can I defragment the AV 700 TV’s hard drive?

Answer: (Windows Device Mode) The AV 700 TV maintains an optimized file system and does not need to be defragmented. Defragmenting will cause unexpected problems.

Problem: I want to reformat the AV 700 TV’s hard drive.

Answer: You can do this, but it will erase ALL of the data on your AV 700 TV. Sometimes this may be necessary if your FAT (File Allocation Table) becomes so corrupted that nothing seems to fix your file problems. First, as explained below, you should run ScanDisk or the DOS chkdsk (Check Disk) program to try to fix your problem. If this doesn’t fix your problem and you are sure you must reformat the AV 700 TV hard drive, then go to the screen **Settings > System** and press and hold the DOWN action button for three seconds. A button “Format HD” will appear. Use this button to format the AV 700 TV’s hard drive. Remember, doing this will erase all the data on the AV 700 TV’s hard drive!!!

Problem: My files have disappeared from the AV 700 TV.

Answer: To see all your files, in the **Browser** mode, make sure the action icon **Show all files** is turned on. Also make sure that you browse your files via the Browser mode and not a filtered view such as **Photo, Music, or Video**.

Windows® ME Running Scan-Disk (Error Checking) – HARD DRIVE mode only

- Quit all running applications.
- Properly connect the AV 700 TV to your computer as explained in the chapter **Connecting/disconnecting the AV 700 TV to/from your PC**.
- Make sure external AC adapter is powering the AV 700 TV.
- Right click on the AV 700 TV hard drive in Windows® Explorer and select Properties.
- Select the Tools option and run the Error checking program.
- Make sure you check the box to **automatically fix errors**.
- Be patient, this may take a while.

Windows® XP & 2000 Running Check Disk Utility (Chkdsk) – HARD DRIVE mode only

If you still have problems with the file system on your AV 700 TV you can try to fix it using the DOS utility, check disk (chkdsk). Do the following:

- Make sure external AC adapter is powering the AV 700 TV.
- Quit all running applications.
- Properly connect the AV 700 TV to your computer as explained in chapter **Connecting/disconnecting the AV 700 TV to/from your PC**.
- Wait patiently (up to 5 minutes) for Windows XP to show the local drive as mounted.
- Open a DOS window. Programs > Accessories > Command Prompt.
- At the prompt, type **chkdsk e: /f**. Use e: or f: or whatever drive letter is representing your AV 700 TV. The /f argument tells the program to automatically fix errors.
- Be patient, this may take a while.
- When finished, exit the DOS Window and properly disconnect the AV 700 TV from your computer.

25 Technical Specifications

ARCHOS™ AV 700 TV

DVB® ID number: 4033.



Storage Capacity	See packaging
Display	7" LCD 480x234 pixels, 262 000 colors and TV output ¹
Tuner	474 - 858 MHz (does not support VHF)
Video recording	MPEG-2 MP@ML transport stream. (With optional TV Docking Pod or AV Travel Kit: MPEG-4 SP and stereo sound in AVI format).
Video playback	MPEG-4 SP with B-Frames ² with stereo sound. Near DVD quality up to 720x480 @ 30 f/s (NTSC), 720x576 @ 25 f/s (PAL), AVI file format. WMV9 SP (including protected WMV9 SP files) up to 480x360 @ 30 f/s, ASF/WMV file format. MPEG-2 MP@ML transport stream up to 720x576 @ 25f/s with MPEG-1/2 layer 2 audio (does not play MPEG-2 files of type .vob, .mpg, or .mpeg).
Audio recording	With optional TV Docking Pod or AV Travel Kit: from an analog source in stereo sound to WAV (PCM & IMA ADPCM) format.
Audio Playback	Stereo MP3 decoding @ 30-320 kb/s CBR & VBR, WMA (including protected WMA files), WAV (PCM & IMA ADPCM), PlaysForSure download and subscription.
Photo viewer	JPEG (not progressive jpegs) and BMP formats
Television output	Video output in PAL (EU) or NTSC (US) standard
Computer Interface	High Speed USB 2.0 (compatible USB 1.1), PC and Mac USB Host port compatible Mass Storage Device & PTP (Picture Transport Protocol)
Playback Autonomy*	Up to 30 hours for music. Up to 4 hours for video files. Up to 3 ½ hours for Digital TV.
Scalability	Free Operating System updates downloadable from ARCHOS™ website



Power source	Rechargeable Lithium-Ion battery External: AC charger/adaptor. Use ONLY the specified Archos adaptor/charger supplied with this product.
Physical Dimensions	Approx.: 10,7 x 20,9 x 1,9 cm – 4.2" x 8.2" x 0.8" Weight: 590g – 20.8 oz
Temperature Range	5 °C to 35 °C running ; -20 °C to 45 °C storage
Minimum Requirements	PC: Windows ME, 2000, XP, Media Center or higher, USB port Macintosh®: G3 OS X (10.3.9) or higher, USB 2.0 port For PlaysForSure: PC with Windows® XP SP 1 or higher, Windows® Media Player 10 or higher, USB 2.0 port

**Depending on usage (stop, start, writing, file type, screen brightness, etc.)*

(1) External video output disabled for Macrovision®-protected contents.

(2) has not been certified by DivX, Inc., may not read all DivX® 4.0& 5.0 files; does not read Divx® 3.11 & 6.0 files. MPEG-4: ISO standard by Moving Picture Experts Group ; AVI: audio/video file container by Microsoft . MPEG-4 SP with B-frames AVI up to 704x480@30f/s NTSC or 720x576@25f/s PAL.

All brands and product names are registered trademarks and the property of their respective owners. Specifications are subject to change without notice. Errors or omissions excepted. Images and illustrations may not always match contents. COPYRIGHT ARCHOS © 2006. All rights reserved.

105

26 Legal and Safety Notices

WARRANTY AND LIMITED LIABILITY

This product is sold with a limited warranty and specific remedies are available to the original purchaser in the event the product fails to conform to the limited warranty. Manufacturer's liability may be further limited in accordance with its sales contract.

In general, the manufacturer shall not be responsible for product damages caused by natural disasters, fire, static discharge, misuse, abuse, neglect, improper handling or installation, unauthorized repair, alteration or accident. In no event shall the manufacturer be liable for loss of data stored on disk media.

MANUFACTURER SHALL NOT BE LIABLE FOR ANY SPECIAL, INCIDENTAL OR CONSEQUENTIAL DAMAGES. EVEN IF INFORMED OF THE POSSIBILITY THEREOF IN ADVANCE.

ARCHOS™ licensor(s) makes no warranties, express or implied, including, without limitation, the implied warranties of merchantability and fitness for a particular purpose, regarding the licensed materials. ARCHOS™'s licensor(s) does not warrant, guarantee or make any representations regarding the use or the results of the use of the licensed materials in terms of its correctness, accuracy, reliability, correctness or otherwise. The entire risk as to the results and performance of the licensed materials is assumed by you. The exclusion of implied warranties is not permitted by some jurisdictions. The above exclusion may not apply to you.

In no event will ARCHOS™'s licensor(s), and their directors, officers, employees or agents (collectively ARCHOS™' licensor) be liable to you for any consequential, incidental or indirect damages (including damages for loss of business profits, business interruption, loss of business information, and the like) arising out of the use of inability to use the licensed materials even if ARCHOS™' licensor has been advised of the possibility of such damages. Because some jurisdiction do not allow the exclusion or limitation of liability for consequential or incidental damages, the above limitations may not apply to you.

Please see your sales contract for a complete statement of warranty rights, remedies and limitation of liability.

Furthermore, warranty does not apply to:

1. Damages or problems resulting from misuse, abuse, accident, alteration or incorrect electrical current or voltage.
2. Any product tampered-with or damaged warranty seal or serial number label.
3. Any product without a warranty or serial number label.
4. Batteries and any consumable items delivered with or in the equipment.

The end user is required to use this product only in conformity with its original purpose and is strictly forbidden to make any technical modifications that could potentially impinge on the rights of third parties. Any modification to the hardware, software, or physical enclosure of the product must be approved in writing by ARCHOS™. Non approved modified products are subject to the withdrawal of any or all guarantee clauses

WARNINGS AND SAFETY INSTRUCTIONS

CAUTION

To prevent risks of electric shock, this unit must only be opened by qualified service personnel. Power off and disconnect the power supply cable before opening the unit.

WARNING

To prevent fire or shock hazard, do not expose the unit to rain or moisture.

Use of this product is for personal use only. Copying CDs or loading music, video, or picture files for sale or other business purposes is or may be a violation of copyright law. Copyrighted materials, works of art, and/or presentations may require authorization to be fully or partially recorded. Please be aware of all such applicable laws concerning the recording and use of such for your country and jurisdiction.

SAFETY

For driving safety, only a passenger should operate the device when the car is in motion and not the driver. Laws governing the usage of electronic devices by the driver may be applicable in your jurisdiction and/or country.

FCC COMPLIANCE STATEMENT

This equipment has been tested and found to comply with limits for a Class B digital device, pursuant to Part 15 of the FCC Rules. These limits are designed to provide reasonable protection against harmful interference in a residential installation. This equipment generates, uses and can radiate radio frequency energy and, if not installed and used in accordance with instructions, may cause harmful interference to radio communications. However, there is no guarantee that interference will not occur in a particular installation. If this equipment does cause harmful interference to radio or television reception, which can be determined by turning the equipment off and on, the user is encouraged to try to correct the interference by one or more of the following measures:

- Reorient or relocate the receiving antenna.
- Increase the separation between the equipment and receiver.
- Connect the equipment into an outlet on a circuit different from that to which the receiver is connected.
- Consult the dealer or an experienced radio/TV technician for help.

CAUTION: Modifications not authorized by the manufacturer may void users authority to operate this device.

FCC Part 15 - Operation is subject to the following two conditions:

- 1 This device may not cause harmful interference;
- 2 This device must accept any interference received including interference that may cause undesired operation.

ELECTROSTATIC DISCHARGE (ESD)

Normal functioning of the product may be disturbed by ESD. If so, simply reset the product to resume normal operation by following the instruction manual. During file transmission, please handle with care and operate in a static-free environment.

AVOIDING HEARING DAMAGE

This product respects the current regulations for limiting the output volume of consumer audio devices to a safe level. By listening to your device with headphones or earbuds at high volumes, you run the risk of permanent damage to your ears. Even if you get used to listening at high volumes and it seems normal to you, you still risk the possibility of damaging your hearing. Reduce the volume of your device to a reasonable level to avoid permanent hearing damage. If you hear ringing in your ears, reduce the volume or shut off your device. This device has been tested with the ARCHOS™ supplied earphones. In order to preserve your hearing, it is advised that you use only the following headphone models: the earphones supplied with your ARCHOS™ device, or any other headphones that respect the current regulations. Other types of headphones may produce higher volume levels.

107

ENVIRONMENTAL CONSIDERATIONS

Protection of the environment is an important concern to ARCHOS™. In order to put this concern into tangible actions, ARCHOS™ has consciously included a set of methods that favor a respect for the environment into the entire cycle of its products; from fabrication to consumer usage, to final disposal.

Batteries : If your product contains a detachable battery pack, you should only dispose of it in a designated collection point for used batteries.

The Product : The crossed-out garbage can symbol on your product signifies that it falls into the category of electric/electronic equipment. Products of this type contain substances that are potentially dangerous to the environment and to human health. Therefore, you should not dispose of the ARCHOS™ electronic device in a regular trash. As such, the current European directives ask that this device be collected:

- At places of distribution in the case of a purchase of a similar electronic product.
- At locally created disposal areas (waste disposal centers, sorted trash system, etc.)

By doing this, you are actively participating in the reuse and recycling of disposed electronic and electric equipment that could have potential effects on the environment and human health.

**AUTOMOBILE INSTALLATION**

Archos shall be released ipso jure from any liability in the event of failure to use and/or operate the product in compliance with any regulation in force and/or with the specifications and directions for use, or for any damage incurred by incorrect use of the product. The user must ensure the correct installation of the product and its correct utilisation according to the nature of such product.

LCD PIXEL POLICY

The LCD screen on your ARCHOS™ AV 700 TV unit has been manufactured to rigorous standards to provide a high quality viewing experience. Nevertheless, your LCD screen may have slight imperfections. This is not particular to the ARCHOS™ screen, but to all devices which have LCD screens regardless of the original manufacturer of the LCD. Each product vendor guarantees that his screen will contain no more than a certain number of defective pixels. Each screen pixel contains three dot elements (Red, Blue, and Green). One or all of the dots in a given pixel may be stuck on or stuck off. A single dot stuck off is the least noticeable. All three dots of a pixel stuck on is the most noticeable. ARCHOS™ guarantees that its AV 700 TV screen will have no more than 2 defective pixel (regardless if these pixels have one or more defective dots). This means that during the period of guarantee for your country or jurisdiction, if the screen on your product has three or more defective pixels, ARCHOS™ will repair or replace your AV 700 TV product at its cost. Thus, two or less defective pixels is not grounds for replacement or repair of the product.

COPYRIGHT NOTICE

Copyright ARCHOS™ © 2006. All rights reserved.

This document may not, in whole or part, be copied, photocopied, reproduced, translated or reduced to any electronic medium or machine-readable form without prior consent, in writing, from ARCHOS™. All brands and products names are registered trademarks and the property of their respective owners. Specifications are subject to change without notification. Errors and omissions accepted. Images and illustrations may not always match contents.

Disclaimer of warranty: to the extent allowed by applicable law, representations and warranties of non-infringement of copyrights or other intellectual property rights resulting from the use of the product under conditions other than as here above specified, are hereby excluded.

Worldwide Offices	
United States & Canada	Europe & Asia
ARCHOS™ Technology 3, Goodyear - Unit A Irvine, CA 92618 USA Phone: 1 949-609-1483 Fax: 1 949-609-1414	ARCHOS™ S.A. 12, rue Ampère 91430 Igny France Phone: +33 (0) 169 33 169 0 Fax: +33 (0) 169 33 169 9
United Kingdom	Germany
ARCHOS™ (UK) Limited PO Box 1420 Southampton SO15 1WF United Kingdom Phone: +44 (0) 1264 366022 Fax: +44 (0) 1264 366626	ARCHOS™ Deutschland GmbH Business Park Vierwinden Konrad-Zuse-Str. 22 41516 Grevenbroich Germany Tel: + 49 (0) 21 82 – 570 41-0 Fax: + 49 (0) 2182/57041-70