



**Azbox Elite
Azbox Premium**

User Manual

High Definition
Digital Satellite Receiver
Personal Video Recorder



Danger

DANGER indicates an immediate hazardous situation which, if not avoided, will result in death or serious injury.

- Do not attempt to modify this receiver in any way. To do so may result in fire, injury, electronic shock or severe damage to you or your receiver. Internal inspection, maintenance and repairs should only be carried out by your dealer or OpenSat.
- Please do not use this receiver in close proximity to flammable or explosive gases, as this could increase the risk of explosion.
- Should any form of liquid or a foreign object enter the receiver, do not use the receiver. Power off the receiver, and then disconnect the power cord. You must contact your dealer or OpenSat. Do not continue to use the receiver as this may cause a fire or electric shock.
- Do not insert or drop metallic or inflammable foreign objects into the receiver through ventilation holes or access points e.g. smart card slot or CAM slot. This may cause a fire or electronic shock.
- Do not operate this receiver with wet hands. This could pose a risk of electronic shock.

Warning

Use only with the cart, stand, tripod, bracket, or table specified by the manufacturer or sold with the apparatus. When a cart is used, use caution when moving the cart/apparatus combination to avoid injury from tip-over.

- (a) Changes or modifications not expressly approved by the party responsible for compliance could void the user's authority to operate the equipment.
- (b) The mains plug, which is used as a disconnect device, shall remain readily operable.

When you use USB devices such as USB hard-disk drive (HDD) and USB memory stick, or internal hard-disk drive (HDD) with this receiver, you should make sure that the HDD be formatted in **FAT file system, not NTFS**. In case you use NTFS formatted HDD,

- (a) PVR feature is not supported.
- (b) The receiver may not boot-up properly.
- (c) Even with FAT formatted USB HDD, please connect it to your receiver only after the receiver completed booting.
- (d) If you power on/off the receiver with the NTFS formatted USB device connected to the receiver, STB may get damaged or may not start properly.

Caution



- (a) Always follow these instructions to avoid the risk of injury to yourself or damage to your equipment.
- (b) Unplug the receiver from the AC power outlet before cleaning. Use only a damp cloth for cleaning the exterior of the receiver.
- (c) Do not use accessories or attachments not recommended by the receiver manufacturer, as they may cause hazards and will void the warranty.
- (d) Do not operate the receiver in high-humidity areas, or expose it to water or moisture.
- (e) Do not place the receiver on an unstable cart, stand, tripod, bracket, or table. The receiver may fall, causing serious personal injury and damage to the receiver.
- (f) Do not block or cover slots and openings in the receiver. These are provided for ventilation and protection from overheating. Never place the receiver near or over a radiator or heat register. Do not place the receiver in an enclosure such as a cabinet without proper ventilation.
- (g) Do not stack the receiver on top of or below other electronic devices.

- 
- (h) Operate the receiver using only the type of power source indicated on the marking label. Unplug the receiver power cord by gripping the power plug, not the cord.
- (i) Route power supply cords so that they are not likely to be walked on or pinched by items placed upon or against them. Pay particular attention to cords at plugs, convenience receptacles, and the point where they exit from the unit.
- (j) Use an outlet that contains surge suppression or ground fault protection. For added protection during a lightning storm, or when the receiver is left unattended and unused for long periods of time, unplug it from the wall outlet and disconnect the lines between the receiver and the antenna. This will provide some protection against damage caused by lightning or power line surges.
- (k) Do not attempt to service the receiver yourself, as opening or removing covers may expose you to dangerous voltage, and will void the warranty. Refer all servicing to Authorized service personnel.
- (l) Unplug the receiver from the wall outlet and refer servicing to authorized service personnel whenever the following occurs:
- The power supply cord or plug is damaged;
 - Liquid has been spilled, or objects have fallen into the receiver;
 - The receiver has been exposed to rain or water;
 - The receiver has been dropped or the chassis has been damaged;
 - The receiver exhibits a distinct change in performance.

Safety Precautions

Please read carefully the following safety precautions.

The mains power must be 90 to 250 volts. Check it before connecting the digital receiver to the mains socket. For the power consumption of the digital receiver, see 6.1.

The mains socket should be near the equipment. Do not run an extension lead to the unit.

Do not expose the digital receiver to any moisture. The digital receiver is designed for use indoors only. Use dry cloth when cleaning the digital receiver.

Place the digital receiver on a firm and level surface.

Do not place the digital receiver close to heat emitting units or in direct sunlight, as this will impair cooling. Do not lay any objects such as magazines on the digital receiver. When placed in a cabinet, make sure there is a minimum space of 10 centimeters around it. For the physical specification of the digital receiver, see 6.1.

Protect the power cord from being walked on or pinched. If the cord is damaged, do not use the digital receiver and get the cord replaced.

Never open the digital receiver casing under any circumstances, or the warranty will be void.

Refer all servicing to a qualified service technician.

Table of Contents

1. Introduction	11
1.1 Features	11
1.2 Package Contents	13
1.2.1 Azbox Elite.....	13
1.2.2 Azbox Premium.....	14
1.3 The front panel	15
1.3.1 Azbox Elite.....	15
1.3.2 Azbox Premium.....	16
1.4 The Rear panel	18
1.4.1 Azbox Elite.....	18
1.4.2 Azbox Premium.....	20
1.5 The remote control	22
1.5.1 Azbox Elite.....	22
1.5.2 Azbox Premium.....	25
1.5.3 Premium Model RCU.....	28
1.5.3.1 STB Code output Format (Varied NEC protocol).....	28
1.5.3.2 TV Universal configuration 1 (4-digit number input).....	28
1.5.3.3 TV Universal configuration 2 (Auto search).....	28
1.5.3.4 TV configuration number search (ID Recall).....	29
1.5.3.5 TV List.....	29
1.6 CI (Common Interface)	30
1.6.1 To watch a pay service.....	30
2. Installations	32
2.1 Connections to antenna	32
2.2 Connections to TV	33
2.2.1 HDMI connector.....	34
2.2.2 SCART connector.....	35
2.2.3 Component video connector.....	36
2.2.4 Composite video connector.....	37
2.2.5 Audio connection.....	38
2.3 Installing batteries	39
2.4 Powering on for the first time	40
2.4.1 Powering on and checking picture.....	41
2.5 Firmware Update	42
2.5.1 Checking the firmware information.....	42
2.5.1.1 Internet.....	43
2.5.1.2 USB Storage.....	44
3. Settings	46

3.1	System Information	46
3.2	Language/Time settings	47
3.2.1	Menu Language	48
3.2.2	Audio Language / Sub audio language	48
3.2.3	Subtitle language.....	49
3.3	Local time setting	50
3.4	Timer	53
3.4.1	Timer Number.....	53
3.4.2	Timer State.....	54
3.4.3	Timer Cycle.....	54
3.4.4	Timer Service	54
3.4.5	Time	54
3.5	Internet	55
3.5.1	Network.....	55
3.5.2	IP Setting	55
3.5.3	Speed Check.....	56
3.6	Storage	57
3.6.1	Device.....	57
3.6.2	Partition.....	57
3.6.3	Partition Format	58
3.7	Video and audio settings	59
3.7.1	Video Format.....	60
3.7.2	Video resolution	60
3.7.3	Screen Format.....	61
3.7.4	Display Format	61
3.7.5	Video Output	61
3.7.6	Default Audio Format.....	62
3.7.7	Audio Output.....	62
3.7.8	Dolby Output.....	62
3.7.9	RF Channel Number	63
3.7.10	RF Audio Type.....	63
3.8	TV Channel	64
3.8.1	Antenna Setup	64
3.8.1.1	Satellite Name	65
3.8.1.2	LNB Frequency.....	66
3.8.1.3	DiSEqC.....	67
3.8.1.4	22KHZ Tone.....	67
3.8.1.5	0/12V Switch	67
3.8.1.6	LNB Power	67
3.8.1.7	TP Frequency	68
3.8.1.8	Positioner Setup.....	68
3.8.1.9	Network Search.....	71
3.8.2	Satellite Scan.....	72
3.8.3	TP Scan	73
3.8.4	Advanced Scan.....	74
3.8.4.1	PID Edit	74

3.8.5	SAT/TP Edit.....	75
3.8.5.1	Add satellite (TP).....	75
3.8.5.2	Delete Satellite (TP).....	75
3.9	Parental control	76
3.9.1	Change password.....	76
3.9.2	Menu lock feature.....	77
3.9.3	Age rating control / Age limit.....	77
3.10	Data Reset	79
3.10.1	Factory setting.....	79
3.10.2	Delete all channels.....	80
3.10.3	Delete satellite channels.....	80
3.11	GOGO-list	81
4.	Main Menu	82
4.1	TV	83
4.1.1	Watching television.....	83
4.1.1.1	Changing Channels.....	83
4.1.1.2	Adjusting the Volume.....	83
4.1.2	Channel Selection.....	84
4.1.2.1	How to sort the channels.....	85
4.1.2.2	Favorite channel lists.....	86
4.1.2.3	Channel Edit.....	87
4.1.2.4	Program Information.....	88
4.1.2.5	Selecting subtitle lists.....	89
4.1.2.6	Viewing Teletext.....	90
4.1.2.7	Selecting audio lists.....	90
4.1.3	EPG (Electronic Program Guide).....	91
4.1.3.1	EPG (Electronic Program Guide).....	92
4.1.3.2	Single EPG.....	93
4.1.3.3	Search EPG.....	93
4.1.4	PVR (Personal Video Recorder).....	93
4.1.4.1	PVR.....	94
4.1.4.2	Record Live TV.....	96
4.1.4.3	Reserve Record/Play.....	96
4.1.4.4	Reserve recordings using the EPG.....	98
4.1.4.5	Recording a pay service program.....	98
4.1.4.6	Recorded Program.....	99
4.1.4.7	Reserved Program.....	99
4.1.4.8	Time-Shift.....	100
4.2	YouTube	102
4.2.1	How to search in the YouTube.....	102
4.2.2	Load Video Lists.....	104
4.3	File Play & Management	105
4.3.1	Movie / Music / Photo.....	105
4.3.1.1	Movie.....	106
4.3.1.2	Music.....	107
4.3.1.3	Photo.....	108

4.3.2	File Management	109
4.3.2.1	Move files to another folder	110
4.4	<i>RSS News</i>	111
4.4.1	Add new category	112
4.4.2	Register new channel	112
4.5	<i>Browser</i>	113
4.5.1	Favorite List	113
5.	Network	115
5.1	<i>Connect the digital receiver to the computer</i>	115
5.2	<i>Connect the computer to the digital receiver</i>	115
5.2.1	Windows XP	116
5.2.2	Windows Vista	116
6.	Product specifications / Warranty	118
6.1	<i>Product specifications</i>	118
6.1.1	Power specifications	118
6.1.1.1	Azbox Elite	118
6.1.1.2	Azbox Premium	118
6.1.2	Physical specifications	118
6.1.2.1	Azbox Elite	118
6.1.2.2	Azbox Premium	119
6.2	<i>Warranty</i>	120
6.2.1	Warranty Terms and Conditions	120
6.2.2	Provisions of Warranty	120
6.2.3	Notes regarding warranty maintenance	122
6.2.4	Disclaimer of Warranty	123
7.	Appendix A. 802.11b/g Specification	124
8.	Appendix B. TV Brand List	125

1. Introduction

The Azbox Elite/Premium HD digital receiver is fully compliant with the international Digital Video Broadcasting(DVB) standard, and thus is able to receive digital broadcasts of that standard.

For its operation you need an antenna, which must be installed appropriately.

NOTE

In general we equate a channel with a frequency. However, unlike analogue broadcasts, digital broadcasts are not all assigned to their own frequencies; instead, multiple television broadcasts are transmitted through a single frequency. The frequency in digital broadcasting is usually called transponder. To reduce confusion in this manual, the word service is preferably used than channel as a term to indicate one television or radio broadcast.

1.1 Features

The Azbox Elite/Premium HD digital receiver has the following features:

- Supports DiSEqC 1.0, DiSEqC 1.2 and USALS.

- Can store up to 15,000 television and radio services.

- You can edit the services list.

- You can create favorite lists of your favorite services.

- You can view information about the current television or radio program.

Has an electronic program guide that provides an overview of scheduled programs.

You can record one service while you are currently watching another.

The large storage capacity of the hard disk drive allows you to record up to about 60 hours of television—in case of 250 gigabytes—in excellent picture and sound quality.

Time shift is a special technical feature available on the Azbox Elite (PVR Ready) /Premium (PVR). You can pause the program you are watching and resume it again at a later time. Then you can quickly go to any part of the current program by fast forward or backward search.

1.2 Package Contents

Before going any further, check that you have received the following items with your digital receiver.

1.2.1 Azbox Elite

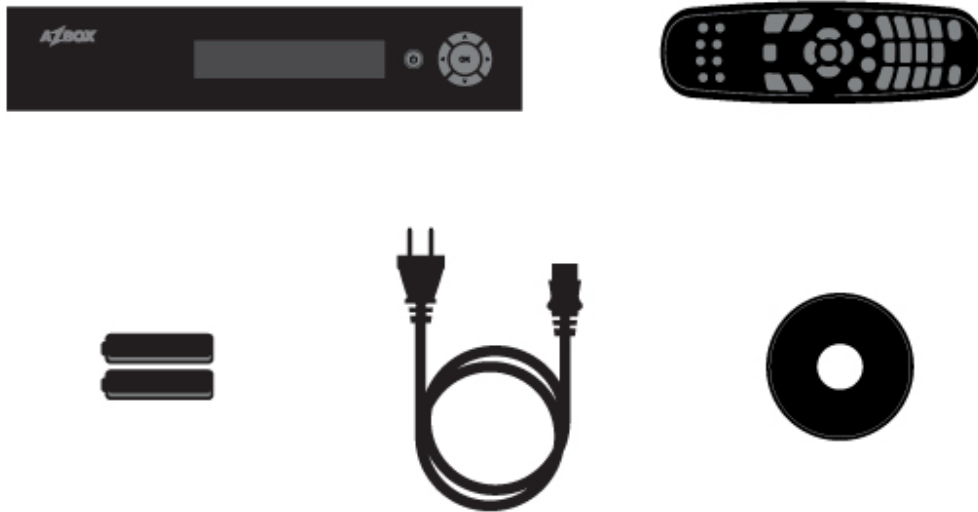

- Azbox Elite
- Remote control unit
- Two batteries for the remote control (AAA 1.5V)
- One power cable
- User Guide CD

1.2.2 Azbox Premium

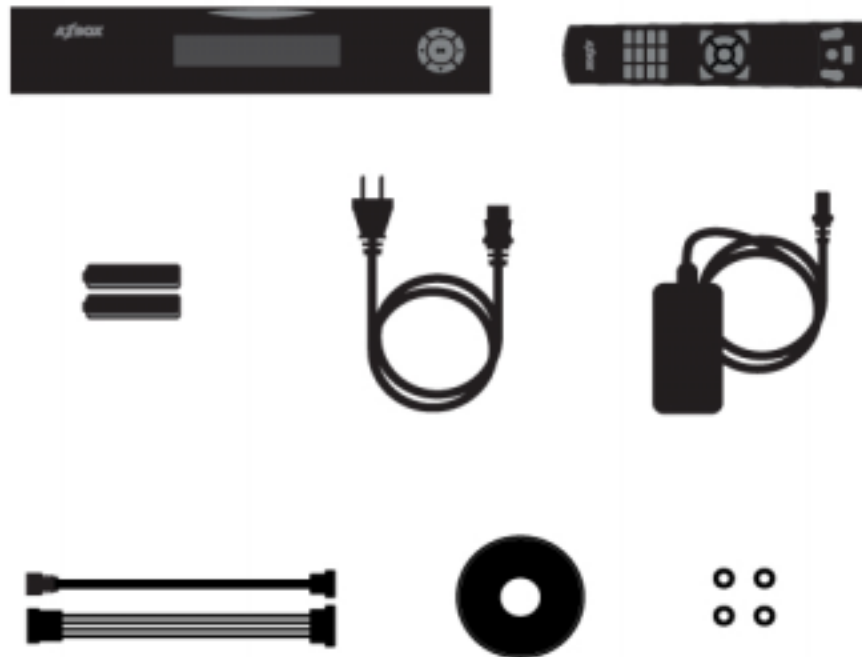

- Azbox Premium
- Remote control unit
- Two batteries for the remote control (AAA 1.5V)
- One power adaptor
- One power cable
- One SATA cable
- User Guide CD
- Four Screw bolts

NOTE

Accessories may vary according to your local area.

1.3 The front panel

The front panel of the Azbox Elite/Premium has buttons to perform basic functions such as changing channels, adjusting volume, and powering on and off. And specific LEDs and a display to indicate its status. The following indicates what they mean.

1.3.1 Azbox Elite

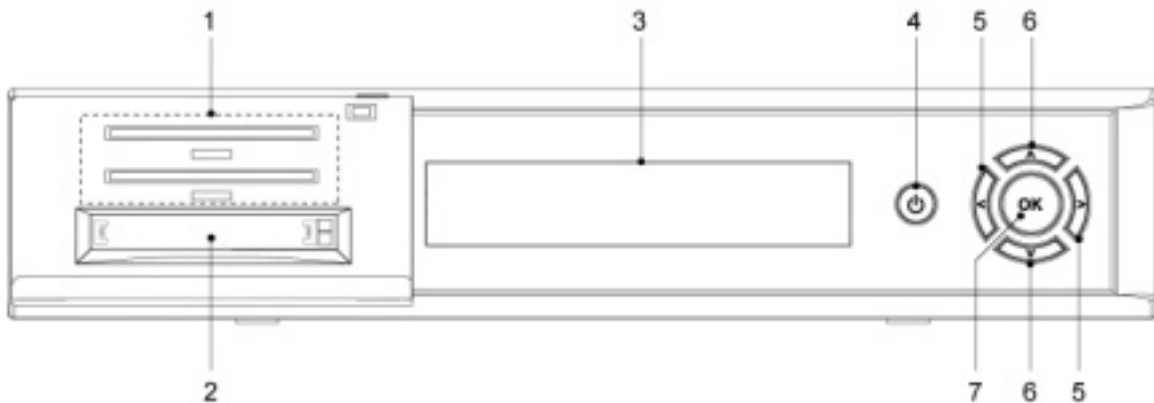

One SMART CARD Slot: Supports electronic commerce using a smart card.

Two CI CARD Slots: Connect to support devices.

Main Display: Display the current channel name. While the receiver is in stand-by mode, it will show the current time.

Power button: Switch the digital receiver between stand-by mode and operation mode. To reboot the receiver, press this button for 3 seconds.

VOLUME +/- buttons: Increase or decrease the volume.

CHANNEL \wedge/\vee buttons: Switch to previous or next service. They are also used to navigate around menu screens.

OK button: Determine your selection or to display channel selection.

1.3.2 Azbox Premium

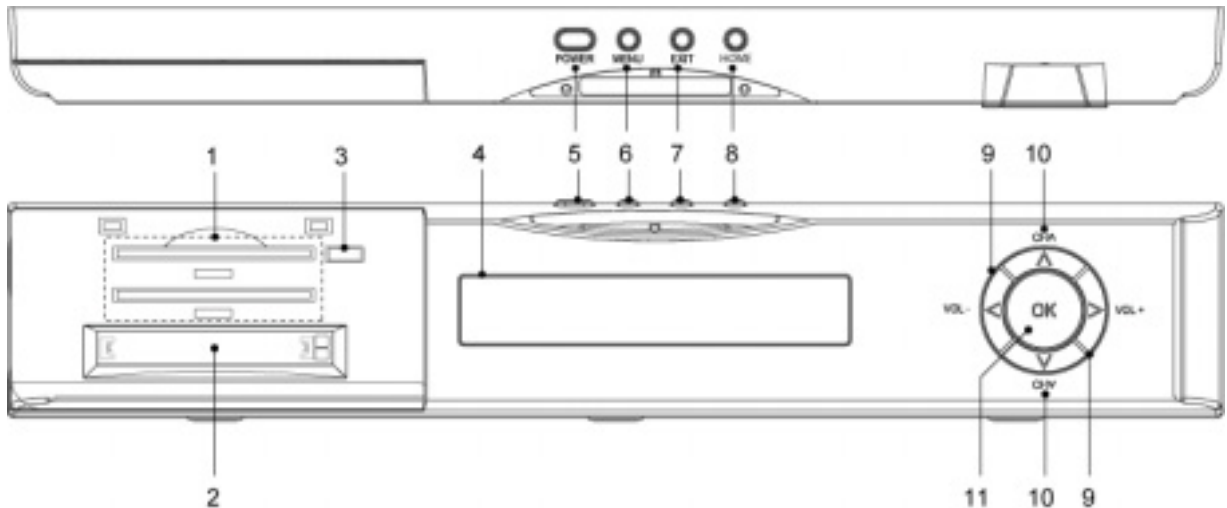

One SMART CARD Slot: Support electronic commerce using a smart card.

Two CI CARD Slots: Connect to support devices.

USB Slot: Connect to support devices. (Premium model has two USB slots. One is on the front, the other is on the rear panel)

Main Display: Display the current channel name. While the receiver is in stand-by mode, it will show the current time.

LED Indicator

Power LED: Blue LED while the digital receiver is on.

REC LED: Red LED when you are recording a program.

HD Channel LED: Green LED when receiving a HD(High Definition) program.

Power button: Switch the digital receiver between stand-by mode and operation mode. To reboot the receiver, press this button for 3 seconds.

MENU button: Enter the detail menu.

EXIT button: Exit menus, EPG(Electronic Program Guide), and program information.

Home button: Enter the main menu.

VOLUME +/- buttons: Increase or decrease the volume.

CHANNEL \wedge/\vee buttons: Switch to previous or next service.

They are also used to navigate around menu screens.

OK button: Determine your selection or to display channel selection.

1.4 The Rear panel

The Azbox Elite/Premium has a wide range of connections on the back. Check what connections your television set has in comparison with the digital receiver. The following indicates what they mean.

1.4.1 Azbox Elite

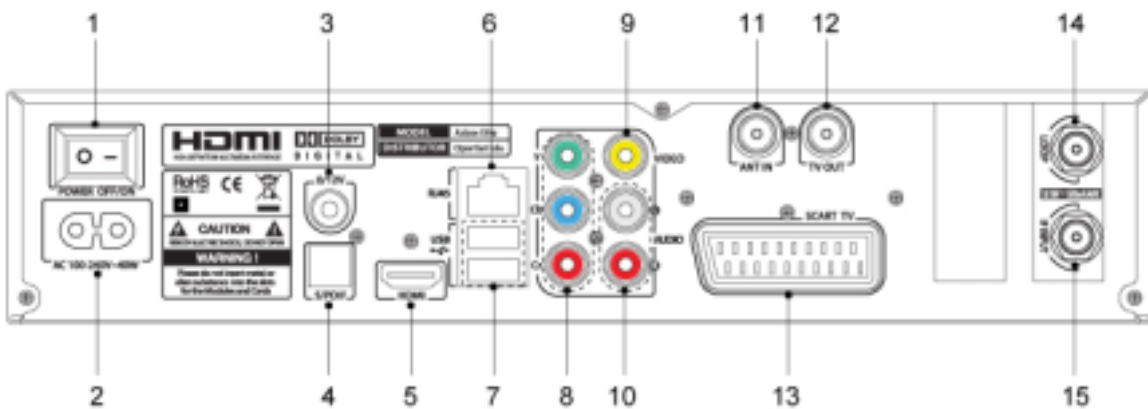

POWER SWITCH: Turn the digital receiver On and OFF.

AC POWER INPUT: Connect AC power cord to deliver power to the digital receiver.

0/12V: 0V or 12V output

S/PDIF: Dolby digital output socket for the audio system.

HDMI: Audio and video output socket for the high definition television set.

LAN: Local area network port.

Two USB Slots: Connect to support devices.

Y/Cb/Cr: Component video output socket for the television set.
(green/blue/red)

VIDEO: Composite video output socket for the television set.
(yellow)

AUDIO L/R: Stereo audio output socket for the television set or the audio system. (white/red)

ANT IN: Connect with TV RF antenna.

TV OUT: Connect with RF feed.

SCART TV: Audio and video output socket for the television set.

LNB OUT: Satellite broadcasting signal output socket.

LNB IN: Satellite broadcasting signal input socket.

1.4.2 Azbox Premium

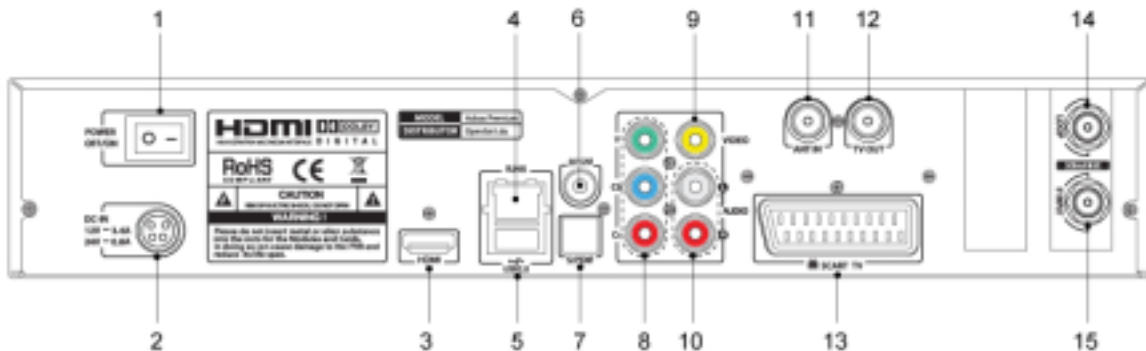

POWER SWITCH: Turn the digital receiver On and OFF.

AC POWER INPUT: Connect AC power cord to deliver power to the digital receiver.

HDMI: Audio and video output socket for the high definition television set.

LAN: Local area network port.

USB Slot: Connect to support devices.

0/12V: 0V or 12V output

S/PDIF: Dolby digital output socket for the audio system.

Y/Cb/Cr: Component video output socket for the television set. (green/blue/red)

VIDEO: Composite video output socket for the television set. (yellow)

AUDIO L/R: Stereo audio output socket for the television set or the audio system. (white/red)

ANT IN: Connect with TV RF antenna.

TV OUT: Connect with RF feed.

SCART TV: Audio and video output socket for the television set.

LNB OUT: Satellite broadcasting signal output socket.

LNB IN: Satellite broadcasting signal input socket.

Table 1.4: Connectors specifications

HDMI	High definition video output Left & right audio output Dolby digital audio output
VIDEO	Composite video (CVBS) output
AUDIO	Left & right audio output
YCbCr	Component video (YUV) output
S/PDIF	Dolby digital audio output
USB	2.0 Host (5V, 500 mA)





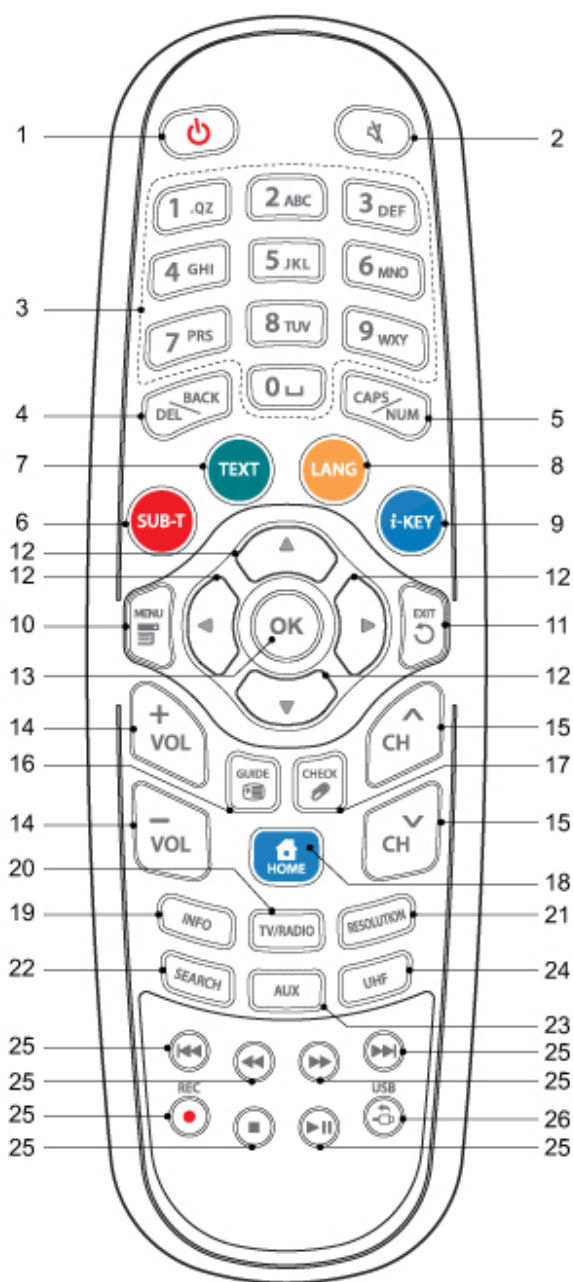

1.5 The remote control

1.5.1 Azbox Elite





- 1) **Power** (23

Press twice to display more information about a program.

- 20) **TV/RADIO** (): Switch between TV services and radio services.
- 21) **RESOLUTION** (): Change aspect ratio. See § 3.5.1 for more details.
- 22) **SEARCH** (): Search internet address (Only use in YouTube and Browser Menu)
- 23) **AUX** (): Switch to antenna/cable bypass input signal.
- 24) **UHF** (): Display and select the UHF channel for the RF modulator.
- 25) **PREV / REW / F.FWD / NEXT / STOP / PLAY&PAUSE / REC** (): Support basic operation for On-Screen Display
- 26) **USB** (): Display the list of files that are stored on the USB memory stick.

Numbers from 1 to 5 are for TV control buttons.

- 1) **TV/AUX** (\wedge/ \vee button icon" data-bbox="368 264 418 284>): Change the channels up and down.
- 4) **TV Power** (26

- 17) **CHECK** (27

passwords, on-screen keyboard and to set time.

- 33) **DEL/BACK** (



1.5.3 Premium Model RCU

1.5.3.1 STB Code output Format (Varied NEC protocol)

uPD6121 base, wordtime = 109.5msec output.

All the keys have the same Break code(0xFF, 0x00)

1.5.3.2 TV Universal configuration 1 (4-digit number input)

Press **TV/AUX**() + **OK**() buttons for 3 seconds, then, the **TV Power**() button will turn on.

With the **TV Power**() turns on, press 4-digit numbers according to TV brand list. See **7. Appendix**. If there are multiple numbers for the same brand, repeat the process 2 until TV turns off.



After TV turned off, press the **OK**() button.

The **TV Power**() button will blink three times, and configuration is done.

1.5.3.3 TV Universal configuration 2 (Auto search)

Press **TV/AUX**() + **OK**() buttons for 3 seconds, then the **TV**



Power() button will turn on.



With the **TV Power**() button turned on, press the  or  button until TV turns off.

After TV turned off, press the **OK**() button.

The **TV Power**() button will blink three times, and configuration is done.

1.5.3.4 TV configuration number search (ID Recall)

Press **TV/AUX**() + **OK**() buttons for 3 seconds, Then the **TV Power**() button will turn on.

With the **TV Power**() button turned-on, if the **Info**() button is pressed, saved numbers in RCU can be verified with blinking the **TV Power**() button.

The  button will quickly blink five times, and configuration is done.

1.5.3.5 TV List

Please refer to the TV List and TV codes in **7. Appendix B. TV Brand List**.

1.6 CI (Common Interface)

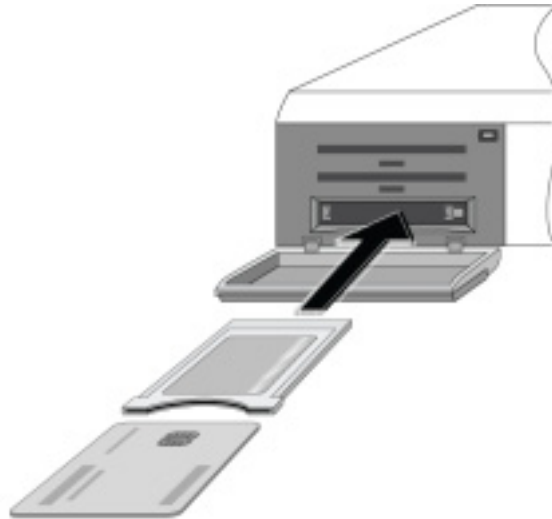



Some broadcasts are scrambled so that only paid subscribers can enjoy them. Scrambled services can only be viewed with a Conditional Access Module (CAM) and a subscription card belonging with the scrambling system. Common Interface (CI) is the slot on a digital receiver into which a conditional access module may be inserted. The front of the digital receiver has two common interfaces.

1.6.1 To watch a pay service

To watch a pay service, you should take the following steps:

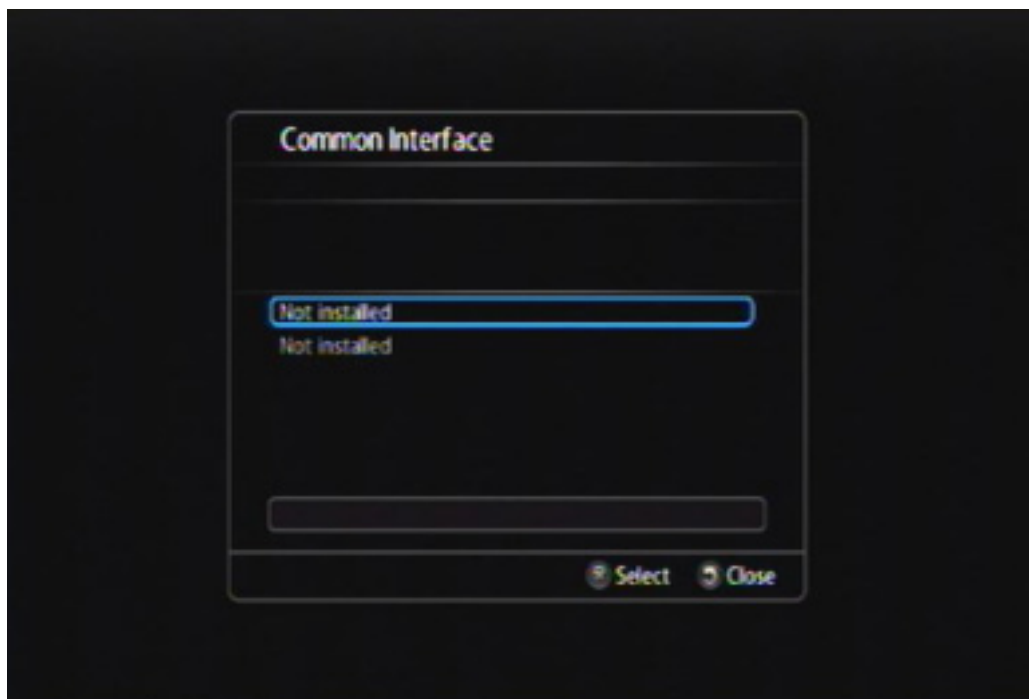
1. Purchase a conditional access module and a subscription card for the pay service you want to watch.
2. Insert the subscription card into the conditional access module.
3. Insert the conditional access module into a common interface on the front of the digital receiver.



To view the information about the module and subscription card which is inserted into the digital receiver, press the Menu() button. You should see a screen like picture above.

2. Installations

There are several ways to set up the digital receiver. Set up the digital receiver suitably to your television and other appliances. If you have any problem with your setup or need help, contact your dealer.

2.1 Connections to antenna

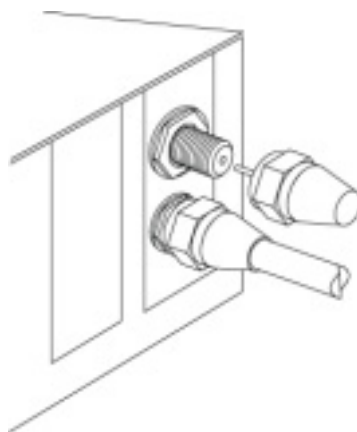

Whatever sort of connection you have between the digital receiver and the television, you need to connect the digital receiver to your television antenna so that it can receive digital television services.

Connect the antenna cable to the LNB IN connector on the back panel of the digital receiver.

2.2 Connections to TV

Between all the following connectors of the digital receiver, we recommend you to use the first connector to get best picture quality. If your television does not have the matching connector, then use the next connector in the following order for better picture quality.

1. HDMI connector (HDMI)
2. SCART connector (TV)
3. Component connector (YCbCr)
4. Composite connector (VIDEO)
5. RF Modulator

You should configure audio and video settings after connecting up the digital receiver. See § 3.6 for a detailed description.

2.2.1 HDMI connector

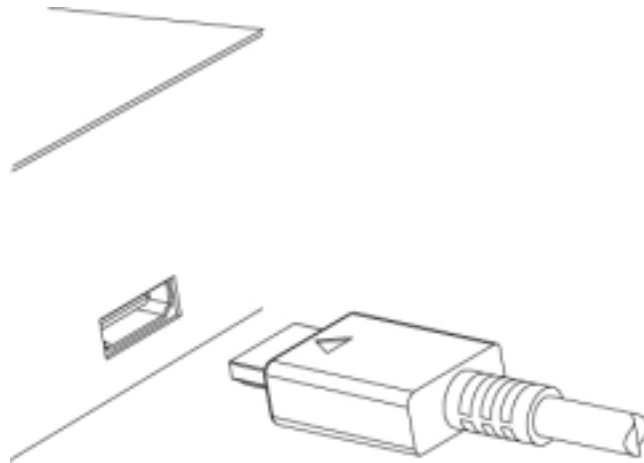

If you have a high definition television set, you should use a HDMI cable for best results. Plug one end of the cable into the HDMI socket on the digital receiver, and plug the other end into the matching socket on your television. In this case, you do not have to make audio connection because the HDMI connector can output stereo audio or Dolby digital audio.

NOTE

HDMI connector does not support 480i resolution.

2.2.2 SCART connector

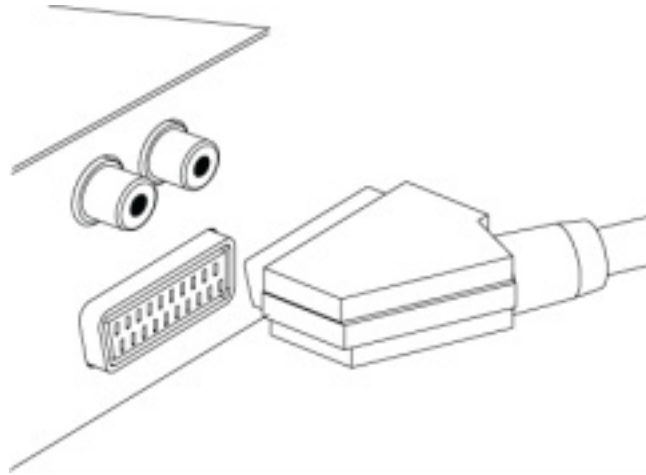

For best results with a standard television set, you should use a SCART cable. Plug one end of the cable into the TV socket on the digital receiver, and plug the other end into a free SCART socket on your television. Some televisions have inputs via S-Video or Component connectors rather than SCART. If you have such a television, use an appropriate conversion cable to link the TV socket on the digital receiver to the matching socket on your television. If you connect with a standard SCART cable, you do not have to make audio connection because the SCART connector can output stereo audio. But if you use a conversion cable, such as SCART-to-Component, you have to make audio connection.

NOTE

You cannot view high definition video with the SCART connector.

2.2.3 Component video connector

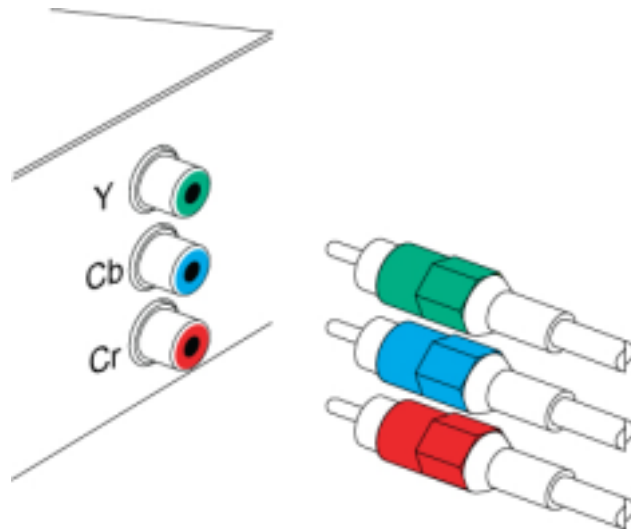

You need to obtain a component video cable(RCA cable) to use the component video connector. Plug one ends of the cable into the Y(green), Cb(blue) and Cr(red) sockets on the digital receiver, and plug the other ends into the matching sockets on your television.

2.2.4 Composite video connector

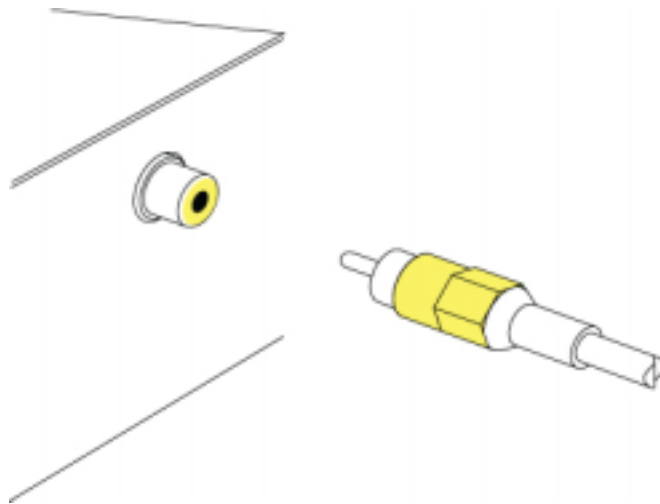

You need to obtain a composite video cable(RCA cable) to use the composite video connector. Plug one end of the cable into the VIDEO(yellow) socket on the digital receiver, and plug the other end into the matching socket on your television.

NOTE

You cannot view high definition video with the composite video connector.

2.2.5 Audio connection

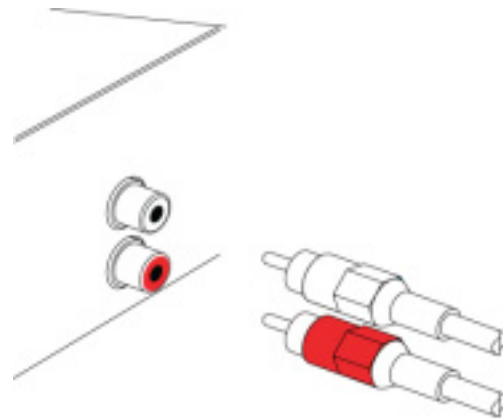

You need to obtain an audio cable(RCA cable) to connect the audio connectors. Plug one end of the cable into the AUDIO L(white) and AUDIO R(red) sockets on the digital receiver, and plug the other end into the matching sockets on your television or audio system.

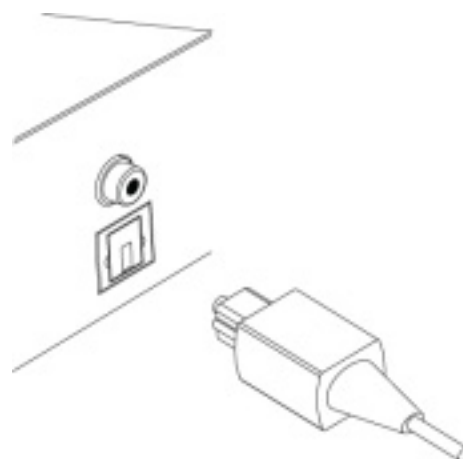

To enjoy Dolby digital audio, your television or audio system must be able to decode Dolby digital audio, and you need to obtain a S/PDIF

cable. Plug one end of the cable into the S/PDIF socket on the digital receiver, and plug the other end into the matching socket on your audio system.

2.3 Installing batteries

To Install batteries in the remote control, perform the following steps:

1. Take off the battery cover from back of the remote control.
2. Install two AAA batteries, follow the instruction described in the container and make sure the polarity(+ / -) direction is correct.
3. Put on the battery cover back.

NOTE

- Do not mix battery types. (Alkaline and Manganese)
- Do not short-circuit, heat, burn or disassemble batteries.
- Used batteries must not be disposed together with your household waste. Please, inquire about the local regulations regarding disposal of used batteries.

2.4 Powering on for the first time

[Azbox Elite]

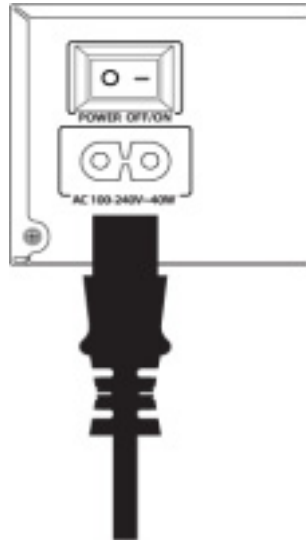

[Azbox Premium]

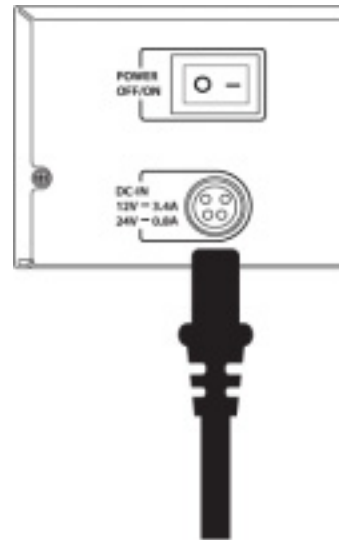

Now that you have your digital receiver connected, you should plug it into a mains socket and turn on the Power Switch at the backside.

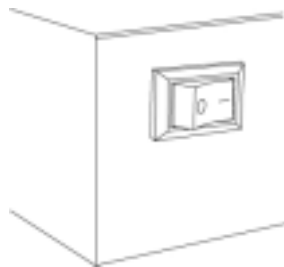

The front panel indicator will be lit blue.

NOTE

- Your receiver, as any electronic equipment, is power consuming. In order to reduce power consumption, please switch your receiver to standby whenever you are not using it.
- For saving energy compared to the stand by mode, if you are not using your receiver for a longer period of time, we recommend to switch off the receiver by unplugging it from the mains.

2.4.1 Powering on and checking picture

After a few seconds you may see a picture displaying a menu. If you do not see a picture, try pressing the Resolution () button on the remote control. If after several tries you still get no picture, check that the television is set to the correct input.

2.5 Firmware Update

The digital receiver has a stable and convenient firmware to use. However, once in a while a new firmware may be released to improve the digital receiver.

2.5.1 Checking the firmware information

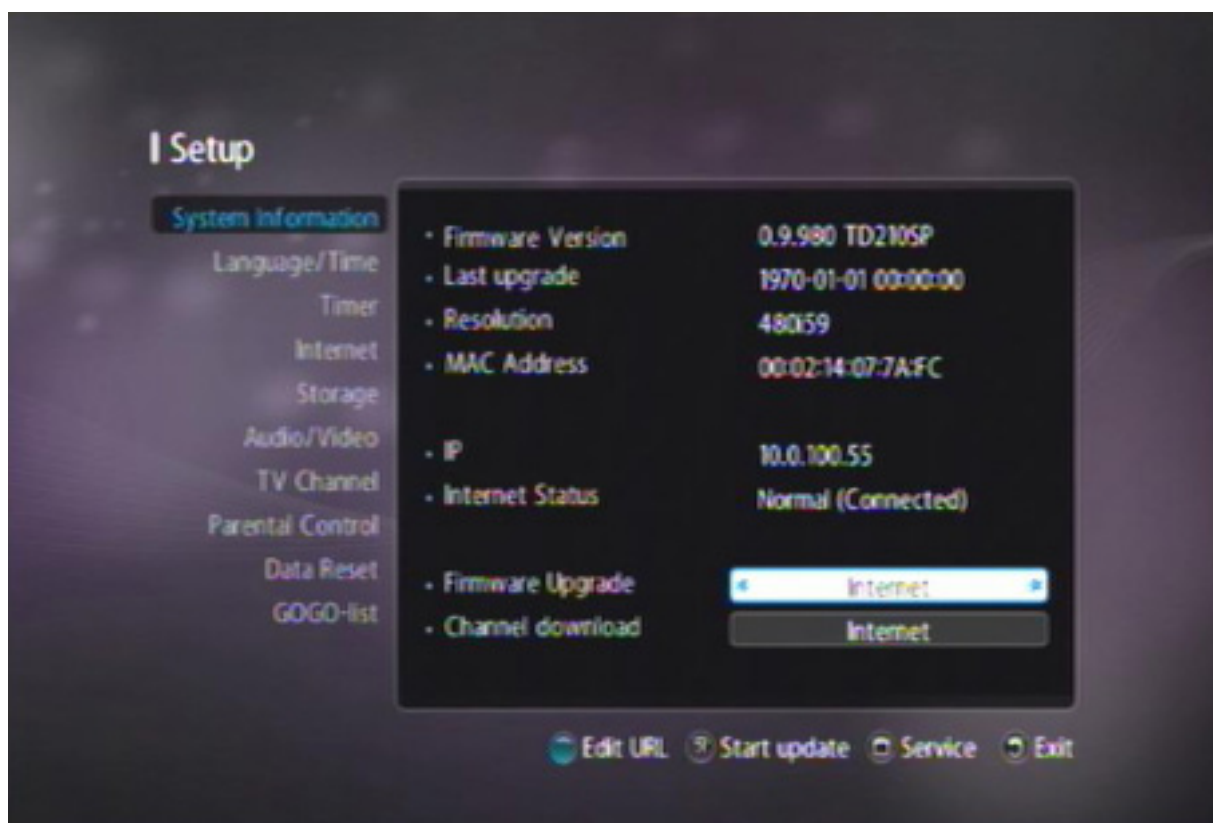

You have to check up the firmware information of your digital receiver before downloading a new firmware. Select the Settings > System Information menu. Check the Firmware Version and Last upgrade option, and you can upgrade your firmware through the Internet, USB or Ethernet.

NOTE

The version of firmware is always the latest version when you purchase the digital receiver.

2.5.1.1 Internet

You can update the firmware through the Internet. Make sure that the digital receiver is connected to the internet before running the firmware upgrade. Press the OK(OK) button, and the Update List will be shown.



If your firmware is the latest version, you don't have to upgrade your firmware.

2.5.1.2 USB Storage

If you have a USB memory stick, you can update the firmware from it by performing the following steps:

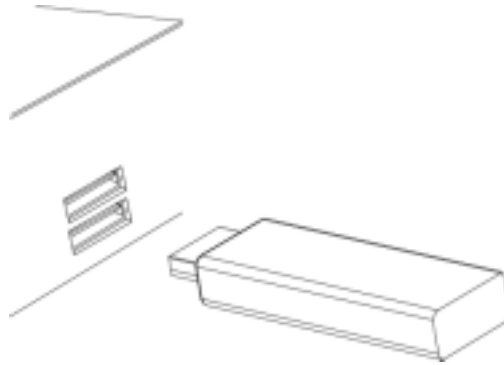

Download a new firmware from the Azbox web site.
Copy the firmware file to your USB memory stick.
Insert the USB memory stick into the USB port of the digital receiver.
Select the Settings > System Information > Firmware Upgrade menu, then the files in the USB memory are listed.
Place the highlight bar on the right firmware version and press the OK(OK) button.
The receiver will be rebooted automatically to upgrade your firmware.
Please wait for the installation.
After installation, the receiver will be rebooted again. Now you can use the receiver with upgraded version.



NOTE

Your USB memory must be formatted in the FAT file system.

Otherwise, the digital receiver cannot recognize your USB memory. In addition, the digital receiver can only recognize files and directories which are named with only **alphabetic, numeric and underscore letters**. If there is a file or folder named with other letters, the digital receiver cannot recognize not only it but also its subsequent files and folders.

3. Settings

If it is first time using the receiver, you will need to set the correct parameters for the system configuration. The settings menu is to set all the parameters for the equipment you are using.



3.1 System Information

You can check the current information of the digital receiver from this menu; Firmware Version, Last upgrade, Resolution, MAC address, (Azbox Premium also shows MAC wireless address if you have), IP and Internet status.

You can also upgrade your firmware version or download channels through the Internet, USB or Ethernet. To upgrade your firmware, see § 2.5.

3.2 Language/Time settings



You can select the language in which the menu would be displayed. In addition to that, you can select the language of audio track and of subtitle track. Select the Setting > Language/Time menu.

3.2.1 Menu Language

The digital receiver supports many Menu Languages: English, Portuguese, Dutch, Korean, and so forth. Set the Menu Language option to your desired language. Once you select a language, the menu will be immediately displayed in the selected language. The default setting is English.

3.2.2 Audio Language / Sub audio language

The digital receiver supports many Audio / Sub audio languages: English, Portuguese, Dutch, Korean, Turkish, German, French, Spanish, Greek, Slovenian, Swedish, Finnish, Italian, Danish, Russian, Polish, Czech, Hungarian, Bosnian, Croatian, Serbian, Macedonian, Rumania, Ukrainian, Bulgarian, Ukraine, Latvian, Norwegian, Lithuanian, Estonian, Slovak, and so forth.

Set the Audio Language and the Sub Audio Language option to your desired languages. When you watch a program, if the program has an audio track of the language that is designated for the Audio Language, it will be output. If the language is not available but the sub language is available, the audio of the sub language will be output.

3.2.3 Subtitle language

Set the Subtitle Language option to your desired language. When you watch a program, if the program has a subtitle track of the language that is designated for the Subtitle Language, it will be displayed. If there is not any available language, no subtitle will be displayed.

3.3 Local time setting

You should set your local time for timer events. If you do not set the local time correctly, the program time table provided by the program guide may be distrustful. For the program guide, see § 4.1.3.1.



Select the Setting > Language/Time menu. You should see a screen like the figure above.

You can set the clock: Manual, Air, Internet, or use the time signal, Greenwich Mean Time(GMT), carried as part of the digital television broadcast. The default setting is Internet.

To use Greenwich Mean Time, take the following steps:

Set the Time Offset option to the time difference between your time zone and GMT referring to Table 3.3.

Make sure that your local time is correctly displayed on the Local Time option.

To set the local time manually, set the Mode option to Manual and enter your local time to the Time option with the Number buttons. The time format is day/month/year 24-hour:minute.

If daylight saving time is observed in your state at the moment, set the Daylight Saving Time option to Yes. The default setting is NO.

NOTE

Daylight saving time adds one hour to the time when the option is set to Yes. When setting the time offset from Greenwich Mean Time, make sure that time offset does not include daylight saving time.

Table 3.3: Time offset table

Time / offset / City
GMT - 12:00 Eniwetok, Kwajalein
GMT - 11:00 Midway Island, Samoa
GMT - 10:00 Hawaii
GMT - 09:00 Alaska
GMT - 08:00 Pacific Time US, Canada
GMT - 07:00 Mountain Time US, Canada
GMT - 06:00 Central Time US, Canada, Mexico City
GMT - 05:00 Eastern Time US, Canada, Bogota, Lima
GMT - 04:00 Atlantic Time Canada, La Paz
GMT - 03:30 Newfoundland
GMT - 03:00 Brazil, Georgetown, Buenos Aries

3 Settings

GMT - 02:00 Mid-Atlantic
GMT - 01:00 Azores, Cape Verde Islands
GMT London, Lisbon, Casablanca
GMT + 1:00 Paris, Brussels, Copenhagen, Madrid
GMT + 2:00 South Africa, Kaliningrad
GMT + 3:00 Baghdad, Riyadh, Moscow, St. Petersburg
GMT + 3:30 Tehran
GMT + 4:00 Abu Dhabi, Muscat, Baku, Tbilisi
GMT + 4:30 Kabul
GMT + 5:00 Ekaterinburg, Islamabad, Karachi, Tashkent
GMT + 5:30 Bombay, Calcutta, Madras, New Delhi
GMT + 6:00 Almaty, Dhaka, Colombo
GMT + 7:00 Bangkok, Hanoi, Jakarta
GMT + 8:00 Beijing, Perth, Singapore, Hong Kong
GMT + 9:00 Tokyo, Seoul, Osaka, Sapporo, Yakutsk
GMT + 9:30 Adelaide, Darwin
GMT + 10:00 Eastern Australia, Guam, Vladivostok
GMT + 11:00 Magadan, Solomon Islands, New Caledonia
GMT + 12:00 Fiji, Auckland, Wellington, Kamchatka

3.4 Timer

With timers, you can turn your digital receiver on or off whenever you wish. Once you have set the timer, the receiver will operate automatically. Timer Menu allows you to select the timer number, state, cycle, service, and the operation time.

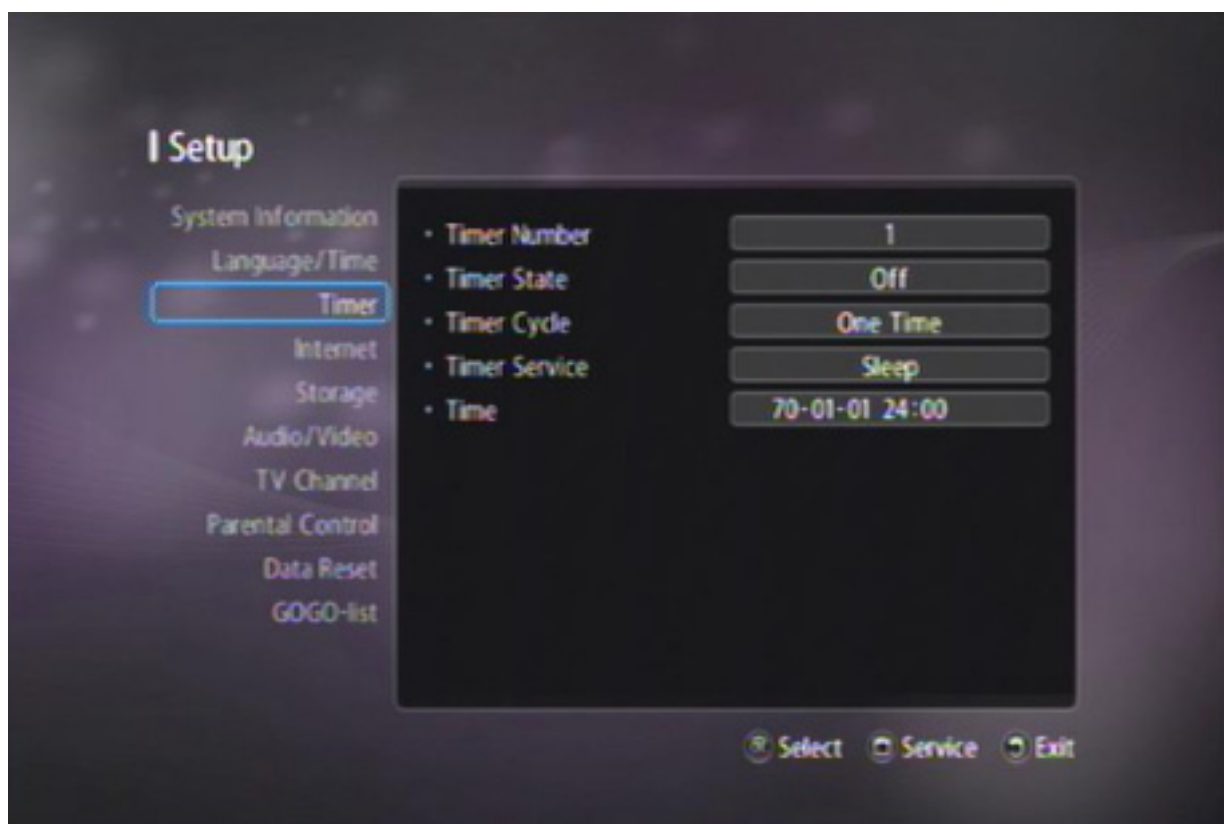

3.4.1 Timer Number

The Maximum number of timers is 8. If all of the timers have been used you will have to erase an existing timer before a new timer can be set.

3.4.2 Timer State

You can choose the use of the selected timer. Each timer can be turned on or off.

3.4.3 Timer Cycle

Each timer can be programmed to occur at various time intervals. There are four timer modes:

One Time means literally 'one time'

Every Day means literally 'every day'

Weekdays means 'Monday to Friday'

Weekend means 'every Saturday and Sunday'

3.4.4 Timer Service

You can choose the operation of the selected timer. Each timer can be selected sleep or wake up.

3.4.5 Time

Enter the time for the receiver to automatically sleep or wake up. Press the number buttons to set time. A timer must be at least 5 minutes long to activate. The time format is day/month/year 24-hour:minute.

3.5 Internet



3.5.1 Network

: Wi-Fi, Wired network. The default setting is Wired network.

To use WIFI, you need to set Wi-Fi and press the OK(OK) button. For 802.11b/g specification, see **Appendix A**.

3.5.2 IP Setting

: Dynamic IP(DHCP), Static IP. The default setting is DHCP.

DHCP: IP-subnet mask and Gateway are not used because the DHCP

server assigns these parameters.

To apply DHCP,

1. In IP setting option, choose DHCP IP and press the OK(OK) button.
2. Select the setup below to apply the configuration.

Static IP: The system's IP-address, IP-subnet mask and Gateway must be specified in the IP-address.

To apply Static IP,

1. In IP setting option, choose Static IP and press the OK(OK) button..
2. Input information IP address, subnet, gateway, DNS1 and DNS2
3. Select the setup below to apply the configuration.

3.5.3 Speed Check

You can check the speed of your current internet connection here.

3.6 Storage



3.6.1 Device

Device option shows the list of the devices(HDD or USB) which connected to your digital receiver. P(number) means the number of the device's partition. To delete partition, press the Delete Partition() button.

3.6.2 Partition

Partition option shows the status of selected partition.

3.6.3 Partition Format

To use the device with the digital receiver, you need to format it before using it. Delete all partitions of the device you want to use, and select Format with the OK() button. You cannot divide partition in this menu.

3.7 Video and audio settings



You have to configure the video and audio settings appropriately for your television set and other appliances. Select the Setting > Audio/Video menu. You should see a screen like the left figure.

The picture format for an HDTV is a combination of screen format and video resolution and is different for normal-screen and wide-screen HDTVs.

3.7.1 Video Format

You can choose the video format: PAL or NTSC

PAL for Europe and North America and NTSC models for North America.

The default setting is PAL.

3.7.2 Video resolution

Your receiver can transmit pictures to your TV in a range of resolutions.

Generally, higher screen resolutions give better quality pictures.

However, if your television set does not support high definition, you

cannot enjoy high definition quality picture. The digital receiver

supports various video resolutions from 480 to 1080. The default setting is 576i50.

You must make the appropriate TV Display Capability settings on your receiver, so that it is compatible with your TV. In order to display the best picture every time, you should select every resolution that your TV is capable of displaying. This should ensure that programs are displayed with the minimum distortion.

While watching television you can change the resolution with the Resolution() button. Whenever you press it, the video resolution is changed in turn.

3.7.3 Screen Format

The TV that you have connected to your set-top has an aspect ratio (width-to-height ratio) of 4:3 (basic/standard) or 16:9 (widescreen). You must set the appropriate TV Aspect Ratio on your set-top, so that it is compatible with the TV.

Two settings are available: 4:3 and 16:9. You should set the TV Aspect Ratio to 4:3 or 16:9 as appropriate. If you have a wide-screen television, set the Screen Format option to 16:9. Otherwise, if you have a normal-screen television, set the Screen Format option to 4:3. The default setting is 4:3.

3.7.4 Display Format

If you set it to LetterBox option, wide-screen pictures then will be reduced to fit to the width of the normal screen. Otherwise, set it to FullScreen, then wide-screen pictures will be cut out on the left and right sides equally to fit to the width of the normal screen. The default setting is FullScreen.

3.7.5 Video Output

You can choose the video output: CVBS(composite) or RGB(component). The default setting is CVBS.

3.7.6 Default Audio Format

You can choose the default audio format: AC3 or off. The default setting is Off.

3.7.7 Audio Output

You can choose the audio output: Stereo, Left(Mono) or Right(Mono). Basically, there are two audio sources as you can find two audio sockets on the back panel of the digital receiver. You can enjoy only one source or both of them in either Stereo, Left(Mono), and Right(Mono). Set the Sound Output option as you desire. The default setting is Stereo.

3.7.8 Dolby Output

The digital receiver can output two types of digital audio signals via the S/PDIF connector. One is an encoded signal, and the other is a decoded signal. If your digital audio system does not have a Dolby Digital decoder, you have to set the Dolby Output option to Uncompressed. Otherwise, set it to Compressed. The default setting is Uncompressed.

NOTE

If the service you are currently watching does not provide Dolby digital, you cannot watch the program with Dolby sound even though you set the Dolby Output option to Compressed.

3.7.9 RF Channel Number

You can choose the RF channel number: 21 to 69.

Your TV must be set to this channel in order to view the output of your receiver. If this channel is currently being used as a broadcast channel or if you are getting interference on this channel, you may change the channel to an unused number. Then change your TV to that channel in order to view the output. The default setting is 21.

3.7.10 RF Audio Type

You can choose the RF audio type. The default setting is B,G 5.5Mhz.

3.8 TV Channel



3.8.1 Antenna Setup



The Antenna Setup menu controls all the parameters for your installation. Ensure that your satellite receiver is correctly connected to your television and dish, and that your satellite signal is of good quality by checking the Strength and Quality meter. (If you are not sure about this, then ask your installer to check your installation or satellite signal). If all of the above parameters are set correctly, you will be able to see both of the Strength Signal (blue bar) and Quality (red bar) level at the

top of the menu.

NOTE

A minimum level of stable signal Quality is required to be able to search and view the channels.

3.8.1.1 Satellite Name

1. Select the satellite you want to program. Scroll through the various satellite using the Navigation() buttons and select the appropriate satellite by press the OK() button.
2. When you select the satellite by pressing the OK() button, the satellite will be selected and that satellite's default parameters will appear.
3. You can adjust the LNB Frequency, DiSEqC, 22KHZ Tone, 0/12V Switch, LNB Power, TP Frequency, Positioner Setup and Network Search. The displayed information can be adjusted for each selected satellite.

3.8.1.2 LNB Frequency



To scan channels, you must select the correct LNB type that you have on your dish. The default value is for the Universal LNB. Select the proper LNB type using the buttons according to the LNB type you are using.

3.8.1.3 DiSEqC

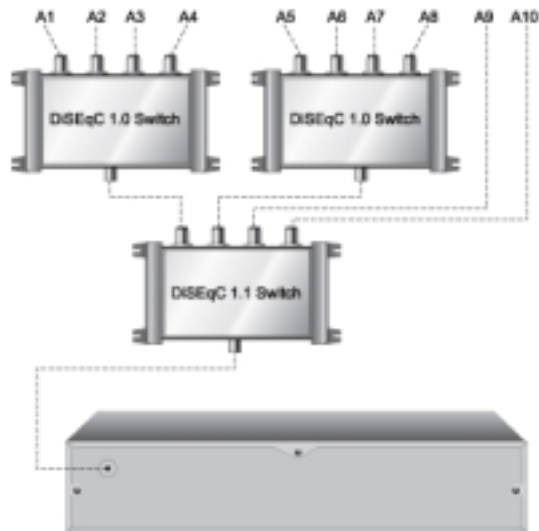



3.8.1.4 22KHZ Tone

22KHZ Tone option is set to OFF for each LNB type, but can be turned ON. If the LNB Frequency is set to Universal, you do not have to use this option.



3.8.1.5 0/12V Switch

You can select the option between 0V and 12V.

3.8.1.6 LNB Power

Set LNB power ON or OFF by using   buttons.



3.8.1.7 TP Frequency

Select a specific transponder by using the   buttons, or pressing the OK() button. to view the drop-down list.

3.8.1.8 Positioner Setup

3.8.1.8.1 DiSEqC 1.2

This mode will allow you to set the antenna position for each satellite. In order to use antenna positioner you must use a motor controlled by DiSEqC 1.2 commands.

To move the antenna, select the desired satellite, transponder and step size. Then select Move Dish and press the   buttons to move the antenna West or East. If you selected Continuous for the step size, the antenna will move continuously until you press another key. Once the antenna is positioned properly (maximum level in the quality meter), select Command Mode and choose save. Press the OK() button to save the position. The position number will be displayed next to the satellite name.

When you want to move the antenna to a saved satellite position, select the satellite, choose Go To Position from the Command Mode and press

the OK(OK) button. To clear a saved satellite position, select satellite, then choose Resetting from the Command Mode and press the OK(OK) button.

Setting and enabling East and West limits that the dish can move to is done.

Setting East Limit: Move the dish to the most eastern position and press the OK(OK) button to store it.

Setting West Limit: Move the dish to the most western position and press the OK(OK) button to store it.

The Limit options are only active if you select Enabling Limits. They are not active if you select disable Limits.

NOTE

Limits do not need to be set if you have no obstacles or barriers preventing your dish from the full range of the motor.

3.8.1.8.2 USALS

This mode will allow you to use a DiSEqC 1.3/2.3 motor controlled by USALS(Universal Satellite Automatic Location System).

The first time you select USALS, you must enter your location (longitude and latitude). You can also edit the satellite's position. This will be necessary if you add a new satellite because it will be set to zero by default.

Select Go To Position option and press the OK() button in the Command Mode to move the dish to the satellite position.

Select Go To 0 option and press the OK() button in the Command Mode to move the dish to the 0 position.

NOTE

When scrolling through the satellite list in the Antenna Setup menu, the dish will start to move when you highlight a satellite that has the Positioner Setup set to DiSEqC 1.2 or USALS (assuming that a DiSEqC 1.2 or USALS motor is connected to your dish). You can avoid this by returning the Positioner Setup to the OFF state.

3.8.1.9 Network Search

Some of the new transponders being broadcasted in the satellite could be missing in the given TP list. In this case, there is a good chance that the information of those new transponders are being sent through the given TP. So, if you set the Network Search to 'NIT' status and search that TP, then you will be able to catch the channels in those new transponders.

3.8.2 Satellite Scan

Satellite can be scanned directly from the Satellite Scan menu, Select Satellite Scan menu and press the OK(OK) button.



Scroll through the satellite dropdown list, and select a satellite by pressing the OK(OK) button. When you press the OK(OK) button to start process, you will be given four options in the search criteria: TV channels, Radio channels, FTA (Free-to-air) channels and Scrambled channels. You can select or deselect any of the options.

Using the Check() button, you can select more than one satellite.

3 Settings

Once you have selected the desired satellites, press the OK(OK) button to start searching those satellites. The receiver will search all satellites selected with the Check(📡) button.

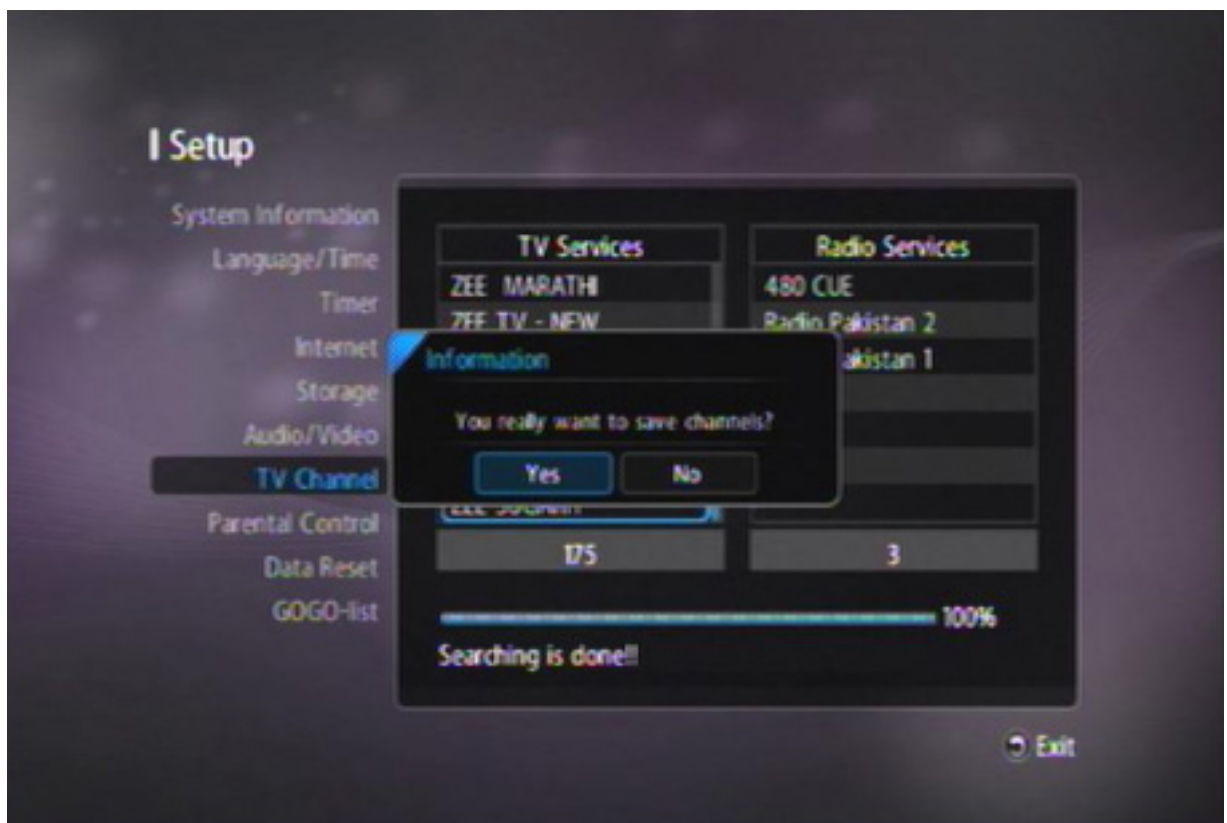

To save the searched channel list, press the OK(OK) button.

3.8.3 TP Scan

Individual transponders(TP) can be scanned with TP scan. Scroll through the satellite dropdown list, and select the satellite to be scanned. Using the Check(📡) button, you can select more than one satellite.

3.8.4 Advanced Scan

The channel search procedure can be performed in different ways. Start by selecting the satellite to be searched in the Advanced Scan menu.

The TP frequency can be entered manually by using the Number buttons, or selected from the dropdown list that appears when you press the OK(OK) button while highlighting the Frequency field. After entering TP frequency, symbol rate and polarization, modulation, FEC and Pilot, move the highlight bar to TP Search and press the OK(OK) button to start searching channels.

TP Frequency: Specify the frequency in MHz.

Symbol Rate: Enter with the Number buttons.

Polarization: Select Horizontal or Vertical.

Modulation: DVB-S/QPSK, DVB-S2/QPSK or DVB-S2/8PSK.

FEC: Select FEC(Forward Error Correction) value or leave as Auto.

Pilot: 0 or 1.

3.8.4.1 PID Edit

Use this in case of a specific Transponder which has non-DVB standard channels and which can only be found when you have entered the necessary settings. You can also add or delete channels from a specific TP.

1. PCR: Enter the PID(Packet Identifier) for the PCR(Program Clock Reference).
2. Video: Enter PID for the video signal.
3. Audio: Enter PID for the audio signal.

3.8.5 SAT/TP Edit

In this menu, you can add/delete the satellites or transponders.

3.8.5.1 Add satellite (TP)

Press the Add Satellite() button to add a new satellite(or TP) to the receiver. Enter the new satellite(or TP) name and position. The new satellite(or TP) will be added to the bottom of your list.

3.8.5.2 Delete Satellite (TP)

Choose the satellite(or TP) you want to delete and press the Delete Satellite() button. You will be asked to confirm that you want to delete the satellite(or TP) before it is deleted.

3.9 Parental control

In general, television programs are classified according to the level of violence, nudity and language of their content. You can prevent your children from watching specific programs by adjusting Parent control option. In parental control menu, you can set the censorship classification or change the password.

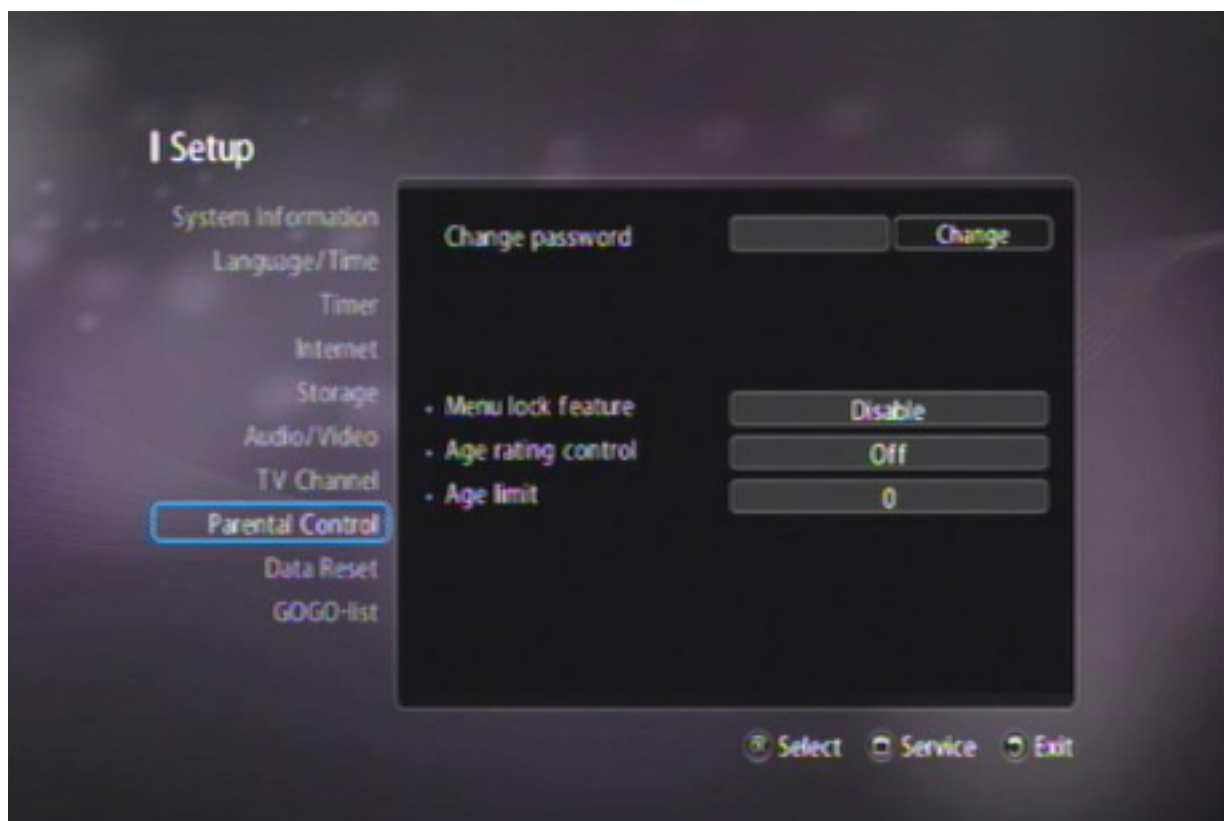

3.9.1 Change password

Select the Setting > Parental Control menu. You should see a screen like the left figure, and you will be asked your Password.

The default password is set to '0000'.

To change the password, select the Change password menu; enter your previous password inside the white box and select Change. Then an input box appears. You can change the password to a desired number. If anyone is trying to watch a program that is of or above the censorship setting, the person has to enter the personal identification number to override.

NOTE

DO NOT FORGET YOUR PASSWORD.

3.9.2 Menu lock feature

You can also restrict uses of some menus. When you select Enable, you have to enter the personal identification number when accessing any menu screens where values can be changed. This can prevent users from accidentally changing the settings. To release a shut item, set it to Disable. The default setting is Disable.

3.9.3 Age rating control / Age limit

If you wish to block 15 or above rated programs, set the Age rating control option to On, and Age limit option to 15(age). Setting it to 0 blocks no program.

When you are watching a program, you can check its program classification on the information box.

NOTE

If a program does not have any program classification information, your censorship setting will not take effect.

3.10 Data Reset

The digital receiver maintains the following data:

- Satellite list
- Services list
- Favorite list
- Timer list
- Preference settings

You can reset all data of the digital receiver. Before you enter the data reset option, you must input your password.

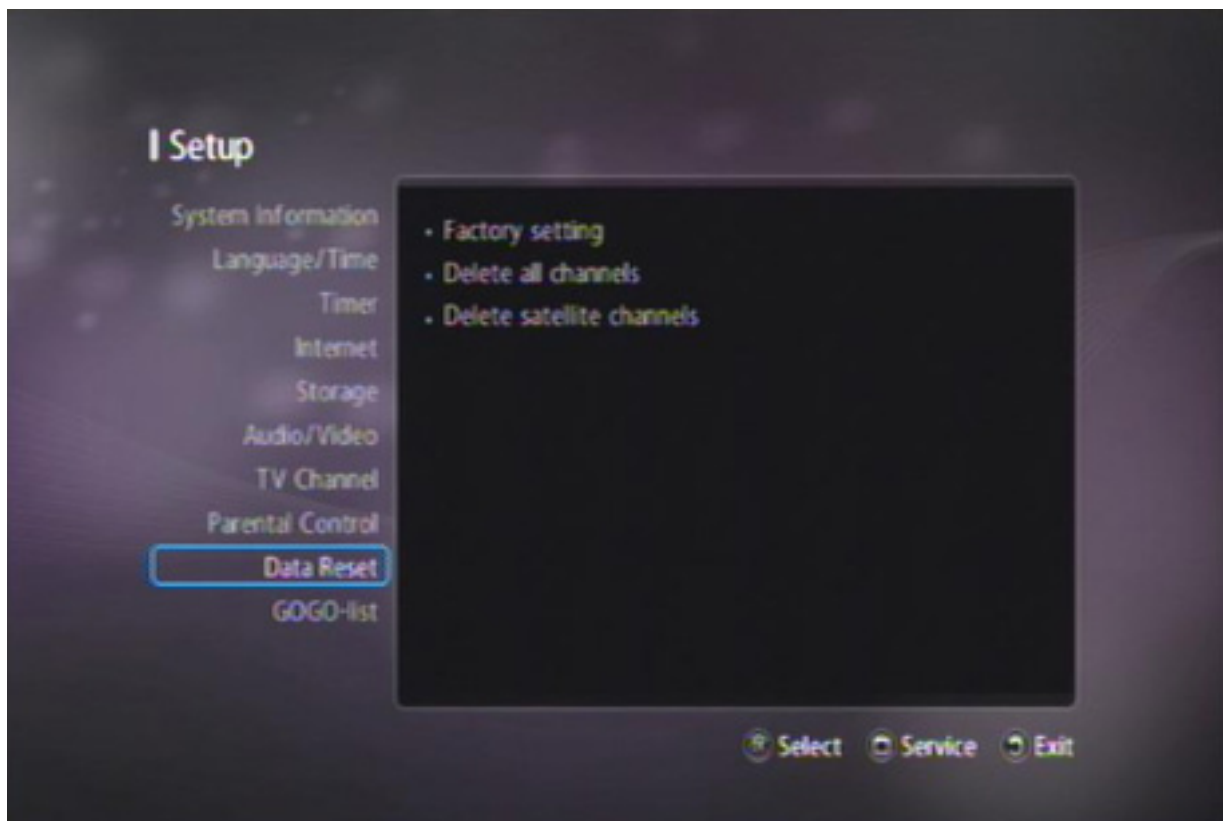

3.10.1 Factory setting

If you need to reset the digital receiver back to the factory default

condition, select Factory setting. Then a warning message will be displayed. To confirm, select YES. All satellite and transponder lists will be set to the factory default. On selecting factory setting you will lose all of the data and information, which was previously installed.

NOTE

A factory reset will not delete any recorded programs.

3.10.2 Delete all channels

All channels, for all satellites will be deleted.

3.10.3 Delete satellite channels

Delete only the channels for a specified satellite.

3.11 GOGO-list



Bandwidth
All, C-Band, Ku-Band
Satellite Name

4.Main Menu

To open Main Menu, wherever you are, press the Home(🏠) button on your remote control.







4.1 TV

4.1.1 Watching television

4.1.1.1 Changing Channels





You can change channels in three ways:

Press CH \wedge /v on the front panel, or press CH \wedge /v ( ) or   on the remote control to change channels.

Press the OK () button while using the channel selection.

Enter the number of the channel you want to tune using the number buttons on the remote control.

4.1.1.2 Adjusting the Volume

Press VOL +/- on the front panel, press VOL +/- ( ) or   on the remote control to step through the channel selection. When you adjust the volume, the volume scale is displayed on the screen.

4.1.2 Channel Selection

To view the Channel Selection, press the OK(OK) button.



On the services list, you can see the service information:

- Service number and name
- Transmitting satellite
- channel Information.
- Transponder information

To watch a desired channel, put the highlight bar on its entry with the Navigation buttons and press the OK(OK) button, then it will be presented. You can switch between the television services list and the radio services list by pressing the TV/Radio (TV/RADIO) button.

If you press the Info(Info) button while you use the channel selection,

the single EPG of the channel will be shown. See § 4.1.3.1.1 for more details.

4.1.2.1 How to sort the channels

You can sort the channels; ALL, Satellite, Genre, Provider, Country, FTA/CAS, and FAV.



ALL: show the all channels you can watch.

Satellite: sort the channels by satellite. Then only services provided by the selected satellite will be listed.

Provider: sort the channels by provider. you can view service entries by groups of broadcasters.

FTA/CAS: sort the channels by FTA, CAS, and HD.

FAV: sort the channels by your preference. See § 4.1.2.2 for more details.

You can arrange the channels in each category; alphabet() , frequency() and default() . Select the mode among the three modes that you want to sort and press the button on the remote control. In alphabetical order, you can search the channels with the Number buttons. See § 4.2.1 for how to use the on-screen keyboard.

4.1.2.2 Favorite channel lists

The Favorite channel list (FAV) function is used to organize your channel list and create and edit your favorite channels. The Maximum number of FAV groups is 50. And 200 channels per each group.

To select a favorite service, put the highlight bar on a desired group and press the OK(OK) button; a highlight bar appears on its favorite services list.

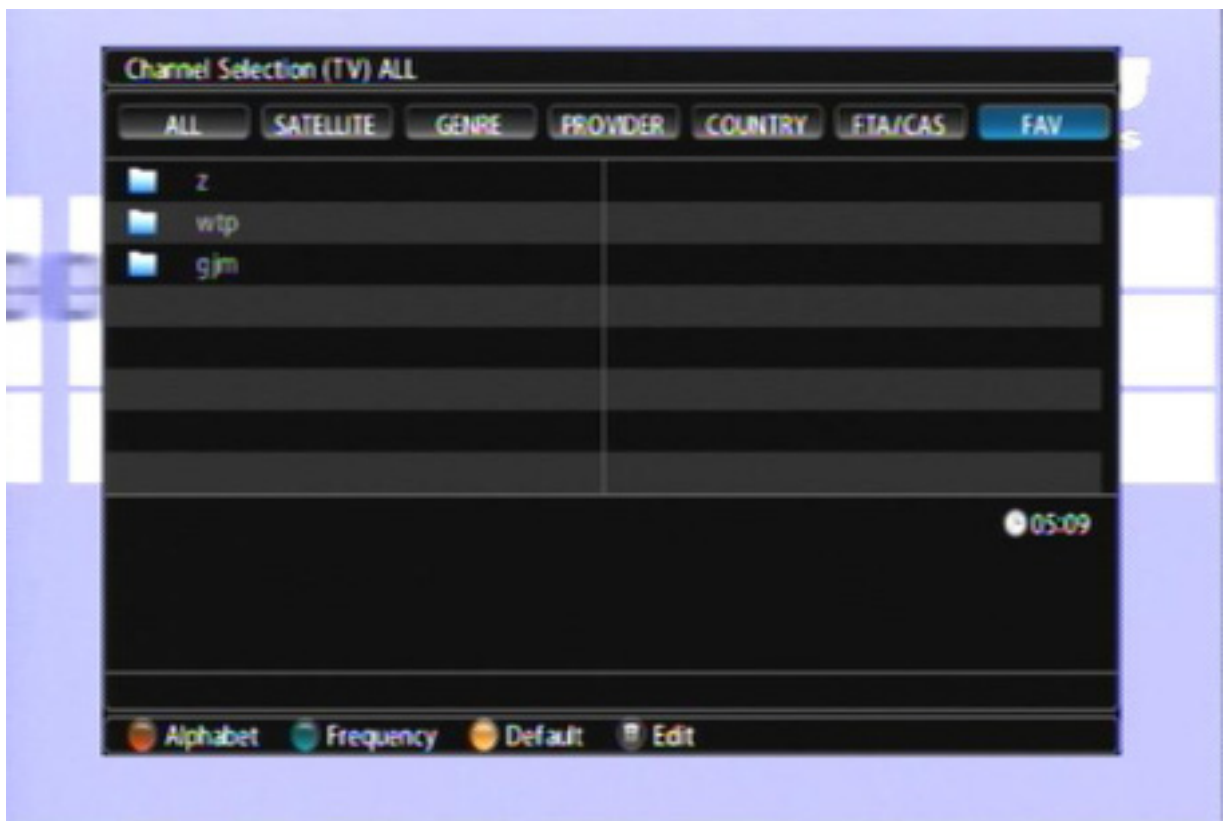

Once you select a desired service with the OK(OK) button, it will be presented. Otherwise, to select other group, press the Exit(Exit) button. After you have selected a favorite service, if you then switch to another service using the (Up) or (Down) button, it will be also another favorite

service of the selected group.

4.1.2.3 Channel Edit

To edit the channel, press the Menu() button; Lock, Skip, Delete, Add to favorite, Insert HD flag, Rename, and MOVE.

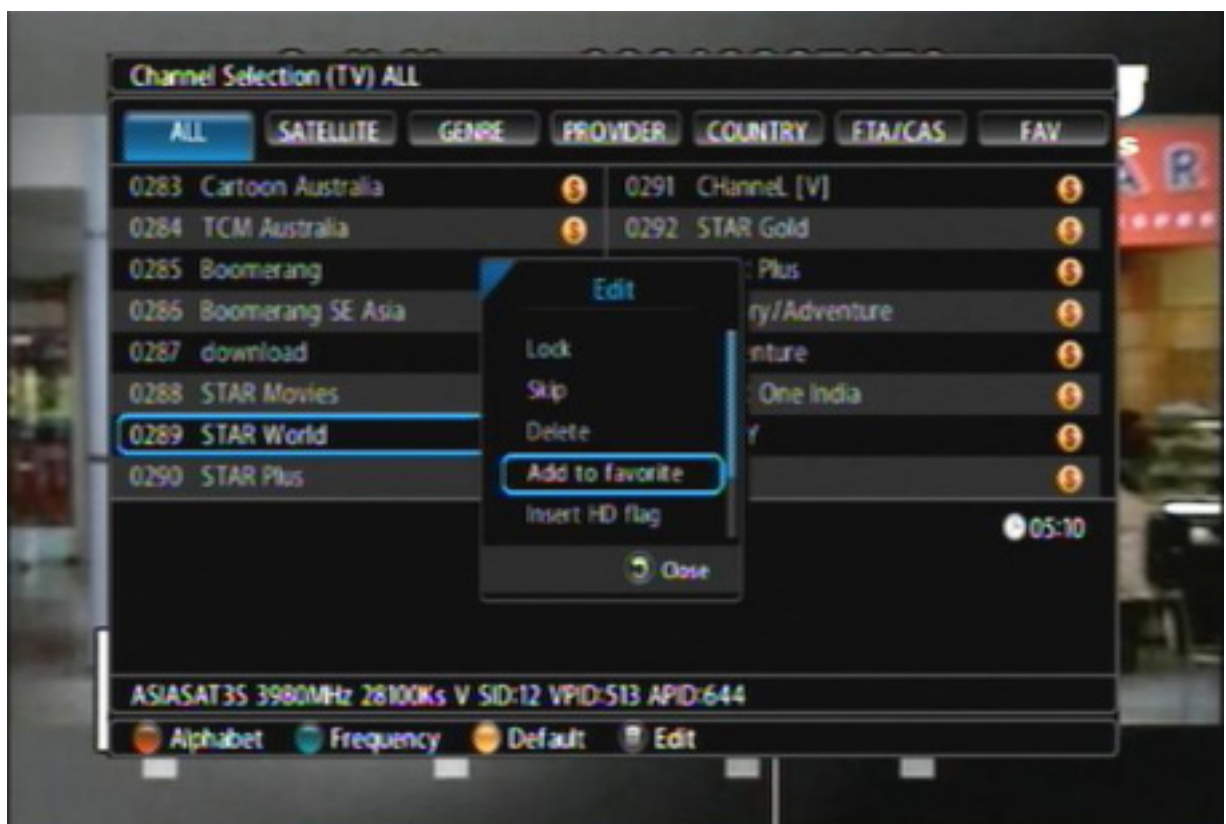

Lock: Lock channels. To watch the locked channel, you must enter your password.

Skip: Skip channels. But you can watch the channel by press its channel number.

Delete: Delete channels from the channel list. The deleted channel cannot be recovered unless you do a channel scan again. See §

3.7.2 for more details.

Add to favorite: Add channels into your favorite list. Put the highlight bar on a desired group and press the OK() button.

Insert HD flag: Insert the HD flag to channels.



Rename: Change the name of the highlighted service, See § 4.2.1 for how to use the on-screen keyboard.

MOVE: Move channels to a different position, in FAV category only.



4.1.2.4 Program Information

Pressing the Info() button displays the information box, on which you can see all of the following:

- Service number and name
- Signal level and quality
- Program name
- Program classification symbol
- Broadcasting time
- Current time

Pressing the Info() button once more displays detailed information about the current program. To hide the information box, press the Exit() button.

In addition, you might see the following symbols:



- Lock symbol() means the current service is locked.
- Subtitle symbol() means subtitle tracks are provided on the current program.

Teletext symbol() means teletext pages are provided on the current service.



Dollar symbol() means the current service is a pay service.

Number symbol( or number) means the censorship classification of the program.



Dolby symbol() means a Dolby audio track is provided on the current program.

When you are not using time-shift, if the EPG is provided on the current service, you can see the information about the current and next programs with the  or  button.

4.1.2.5 Selecting subtitle lists



Some programs are provided with subtitle lists in one or more languages. If the current program provides subtitle tracks, the subtitle symbol() will be marked on the information box. Pressing the Sub-T() button displays available subtitle tracks. Once you select a subtitle track, it will be displayed.

4.1.2.6 Viewing Teletext

The display of teletext is based on transmitted data using the EBU Teletext specification and DVB Bitmap and can only be viewed on a TV that supports teletext. If the current service provides teletext, the teletext symbol() will be displayed on the information box. Press the Text() button to view teletext pages. Each menu shows short information at the bottom of the screen.

To clear the teletext screen, press the Exit() button.

4.1.2.7 Selecting audio lists

Some programs are provided with audio lists in one or more languages. Pressing the Lang() button displays available audio tracks. Once you select an audio track, it will be sounded. You can change the audio output with the   buttons when it is available.

4.1.3 EPG (Electronic Program Guide)



4.1.3.1 EPG (Electronic Program Guide)

The TV/Radio EPG(Electronic Program Guide) provides an overview of available TV and Radio channels, and programs the broadcasters have scheduled for now, next and beyond, depending on which program information they transmit. To display EPG, press the Guide() button on the remote control.

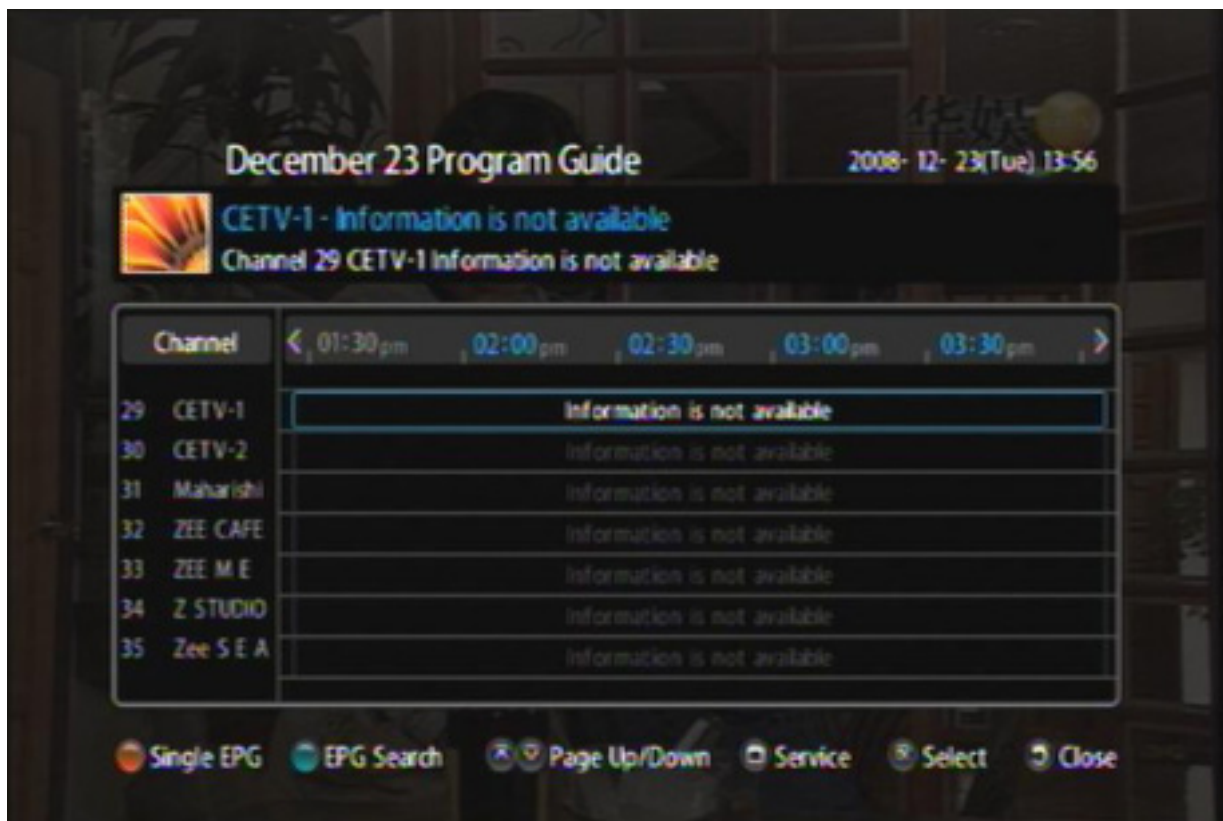

To see detailed information of a desired program, put the highlight bar on the program with the navigation button and press the Info() button.

To watch the selected program, press the OK() button. The selected program will appear when it is broadcasting. If not, you can reserve to record or watch the channel. See § 4.1.3.2.3 for more details.

NOTE

- For displaying EPG, you will need to set Timer option in SETUP menu.
- A 'Information is not available' message is displayed if the selected channel has not obtained EPG data.

4.1.3.2 Single EPG

Single EPG shows the program schedule of the selected channel. To see single EPG, press the Single EPG() button.

4.1.3.3 Search EPG

To search EPG, press the EPG Search() button. Enter the keyword that you want to search and choose either or both of these options; title and description.

4.1.4 PVR (Personal Video Recorder)

NOTE

Azbox Elite/Premium does not support the video cassette recording. Due to the Macrovision Copy Protection v.7.01, the recorded program can be distorted.

4.1.4.1 PVR

4.1.4.1.1. Internal HDD (Azbox Premium)

HDD should be mounted manually.

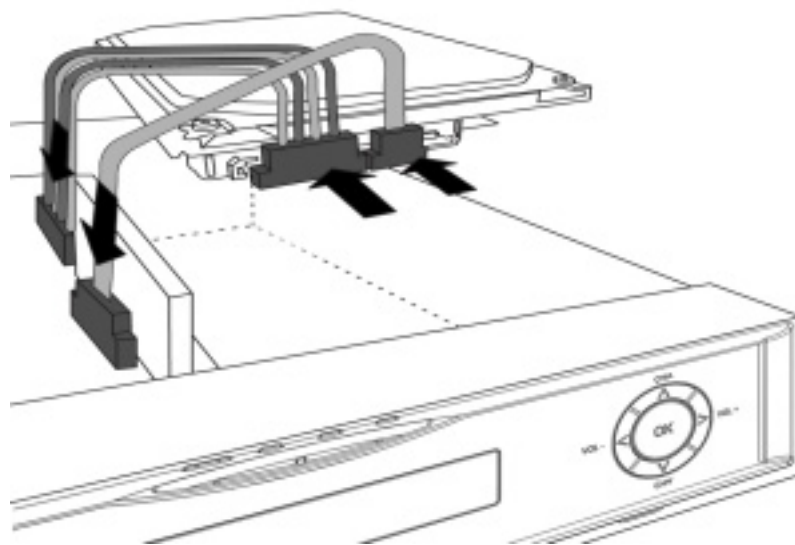

4.1.4.1.2 PVR Ready (USB) – (Azbox Elite/ Azbox Premium)

When you use USB devices such as USB hard-disk drive (HDD) and USB memory stick, or internal hard-disk drive (HDD) with this receiver, you should make sure that the HDD be formatted in **FAT file system, not NTFS.**

If you try to record TV channels on USB Memory stick, it may not support recording and timeshift properly.



In case you use NTFS formatted HDD,

- (a) PVR features are not supported.
- (b) The receiver may not boot-up properly.
- (c) Even with FAT formatted USB HDD, please connect it to your receiver only after the receiver completed booting.
- (d) If you power on/off the receiver with the NTFS formatted USB device connected to the receiver, STB may get damaged or may not start properly.

4.1.4.2 Record Live TV

You can instantly record the program you are watching at present. If the information about program is provided by the EPG, the current recording will stop when the current program is scheduled to end. If not, it will record for 2 hours.

To record a program, take the following steps:

1. Press the REC() button during the program or select Record in the detail menu.
2. Choose the device you want to record and select Yes.
3. To stop recording or extend the recording time, press the REC() button again or select Record Stop in the detail menu.

4.1.4.3 Reserve Record/Play

You can set a service to be recorded or turned to the channel at a specific time.

Channel: select the channel you want to record.

Part: Record or Play.

Repeat: Once, Mon to Fri, Mon to Tue, Wed to Thu, Daily or User Select. If your favorite program is broadcast at every Monday and Tuesday and you wish to record every episode of the program, set this option to Mon to Tue.

Start Date/Time: set the desired start date and time.

Duration: set the desired time, in which the recording will be finished; 10 minutes to 3 hours.

Target: HDD or USB.

Program: The recorded program will be stored with this name.

To set a reserve recording with the above settings, select Reservation.
Otherwise, it will not be saved and will not occur.



NOTE



- In normal TV viewing mode the Reserved Program alert banner will appear on the screen before a reserved program starts.
- You cannot record and play the programs which are being broadcast at the same time.

4.1.4.4 Reserve recordings using the EPG

If the EPG is properly provided, you can make reserve events on it. The instructions on how to make reserve recordings using the EPG are as follows:

Display the EPG in the Detail Menu.

Select a service you want to record with the  and  buttons.

Select a program you want to record with the  and  buttons, and press the OK() button.

To make a timer event with recording, select record and choose the device you want to record to. To make a reserve event without recording, select play.

This reserve event is placed on the reserved program menu. To delete the reservation, refer to § 4.1.3.4 for detailed description.

4.1.4.5 Recording a pay service program

To record a pay service program, you have to record the program with the subscription card so that they can be recorded in descrambled form. In that case you can enjoy them without the subscription card like free services.



To record a program of a pay service in descrambled form, perform the following steps:

1. Select a program of a pay service you want to record.
2. Make sure that the subscription card is inserted in the slot of the digital receiver.
3. Start recording.
4. Do not switch to other service nor use time shift until it is finished.



NOTE

If you switch to other service or use time shift in the middle of recording a pay program, it will be recorded without descrambling from that moment. Even if the recording is only partially descrambled, you need the subscription card to play it back.

4.1.4.6 Recorded Program

When a program is recorded, it is stored as a file on the built-in hard disk drive of the digital receiver or USB memory stick. You can select a recording to play back from the recorded program list. Choose the device with the  buttons, and select the files with the  buttons on the remote control. Using the Check () button, you can select more than one file to play in a list. Every devices has its own list. You can play, delete, change the preservation time, copy and move a recording file.





4.1.4.7 Reserved Program

The Reserved Program option displays date, channel, program and section for the programs currently reserved by the viewer. To delete a reserve event, check the items you want to remove with the Check() button, and press the Menu() button. If you select delete selection, they will be deleted.

4.1.4.8 Time-Shift

You can pause and resume a live television program, and even rewind and replay it. When you are watching a program and you miss something, you can rewind and replay it. Or when your attention is needed elsewhere, you can pause it and resume it a short time later without losing any of it. When you do this, you are no longer watching the live program, instead you are watching a delayed presentation of it. This is called time shifted television.

Then, you can skip commercials until you catch up to the live broadcast. In order to use the time shift feature, the Time Shifting option must be set to HDD or USB. The digital receiver will keep as much as one hour recording buffer of current service by utilizing the device. The buffer will reset each time you change to another service. With time shift enabled, the following operations are possible:

- To go back in time, hold down the  button; to go forward, hold down the  button.
- You can navigate using the progress bar.
- You can jump forward 10 seconds at a time by pressing the  button.
- You can jump backward 10 seconds at a time by pressing the  button.
- The time difference compared to live program is displayed momentarily in bottom of screen. A value of - 02:00 means two minutes behind live program.

- To end time shift, press the  button. The live program will be presented.

NOTE

Do not remove the USB while recording a program or using the time-shift. It may cause disorder.

4.2 YouTube

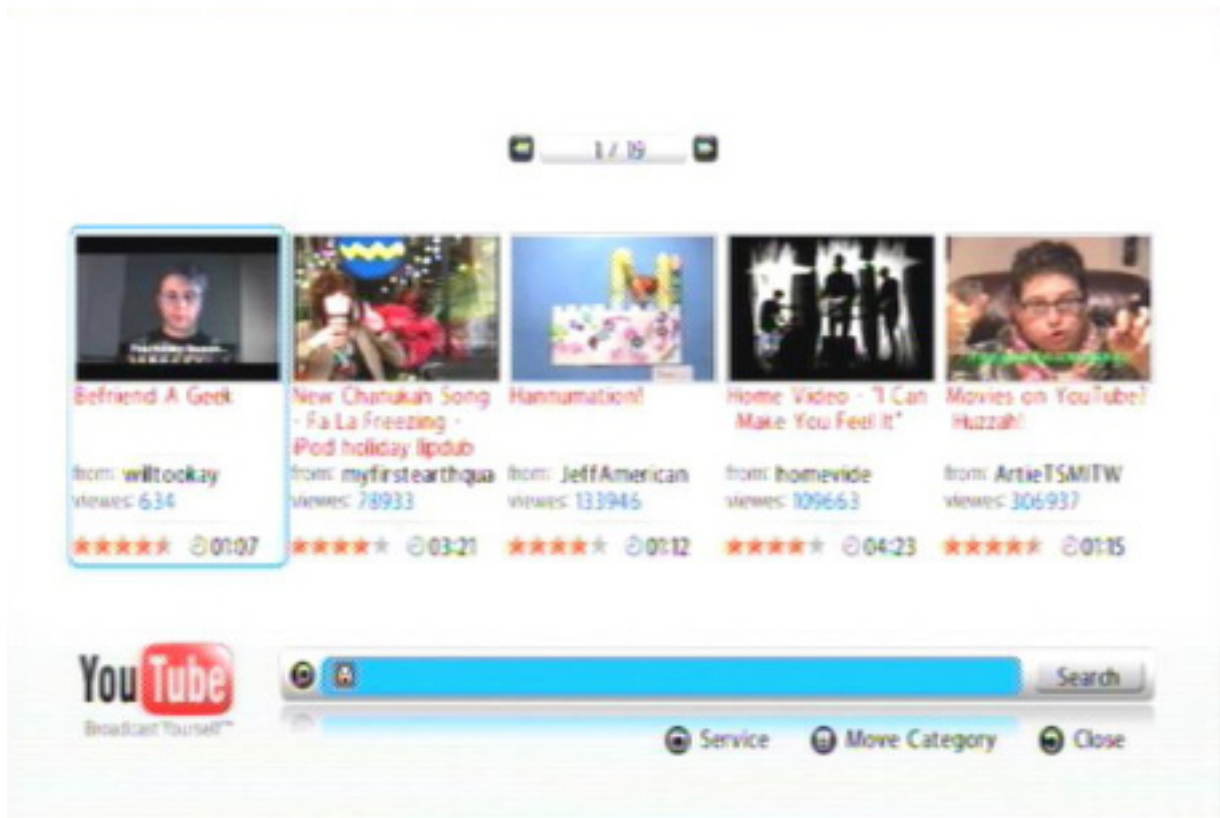

4.2.1 How to search in the YouTube



Press the Search(**P**) button. Enter search text in the box that appears and press the OK(**OK**) button on the remote control. The system will list all entries that contain the entered letter combination.

When accessing an input field where letters are required, the system automatically goes to letter mode. Writing letters works like on a mobile phone. Press the button that corresponds to your desired letter.

Press the button as many times as needed to get the right letter.

Change to lower, upper case letters or back to numbers with the CAP/NUM() button, and space with the  button.

NOTE

How to write "Azbox 123" in the input field:

Press the  button once to change to upper case letters

Press the  button once to get an "A".

Press the  button twice to change to lower case letters.

Press the  button three times to get a "z".

Press the  button twice times to get a "b".

Press the  button three times to get an "o".

Press the  button twice to get an "x".

Press the  button once to get space.

Press the  button twice to change to Number.

Press the  button once to get a "1".

Press the  button once to get a "2".

Press the  button once to get a "3".

4.2.2 Load Video Lists

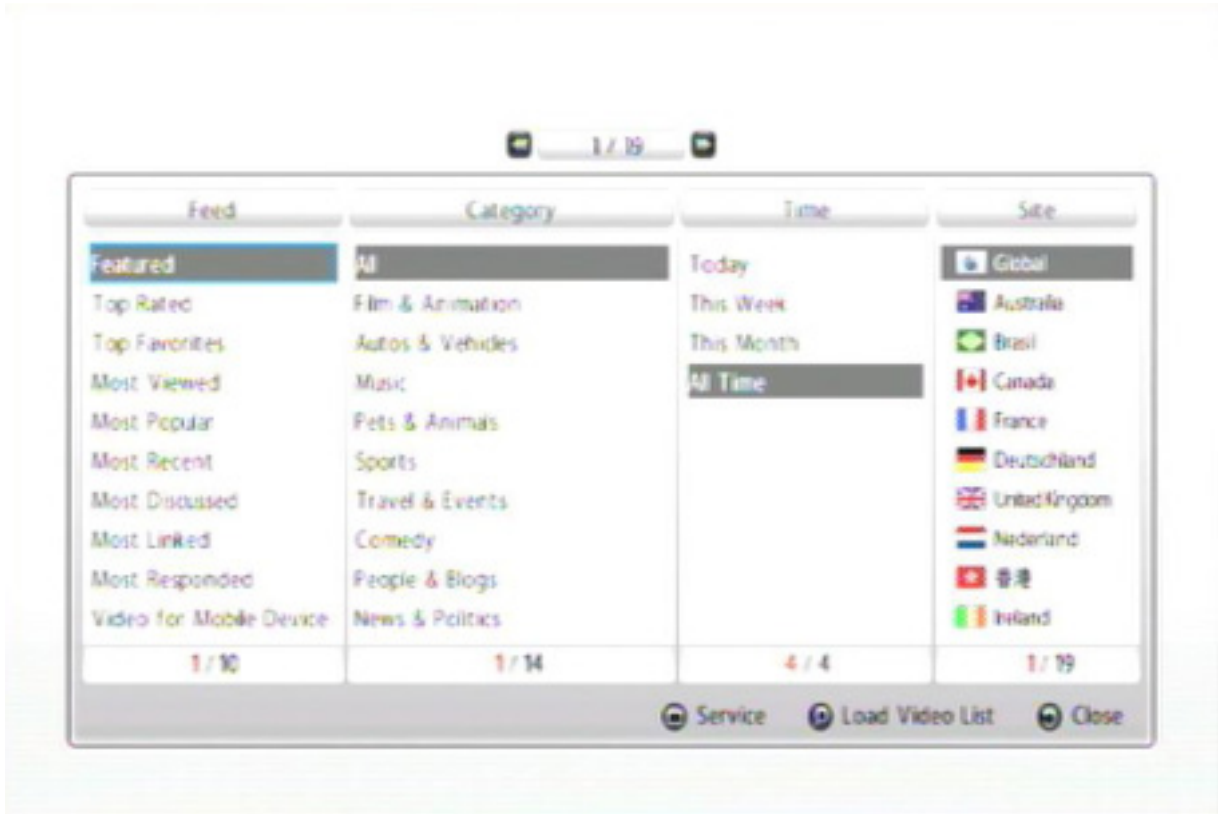

You can also search the UCC (User Created Contents) for your interest. Press the Menu (☰) button and select Feed, Category, Time and Site. The default setting is [featured / all / all time / global]. When you press the Search (🔍) button on remote control, the receiver will show the list based on your preference.



4.3 File Play & Management

There are two different ways to play video/audio/photo file from your device.

- HDD: If HDD is connected to IDE inside the box, user may use this function to play local files in hard disk drive.
- USB: If USB device is connected to external USB port, user can play files stored in the USB device.

4.3.1 Movie / Music / Photo

If you want to run the files that stored in your device, select Movie, Music or Photo menu.

The screen shows up the supported files stored in the HDD. Move the cursor to the file to run and press the OK() button. If the file that you want to play is in other folder or device; TV record, Download, Network or USB, move your cursor to the device and press the OK() button.

Using the Check() button, you can select more than one file to play in a list.

You can change the several options in the detail menu.

4.3.1.1 Movie

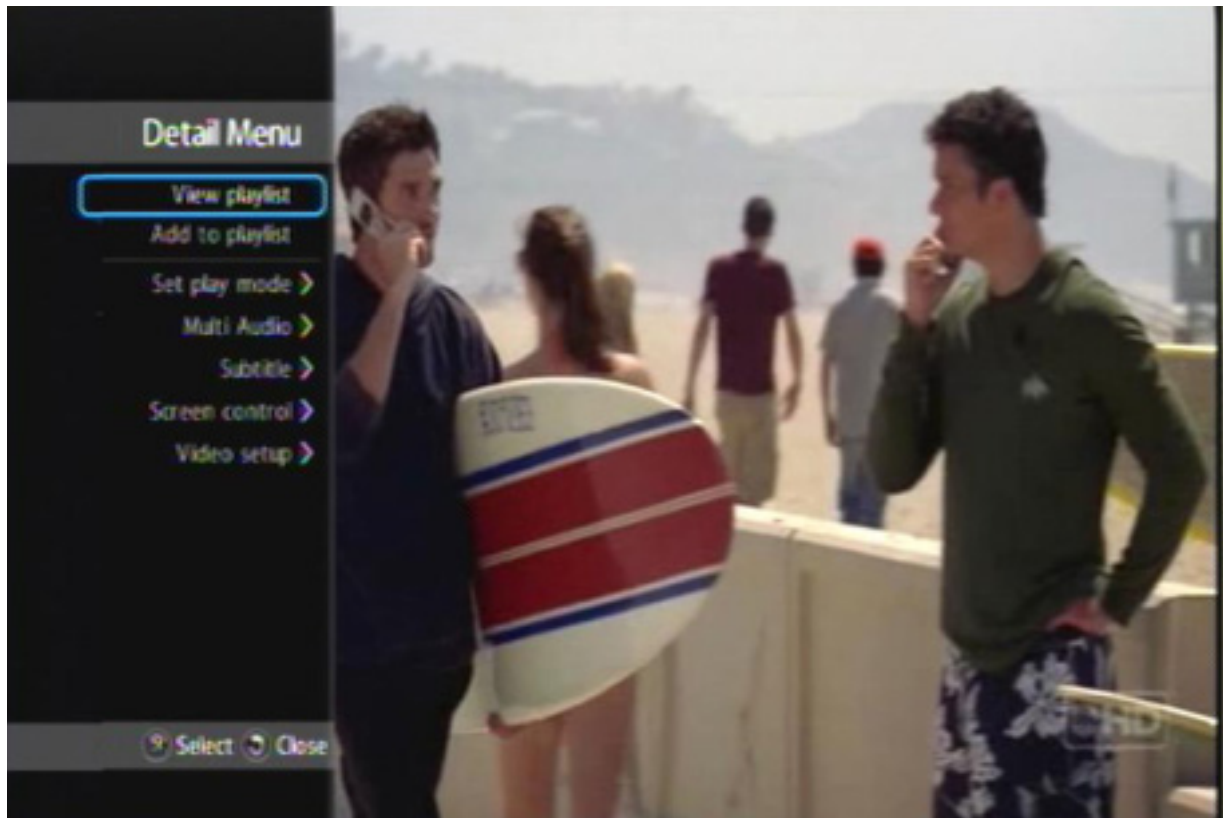

Set play mode: Play once or Repeat.

Multi audio: Select Audio

Subtitle: Select Position, Size, View, Sync and Language.

Screen control: Brightness, Saturation, Contrast, Hue and Zoom.

Video setup: Full or Auto.

4.3.1.2 Music



Set play mode: Standard play, Repeat, Repeat all or Random.

4.3.1.3 Photo



Image optimization: optimize the selected image.

Start slideshow: Pictures will automatically slide in every 5 seconds.

My Album: Create your own album.

Arrange: You can arrange the images by its Name, Date or Size.

File View: List, Thumbnail or Tile.

4.3.2 File Management

In file management menu, you can not only play all supported files, but also create folder, rename or copy files.





Folder option: Create folder, Rename and Arrange.

File option: Copy, Cut and Paste.

4.3.2.1 Move files to another folder

To copy, cut and paste files to another folder, perform the following steps:

1. Select files to copy or cut with the Check() button.
2. Press the Menu() button, and select the option you want to perform with the files.
3. Move your cursor to the folder where you want to paste it.
4. Press the Menu() button, and select the paste option.

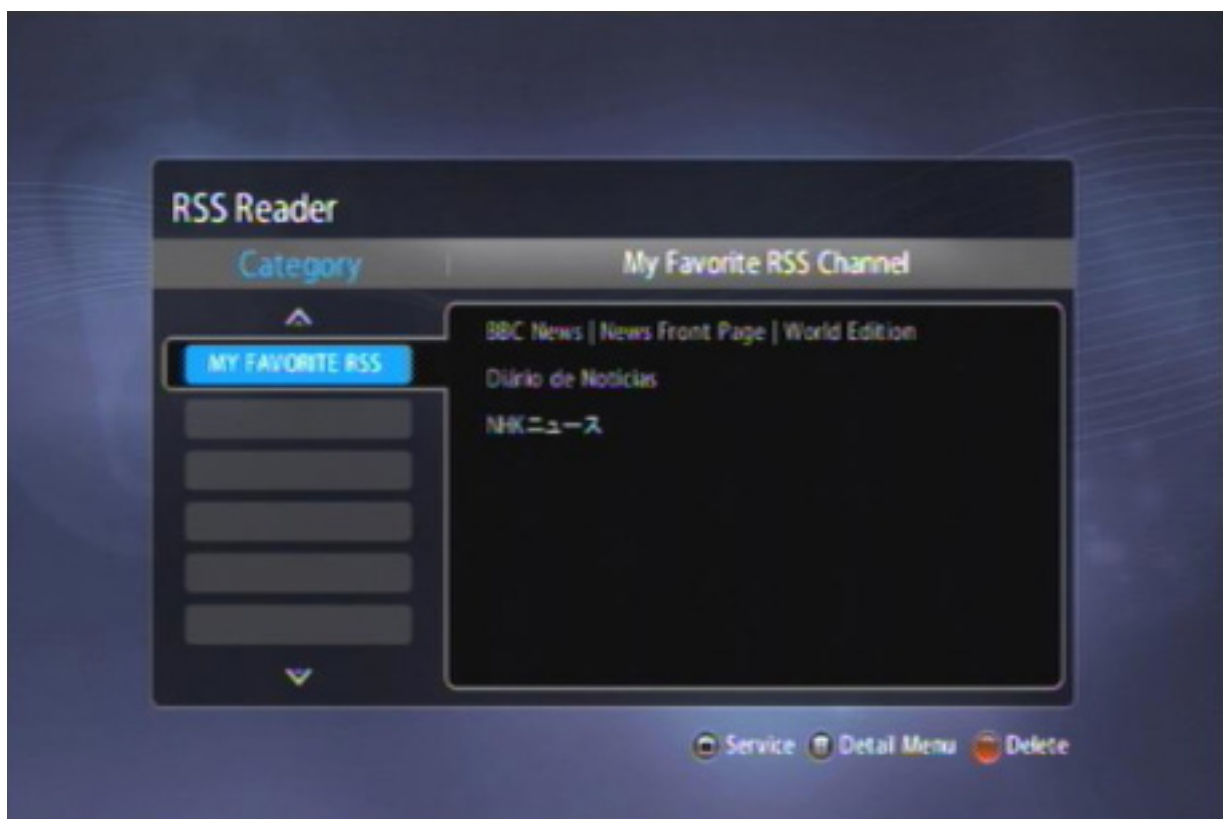

4.4 RSS News

RSS (Rich Site Summary) is a format for delivering regularly changing web content. Many news-related sites, weblogs and other online publishers syndicate their content as an RSS Feed to whoever wants it. RSS solves a problem for people who regularly use the web. It allows you to easily stay informed by retrieving the latest content from the sites you are interested in. You save time by not needing to visit each site individually.





4.4.1 Add new category

To add a new category, take the following steps:

1. Press the Menu() button. Select the Add new category option, and press the OK() button.
2. Enter a new category name in the box that appears and press the OK() button.

4.4.2 Register new channel

To register a new channel, take the following steps:

1. Press the Menu() button. Select the Register new channel option, and press the OK() button.
2. Enter a new RSS address in the box that appears and press the OK() button.

NOTE

If you want to delete categories or channels, move your cursor to the category or the channel that you want to remove, and press the Delete() button on the remote control.

4.5 Browser

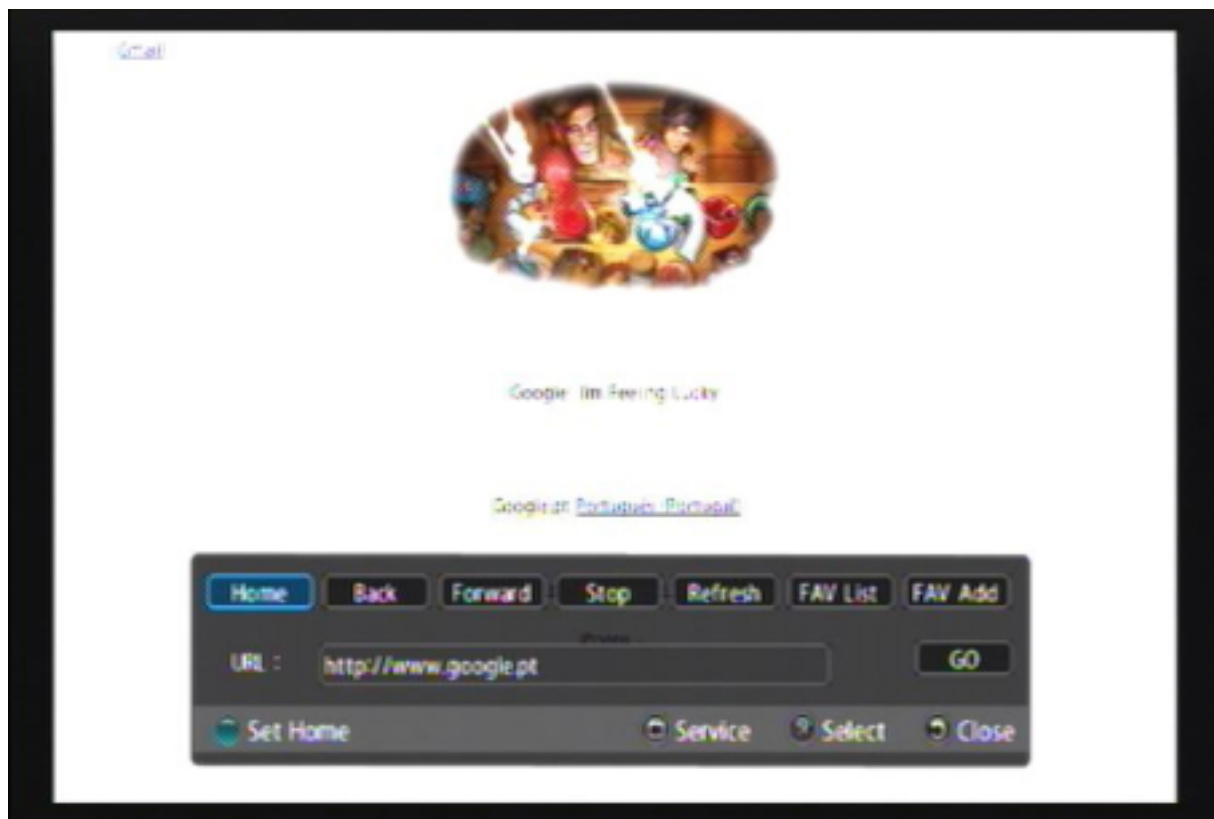

Select Browser on main menu, it will display the default page set in the box. If you want to change the default page, press the Set Home(🟢) button on the remote control. To surf different web page, you can move the cursor to the URL box, and type URL address.

4.5.1 Favorite List

The Favorite list (FAV List) function is used to organize your favorite list and create and edit your favorite sites. To add your favorite site to your list, take the following steps:

1. Select the FAV Add option.
2. Input the site address. See § 4.2.1 for how to use the on-screen keyboard.
3. Press the OK() button to save the site to your favorite list.

5. Network

You can connect the digital receiver to the computer. Then you can copy files to or play files through the network. Before you use the network, the Settings > Internet menu must be set. When you use a Wi-Fi, you should know whether you have a good connection. While the receiver is in stand-by mode, the network runs by itself.

5.1 Connect the digital receiver to the computer

To connect the digital receiver to the computer, take the following steps:

1. Select the Settings > Storage menu.
2. Input the Workgroup, Server, Account and Password option; (if you need password) with the Number buttons on the remote control. See § 4.2.1 for how to use the on-screen keyboard.
3. Move the cursor to Setup and press the OK(OK) button. After the complete message is received, select Execute with the OK(OK) button.
4. Open “My Network” of your computer, then you can see the folder that you already named in step 2.

NOTE

Do not stop the File server active condition while you use the network to send or receive data.

5.2 Connect the computer to the digital receiver.

To connect the computer to the digital receiver, take the following steps:

5.2.1 Windows XP

Computer settings: When you place your mouse on the folder that you want to share and click the right mouse button, you pop up a limited menu of commands. Select the “Share and Security” option.

Check the “Share this folder in Network” option and input the share name. Then select “Confirm” or “Apply”.

Digital receiver settings: Move your cursor to the File Management > Network option, then the receiver will search for the network automatically.

If your receiver cannot find the network automatically, press the Menu() button and select the Edit IP Address option. You can input the computer IP address directly with the Number buttons.

5.2.2 Windows Vista

Computer settings: Select “Start” > “Network”

Select “Common Network(User Define)” and set the option to “Individual”.

In “Share and Search” menu, set the “Network Search” option to “Use”, “Share File” option to “Use”, “Share Folder” option to “Use”, “Share Printer” option to “Use”, “Share protected with Password” option to “Not Use” and “Share Media” option to “Use”.

Check your selection carefully and move to the “My Computer”.

When you place your mouse on the folder that you want to share and click the right mouse button, you pop up a limited menu of commands. Select the Share option.

Add the Everyone(All users in this list) option and choose “Share”.

In “Network Search and File Sharing” item, select the “Network Search and File sharing” option.

Move to “Control Panel” > “Security Center”. And disable firewall of your computer. (You must reboot your computer to adjust it.)

Digital receiver settings: Move your cursor to the File Management >

Network option, then the receiver will search for the network automatically.

If your receiver cannot find the network automatically, press the Menu() button and select the Edit IP Address option. You can input the computer IP address directly with the Number buttons.

6.Product specifications / Warranty

6.1 Product specifications

6.1.1 Power specifications

6.1.1.1 Azbox Elite

Input voltage 110 to 240 VAC, 40Am (SMAPS)
Power consumption 40W at maximum in operation
5W in standby

6.1.1.2 Azbox Premium

Input voltage 11V, 3.4Am / 24V, 800m
Power consumption 60W at maximum in operation
5W in standby

6.1.2 Physical specifications

6.1.2.1 Azbox Elite

Size 300 x 218 x 66mm
Gross Weight 3.12 kg
Net Weight 1.78 kg
Operating temperature 0 to 60 °C
Storage temperature -10°C to +70°C

6.1.2.2 Azbox Premium

Size 340 x 243 x 66mm
Gross Weight (w/o HDD) 2.65 kg
Gross Weight (with HDD) 3.04 kg
Net Weight (w/o HDD) 2.11 kg
Net Weight (with HDD) 2.49 kg
Operating temperature 0 to 60 °C
Storage temperature -10°C to +70°C

6.2 Warranty

6.2.1 Warranty Terms and Conditions

This warranty must be presented at an OpenSat authorized repair service station before any repair can be made under conditions of the warranty. This warranty is valid only if the Warranty Certificate and proof of purchase are presented at the OpenSat repair service station—in addition to the one year Warranty, issued by OpenSat Corporation in the region. Please notice that this warranty is in addition to and does not affect the customer's statutory rights.

6.2.2 Provisions of Warranty

If your product proves to be defective, although it has been used properly (in accordance with the written Handling Care and Operating instructions supplied with it), during a period of one year from the date of purchase from an authorized OpenSat distributor within the business area of OpenSat as stipulated in the authorized distributors list, this product will be repaired, or at OpenSat's option replaced, free of charge. To claim under this warranty the customer must take the product and this Warranty Certificate before the end of the one year warranty period to the dealer where the product was purchased or any other OpenSat Service Center within the business area of OpenSat as stipulated in the authorized distributor list. During the one year period of the Warranty,

the customer may turn the product in at any OpenSat service station. Please note that such OpenSat Service Center do not exist in all countries.

The customer shall transport the product to the dealer or OpenSat authorized service station at his own risk and shall be responsible for any costs incurred in transporting the product.

This warranty does not cover the following, and the customer will be required to pay repair charge, even for defects occurring within the warranty period referred to above:

Any defect that occurs due to mishandling (such as an operation performed that is not mentioned in the Handling Care or other sections of the instructions, etc.)

Any defect that occurs due to repair, modification, cleaning, etc. performed by anyone other than OpenSat or an OpenSat authorized service station.

Any defect or damage that occurs due to transport, a fall, shock, etc. after purchase of the product.

Any defect or damage that occurs due to fire, earthquake, flood damage, thunderbolt, other natural disasters, environmental pollution and irregular voltage sources.

Any defect that occurs due to careless or improper storage (such as keeping the product under conditions of high temperature and humidity, near insect repellents such as naphthalene or harmful drugs, etc.), improper maintenance, etc.

Any defect that occurs due to sand, mud, etc. entering the inside of the product casing.

When this Warranty Certificate is not returned with the product.

When any alterations whatsoever are made to the Warranty

Certificate regarding the year, month and date of purchase, the customer's name, the dealer's name, and the serial number.

When proof of purchase is not presented with this Warranty Certificate.

This Warranty applies to the product only; the Warranty does not apply to any other accessory equipment, such as the Phone cable, Power cord and Phone splitter.

OpenSat's sole liability under this warranty shall be limited to repairing or replacing the product. Any liability for indirect or consequential loss or damage of any kind incurred or suffered by the customer due to a defect of the product, and in particular any loss or damage caused to any power-cords, phone splitters, other equipment or accessories used with the product or for any loss resulting from a delay in repair or loss of data, is excluded. Compelling regulations by law remain unaffected by this.

6.2.3 Notes regarding warranty maintenance

This warranty will only be valid if the Warranty Certificate is duly completed by OPENSAT or an authorized dealer or other documents contain sufficient proof. Therefore, please make sure that your name, the name of the dealer, the serial number and the year, month and date of purchase are all completed or the original invoice or the sales receipt (indicating the dealer's name, the date of purchase and product type) is attached to the Warranty Certificate. OPENSAT reserves the right to

refuse free-of-charge service if neither the Warranty Certificate is completed nor the above document is attached or if the information contained in it is incomplete or illegible.

Since the Warranty Certificate will not be re-issued, keep it in a safe place.

6.2.4 Disclaimer of Warranty

OpenSat makes no representations or warranties, either expressed or implied, by or concerning any content of these written materials or software, and in no case shall be liable for any impelled warranty purchase are all completed or the original invoice or the sales receipt of merchantability or fitness for any particular purpose or for any consequential, incidental or indirect damages (including but not limited to damages for loss of business profits, business interruption and loss of business information) arising from the use of inability to use these written materials or software. Some states do not allow the exclusion or limitation of liability for consequential or incidental damages, so the above limitations may not apply to you.

7. Appendix A. 802.11b/g Specification

802.11b/g channel frequency

Channel ID	FCC (US) (GHz)	ETSI (Europe) (GHz)
1	2.412	2.412
2	2.417	2.417
3	2.422	2.422
4	2.427	2.427
5	2.432	2.432
6	2.437	2.437
7	2.442	2.442
8	2.447	2.447
9	2.452	2.452
10	2.457	2.457
11	2.462	2.462*
12	—	2.467*
13	—	2.472*

*Antenna Gain

- Main

2.4GHz : 2.87

2.45GHz : 2.93

- Aux

2.4GHz : 2.71

2.45GHz : 2.97

*RF Modulation Type

- IEEE 802.11g : BPSK, QPSK, 16QAM, QFDM

- IEEE 802.11b : DQPSK, DBPSK, DSSS, CCK

8. Appendix B. TV Brand List

<< TV Brand List >>				
Brand Name	Setting Number			
A.R.Systems	0037	0352	0556	0374
	0455			
Accent	0009	0037	0556	
Acer	1339			
Adcom	0625			
ADL	1217			
Admiral	0093	0363	0418	0163
	0264			
Adyson	0216			
AEA	0037	0556		
AEG	1556	0606	1163	
Agashi	0216	0264		
AGB	0516			
Aiko	0009	0037	0556	0216
	0371	0035	0433	0361
	0191	0264		
Aim	0037	0412	0556	0753
	0208	0706	0805	
Aiwa	0701	1908	1505	
Akai	0361	0208	0371	1537
	0037	0433	0745	0191
	0035	0009	0753	0218
	0729	0714	0163	0516
	0715	0602	0556	0548
	0480	0631	0216	0264
	0178	0377	0606	1037
	1908	0473	0648	1259
	1935			
Akashi	0860	0009		
Akiba	0218	0282	0455	0037
	0556			

Akira	0418			
Akito	0037	0556		
Akura	0037	0556	0668	0412
	0009	0218	0282	0264
	0714	1982		
Alaron	0216			
Alba	0037	1037	0556	0714
	0009	0418	0370	0371
	0668	0355	0218	0216
	0247	0163	0487	0036
	1908	0443	1935	
Alkos	0035			
All-Tel	0865			
Allstar	0037	0556		
Amplivision	0370			
Amstrad	0009	0516	0264	0371
	0218	0037	0556	0433
	0412	0362	1037	0648
	1982			
Anam	0037	0556	0009	0650
AnamNational	0037	0556	0650	
Andersson	1163	1149		
Anglo	0009	0264		
Anitech	0009	0264	0037	0556
	0282			
Ansonic	0370	0037	0556	0009
	0668	0374	0163	0411
	0247	1437		
Apollo	0473			
ArcenCiel	0109			
Arcam	0216			
Ardem	0486	0714	0037	0633
	0556			
Aristona	0556	0037		
ArthurMartin	0163			
ASA	0105	0346	0070	

Asberg	0037	0556		
Asora	0009			
Astra	0037	0556		
Asuka	0218	0216	0264	0282
ATD	0698			
Atlantic	0037	0556	0216	
Atori	0009			
Auchan	0163			
Audiosonic	0009	0037	0374	0820
	0556	0109	0714	0715
	0370	0264	0218	0486
Audioton	0486	0370	0264	
Audioworld	0698			
Autovox	0247			
AVP	1908			
AWA	0011	0036	0009	0374
	0412	0037	0556	0216
	0606	0108	0264	1376
Axxent	0009			
Axxon	0714			
B&D	1217			
Baird	0109	0193	0343	0073
	0208	1196		
Barco	0163			
BasicLine	0374	0037	0163	0668
	0556	0009	0218	0282
	0455	0339	1037	
Bauer	0805	0009		
Baur	0009	0535	0195	0512
	0037	0556	0191	0361
	1505			
Beaumark	0178			
Beko	0714	0035	0486	0370
	0037	0418	1037	0556
	0606	0715	0808	
Belson	1191	0894		

Bennett	0556	0037		
BenQ	1756			
Beon	0037	0556	0418	
Berthen	0668			
Best	0370			
Bestar	0037	0556	0370	0374
Bestar-Daewoo	0374			
BlackDiamond	1163	0820	1037	0556
	0821	0753		
BlackStar	0247			
BlackStrip	0035			
Blackway	0282	0218		
Blaupunkt	0191	0535	0195	0200
	0327	0328	0455	0170
	0036			
BlueSky	0037	0714	1037	0487
	0668	0715	1909	0556
	0218	0282	0455	1908
	1191	0808	1363	
BlueStar	0282			
Bondstec	0247			
Boots	0009			
Bosch	0327			
BPL	0037	0556	0282	
Brandt	0625	0109	0287	0335
	0343	0560		
Brandt_Electronique	0287	0335		
Brinkmann	0037	0556	0668	0519
	0418	0486		
Brionvega	0037	0556	0362	
Britannia	0216			
Brother	0264			
Bruns	0486			
BSR	0163	0361		
BTC	0218			
Bush	0668	0218	0163	0009

	0036	0037	0371	0282
	0355	0363	0374	0519
	0264	0361	1037	0487
	0208	1556	1259	0698
	0556	0714	1900	1908
	0778			
Canton	0218			
Capsonic	0264			
Carad	0610	0037	0556	0668
	1037			
Carena	0455	0037	0556	
Carrefour	0036	0070	0037	0556
Carver	0170			
Cascade	0009	0037	0556	
Casio	0037	0556	0163	
Cathay	0037	0556		
CCE	0037	0556		
Celestial	0819	0820	0821	
Centrex	0780	0891		
Centrum	1037			
Centurion	0037	0556		
Century	0247			
CGE	0074	0084	0418	0247
	0370	0163		
Cimline	0009	0218		
Cinex	0648	1556		
City	0009			
Clarivox	0418	0037	0556	0070
Clatronic	0037	0370	0371	0714
	0218	0264	0556	0247
	0009	0648	0606	1163
Clayton	1037			
CMS	0216			
Cobolt	0891			
Combitech	1908			
Concorde	0009			

Condor	0037	0556	0370	0216
	0009	0282	0247	0418
	0411	0163	0264	
Conia	0754	0821	0894	0820
Conrac	0808			
Conrad	0037	0556		
Contec	0216	0009	0011	0036
	0264	0037	0556	
ContinentalEdison	0109	0287	0487	
Cosmel	0009	0037	0556	
Crosley	0247	0074	0084	0163
Crown	0009	0712	0370	0486
	0037	0556	0487	0714
	0606	0715	0418	0208
	0653	0339	1037	
CSElectronics	0216	0218	0247	
CTC	0247			
CTX	1756			
CurtisMathes	0093			
Cybertron	0218			
Cytronix	1298			
D-Vision	0037	1982	0556	
Daewoo	0634	0374	1909	0499
	0661	0037	0556	0009
	0216	0218	1137	1908
	0880	1307	1598	0865
Dainichi	0218	0216		
Daitsu	1267			
Dansai	0037	0556	0264	0035
	0216	0009	0036	0208
Dansette	0412			
Dantax	0370	0486	0714	0606
	0715	1908		
Datsura	0208			
Dawa	0009	0037	0556	
Daytek	0698	1207	0706	1376

Dayton	1207			
Daytron	0009	0374	0037	0556
deGraaf	0208	0163	0548	0363
DEC	0795	0860	0891	
Decca	0516	0037	0556	1137
	1908			
Deitron	0037	0556	0374	0218
Denko	0264			
Denver	0037	0556	0606	1189
	0587			
DER	0193			
Desmet	0037	0556	0009	
Diamant	0037	0556		
Diamond	0264	0698	0009	0825
	0216	0371	0860	0820
Digatron	0037	0556		
Digihome	1149			
Digiline	0037	0556	0105	0668
DigiLogic	0037	0556		
Digitex	0820			
Digitor	0037	0556	0861	
Digivision	0361			
DigiX	0880			
DiK	0037	0556		
Dixi	0009	0037	0556	0247
DL	0891	0780	0037	0587
	0865			
Domeos	0668			
Domland	0394			
DreamVision	1704			
DSE	0861	1556	0820	
DTS	0009			
Dual	0343	0519	0037	0556
	0352	0394	0163	1137
	0631	1149	1037	
Dumont	0070			

Dunai	0163			
Durabrand	0037	1437	0556	
Dux	0037	0556		
DVX	0891			
Dynatron	0037	0556		
EasyLiving	1248	1259		
Ecco	0773	0706		
Edison-Minerva	0487			
Elbe	0435	0362	0370	0163
	0037	0556	0218	0191
	0411	0610	0516	0361
Elbe-Sharp	0516			
Elcit	0247	0516	0163	
Elekta	0009	0037	0556	0264
	0282			
Elfunk	1208	1037		
ELG	0037	0556		
Elin	0216	0037	0556	0105
	0548	0361	0163	0009
Elite	0218	0037	0556	
Elta	0009	0264	0216	
Emco	0247			
Emerson	0714	0178	0247	0037
	0556	0371	0070	0282
	0361	1909	0486	0370
	0163	0668		
Emperor	0282			
Enzer	0753			
Erres	0037	0556		
ESC	0037	0556		
Est?le	0163			
Etron	0001	0037	0556	0009
	0163	0820		
Eurofeel	0264			
EuroLine	0037			
Euroman	0216	0264	0037	0556

	0370			
Europa	0037	0556		
Europhon	0037	0516	0163	0556
	0247	0216		
Evesham	1248			
Excel	0037	0556		
Expert	0163			
Exquisit	0037	0556	0247	
Fagor	0037	0556		
FairTec	1191			
FamilyLife	0037	0556		
Fast	1901			
Fenner	0374	0009		
Ferguson	0073	0625	0287	0335
	0193	0109	0560	0037
	0556	0035	0343	0653
	0108	0361	0548	0443
	1037			
Fidelity	0163	0512	0363	0037
	0556	0371	0412	0193
	0216	0264	1908	0361
Finlandia	0208	0346	0548	0361
	0163	0363	0287	0343
Finlux	0105	0037	0556	0714
	0346	0163	0516	0715
	0070	0411	0631	0492
	0480	1556	0473	0418
	0606	0808		
Firstline	0037	0556	0374	0668
	0714	0163	0009	0216
	0247	1909	0411	0208
	0361	1037	1191	0808
	1363	1163		
Fisher	0036	0208	0370	0361
	0163			
Flint	0037	0556	0610	0218

	0455	0264		
Force	1149			
Forgestone	0193			
Formenti	0163	0037	0556	0486
	0216			
Formenti-Phoenix	0216			
Fortress	0093			
Fraba	0037	0556	0370	
Friac	0009	0037	0556	0370
	0499	0610		
Frontech	0247	0264	0363	0009
	0163			
Fujimaro	0865			
Fujitsu	0163	0009	0352	0037
	0556	0361	0853	
FujitsuGeneral	0009	0163		
FujitsuSiemens	1298	1259	1163	
Funai	0668	0264	0412	
Furichi	0860			
Futronic	0264	0795	0860	
Future	0037	0556		
Galaxi	0037	0556	0361	0163
Galaxis	0370	0418	0037	0556
Galeria	0009			
GBC	0163	0009	0374	0218
	0363			
GE	0343	0178	0282	0560
	0287	0109	0335	0625
GeantCasino	0163			
GEC	0163	0361	0037	0516
	0556			
Geloso	0247	0009	0363	0163
	0374			
General	0109	0287		
GeneralElectric	0343	0287		
GeneralTechnic	0009			

Genesis	0009	0037	0556	
Genexxa	0218	0037	0556	0412
	0163	0009		
Gericom	0865	1298	1217	0880
Goldfunk	0668			
Goldhand	0216			
GoldStar	0037	0009	0370	0001
	0377	0178	0247	0216
	0556	0163	0361	0109
	0363	0606	0714	0715
	0455			
Gooding	0487			
Goodmans	0634	1259	1037	0037
	0499	0556	0714	0668
	1909	0374	0036	0264
	0516	0009	0487	0371
	0343	0035	0480	0560
	0335	0218	1908	0661
	1900	0880	1308	0587
	1376			
Gorenje	0370			
GPM	0218			
Gradiente	0653	0170	0037	0556
Graetz	0714	0361	0371	0163
	0037	0339	0556	1163
GranPrix	0648			
Granada	0037	0556	0226	0108
	0208	0036	0339	0516
	0473	0335	0560	0163
	0363	0225	0343	0548
Grandin	0037	0556	0009	0163
	0610	0714	0715	0668
	0374	0282	0218	0455
	1037	0865	1191	0880
Gronic	0163			
Grundig	0195	0508	0535	0191

	0070	0487	0037	0443
	0706	0556	0587	0009
	0036	0370	1935	1908
	1308	0178	1376	0343
Grunkel	1163			
H&B	0808			
Haaz	0706			
Haier	0698	0264		
Halifax	0264	0216		
Hammerstein	0264			
Hampton	0216			
Hanimex	0218	1908		
Hanseatic	0037	0556	0499	0519
	0163	0361	0282	0394
	0634	0370	0661	0009
	0377	0714	0808	0486
Hantarex	0009	0037	0556	0516
Hantor	0037	0556		
Harsper	0865			
Harwa	0773	1196	1269	
Harwood	0009	0412	0037	0556
	0487			
Hauppauge	0037	0556		
HCM	0009	0412	0037	0556
	0218	0418	0282	0264
Hedzon	0556	0037		
Hema	0009			
Hicon	1467			
Hifivox	0109			
Higashi	0216			
Highline	0264	0037	0556	
Hikona	0218			
Hinari	0208	0037	0556	0009
	0218	0036	0163	0355
	0443	0487	0264	1908
Hisawa	0282	0218	0455	0610

	1908	0714		
HISense	1363	0208		
Hitachi	0225	1225	0578	0036
	0108	0473	0163	0343
	0516	0481	0499	0037
	0556	0109	0363	0548
	0719	0634	0744	0178
	1137	0105	0492	1481
	0361	0512	0480	1037
	1576	1149		
HitachiFujian	0108	0225		
Hitsu	0009	0610	0455	0218
HMV	0193			
Hoher	0714	1556	0865	
HomeElectronics	0606			
Hornophon	0037	0556		
Hoshai	0218	0455	0282	
Huanyu	0374	0216		
Hugoson	0890	1217		
Hygashi	0216			
Hyper	0009	0216	0247	
Hypersonic	0361			
Hypson	0037	0556	0714	0715
	0264	0282	0455	1908
	1037	0668	0486	
Hyundai	0037	0865	0556	0706
	0860	0753	1598	1556
Iberia	0037	0556		
ICE	0264	0037	0371	0009
	0556	0218	0216	
Ices	0218	0216		
Ict	0037	1137	0556	
IISonic	1376			
Iiyama	1217	0890		
Imperial	0037	0163	0370	0074
	0084	0556	0411	0361

	0418	0247		
Indiana	0037	0556		
InFocus	1164			
Ingelen	0487	0610	0714	0163
	0361			
Ingersoll	0009			
InnoHit	0009	0037	0556	0218
	0516	0247	0282	1163
Innovation	0519	0037	0556	
Innowert	0865	1298		
inotech	0773	0820		
Interactive	0037	0556	0512	0327
	0163	0361	0370	0109
	0411			
Interbuy	0009	0037	0264	0247
	0512	0556		
Interfunk	0037	0556	0512	0327
	0163	0361	0370	0109
	0247	0200		
Internal	0037	0556	0499	0374
	1909			
International	0216			
Intervision	0282	0455	0037	0371
	0377	0519	0486	0370
	0394	0487	0218	0163
	0264	0247	0009	0556
Irradio	0009	0037	0556	0218
	0247	0371		
Isukai	0218	0037	0556	0282
	0455			
ITS	0037	0371	0218	0282
	0264	0216	0009	0556
ITT	0163	0480	0361	0473
	0548	0193	0346	0339
	0208	0610		
ITT Nokia	0361	0548	0163	0473

	0480	0346	0208	0339
	0606	0610	0631	0363
ITV	0264	0037	0556	0247
	0374			
JDV	1982			
Jean	0036			
JEC	0035			
JMB	0037	0499	0634	0374
	0556	0443	1908	
Jocel	0712			
Jubilee	0556			
JVC	0653	0036	0193	0371
	0218	0606	0418	0093
	0650			
Kaisui	0218	0282	0037	0556
	0216	0455	0009	
Kambrook	0377			
Kamp	0216			
Kapsch	0163	0361		
Karcher	0037	0556	0370	0610
	0163	0282	0264	0778
	0714	1556	0606	
Kathrein	0556	0037		
Kawa	0371			
Kawasho	0216			
KBAristocrat	0163			
Kendo	0610	0037	0556	0163
	0519	0512	0370	0377
	0363	0411	0247	0362
	0648	1037	1437	0486
Kennedy	0163	0435		
Kennex	1037			
Kenwood	0105			
Kingsley	0216			
Kiota	0001			
Kiton	0556	0037	0668	

Kneissel	0037	0370	0610	0411
	0374	0499	0556	0435
	0362	1908		
Kobra	1467			
Kolster	0037	0556	0247	0218
Konichi	0009			
Konka	0037	0556	0371	0714
	0418	0218	0641	0587
	0754	0894		
Kontakt	0487			
Korpel	0037	0556		
Korting	0370			
Kosmos	0037	0556		
Kotron	0412	0264		
Koyoda	0009			
Kuba	0163			
KubaElectronic	0163			
Kyoshu	0412	0418	0264	
Kyoto	0163	0216		
L&SElectronic	0865	0714		
LaSAT	0486	0370		
Lavis	1037	0037	0163	
Leader	0009			
Lecson	0037	0556		
Legend	0009			
Lemair	0411			
Lenco	0037	0009	0163	0374
	0556	0587	1037	
Lenoir	0009			
Lesa	0247			
LevisAustria	0037	0556		
Lexsor	1196			
Leyco	0264	0037	0556	
LG	0037	0178	0370	0009
	0377	1265	0001	0556
	0714	0216	0163	0606

	0109	0698	0715	1637
	1191	1423	1305	0247
	0361			
Liesenk&Tter	0327	0037	0556	
Liesenkotter	0037	0327	0328	0556
Lifetec	0037	0009	0519	0374
	0668	0512	1037	1137
	0556	0218	0264	1248
	0714			
Lloyd's	0001	0009		
Lodos	1037	1149		
Loewe	0512	0633	0790	0037
	0556	0370	0362	0516
Logik	0011	0698	0773	0009
	0193	0264	0371	0001
	0880	1217	1037	
Logix	0668	0519		
Luker	1982			
Luma	0037	0363	0163	0411
	0556	0374	0009	0362
Lumatron	0363	0037	0556	0362
	0163	0361	0264	0073
LuxMay	0037	0009	0556	
Luxor	1163	0363	0480	0492
	0361	0208	0548	0163
	0346	0473	1037	0631
LXI	0178			
Madison	0037	0556		
Magnadyne	0247	0516	0163	
Magnafon	0516	0216	0073	
Magnavox	0037	0556	0036	0780
Magnum	0648	0714	0037	0556
	0715	1289		
Mandor	0264			
Manesth	0037	0556	0264	0035
	0163	0363		

Manhattan	0037	0556	0668	1037
	1267	0163	0778	
Marantz	0037	0556	0412	
Mark	0037	0556	0216	0374
	0009	0714	0715	
Master's	0499	0037		
Masuda	0218	0371	0009	0264
	0037	0556		
Matsui	0037	0556	0487	0009
	0011	0355	0036	0371
	0433	0443	0363	0455
	0163	0516	0035	0208
	0195	0191	0335	0714
	1908	1037		
Matsushita	0650			
Matsuiama	0587			
Maxam	0264			
Maxdorf	0773			
Maxim	1982	1556		
MCE	0009			
Mediator	0037	0556		
Medion	0037	0714	0808	0519
	0668	0556	0512	1137
	0698	1908	1037	1437
	1900	1248	0880	1289
Megas	0610			
Megatron	0178			
MEI	1037	0037	0556	
Melectronic	0346	0037	0512	0109
	0343	0247	0105	0374
	0009	0480	0492	0216
	0411	0163	0287	0556
	0634	0361	0191	0195
	0661	0714		
Memorex	0009	0178	0650	
Memphis	0009			

Mercury	0001	0037	0009	0556
Merritt	0548	0361	0163	
Metz	0388	0447	0746	0367
	1163	0195	0535	0191
	0037	0556	0587	0668
	1037	1533		
MGA	0178	0037	0556	0218
Micromaxx	0037	0556	0668	1037
	0808			
Microstar	0808			
MicroTEK	0820			
Mikomi	1149			
Minato	0037	0556		
Minerva	0487	0535	0195	0070
	0191	0516	0108	
Minoka	0412	0037	0556	
Mirror	1900			
MistralElectronics	0193			
Mitsubishi	0108	0093	0512	0037
	0178	0036	0193	0535
	0556	0208	1037	
MitsuriGeneral	0163			
Mivar	0370	0216	0609	0516
Monaco	0009			
Morgan's	0037	0556		
Motorola	0093			
MTC	0370	0512	0163	0216
	0361			
MTlogic	0714	1308		
Multibroadcast	0193			
Multitec	0037	0556	0486	0668
	1037	1556		
Multitech	0009	0363	0486	0037
	0370	0556	0216	0247
	0264			
Murphy	0216	0163		

Musikland	0037	0218	0247	0556
MyCom	1376	0178		
Myryad	0556	0037		
NAD	0178	0361	0163	
Naiko	0037	1982	0606	0556
Nakimura	0374	0037	0556	
Naonis	0363	0163		
Narita	1982			
NAT	0226			
National	0226			
NEC	0170	0587	1170	1270
	0036	0455	0009	0374
	0037	0556	0011	1704
	0499	0653	0661	
Neckermann	0037	0191	0370	1505
	0200	0556	0163	0327
	0418	0247	0411	0363
	0512			
NEI	0037	0556	0371	0163
Neovia	0865	1376		
Nesco	0247	1908		
Netsat	0037	0556		
Neufunk	0037	0009	0556	0610
	0218	0282	0714	
NewTech	0037	0009	0556	0343
NewWorld	0218			
Nicamagic	0216			
Nikkai	0218	0037	0556	0264
	0035	0216	0009	0036
Nikkei	0714			
Nikko	0178			
Noblisko	0070	0216		
Nogamatic	0109			
Nokia	0361	0163	0480	0548
	0492	0473	0339	0208
	0374	0631	0606	0346

	0610	0109		
Nordmende	0109	0714	0891	0287
	0560	0343	0195	0037
	0556	0335	0163	1259
Norfolk	0163			
Normerel	0037	0556		
Novak	0037	0556		
Novatronic	0037	0105	0374	0556
NU-TEC	0455	0698		
Nurnberg	0163	0361		
Oceanic	0163	0361	0208	0473
	0548	0480		
Odeon	0264			
Okano	0370	0037	0556	0264
	0009			
Olidata	1376			
Omega	0264			
Omni	0780	0891	0698	
Onwa	0371	0602	0218	0433
Opera	0037	0556		
Optimus	0650			
Optonica	0093			
Orbit	0037	0556		
ORcom	1504			
Orion	0037	0443	0355	0556
	0714	0011	0009	0264
	0412	0516	1908	0880
	1196			
Orline	0037	0218	0556	
Ormond	0668	1037	0037	0556
Orsowe	0516			
Osaki	0218	0264	0037	0412
	0374	0355	0556	
Osio	0037	0556		
Oso	0218			
Osume	0036	0218	0037	0556

OttoVersand	1505	0036	0093	0512
	0037	0556	0535	0195
	0191	0361	0109	0226
	0247	0009	0282	0343
	0516	0519		
Pace	1908			
Pacific	0037	0556	1137	0714
	1037	0443		
Pael	0216			
Palladium	0370	0037	0411	0714
	1137	0191	1505	0200
	0418	0556	0247	0327
	0163	0519	0363	
Palsonic	0264	0412	0037	0377
	0218	0698	0556	0773
	0001	0418	0778	1196
Panama	0009	0264	0216	0037
	0556	0247		
Panashiba	0001			
Panasonic	0650	0108	0226	0361
	0367	0516	0037	0556
	0163	0548	1310	0001
	0853	0178		
Panavision	0037	0411	0556	
Papouw	0037	0556		
PatheCinema	0163	0216	0370	
PatheMarconi	0109			
Pausa	0009			
Perdio	0163	0037	0216	0282
	0556			
Perfekt	0037	0556		
Philco	0084	0074	0418	0247
	0163	0370	0037	0556
	0519			
Philex	0193	0163		
Philips	0556	0037	0191	0193

	0343	0374	0361	0009
	0200	1756		
Phocus	1289	1308	0714	
Phoenix	0037	0556	0370	0486
	0163	0216		
Phonola	0037	0556	0193	0216
Pilot	0556	0037	0712	0706
Pioneer	0760	0011	0037	0170
	0556	1260	0370	0343
	0361	0109	0163	0287
	0486	0512		
Pionier	0370	0486		
Plantron	0037	0556	0264	0009
Playsonic	0714	0037	0339	0715
Policom	0109	0361	0163	0070
	0074	0084	0535	
Polytron	0282			
Poppy	0009			
Portland	0374	1909		
Powerpoint	0487	0037	0556	0698
Prandoni-Prince	0247	0516	0361	0363
Premier	0009	0264		
President	0860			
Prima	0009	0264	0412	1269
Princess	0698			
Prinston	1037			
Prinz	0361			
Profex	0009	0163	0361	0363
Profi	0009			
Profitronic	0037	0556		
Proline	0037	0556	0625	0634
	0411	1376		
Prosonic	0037	0556	0370	0374
	0371	0668	0714	0216
Protech	0037	0556	0009	0247
	0264	0418	0668	0282

	0163	0486	1037	
Proton	0178			
Provision	0499	0037	0556	1037
	0714			
PVision	1191			
Pye	0037	0556	0374	0412
Pymi	0009			
Quadral	0218			
Quasar	0247	0650	0865	0009
Quelle	0037	1505	0011	0109
	0512	0535	0191	0361
	0036	0247	0074	0327
	0084	0328	0070	0105
	0668	0556	0195	0200
	0264	1037	0346	0009
Questa	0036			
R-Line	0037	0556	0163	
Radialva	0109	0218	0163	0037
	0556	0287		
Radiola	0037	0556		
Radiomarelli	0516	0247	0037	0556
RadioShack	0037	0556	0178	
Radiotone	0009	0037	0556	0370
	0418	0412	0648	0668
	0264	1037		
Rank	0070			
RankArena	0036	0602	0753	
RBM	0070			
RCA	0625	0093	0560	0335
	0343	0753		
Realistic	0178			
Recor	0037	0418	0556	
Rectiligne	0037	0556		
Rediffusion	0361	0548	0036	0346
Redstar	0037	0556		
Reflex	0037	0556	1037	0668

7 Appendix

Relisys	0865	0877	1207	1298
Reoc	0714	0634	1909	
Revox	0037	0556	0370	
Rex	0363	0411	0247	0163
	0264			
RFT	0370	0264	0037	0556
	0486			
Rhapsody	0216			
Ricoh	0037	0556		
Rinex	0773	0418		
Roadstar	1037	0009	0418	0037
	0556	0714	0668	0218
	0264	0282	1189	1900
Rodex	0037	0556		
Rover	0036	0877		
Rowa	0264	0698	0712	0009
	0216	0587	0037	0556
Royallux	0370	0412	0335	
Rukopir	0556	0037		
Saba	0625	0109	0560	0343
	0287	0163	0516	0361
	0498	0335	0548	0650
	0714			
Sagem	0610	0455	0282	0830
	0618			
Saisho	0516	0009	0011	0163
	0264			
Saivod	0037	1982	0556	1163
	0668	0712	1037	
Saka?	0163			
Sakyno	0455			
Salora	0163	0361	0516	0363
	0548	0339	0208	0480
Salsa	0335			
Sambers	0516			
Samsung	0618	0587	0037	0178

	0556	1249	0093	1235
	0009	0370	0264	0216
	0208	0519	0163	0625
Sandra	0216			
Sansui	0037	0729	0556	0706
	0371	0602	0455	0861
	0753			
Santon	0009			
Sanyo	0208	1208	0036	0011
	0370	0339	0216	0009
	0163	0037	0108	0556
	0486	0170		
Save	0037	0556		
Saville	1908			
SBR	0037	0556	0193	
SchaubLorenz	0548	0714	0361	0606
	0486	0374	1191	
Schneider	1137	0037	0556	0519
	0394	0352	0343	0247
	0371	0361	0218	0668
	1037	0163	0648	0714
	1909	1908	1982	0070
Scotland	0163			
Scott	1189	0178		
Sears	0178			
Seaway	0634			
Seelver	0556	1037	0037	
SEG	0037	0556	1037	1437
	0668	0487	0009	0163
	0264	0634	0036	0247
	0362	0216	1163	0218
	1909	1901	0714	
SEI	1505	0163	0516	0037
	0556			
Sei-Sinudyne	0516	1505	0037	0556
Seitech	1217			

Seleco	0363	0362	0163	0411
	0371	0036	0264	0346
	0435			
Sencora	0009			
Sentra	0035	0218	0009	
Serino	0610	0455	0216	0093
Sharp	0093	1193	0036	0653
	0193	0516	0200	0760
	1393	1163		
Shintoshi	0037	0556		
Shivaki	0037	0556	0443	0374
	0178			
Show	0418	0009		
Siarem	0163	0516		
Siemens	0191	0535	0200	0195
	0327	0328	0037	0556
	0361			
Siera	0037	0556	0587	
Siesta	0370			
Silva	0037	0556	0216	0361
	0648			
SilvaSchneider	1556			
Silver	0036	0037	0455	0361
	0556	0715	0163	
SilverCrest	1037	0037	0556	
Singer	0009	1537	0037	0556
	0247	0435	0335	0163
Sinotec	0773			
Sinudyne	0163	0361	0516	1505
	0037	0556	1908	
Sky	0037	0282	0880	0178
	0556	1504		
Skymaster	0105			
Skysonic	0753			
Sliding	0865	0880		
SLX	0668			

Smaragd	0487			
Soemtron	0865	1298		
Solavox	0361	0163	0548	0037
	0556			
Sonawa	0218			
Soniko	0037	0556		
Soniq	1467			
Sonitron	0208	0370	0339	
Sonneclair	0037	0556		
Sonoko	0037	0556	0009	0264
	0282			
Sonolor	0208	0163	1505	0548
	0361	0282		
Sontec	0037	0556	0370	0009
Sony	1505	1651	0011	1751
	0353	0036	0037	0556
	0093	0170	0074	
Sound&Vision	0218	0374	0037	0556
Soundesign	0178			
Soundwave	0037	0556	0418	0715
Soyea	0773			
Spectra	0009			
Ssangyong	0009			
Staksonic	0009			
Standard	0037	0556	1037	0218
	0009	0374		
Starlite	0009	0163	0037	0556
	0264	0412		
Stenway	0282	0218		
Stern	0163	0363	0264	0411
	0435			
Stevison	1982	1556		
Strato	0037	0556	0264	0009
Strong	1163	1149	1037	0037
	0556			
SunicLine	0037	0556		

Sunkai	0355	0455	0218	0610
	0037	0556	0487	0865
Sunstar	0371	0037	0556	0009
	0264			
Sunwatt	0455			
Sunwood	0037	0556	0009	
Superla	0516	0216		
Supersonic	0208	0556	0698	0264
	0805	0455		
SuperTech	0009	0037	0556	0216
	0218			
Supra	0178	0374	0009	
Susumu	0335	0218	0287	
Sutron	0009			
Svasa	0805			
Swissline	0247			
Swisstec	1504	0880		
Sydney	0216			
Sysline	0037	0556		
Sytong	0216			
T+A	0447			
Tandberg	0367	0411	0109	0362
	0361	0163		
Tandy	0218	0247	0093	0163
Tashiko	0036	0170	0216	0163
	0363			
Tatung	1556	0037	0556	0516
	0011	1908	1756	1259
	1191			
TCM	0714	1289	0808	
Teac	0698	0512	0037	1437
	1037	0556	0712	0668
	0455	0706	0264	1909
	0178	0009	0412	0282
	0418	0170	0714	1149
	1755			

TEC	0009	0247	0335	0037
	0556	0361	0163	
TechLine	0037	0556	0668	1437
	1163			
TechLux	1189			
Techica	0218			
Technica	1982			
Technics	0650			
TechniSat	0037	0556	0163	1267
Technisson	0714	1289		
Technosonic	0037	0556		
Techwood	1163			
Tecnimagen	0556			
Tedelex	0418	0606	1537	0009
	0706	0208	0698	0587
	0891	0037	0556	
Teiron	0009			
Teleavia	0109	0287	0343	
Telecor	0037	0556	0163	0218
	0394			
Telefunken	0625	0560	0074	0587
	0109	0698	0343	0712
	0498	0820	0896	0754
	1504	0287	0084	0335
	0073	0037	0556	0486
	0714	1556	0346	0821
Telefusion	0037	0556		
Telegazi	0037	0163	0218	0264
	0556			
Telemeister	0037	0556		
Telesonic	0037	0556		
Telestar	0009	0037	0556	0412
Teletech	0037	0556	0668	0009
	0247	1037		
Teleton	0163	0036	0363	
Televideon	0163	0216		

Televue	0037	0556		
Tempest	0009	0037	0556	0264
Tennessee	0037	0556		
Tensai	0218	0037	0556	0009
	0105	0374	0371	0377
	0247	0715	0163	1037
Tenson	0009			
Tesla	0037			
Tevion	0519	0894	1259	1298
	0037	1556	0556	0808
	0648	0668	1137	0714
	1037	1248	1289	
Texet	0374	0009	0216	0218
Thomson	0625	0560	0343	0287
	0109	0335	0037	0556
	0216			
Thorn	0108	0193	0109	0073
	0225	0343	0361	1505
	0074	0084	0499	0535
	0037	0556	0011	0335
	0512	0036	0374	0035
	0070			
Thorn-Ferguson	0108	0109	0193	0361
	0335	0499	0073	0035
Tiny	1196	1269		
TMK	0178			
Tobishi	0218			
Tokai	0037	0556	0668	0163
	0374	0009	1037	
Tokaido	1037			
Tokyo	0216	0035		
Tomashi	0282	0218		
Tongtel	0780	0587		
Topline	1037	0668		
Toshiba	0508	1508	0035	1289
	0036	0070	0714	0109

	0718	0195	0191	0618
	1908	0009	0698	0037
	1164	1163	1935	1556
	1265	0650	1704	
Toyoda	0009	0371	0264	
Trakton	0009	0264		
TransContinens	0668	1037	0037	0556
	0486			
TRANScontinents	0865			
Trasonic	0037	0556	0455	0587
	0512	0264	0698	0712
	0418	0009		
Transtec	0216			
Triad	0037	0556	0218	
Trident	0516			
Tristar	0264	0218	0193	
Triumph	0516	0346	0556	0037
Tsoschi	0282			
TVTEXT95	0556			
Uher	0037	0556	0374	0418
	0486	0370	0480	
Ultravox	0374	0247	0216	0163
	0037	0556		
UnicLine	0037	0556	0473	0455
United	0714	0037	0715	0556
	1908	1037	0587	1982
Universal	0037	0556		
Universum	0346	0105	0195	0473
	0535	0361	0247	0492
	0480	0370	0200	0418
	0011	0037	0512	0036
	0070	0163	0264	0556
	0411	0074	0327	0328
	1505	0668	0109	0362
	0631	0009	0084	1901
	1037	1437	0170	1163

	1149	0618		
Univox	0037	0556	0163	
Utax	0163			
V7Videoseven	1755	0178	0880	1376
	1217			
Vestel	0037	0163	0556	0668
	1037	1163		
Vexa	0009	0037	0556	
Victor	0653			
Videologic	0218	0216		
Videologique	0216	0218		
Videosat	0247			
VideoSystem	0037	0556		
Videotechnic	0216	0374		
Videoton	0163			
Vidtech	0036	0178		
ViewSonic	1755			
Visiola	0216			
Vision	0037	0264	0556	
Vistar	0361			
Vortec	0037	0556		
Voxson	0037	0556	0363	0418
	0163	0178		
Waltham	0418	0287	0037	0556
	0668	0109	1037	0163
	0443			
Watson	1037	1248	0037	0556
	0163	0009	0668	0218
	0519	0394	1908	1437
	1376	0327		
WattRadio	0163	0216		
Wega	0037	0556	0036	
Wegavox	0009	0037	0556	
Welltech	0714			
Weltblick	0037	0556		
Weston	0037	0556		

Wharfedale	0037	0861	0519	0896
	0556	1556		
WhiteWestinghouse	0216	0037	0556	1909
Windsor	0668	1037		
Windstar	0282			
WindySam	0556			
Wintel	0714			
World-of-Vision	0880	0890	0865	1289
	1298	0877	1217	
Worldview	0455			
X-View	1191			
Xenius	0634			
XLogic	0698	0860		
Xoro	1196	1217		
Xrypton	0037	0556		
Yamaha	0650	1576		
Yamishi	0282	0455	0218	0037
	0556			
Yokan	0037	0556		
Yoko	0037	0556	0218	0264
	0009	0370	0339	0216
	0247			
Yorx	0218			
Zanussi	0363			
Zenith	1909			
Zenor	0339			
ZX	1908			