

## Growatt CP630TL

### PV Grid-Connected Inverter Installation Manual



Thank you for choosing the Growatt CP630TL. Growatt CP630TL PV grid-connected inverter products have high efficiency, wide MPPT voltage range, advanced DSP control technology, perfect protection function enables PV systems more reliable operation, simple to operate, easy to maintain. We believe that the product will be more widely used in a variety of industrial, commercial and residential areas.

## Content

1 About this Manual .....	4
1.1 Contents .....	4
1.2 Target readers .....	4
1.3 How to use this Manual .....	5
1.4 Symbols explanation .....	5
2 Safety instructions.....	6
2.1 Installation.....	7
2.2 Operator .....	7
2.3 Inspection and storage.....	7
2.4 Transportation .....	8
2.5 Installation.....	8
2.6 Repair and maintenance .....	9
2.7 Inverter EMC and noise level .....	10
2.8 Important note .....	10
3 Product description .....	11
3.1 Grid-connected PV system.....	11
3.2 Circuit diagram the inverter .....	11
3.3 The layout of the main components .....	12
3.3.1 External components.....	12
3.4 Operation mode.....	16
3.4.1 Standby mode.....	16
3.4.2 Grid mode .....	16
3.4.3 Faulty mode.....	17
3.4.4 Permanent faulty mode .....	17
3.5 Protection .....	18
3.6 Storage .....	18
3.7 Dimension .....	19
3.8 Label.....	19
3.9 Packaging information .....	20
4 Products installation.....	21
4.1 Installation condition requirements.....	21
4.2 Tools and spare parts required for whole machine installation .....	23
4.3 Mechanical installation .....	24
4.3.1 Transportation of packaged whole machine.....	24
4.3.2 Movement and installation of bare machine .....	25
4.4 Electrical installation.....	28
4.4.1 Input and output requirements.....	28
4.4.2 Preparation for electrical wiring.....	29
4.4.3 DC side wiring .....	31
4.4.4 AC side wiring.....	32
4.4.5 Earthing .....	34
4.5 Communication .....	35

4.5.1 RS485 communication .....	35
4.5.2 Internet communication.....	35
4.6 Installation inspection .....	36
5 Pilot operation .....	36
5.1 Relevant requirements.....	37
5.2 Inspection .....	37
5.2.1 Inverter inspection.....	37
5.2.2 Grid voltage inspection .....	37
5.2.3 DC side voltage inspection.....	38
5.3 Power on steps.....	38
5.4 Pilot operation completion .....	39
5.5 Power off steps .....	39
6 GUI instruction .....	40
6.1 LCD display screen introduction.....	40
6.2 LCD operation.....	41
6.2.1 Initialization .....	41
6.2.2 Home page .....	41
6.2.3 ON/OFF interface.....	42
6.2.4 System setting .....	43
6.2.5 Historical information .....	45
6.2.6 Operation data .....	47
6.3 LCD display information schedule .....	50
6.3.1 General history failure table.....	50
6.3.2 Serious fault history .....	53
6.3.3 Inverter status .....	54
7 Routine maintenance.....	54
7.1 Replacing the dust screen.....	54
7.2 Regular maintenance .....	55
7.3 Waste disposal .....	56
8 Appendix .....	57
8.1 Specification.....	57
8.2 software version .....	58
8.3 Growatt Factory warranty .....	58
8.4 Contact .....	59
Importer: .....	59

# 1 About this Manual

This chapter describes the contents of this manual, target reader, and safety symbols, can help users to have a better understanding of the manual.

## 1.1 Contents

This manual applies to Growatt CP630TL PV grid-connected inverters, the manual contains:

✧ safety instruction

Attention that needs to be paid when operating and maintaining the Growatt CP630TL.

✧ Product description

The role inverter plays in the photovoltaic grid-connection system and structure, principle, protection, operation mode, storage and package size of the Growatt CP630TL.

✧ Installation

Inverter installation conditions, tools, and the inverter mechanical and electrical installation, the communication connection and inspection.

✧ Commissioning

Inspection before commissioning and procedure to turn on/off inverter.

✧ GUI(Graphic User Interface) instruction

Information displayed on the inverter LCD touch-screen and setting instruction.

✧ Routine maintenance

Daily maintenance of the inverter, the replacement of some spare parts and waste disposal instruction.

✧ Appendix

Technical data, warranty policy and contact information.

## 1.2 Target readers

Qualification

1) Only professional electricians or professionally qualified personnel can transport or install this

product.

- 2) The operator should be fully familiar with the structure and working principle of the entire grid-connected PV system;
- 3) The operator should be fully familiar with this manual;
- 4) The operator should be fully familiar with the local standards of the project.



## 1.3 How to use this Manual



Read this manual before installation of the Growatt CP630TL. Store this manual where accessible at all times.

The contents of this manual will be periodically updated or revised if necessary. However discrepancies cannot be excluded. Please refer to the product or download the latest version of this manual on [www.growatt.com](http://www.growatt.com).

## 1.4 Symbols explanation

In order to ensure the personal and property safety of the user during installation, or optimally efficient use of this product, symbols are used highlight the information. The following symbols may be used in this manual, please read carefully, in order to make better use of this manual.

	<b>Caution, risk of danger</b>
<b>DANGER</b>	
DANGER indicates a hazard with a high level of risk which, if not avoided, will result in death or serious injury.	
	
<b>CAUTION</b>	
CAUTION indicates there is potential risk, if not avoided, could result in equipment malfunction and property damage.	

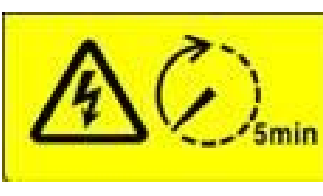
	<p><b>Caution, risk of electric shock</b></p>
<p>WARNING</p> <p>When PV array exposed to sunlight, there will be DC voltage in the equipment DC side; and when output breaker is on, there is a potential risk of electric shock.</p>	
	<p><b>Caution, risk of fire hazard</b></p>
<p>WARNING</p> <p>Suitable for mounting on concrete or other non-combustible surface only.</p>	
	<p><b>Protective conductor terminal</b></p>
<p>PE TERMINAL</p> <p>The inverter has to be firmly grounded to ensure the safety of personnel.</p>	
	<p><b>Risk of electric shock, Energy storage timed discharge.</b></p>
<p>WARNING</p> <p>Electrical shock danger exists in the capacitor; the cover shall be moved at least 5 minutes later after all powers are disconnected.</p>	

## 2 Safety instructions

Inverter installation and service personnel must be trained and familiar with the general safety requirement when working on electrical equipment. Installation and service personnel should also

be familiar with the local laws and regulations and safety requirements.

- ✧ Read this manual carefully before operation. The equipment will not be under warranty if failing to operate according to this manual.
- ✧ Operation on the inverter must be for qualified electrical technician only.
- ✧ When inverter operating, don't touch any electrical parts except for the touch-screen.
- ✧ All electrical operation must comply with local electrical operation standards.
- ✧ Warranty service for the inverter does not contain module maintenance.
- ✧ Permission from the local utility company is required before installing the PV Grid-connected system and only professional personnel are qualified for the operation.

## **2.1 Installation**

Proper installation requires following all the instructions in the user manual involving transportation, mounting, wiring and commissioning. Growatt does not cover warranty for the inverter damage due to failing to use it properly.

## **2.2 Operator**

Inverter installation and service personnel must be trained and familiar with the general safety requirement when working on electrical equipment. Installation and service personnel should also be familiar with the local laws and regulations and safety requirements.

## **2.3 Inspection and storage**

The inverter should be carefully checked before signing the document from the transportation company. Check the received items against delivery note, and if there is any defect or damage, immediately notify the transportation company. If necessary, you can seek help from Growatt Customer Service department.

**CAUTION**

The Growatt CP630TL can only be stored when it is stopped and all the doors are closed in a dry room to protect the internal circuits against dust and moisture.

## 2.4 Transportation

Transportation should follow the transportation methods described in the user manual. The inverter's weight and center of gravity of the non-centered should be taken into account during transportation. The center of gravity has been marked on the box.

**Caution, risk of danger****DANGER**

During transportation, lifting equipment and personnel must be qualified. The inverter should be placed vertically and the inclination cannot be more than 10 degrees. It is not allowed to place the inverter upside down or transport in a horizontal position. Incorrect lifting and transportation can lead to serious injury, property loss and damage to the inverter.

## 2.5 Installation

The protection level of the inverter is IP20, which is designed for indoor installation. Please refer to chapter 4 for installation instruction.

The installation location must be dry, including no expected condensation. The inverter is only for use in a closed electrical operating area. When the photovoltaic array is exposed to light, it supplies a D.C. voltage to the PCE.





**Caution, risk of fire hazard**

**WARNING**

Suitable for mounting on concrete or other non-combustible surface only.

## 2.6 Repair and maintenance

Repair and maintenance can only be carried out after disconnecting the DC and AC wiring for at least 5 minutes.

Only professional technical personnel are qualified for the operation.

Disconnecting switches

Disconnect DC switch and AC switch, and make sure the inverter will not be connected accidentally. Ensure the inverter is totally disconnected with no voltage by testing with a multi-meter. Although the DC and AC switch has been disconnected, there is still voltage in some components, for example capacitors. Hence, the repair or maintenance operation can only be proceeded at least 5 minutes after the disconnection.

✧ Maintenance and modification

Only personnel with Growatt authorization are qualified for the maintenance and modification.

And to ensure personal safety, use original accessories provided by the manufacturer only.

Otherwise, electrical safety and EMC might not comply with the required standard.

✧ Function and safety parameters

Don't change the parameters of the inverter without authorization from the local utility and Growatt New Energy Co., Ltd. Otherwise, it might lead to injury or equipment damage and the warranty of the inverter will be voided.



**Risk of electric shock, Energy storage timed discharge.**

**WARNING**

Electrical shock danger exists in the capacitor; the cover shall be moved at least 5 minutes later after all powers are disconnected.

## 2.7 Inverter EMC and noise level

Electromagnetic compatibility (EMC) is the requirement for electrical equipment that it can operate normally in the electromagnetic environment and does not cause unacceptable environmental impact itself.

- ✧ Anti-interference property from internal components.
- ✧ Anti-interference property from outside.
- ✧ Electromagnetic emission impact on the environment

Inverter may generate some noise and electromagnetic radiation during operation. According to EMC emission and noise level, inverter should be used in industrial environments. Hence, all personnel should not stay long near the inverter.

## 2.8 Important note

**Item 1: Static electricity can cause damage to the inverter**

- Electrostatic discharge may cause unrecoverable damage to inverter internal components!
- When operating the inverter, operator must comply with anti-static protection norms!

**Item 2: Restriction**

The inverter cannot be directly used to connect the life support equipment and medical equipment!

**Item 3: Precautions**

Make sure installation tools or other unnecessary items are not left inside the inverter before starting up.

**Item 4: Maintenance notice**

Maintenance can only be carried out after the inverter totally discharged.

## 3 Product description

### 3.1 Grid-connected PV system

Growatt CP series inverters are grid-connected central inverters which convert DC current generated by PV modules into AC current and feed it into the public grid. PV inverters always act as key components.

Grid-connected PV system shown as below

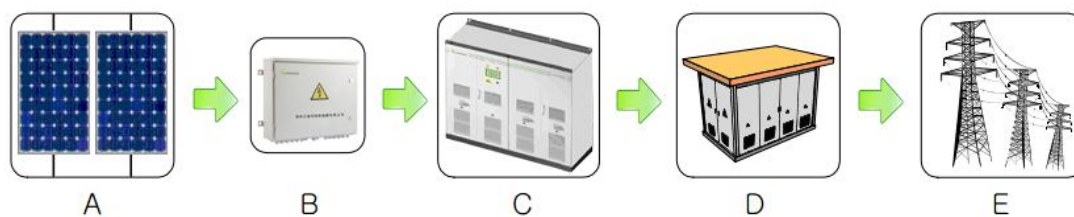

Figure 3 - 1 Grid-connected PV system

No.	Name
A	PV module
B	PV combiner box
C	Inverter
D	transformer
E	utility grid

### 3.2 Circuit diagram the inverter

Growatt CP630TL PV grid-connected inverter converts DC current generated by PV array into AC current. Then the AC current is filtered into sine wave electricity and fed into the utility grid through a medium-voltage isolating transformer. The additional external isolating transformer shall be connected between inverter and local power grid by customers. This transformer shall be met requirement of local grid and tests about external isolating transformer must be passed successfully according to relevant safety standards! (clearance distance, creepage distance, dielectric strength test etc. )

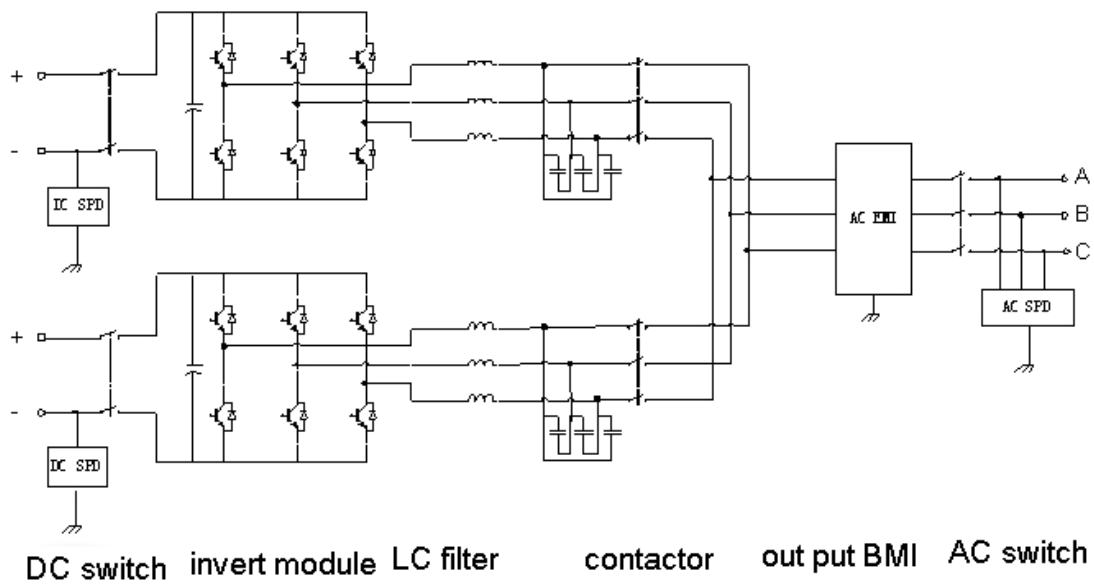

Figure 3-2-1 Growatt CP630TL circuit diagram

**CAUTION**

Although the Growatt CP630TL is no inner transformer, transformer is needed for solar power station.

### 3.3 The layout of the main components

#### 3.3.1 External components

External main components include: LED indicator, LCD touch screen and start-stop knob, emergency stop button, the DC side switch and the AC side switch.

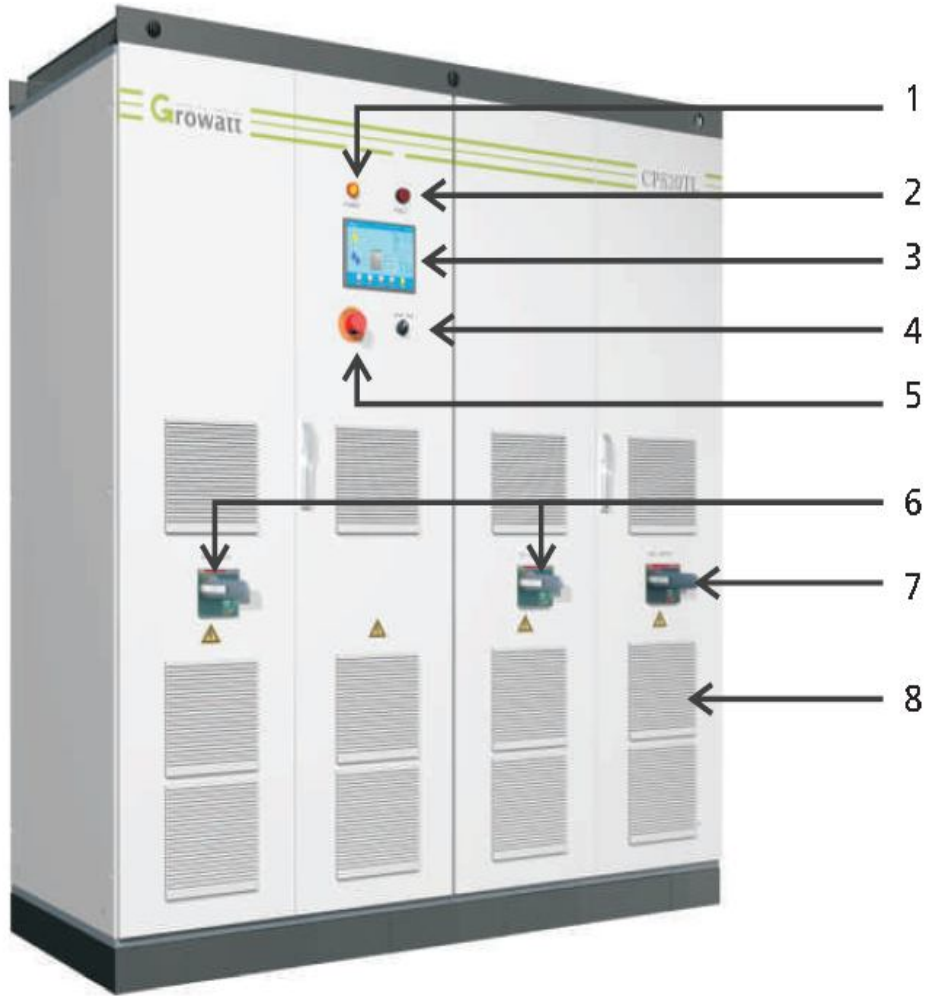

Figure 3 - 3 - 1 - 1 Inverter appearance

No.	Name	Description
1	Power indicator	When power supply is normal, the indicator displays yellow.
2	Inverter malfunction indicator	When inverter is faulty, the indicator displays red.
3	touch Screen LCD	Operation information display, receive control command and parameters setting
4	Off-on knob	only control the grid-side switch, and does not control the

		DC-side switch
5	Emergency STOP	Shut down the inverter when pressed down
6	DC Switch	connect or disconnect the inverter and PV modules
7	Grid Switch	connect or disconnect the inverter and utility grid
8	Dust screen	prevent dust from entering into the inverter

Figure 3 - 3 - 1 Part description

### Indicator

The inverter is designed intelligently, which will automatically start and stop working every day.

There are two LED indicators on the inverter which is used to display the current status of the inverter.



**POWER**



**FAULT**

Figure 3 - 3 - 1 - 2 LED indicators

LED	Description
POWER	The indicator lights when power supply to the inverter is normal.
FAULT	The indicator lights when power supply to the inverter is normal.

Figure 3 - 3 - 2 LED status

### AC/DC main switch

AC switch is used to connect or disconnect the inverter and utility grid. DC switch is used to connect or disconnect the inverter and PV modules. If the AC switch is used in the case of load,

the inverter components will be exposed to considerable stress. Frequent use of the AC switch will lead to damage of the inverter.

### Emergency STOP

**i**

**CAUTION**

The emergency stop button is only used in case of emergency, such as: serious failure in the grid, fire, etc.



Figure 3 - 3 - 1 - 3 Emergency STOP

The emergency stop button immediately disconnects the inverter from both grid and PV arrays, which ensure the safety of the inverter. By pressing the emergency stop button, the device will be locked in the "off" position. Only release the emergency stop button by rotating it clockwise and closing AC, DC breaker, can the inverter resume working normally.

### Off-on knob

It is used to start or stop the inverter.



Figure 3 - 3 - 1 - 4 Off-on knob

Touch screen

It displays the inverter's operating parameters, power generation, and faulty information record. Please refer to Section 6, for details.

## 3.4 Operation mode

There are several operation modes of the inverter.

### 3.4.1 Standby mode

The standby mode refers to powering up the inverter for the first time since installation, but there is not enough power to connect to the grid. When there is enough power from the PV array, it will transfer to grid mode.

### 3.4.2 Grid mode

Process of inverter connecting to the grid:

- 1) PV array connects to the inverter input, and the inverter output connects to transformer, then to the utility grid;
- 2) Close AC and DC breaker and inverter will enter into standby mode.
- 3) When input voltage exceed 450V (inverter startup voltage can be set on LCD, minimum voltage is 450V), the inverter will connect to the grid.



4) Grid-connected inverter will check if the current state meets all the conditions to connect to the grid before it actually connects.

The power generation is automatic. The inverter will detect if DC input and AC grid meets all conditions. When all conditions are met, it will enter into grid mode. When the grid is abnormal, inverter will immediately disconnect from the utility grid, and immediately enter into the fault state.

In this mode, inverter will convert the DC power into AC power and feed into the grid. Meanwhile, inverter will output the power from the PV array in the MPPT (Maximum power point) method, and grid mode is also called MPPT mode.



#### CAUTION

When the ambient temperature is too high, it is normal the inverter reduces the output power. However, if this frequently happens, check the cooling surface of the inverter or place the inverter in better ventilation conditions place. If the inverter fan is dirty, please clean the fan, if there is problem with the inverter internal electrical, please seek help from professional services.

### 3.4.3 Faulty mode

When the PV power system failure, the inverter will immediately disconnect the AC contactor and enters into the fault mode, so as to ensure the safety of the system. Inverter continuous monitors if the fault is eliminated. The inverter will not enter into the grid mode until the fault is eliminated.

### 3.4.4 Permanent faulty mode

When the PV power system is in serious failure, the inverter will immediately disconnect the AC contactor and enters into the Permanent fault mode, so as to ensure the safety of the system. For example: inverter module failure etc. When inverter enter into permanent failure mode, do not repair the inverter, and you should get in touch with the local dealers or call Growatt customer service department for help.

## 3.5 Protection

### Anti-islanding

When the local power grid shutdown due to malfunction or maintenance of equipment, the inverter will be physically cut off the connection to the grid, in order to protect operating personnel working in the electricity grid, and the inverter is in compliance with the relevant standards.

### Lightning protection

Inverter built-in lightning protection module has the DC / AC side lightning over-voltage protection to avoid inverter from being damaged.

More protection features, please refer to the section 6.3.

## 3.6 Storage

If there is a long time before installation or operation, the Growatt CP 500TL should be stored appropriately.

- ✧ The packaging should be restored to its original state;
- ✧ Retain the desiccant in the packaging.
- ✧ The Growatt CP 500TL can only be stored when it is stopped and all the doors are closed in a dry room to protect the internal circuits against dust and moisture.
- ✧ Storage temperature range: -40~55 °C
- ✧ Storage relative humidity range: 5 %~95 %
- ✧ Operating temperature range: -25~55 °C
- ✧ Operating relative humidity range:5 %~95%
- ✧ Max. altitude:2000 m

**CAUTION!**

- Strictly prohibited storage without packing!
- Avoid storage in direct sunlight!
- Keep upright and no stacking on top of the crate.

### 3.7 Dimension

Model	Growatt CP630TL
Size(W*H*D mm)	2000*2200*850

Dimension 3 - 7 Inverter dimension

### 3.8 Label

Inverter label is affixed on the inverter, which contains model and specification information. Do not attempt to tamper with the label information, and the inverter will not be under warranty if the label information is altered, vague or disappeared.

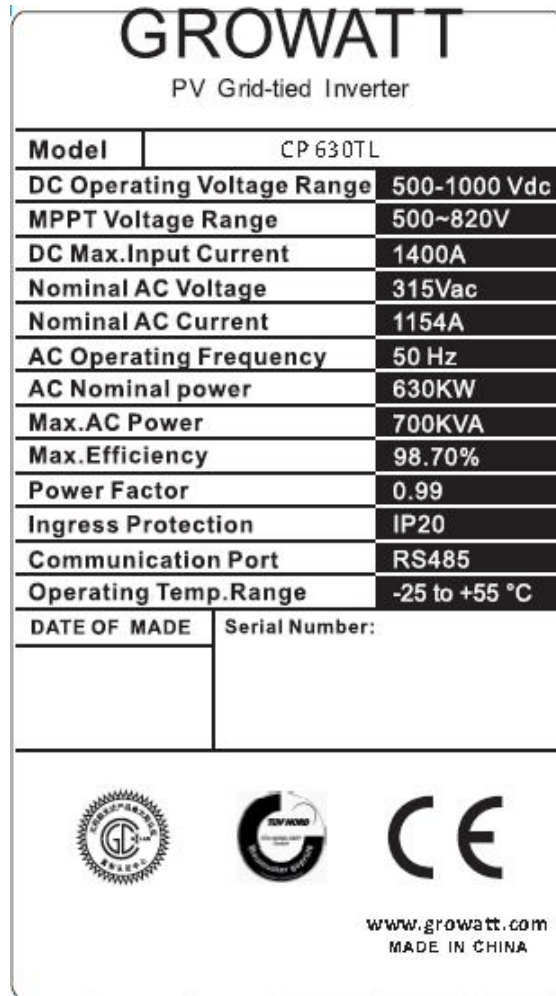

Figure 3 - 8 product label

### 3.9 Packaging information

No.	Name	Unit	quantity	description
1	inverter main unit	pcs	1	Contains cabinet keys
2	user manual	pcs	1	
3	certificate	pcs	1	
4	OT terminal	pcs	8	

Table 3 - 9 Packaging information

## 4 Products installation

### 4.1 Installation condition requirements

To ensure normal operation of the machine, the installation environment is required as follows:

- ✧ The ingress protection of inverter is IP20. Moreover, as this product is an electronic equipment, it shall not be placed in humid environment;
- ✧ Install indoors and avoid sunlight and rain;
- ✧ Ventilation of the room shall be good;
- ✧ The installation environment shall be clean;
- ✧ As some noise will be produced in operation, this equipment shall be installed far from residential quarters;
- ✧ The installation ground shall be even enough, and firm enough to support the weight of inverter;
- ✧ The installation position shall be convenient for maintenance;
- ✧ Ambient temperature range:  $-25^{\circ}\text{C}\sim 55^{\circ}\text{C}$ ;
- ✧ Appropriate space shall be reserved for the machine to ensure ventilation and cooling.

We suggest inverter is installed in the distribution room. The floor, wall clearance, Ventilation equipment and precaution should be designed by professional personnel and satisfy the following requirements.

#### **[Foundation requirement]**

Inverter is required to install on even ground with fire-retardant material as the surface or channel steel support structure, and sag or tilt ground is prohibited. The foundation shall be solid, safe and reliable. The foundation shall be capable of bearing the load of the inverter. Its load bearing ability shall be concerned throughout the installation place selection.

#### **[Clearance space]**

During installation of the inverter, appropriate space shall be left to the wall or other equipments, in order to satisfy the requirements on narrowest maintenance channel, emergency access and ventilation.

In front of the installation place of inverter, a space of 1.5m or more shall be ensured, the back

0.6m or more, the top 0.6m or more to ensure easy installation, cooling and maintenance.

### [Cable trench]

The cable connection of inverter adopts bottom inlet and bottom outlet. Cable trenches are recommended.

The cable trenches are often designed and constructed by the construction side based on relevant standards, with the equipment weight and dimensions required to be considered. Good electrical connection is needed between different cable trenches and GND terminals.

### [Wiring specification]

Cables in the inverter can be classified into either power cables or data cables.

In cabling, the power cable shall be kept far away from, and the cable shall be kept in right angle at cross. The cable shall be as short as possible, and an appropriate distance shall be kept to the power cable. We suggest the DC PV+ and PV- insulation resistance is more than  $V_{max PV}/30mA$ .

The power cable and data access shall be placed in different cable trenches respectively to avoid lengthy routing between the power cable and other cables, so as to reduce the electromagnetic interruption caused by sudden change of the output voltage. The distance among the power cable and data access shall be more than 0.2m. When the cables are crossed, the cross angle shall be 90 degrees, while the distance can be reduced appropriately.

Inverters for use with ungrounded arrays shall have means to measure the DC insulation resistance from the PV input (array) to ground before starting operation.

Inverter Max Power Rating	Minimum Insulation Resistance before connection to the MAINS
$\leq 30kVA$	$500k\Omega$ or $1k\Omega/V * V_{MAX PV}$ ( $k\Omega$ ) whichever is higher
$> 30kVA$	$(5000 * V_{MAX PV})/S_{MAX}$ ( $k\Omega$ ) where $V_{MAX PV}$ is as defined in Part 1, and $S_{MAX}$ is the max apparent power rating of the inverter in VA

### [Ventilation requirement]

In operation, inverter will produce a lot of heat. When ambient temperature is too high, the electrical property of the equipment may be affected, the equipment may even be damaged.

Therefore, the heat release shall be fully considered in designing the control room to ensure operation of the equipment in high efficiency.

### [Ventilation environment]

To satisfy the ventilation requirement of inverter, its installation environment shall meet the

following conditions:

- ※ Inverter shall be prevented from being installed in the place of poor ventilation condition and insufficient air flow;
- ※ The air inlet shall have enough air supplementation.

### **[Ventilation equipment]**

To ensure safe and reliable operation of the equipment, the ambient temperature must be within the permission range  $-25^{\circ}\text{C}\sim 55^{\circ}\text{C}$ , therefore, appropriate ventilation devices must be equipped with to release the heat generated by the equipment. We suggest the ventilation rate is more than  $10000\text{m}^3/\text{h}$ .

- There must be ventilation equipment inside the distribution room to ensure release of the waste heat generated by the inverter from the equipment, and allow for maximum ambient environment temperature. This can be realized from installation of exhaust devices;
- Another fan can be added at the air duct outlet to exhaust the air out and ensure balanced pressure;
- The direction of the air outlet shall be selected according to the local actual wind direction;
- Pay attention to the dustproof measures and waterproof design at the air inlet and outlet;
- If more air ducts are required, its dimensions shall be designed by the professionals according to the air output amount.

### **[Other protections]**

With IP20 of protection level, inverter is appropriate to be installed in dry and clean environment.

Meanwhile, water leakage of the house shall be prevented, as it may damage the inverter.

According to EMC requirement and noise level, the inverter shall be installed in industrial environment.

## **4.2 Tools and spare parts required for whole machine installation**

Tools and spare parts required for installation is as follows:

- Hoisting crane, forklift or fork lift truck (with the capacity for bearing the weight of the inverter)
- Torque wrench

- Screwdriver
- Wire stripper
- Terminal crimping machine
- Heat dryer
- Megger and multimeter

## 4.3 Mechanical installation

### 4.3.1 Transportation of packaged whole machine

#### 【NOTE】

This inverter is transported as an integrated unit, and the user can hoist it from the bottom with a forklift, or move it with a hoisting crane or crane.

**Note 1:** The inverter is integrated and cannot be disassembled either in transportation or installation. Any fault attributed to modification unauthorized by the Growatt is beyond the quality assurance.

**Note 2:** In movement, tilt, violent shake or sudden force upon the inverter shall be prevented, such as sudden down of lifting.

**Note 3:** Please read carefully the labeled parameters to select an appropriate transportation means and storage place.

We suggest the user make use of forklift to move the inverter if possible.







#### CAUTION!

Before the inverter is moved to the designated place, we suggest to lay the DC input cable and AC main power supply cable. As these cables are relatively thick, they are hard to be cabled after the inverter is installed.

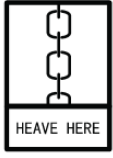
To keep the equipment in a better protective status, please adopt transportation with package as much as possible, and comply with the labels printed on the package in transportation:



Sign	indication
	The gravity centre
	Lifting logo
	Face up to prohibit the inverter horizontally, tilted or upside down
	Handle with care, to avoid the transport environment too intense collision friction damage to the inverter
	Keep away from moisture

Inverters whose packages are not demolished can be moved with forklift, hoisting crane or crane.

In moving, attention shall be paid to the weight painted on the package to ensure enough load capacity of the devices. As the gravity center of the equipment locates at the lower place symmetrical in front and back and left and right, the support point or hoisting point shall be arranged reasonably in transportation.

The forklift transportation is the standard one. The gravity center of the cabinet in transportation should locate between two forks of the forklift. The big-size inverter may block driver's sight, and it shall be treated with cooperation of the aid personnel.

### 4.3.2 Movement and installation of bare machine

#### [Demolish the package of inverter]

Please demolish the packaged cabinet of the equipment according to the following procedures:

**Procedure 1:** Demolish the wood side and roof of the packaged cabinet

**Procedure 2:** Demolish the out-set package material on the machine

**Procedure 3:** Demolish the fastening screws between the machine and the pallet

- ① Demolish the front and back cover lids of the pedestal;
- ② Screw off the hold-down nuts at the bottom of the wood pallet;
- ③ Remove the screws, and the inverter will depart from the wood pallet.

The inverter must be installed on the foundation or foundation plate, therefore, all fastening points (wall anchor and bolt) must be at their correct positions before installation. Mounting dimension of foot margin on foundation is shown in Figure.

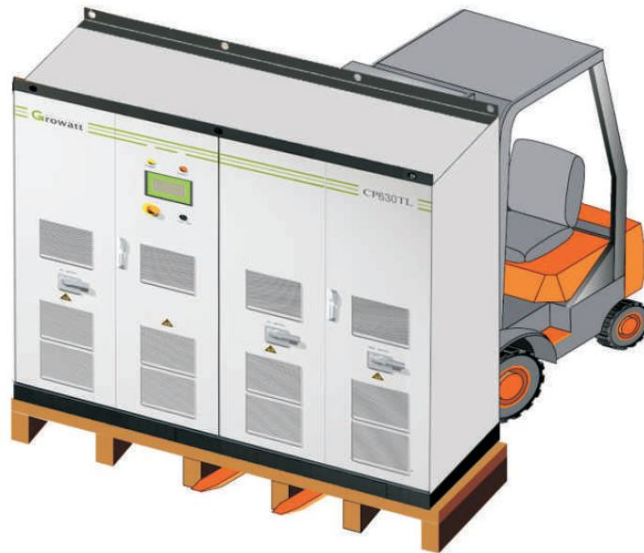

### **[Movement and installation of bear machine]**

The inverter with demolished package can be moved with forklift, hoisting crane, slide rail or crane.

If the package demolished place is far from the final installation place, it can be transported with forklift containing wood pallet. It is shown in Figure.



**Caution, risk of danger**

**CAUTION!**

We must act slowly and gently when transporting the inverter with forklift to avoid violent vibration of the inverter or collision with other objects.



## 4.4 Electrical installation

### 4.4.1 Input and output requirements



**Caution, risk of danger**

**CAUTION!**

- There is a danger of electrical shock of high voltage in inverter's operation; only electricians of professional skills can operate.
- All connections with this equipment shall be done under non-voltage state.
- The inverter may be damaged if input or output terminal is incorrectly plugged.

Failure of acting upon this information may cause serious personnel injury or significant property loss even to death.

#### 1) PV array

The positive and negative open-circuit voltage of the PV array shall not exceed 1000, otherwise, the equipment will be in over-voltage protection state, and cannot work normally. The power of inverter PV array can be 575KW.

Model	Growatt CP630TL
PV Array Power Limit	575KW
PV Array Open-circuit Voltage Limit	1000V

#### 2) Three-phase grid

Inverter will continuously inspect whether the grid satisfy the grid connected conditions. The following is the grid limit for satisfaction of local Grid connected Conditions (requirements in different countries may vary, the value can be setup and please refer to local grid connected regulations for details), and the grid is three-phase grid. Meanwhile, it shall be permitted by local power supply department before install Grid-connected inverted power.

Model	Growatt CP630TL
Grid Voltage Limit	250V-362V
Grid Frequency Limit	45HZ-55HZ/55HZ-65HZ

### 3) Cable requirements

Cable (Cu)	Cable Diameter Requirements (mm <sup>2</sup> )	Aperture
Model	Growatt CP630TL	
PV Array PV+	6*95 mm <sup>2</sup> , or 4*185 mm <sup>2</sup>	Φ10, 30N*m
PV Array PV-	6*95 mm <sup>2</sup> , or 4*185 mm <sup>2</sup>	Φ10, 30N*m
Grid Phase A	6*95 mm <sup>2</sup> , or 3*185 mm <sup>2</sup>	Φ10, 30N*m
Grid Phase B		Φ10, 30N*m
Grid Phase C		Φ10, 30N*m
Earth Wire	More than 50 mm <sup>2</sup> . Green and yellow	Φ10, 30N*m
Communication Wire	0.75mm <sup>2</sup> , shielded Twisted pair	/

## 4.4.2 Preparation for electrical wiring

Before wiring, the users need to open the front door of inverter, and the specific procedures are as follows:

**Procedure 1:** Cut off the circuit breaker at DC&AC sides. As shown in Figure 4-4-2-1, move the Grid switch and the PV switch to the state of "OFF".

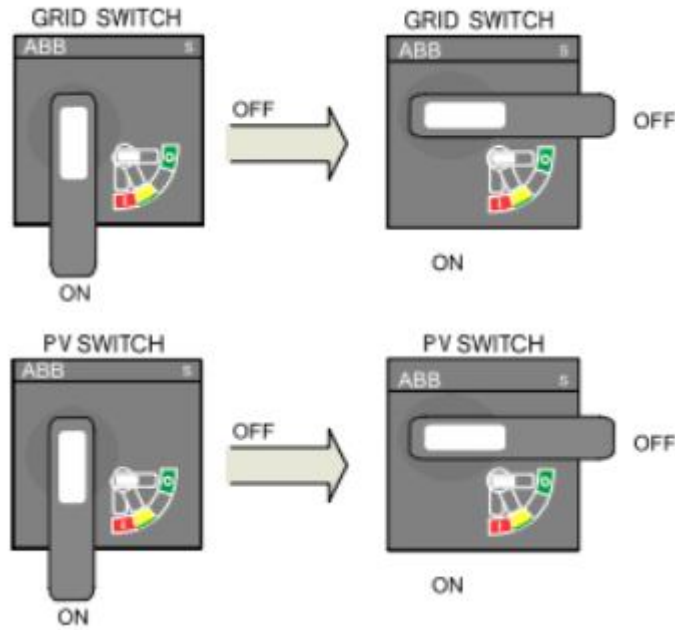

Figure 4-4-2-1 AC&DC Main Switch Status Schema

**Procedure 2:** Open the front door. The unlock schema is shown in Figure 4-4-2-2.

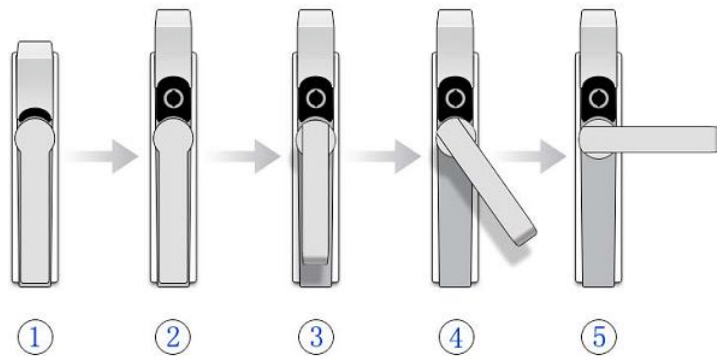

Figure 4-4-2-2 Open Machine's Front Door

**Procedure 3:** Raise the detents, and then close the doors. The schema is shown in Figure 4-4-2-3.

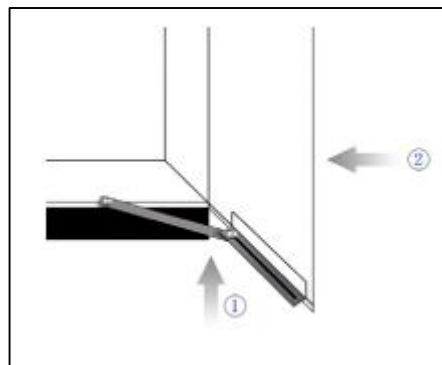

Figure 4-4-2-2 Raise the detents

### 4.4.3 DC side wiring



**Caution, risk of danger**

#### CAUTION!

The positive and negative of the PV array shall not be connected in reverse. A multimeter shall be used to determine the polarity first, and then connect into the corresponding input ends of the inverter.

Specific procedures are as follows:

- 1)** Cut off the distribution circuit breaker at the DC side, and ensure that no voltage on the wire at DC side.
- 2)** Measure the open-circuit voltage of the PV array with a multimeter to ensure that the open-circuit voltage is not higher than 1000V.
- 3)** Determine the positive and negative with a multimeter.
- 4)** Connect the positive of the PV array to the "PV+" of DC input
- 5)** Connect the negative of the PV array to the "PV—" of DC input
- 6)** Please be sure that all wirings are fastened.

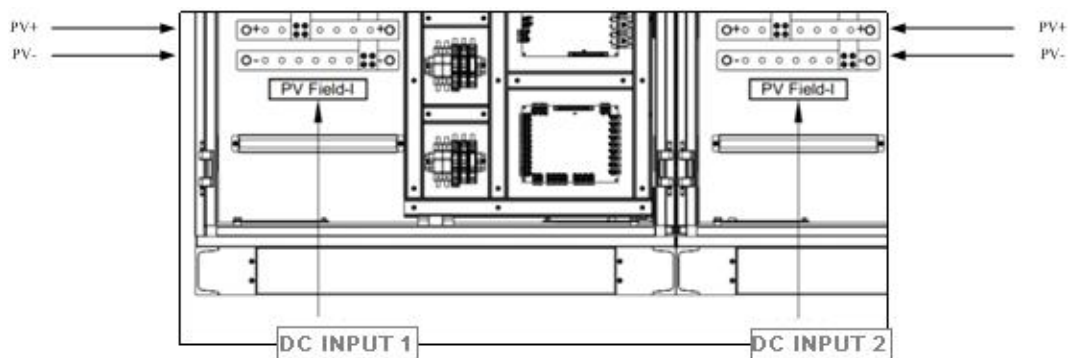

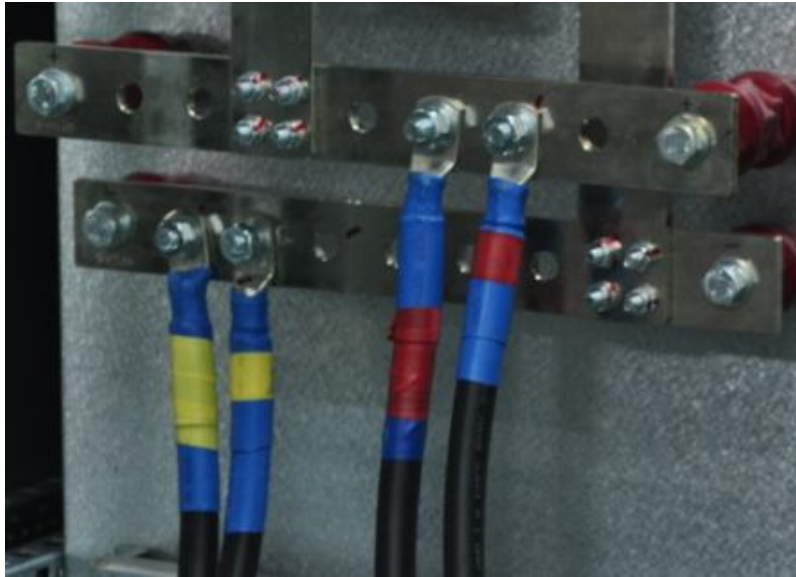

Figure 4-4-3 DC Input Wiring

#### 4.4.4 AC side wiring



**Caution, risk of danger**

##### **CAUTION!**

When connecting the AC grid, cut off the circuit breaker at the AC side to ensure that the AC wire connecting to terminals has no electricity.

##### **Connect AC grid:**

- 1)** Cut off the circuit breaker at AC side, to ensure that the AC wire connecting to terminals has no electricity. Confirm it with a multimeter.
- 2)** Connect "A" of AC output with "L1" of the grid.
- 3)** Connect "B" of AC output with "L2" of the grid.
- 4)** Connect "C" of AC output with "L3" of the grid.

Ensure that the wiring phase sequence at AC side is in consistent with the phase sequence at grid side.

- 5)** Please confirm that the wiring is fastened.



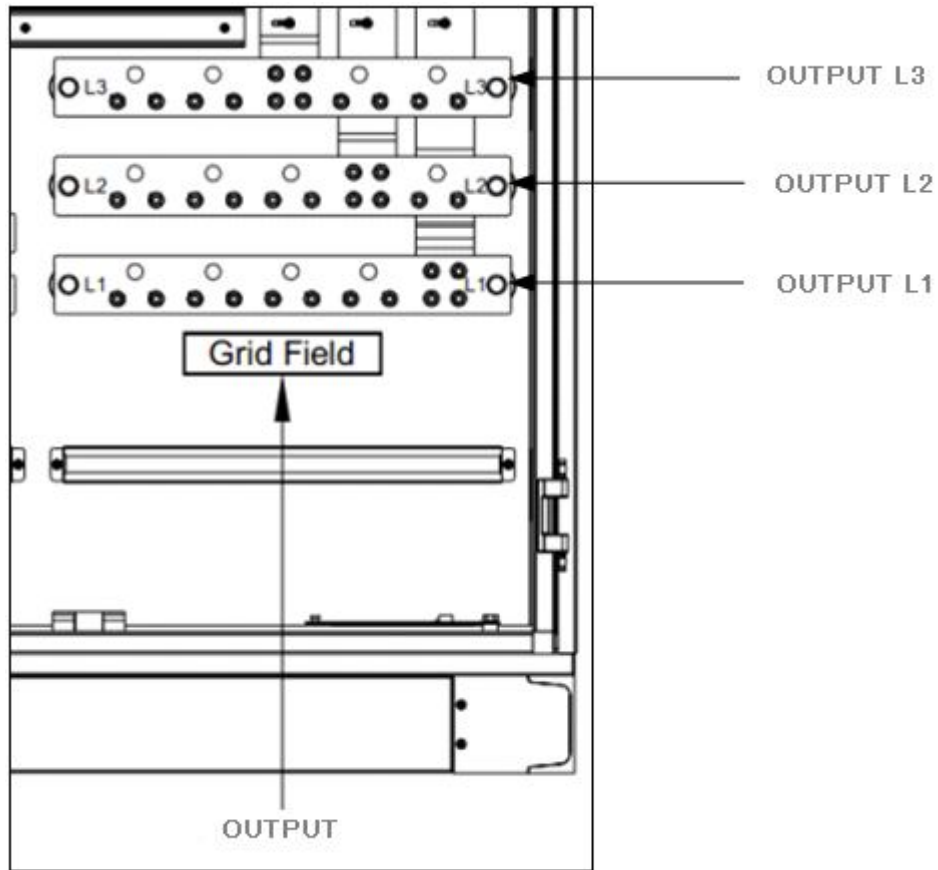

Figure 4-4-4 AC Output Wiring

## 4.4.5 Earthing

Inverter must be earthing well for safety; Please make sure of the connection between PE in power distribution cabinet and PE copper in the inverter good; and make sure the earthing cable more than  $185\text{mm}^2$  and the earthing resistance must satisfy the demand of IEC standard.



Figure 4-4-5 PE copper in the inverter



**Caution, risk of fire hazard**

**WARNING**

There is usually no need to connect DC input terminal with earth for Silicon solar cell;  
But for thin-film solar cell, if one of DC input terminal need to be connected to earth, GFDI device must be used for safety.

All wiring into the channel at the bottom of the inverter to be all the wiring is completed, the connection port must be sealed with dust cotton, to prevent dust from entering the inside of the inverter.



**Caution, risk of danger**

**CAUTION!**

Please do not change the connection of earthing wire that already being, for that may be cause some danger.

## 4.5 Communication

The inverter of Growatt CP series has various communication methods. When the user needs to monitor the operating status of PV power generation system, we provide single-machine and multi-machine control programs, and diversified communication interfaces for customer's selection.

### 4.5.1 RS485 communication

The inverter, through RS485 tandem, is connected with the PC for communication through RS485/RS232 adaptor. Inside the PC, a multi-machine monitoring software ShineNet independently developed by the Growatt is monitoring in real time the operating status of all inverters, as shown in Figure 4-5-1. The RS485 wire should be less than 1000m.

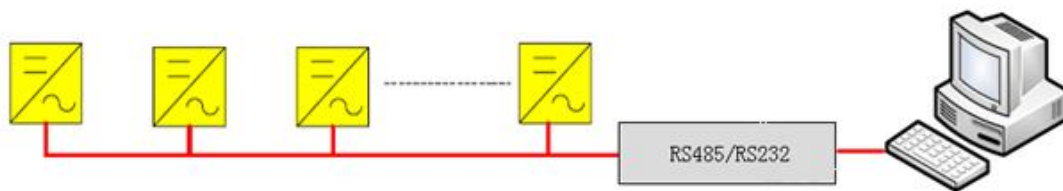

Figure 4-5-1 RS485 Multi-machine Communication

### 4.5.2 Internet communication

There is an Ethernet port on the right side of LCD. Please connect the LCD and Router with Network cable; and then router can make data interaction with serve, and users can communicate with the inverter by internet.

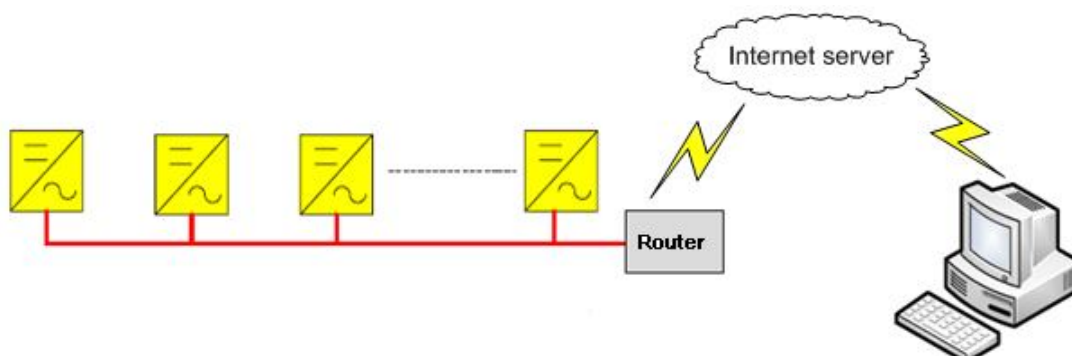

Figure 4-5-2 Internet Communication

## 4.6 Installation inspection

Before the inverter is put into operation, it shall be inspected for installation. Two working men or more shall inspect to ensure correct installation of all installation according to the following table.

<b>Mechanical Installation Items Inspection</b>	
<input type="checkbox"/>	No deformation and damage to inverter.
<input type="checkbox"/>	Inverter's bottom is fixed, and the support is stable and reliable.
<input type="checkbox"/>	Enough space is left around inverter.
<input type="checkbox"/>	The ambient temperature, humidity and ventilation satisfy requirements.
<input type="checkbox"/>	Smooth flow of cooling air.
<input type="checkbox"/>	Complete and reliable sealing protection of cabinet.
<b>Electrical Installation Inspection</b>	
<input type="checkbox"/>	Complete and firm grounding of inverter.
<input type="checkbox"/>	Grid voltage matching the rated input voltage of inverter.
<input type="checkbox"/>	Correct phase sequence of grid connection, and tightening torque meeting requirements.
<input type="checkbox"/>	Correct connection of DC input anode and cathode, and tightening torque meeting requirements.
<input type="checkbox"/>	Correct connection of communication lines, and maintaining a certain distance to other cables.
<input type="checkbox"/>	Correct and legible mark of cable No.
<input type="checkbox"/>	Complete and reliable insulation shields, and legible and firm label of danger warnings.
<b>Other Inspections</b>	
<input type="checkbox"/>	All useless conductive parts tied with insulating ribbon.
<input type="checkbox"/>	No tools, spare parts, conductive dust generated from drilling or other matters left inside the cabinet.
<input type="checkbox"/>	No condensed humidity or icing inside the cabinet.

Table 4-6 Installation Inspection List

## 5 Pilot operation

The chapter will introduce the procedure of pilot operation, including checking PV array voltage, input and output connecting, other preparation working.

## 5.1 Relevant requirements

Before pilot operation, the installation conditions of the equipment shall be examined thoroughly, in particular whether voltages at DC and AC ends are consistent with inverter's requirements, and whether the polarity etc. are correct. Inspect if the system connection meets requirements in relevant standards or codes and if the system is grounded well.



### CAUTION!

Before pilot operation, all switches at AC side and DC side shall ensure to be cut off.

## 5.2 Inspection

### 5.2.1 Inverter inspection

Before power on the inverter, please carry out inspections as the following procedures:

**Procedure 1:** Inspect inverter's installation and wiring conditions based on the Installation Inspection List in Table 4-6;

**Procedure 2:** Ensure the AC&DC circuit breakers are cut off;

**Procedure 3:** Ensure the emergency button is available and works normally.

### 5.2.2 Grid voltage inspection

- Inspect whether the three phases of the inverter is correctively connected with the three phase sequence of the grid.
- Inspect whether the line voltage and frequency are within the prescribed range, and record the value.
- If possible, measure the phase THD (Total Harmonic Distortion), and inspect the curve. If distortion is serious, the inverter may fail to operate.

### 5.2.3 DC side voltage inspection

The DC side shall be connected to the inverter from the Combiner or DC distribution cabinet.

- Ensure correct DC input polarity.
- Measure and record the DC (open-circuit) voltage of each line. Voltages of each line shall be similar, and less than the permitted maximum DC voltage value.

## 5.3 Power on steps

### ● First power-on

Operation procedures for the first power-on and operation of inverter are as follows:

Procedure 1: Screw the handle of circuit breaker at the AC side to "ON" position.

Procedure 2: Screw the handle of circuit breaker at the DC side to "ON" position.

Procedure 3: It takes about 10 seconds to automatically initialize the power inverted circuit and equipment. Then the "POWER" LED lamp on control panel will be on.

Procedure 4: If the DC voltage is lower than the starting voltage (equal to 450Vdc), the touch screen keeps shown "Waiting" (in standby).

Procedure 5: If the DC voltage is higher than the starting voltage (equal to 450Vdc), the inverter will inspect the grid connected conditions. When conditions are satisfied, it will automatically switch to "Normal ", at this moment, the "OPERATION" lamp will be on.

### ● Automatic power-on

When the power-on conditions both at DC and AC sides are satisfied, the inverter will be powered on automatically. After the DC input or AC grid fault is demolished, the inverter will also be powered on automatically.

### ● Manual power-off

In the operation process of the inverter, we can power off the machine through the "OFF" button on the panel. At this moment, the inverter stops work, and stops to transmit the DC energy to grid.



**CAUTION!**

After manual power-off, the machine must be powered on manually, otherwise the inverter is unable to power on.

It still maintains voltage after manual power-off!

## 5.4 Pilot operation completion

The following procedures shall be carried out after the inverter is grid connected.

**Procedure 1:** Inspect whether abnormality exists in the inverter, such as excessive noise, excessive heat, abnormal smell or smoke.

**Procedure 2:** Measure whether inverter connected grid voltage, current and THD are stable.

**Procedure 3:** Operate LCD control panel and inspect whether it displays normally and accurately.

By now, the pilot operation of inverter is fully completed, and we can enter the daily operational maintenance.

## 5.5 Power off steps



### CAUTION!

After the inverter is completely powered off, the general PV switch at solar panel side and the Grid switch at grid side still maintain voltage. If operations are need, please be sure to cut off the outer power completely, and wait for not less than 5 minutes.

1. Exercise the OFF button on LCD operation panel;
2. Cut off PV SWITCH;
3. Cut off GRID SWITCH;
4. Cut off the switch of DC distribution cabinet or combiner;
5. Cut off the switch of AC distribution cabinet.

## 6 GUI instruction

### 6.1 LCD display screen introduction

User can view the information of the inverter operation on the LCD touch screen, as well as setting the operating parameters. In order to facilitate the operation, a menu is provided below.

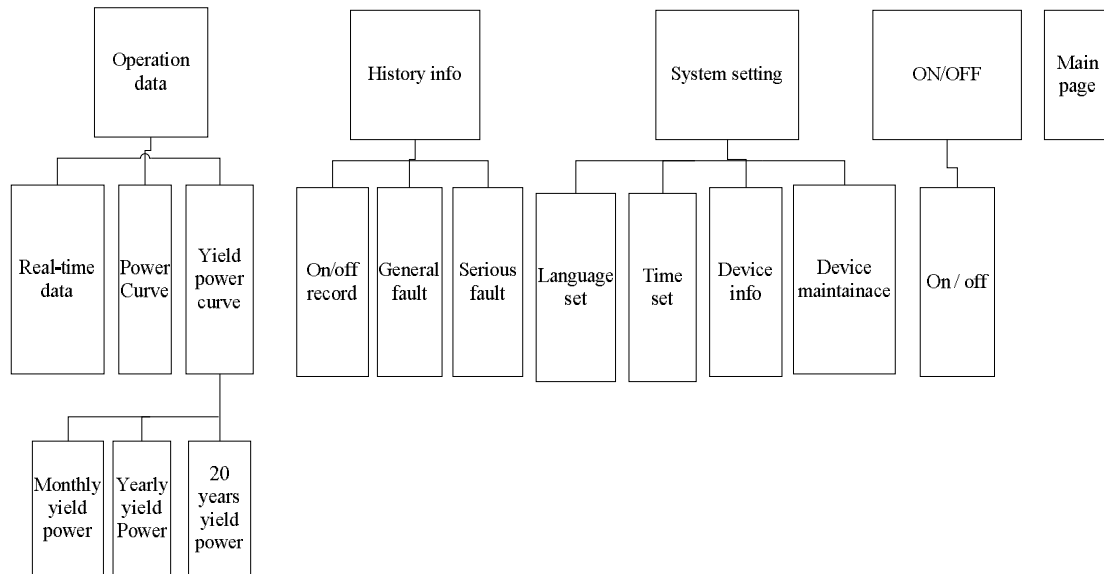

Table 6-1 Growatt CP630TL LCD Menu

After powering on the LCD, it will initialize itself first, and then enter the boot which displays the progress bar of starting up. The main interface will display after finishing the startup (about 20S, if the progress bar has not been finished after 60S, there is communication problem between LCD and control board). Then you can begin to read the information and set the parameters.

Inverter communication state, station number and system time is displayed at the top of each page of the LCD.

Each page has five commonly used function keys: "run data" "historical information" "system settings" "Home" at the below of the page. The five commonly used keys corresponding sub-menu are under the button, and it will be marked green after selected.



## 6.2 LCD operation

### 6.2.1 Initialization

Initialization interface: The initialization interface will be divided into two parts, the LCD initialization and inverter initialization.

LCD initialization: it will be finished after powering up for 20S.

Inverter initialization: After LCD initialization completed, the inverter boot screen will pop up.

The initialization progress will be displayed on the LCD. After finishing initialization which takes about 30S, it will automatically switch to [home page], and operation on the LCD can be proceeded.

**Note: The default language is Chinese.**

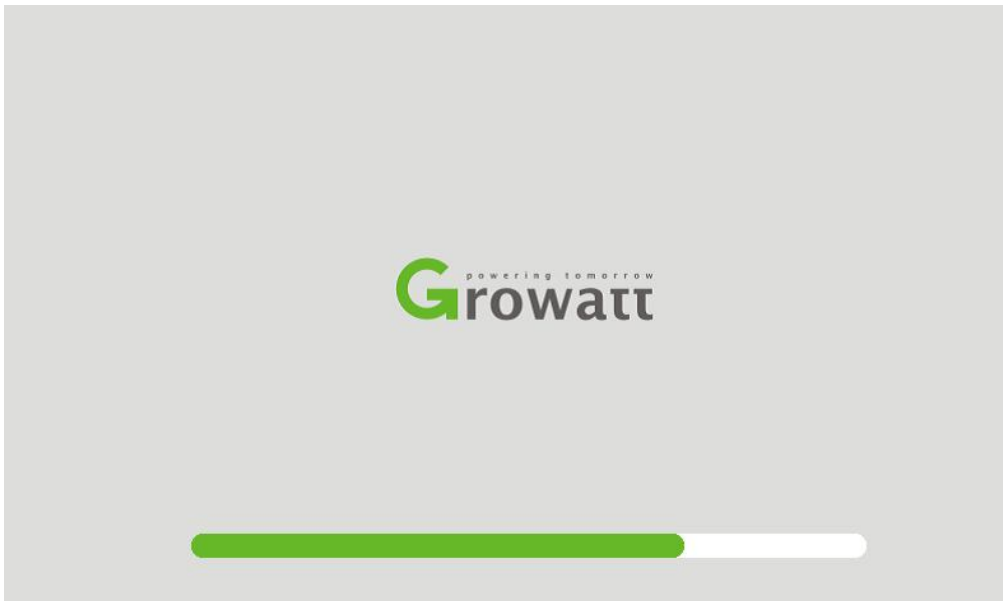

### 6.2.2 Home page

Clicking “Home” button in any interface will enter into the Home page.

The operating status of the inverter output power, safety standard, model, input and output voltage, current information can be viewed in the page. Pressing the following key can switch to other

pages.



### 6.2.3 ON/OFF interface

Clicking “ON/OFF” button in any interface will enter into this interface.

There are “ON” and “OFF” button which is used to turn on and turn off the inverter.

After selecting, a sub-window will pop up for confirmation: Yes/No.

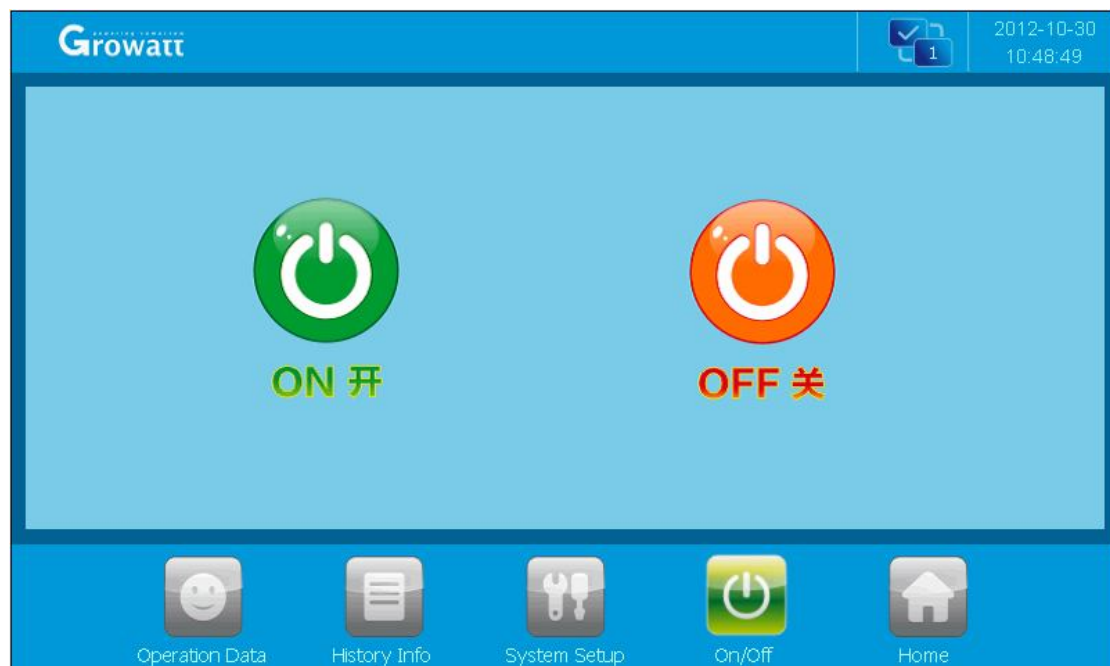

## 6.2.4 System setting

Clicking “System setting” button in any interface will enter into this interface.

Submenu: language settings, time settings, inverter information, maintenance. Pressing the left button can enter into the corresponding submenu interface. The default one is language setting interface.



Language Settings: Select language, currently it only supports Chinese, English (default language is Chinese).



Time settings: system time setting (if the date and time displayed on LCD is not inconsistent with the actual date and time, they can be modified here)



Device Information: This page shows the manufacturer, inverter serial number, hardware and software version information, and the date of manufacturing.



Maintenance: the interface requires a password to login. It is for electrician and maintenance personnel who are fully familiar with the structure and working principle of the PV grid system only, in order to avoid damage to personal safety and the inverter.

## 6.2.5 Historical information

Clicking “historical information” can enter into the sub-menu of the "historical information".

The submenu includes: The inverter ON and OFF time record, history of failure, serious historical failure.

The inverter ON and OFF time record: ON and OFF time record can be found in a total of 20 by pressing the flip button.



History of failure: all the common history of failure details can be found by flipping the page up and down.

The common fault information, see table 6.3.1.



History of serious failure: a total of 20 items of historical serious failure information can be found in details.

Please refer to table 6.3.2.



## 6.2.6 Operation data

Clicking the “Operation data” in any interface will enter into the submenu of “operation data”.

The sub-menu includes: real-time data, the power curve, and energy yield figure. Pressing the left button can enter into the corresponding sub menu interface. The default interface is the real-time data interface.

Insert USB Disk on the back of the LCD display, and the real time operation data will be stored in the USB Disk in every minute. Inverter will create a “CSV” format file every month in the USB disk for data storage.

Real-time data: current PV power generation parameters and real-time data including the grid voltage, the grid frequency, the grid current, DC input voltage, DC input current, the internal temperature of the chassis as well as the total power generation time (updated in real time). When total power is more than 100,000KW, it will be measured by MK; when total power is less than 100,000KW, it will be measured by KW.



Power curve: daily yield displayed in bar chart (updated every 12 minutes).

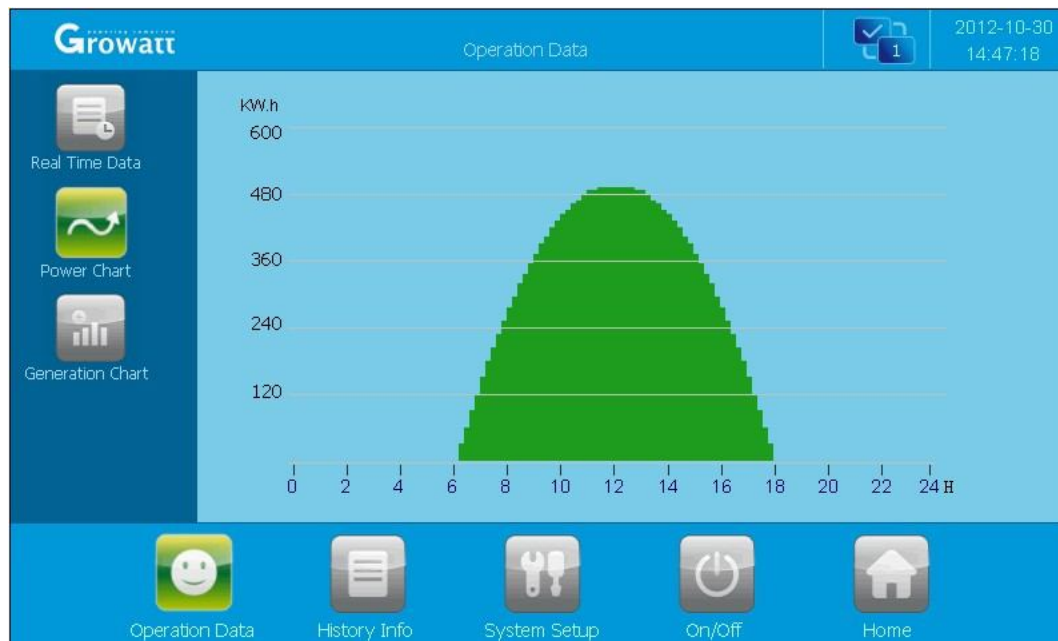

Energy yield: Clicking this button can enter into submenu.

Monthly yield: daily yield displayed in bar chart (updated every 12 minutes).





✧ Yearly yield: monthly yield displayed in bar chart (updated every 12 minutes).



✧ 20 years yield: yearly yield displayed in bar chart.



Pressing "Back" can return to "real time data".

## 6.3 LCD display information schedule

### 6.3.1 General history failure table

No.	information
1	DC_Inverse_Failure
2	IGBT_Failure
3	EEPROM_Write_Failure
4	EEPROM_Read_Failure
5	AC_MainContactor_Failure
6	AC_SlaveContactor_Failure
7	GFDI_Failure
8	GFCI_Failure
9	DC1_VoltHigh_Fault
10	DC2_VoltHigh_Fault
11	DC1_CurrHigh_Fault

12	DC2_CurrHigh_Fault
13	DC1_Insulation_Fault
14	DC2_Insulation_Fault
15	DC1_OCP_Fault
16	DC2_OCP_Fault
17	INT_DC1_OverVolt_Fault
18	INT_DC2_OverVolt_Fault
19	INT_DC1_OverCurr_Fault
20	INT_DC2_OverCurr_Fault
21	IGBT_Module1_Fault
22	IGBT_Module2_Fault
23	L1_OCP_Fault
24	L2_OCP_Fault
25	INT_L1_OverCurr_Fault
26	INT_L2_OverCurr_Fault
27	AC_NoUtility_Fault
28	AC_GridPhaseSeque_Fault
29	AC_PLL_Fault
30	AC_Volt_Unbalance_Fault
31	AC_Curr_Unbalance_Fault
32	AC_WU_OverVolt_Fault
33	AC_WU_UnderVolt_Fault
34	AC_VW_OverVolt_Fault
35	AC_VW_UnderVolt_Fault
36	AC_UV_OverVolt_Fault
37	AC_UV_UnderVolt_Fault
38	AC_OverFreq_Fault
39	AC_UnderFreq_Fault
40	AC_GridCurr_DcHigh_Fault

41	AC_L1Curr_DcHigh_Fault
42	AC_L2Curr_DcHigh_Fault
43	AC_GridCurr_High_Fault
44	AC_L1Curr_High_Fault
45	AC_L2Curr_High_Fault
46	AC_Overload_Fault
47	AC_Lightload_Fault
48	AC_BackFeed_Fault
49	LVRT_Fault
50	Module1_OverTemp_Fault
51	Module2_OverTemp_Fault
52	Inductor1_OverTemp_Fault
53	Inductor2_OverTemp_Fault
54	Transformer_OverTemp_Fault
55	LowTemp_Fault
56	EPO_Stop
57	KeyEmergencyStop
58	LcdEmergencyStop
59	Door_Open_Fault
60	AC_MainContactor1_Fault
61	AC_MainContactor2_Fault
62	AC_MainContactor3_Fault
63	AC_SlaveContactor_Fault
64	GFDI_Ground_Fault
65	GFDI_HallSense_Fault
66	GFDI_AirSwitch_Fault
67	GFDI1_Fault
68	GFDI2_Fault
69	RISO1_Fault

70	RISO2_Fault
71	GFCI1_Fault
72	GFCI2_Fault
73	AC_Fuse1_Fault
74	AC_Fuse2_Fault
75	Fault_Feedback_Warning
76	Fan_1_Fault_Warning
77	Fan_2_Fault_Warning
78	Fan_3_Fault_Warning

Table 6.3.1 General history failure table

### 6.3.2 Serious fault history

No.	information
1	Grid voltage too high
2	Grid voltage too low
3	Grid frequency too high
4	Grid frequency too low
5	DC over-voltage protection
6	DC over-voltage protection
7	AC current unbalanced
8	Grid voltage unbalanced
9	PV Ground fault protection
10	AC over-current protection
11	LVRT protection
12	inverter internal problem protection
13	DSP problem protection
14	DC breaker open circuit
15	inverter temperature warning

16	inverter temperature too high
17	lightning protection devices failure
18	Overheating protection
19	Anti-discharge protection
20	Reverse polarity
21	Normal shutdown
22	Malfunction shutdown
23	Alarm

Figure 6.3.2 Serious historical fault table

### 6.3.3 Inverter status

No.	description
0	waiting
1	checking
2	grid connected
3	fault
4	Permanent fault
5	Communication failure

Figure 6.3.3 inverter status table

## 7 Routine maintenance

### 7.1 Replacing the dust screen

When the inverter fails, the inverter will automatically disconnect from the power grid, and display the alarm information. When there is problem with the utility grid or the inverter is disconnected manually, the inverter will shut down immediately to avoid islanding. When the grid restored to be normal, inverter can automatically start. Normally there is no maintenance or calibration required, however, the dust screen should always keep clean. It needs to be replaced

when it is dirty.

Procedure of the dust screen replacement:

- 1) The front and back cover can be seen after opening the front and back cover of the inverter.
- 2) Open front and back dust cover from the bottom of the dust cover.
- 3) Take away the dust screen and insert a clean one.
- 4) Place the dust cover in the original place and fix it.

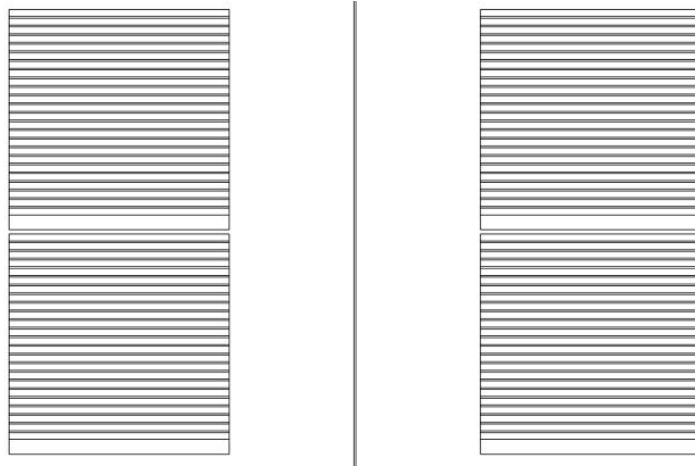

Figure 7 - 1 Dustproof device

i

In order to ensure the normal operation of the inverter , dust screen is required to clean regularly.

## 7.2 Regular maintenance

In order to ensure the normal operation of the inverter, regular maintenance work is required.

Recommended routine maintenance cycle and work, as shown in Table 7-2.

Table 7-2 Routine maintenance work

maintenance item	cycle
Read data from data logger	every month
clean heat sink of the power module	every month

Check the dust, moisture or condensation inside the cabinet	every month
Check the cable connections, and fix the screw if necessary.	every month
Check the warning label, add or replace some if necessary.	every month
Manual checks AC and DC circuit breakers	every month
Check that the emergency stop button, and the LCD stop function	every month
Check if there is abnormal sound when inverter is operating.	every week



### Caution, risk of danger

All maintenance operations must be carried out in the condition that DC side and AC side of the inverter, PV module and AC distribution cabinet switch are all disconnected.

Maintenance must be proceeded only after AC and DC disconnected for at least 5 minutes, in order to avoid electric shock!

## 7.3 Waste disposal

The inverter will not cause environmental pollution, since the all the components meet the requirements of environmental protection. According to environmental protection requirements, user shall dispose the inverter in accordance with the relevant laws and regulations.



## 8 Appendix

### 8.1 Specification

Rating	Units	Value
PV input quantities:		
V <sub>MAX</sub> PV (absolute maximum)	d.c. V	1000
PV input operating voltage range	d.c. V	450-1000
Maximum operating PV input current	d.c. A	1450
I <sub>SC</sub> PV (absolute maximum)	d.c. A	1450
Max. inverter backfeed current to the array	a.c. or d.c. A	1450
a.c. output quantities:		
Voltage (nominal or range)	a.c. V	315
Current (maximum continuous)	a.c. A	1160
Frequency (nominal or range)	Hz	50
Power (maximum continuous)	W (or VA with PF)	630K
Power factor range	/	>0.9
Maximum output fault current	a.c. A (peak and duration), or RMS	1296 (RMS)
Maximum output overcurrent protection	a.c. A	1296
Weight unit	kg	1620
Ingress Protection	/	IP20
Environmental category	indoor	
Suitability for wet locations	not	
Pollution degree	II	
Elect.protection class	Class I	
Overvoltage category	Category III for AC output category II for DC input	
Mains connection	Permanent connection	
Transformer info	Without isolating Transformer	
Insulation class	Class H	

## 8.2 software version

SSCP\_DSP\_V1.0.00

## 8.3 Growatt Factory warranty

This certificate represents a 5 year warranty for the Growatt inverter products listed below. Possession of this certificate validates a standard factory warranty of 5 years from the date of purchase.

### Limited Product Warranty

(Applicable under normal application, installation, use and service conditions)

Growatt warrants the above listed products to be free from defects and/or failure specified for a period not exceeding five (5) years from the date of sale as shown in the Proof of Purchase to the Original purchaser.

The warranties described in these “Limited Warranties ” are exclusive and are expressly in lieu of and exclude all other warranties, whether written, oral, express or implied, including but not limited to, warranties of merchantability and of fitness for a particular purpose, use ,or application, and all other obligations or liabilities on the part of GROWATT , unless such other obligations or liabilities are expressly agreed to it in writing signed and approved by GROWATT , GROWATT shall have no responsibility or liability whatsoever for damage or injury to persons or property, or for other loss or injury resulting from any cause whatsoever arising out of or related to the modules, including, without limitation, any defects in the modules or from use or installation. Under no circumstances shall GROWATT be liable for incidental , consequential or special damages howsoever caused; loss of use, loss of production, loss of revenues are therefore specifically and without limitation excluded to the extent legally permissible, GROWATT ’s aggregate liability, if any, in damages or otherwise, shall not exceed the invoice as paid by the customer.

The “Limited Product Warranties” described above shall not apply to, and Growatt shall have no obligation of any kind whatsoever with respect to, any inverter which has been subjected to:

- Misuse, abuse, neglect or accident;
- Alteration, improper installation or application;
- Unauthorized modification or attempted repairs;
- Insufficient ventilation of the product;
- Transport damage;
- Breaking of the original manufacturers seal;
- Non-observance of Growatt installation and maintenance instruction;
- Failure to observe the applicable safety regulations
- Power failure surges, lighting, flood, fire, exposure to incorrect use, negligence, accident, force majeure, explosion, terrorist act, vandalism or damage caused by incorrect installation, modification or extreme weather conditions or other circumstances not reasonably attributable to Growatt.

The warranty shall also cease to apply if the product cannot be correctly identified as the product of Growatt. Warranty claims will not be honored if the type of serial number on the inverters have been altered, removed or rendered illegible.

### **Liability**

The liability of Growatt in respect of any defects in its PV inverters shall be limited to compliance with the obligations as stated in these terms and conditions of warranty. Maximum liability shall be limited to the sale price of the product. Growatt shall accept no liability for loss of profit, resultant of indirect damage, any loss of electrical power and / or compensation of energy suppliers within the express meaning of that term.

The warranty rights as meant herein are not transferable or assignable to any third party excepting the named warranty holder.

## **8.4 Contact**

If you have technical problems concerning our products, contact your installer or Growatt. During inquiring, please provide below information:

- Inverter type
- Modules information
- Communication method
- Serial number of Inverters
- Error code of Inverters
- Display of inverters

### **Growatt New Energy Technology Co., Ltd.**

Building B, Jiayu Industrial Zone,  
#28 Guanghui Road, Longteng Community, Shiyan,  
Baoan District, Shenzhen, P.R. China

Tel: +86 (0)755 2951 5888

Fax: 86 (0)755 2951 8158

Email: [service@ginverter.com](mailto:service@ginverter.com)

Website: [www.ginverter.com](http://www.ginverter.com)

Importer: