



H-T60

Installation and Operation Manual

MAEN824E, 2009-03

English

H-T60 Installation and Operation Manual

Foreword

H-T60 is a Human Machine Interface (HMIs) with a 5.7" STN Liquid Crystal Display, and is water- and dust-resistant according to IP65/NEMA4X (indoor use only).

H-T60 is CE-marked and meets your need to be highly transient-resistant while in operation.

Also, its compact design makes connections with other machinery more flexible, thus achieving the optimal performance of your machines.

H-Designer is used to design applications of H-T60; it is reliable, user-friendly and compatible with many models.

© Beijer Electronics AB, MAEN824E, 2009-03

Please read the entire installation manual prior to installing and using this equipment. Only qualified personnel may install, operate or repair this equipment. Beijer Electronics AB is not responsible for modified, altered or renovated equipment. Because the equipment has a wide range of applications, users must acquire the appropriate knowledge to use the equipment properly in their specific applications. Persons responsible for the application and the equipment must themselves ensure that each application is in compliance with all relevant requirements, standards and legislation in respect to configuration and safety. Only parts and accessories manufactured according to specifications set by Beijer Electronics AB may be used.

BEIJER ELECTRONICS AB SHALL NOT BE LIABLE TO ANYONE FOR ANY DIRECT, INDIRECT, SPECIAL, INCIDENTAL OR CONSEQUENTIAL DAMAGES RESULTING FROM THE INSTALLATION, USE OR REPAIR OF THIS EQUIPMENT, WHETHER ARISING IN TORT, CONTRACT, OR OTHERWISE. BUYER'S SOLE REMEDY SHALL BE THE REPAIR, REPLACEMENT, OR REFUND OF PURCHASE PRICE, AND THE CHOICE OF THE APPLICABLE REMEDY SHALL BE AT THE SOLE DISCRETION OF BEIJER ELECTRONICS AB.

Contents

1	Safety Precautions	5
2	Installation	7
2.1	Package Contents.....	7
3	Product Specifications	8
3.1	Description of Parts	12
3.2	External and Cut-out Dimensions	13
3.3	Mounting Procedure	13
3.4	Grounding.....	14
3.5	Power Supply and Wiring	15
4	Dip Switches	16
5	Communication Ports	17
6	LCD Contrast Adjustment	18
7	Operation	19
7.1	Self Test	19
7.2	System Menu	20
7.3	Key Pad.....	21
7.4	Bench and Function Tests	22
7.5	Setting Parameters.....	22
7.6	Downloading an Application	23
7.7	Uploading an Application	24
7.8	Uploading/Downloading a Recipe	25
7.9	Copying an Application	26
7.10	Passwords.....	27

1 Safety Precautions

Both the installer and the owner and/or operator of the operator terminal must read and understand this installation manual.

General

- Only qualified personnel may install or operate the operator terminal.
- The operator terminal must be installed according to the installation instructions.
- The operator terminal is designed for stationary installation on a plane surface, where the following conditions are fulfilled:
 - no high explosive risks
 - no strong magnetic fields
 - no direct sunlight
 - no large, sudden temperature changes
 - for use in Pollution Degree 2 Environment
 - for use on the flat surface of Types 1 and 4X (indoor use only) enclosures
- Never allow fluids, metal filings or wiring debris to enter any openings in the operator terminal. This may cause fire or electrical shock.
- The operator terminal fulfills the requirements of article 4 of EMC directive 2004/108/EC.
- Storing the operator terminal where the temperature is lower/higher than recommended in this manual can cause the LCD display liquid to congeal/ become isotopic.
- The LCD display liquid contains a powerful irritant. In case of skin contact, wash immediately with plenty of water. In case of eye contact, hold the eye open, flush with plenty of water and get medical attention.
- The supplier is not responsible for modified, altered or reconstructed equipment.
- Use only parts and accessories manufactured according to specifications of the supplier.
- Peripheral equipment must be appropriate for the application and location.
- The figures in this manual serves an illustrative purpose. Because of the many variables associated with any particular installation, the supplier cannot assume responsibility for actual use based on the figures.
- The supplier neither guarantees that the operator terminal is suitable for your particular application, nor assumes responsibility for your product design, installation or operation.

Power source

- The operator terminal is equipped with a 24 V DC input. Supply power other than 24 V DC \pm 15% will severely damage the operator terminal. Thus, check the power supply supporting the DC power regularly.

Grounding

- Without grounding, the operator terminal may be severely affected by excess noise. Make sure that the grounding is done properly from the power connector at the rear side of the operator terminal. When power is connected, make sure that the wire is grounded.
- Use a cable of at least 2 mm² (AWG 14) to ground the operator terminal. Ground resistance must be less than 100 Ω (class3). Note that the ground cable must not be connected to the same ground point as the power circuit.

Installation

- Communication cables must be separated from power cables for operational circuits. Only use shielded cables to avoid unpredictable problems.

During Use

- Emergency stop and other safety functions may not be controlled from the operator terminal.
- Do not use too much force or sharp objects when touching the keys, display etc.

Service and Maintenance

- Only qualified personnel should carry out repairs.
- The agreed warranty applies.
- Before carrying out any cleaning or maintenance operations, disconnect the equipment from the electrical supply.
- Clean the display and surrounding front cover with a soft cloth and mild detergent.
- Replacing the battery incorrectly may result in explosion. Only use batteries recommended by the supplier.

Dismantling and Scrapping

- The operator terminal or parts thereof shall be recycled according to local regulations.
- The following components contain substances that might be hazardous to health and the environment: lithium battery, electrolytic capacitor and display.

2 Installation

2.1 Package Contents

The following parts are found in the box:

- Operator terminal H-T60

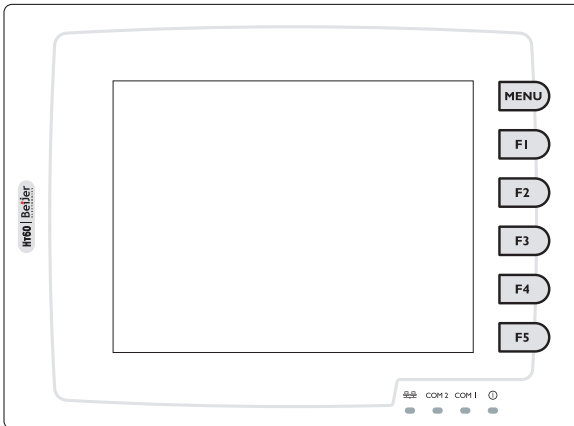

- 6 installation fasteners

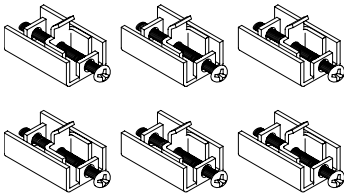

- Power connector (connected to the 24 V DC power input)



- Installation and operation manual (MAEN824E)

3 Product Specifications

H-T60t Models:

Parameter	H-T60t-Ne	H-T60t-Pe	H-T60t-S
Front panel, W x H x D	195.0 x 145.0 x 6.0 mm		
Mounting depth	59.1 mm		
Cut-out dimensions	185.8 x 135.8 mm		
Front panel seal	IP 65/NEMA 4X (indoor use only)		
Keypad specifications	1 "Menu"-key and 5 user-defined function keys (F1-F5). Pressure: 350 ± 50 gf operating force. Lifetime: over 1,000,000 activations.		
Weight	0.81 kg		
COM 1	9-pin female connector: RS232/RS485		
COM 2	25-pin female connector: RS232/RS422/RS485		
USB port	Yes		-
CF card port	Yes		-
Ethernet	Yes	-	
Flash ROM	4 MB		
RAM	512 KB		
CPU	32-bit RISC		
Battery backed memory	512 KB		
Data/Recipe	512 KB		-
Real time clock	Yes (with rechargeable lithium battery)		
Display	Color TFT LCD, 64K colors, 320 x 240 pixels.		Color TFT LCD, 256 colors, 320 x 240 pixels.
	LED backlight lifetime: approximately 30,000 h at 25 °C		
Active area of display, W x H	117.2 x 88.4 mm. 40 x 30 characters of 8 x 8 size can be displayed.		
Display adjustment	-		
Touch screen	Analog		
Power supply	24 V DC ± 15%. Less than 20 W.		

Parameter	H-T60t-Ne	H-T60t-Pe	H-T60t-S
Ambient temperature	0 ° to +50 °C		
Storage temperature	-10 ° to +60 °C		
Ambient humidity	20 - 90% RH non-condensed		
Vibration endurance	0.5 mm displacement, 10-55 Hz, 2 hours per X-, Y- and Z-axis directions		
Shock endurance	10 G, 11 ms 3 times in each direction of X-, Y- and Z-axes		
CE	EN61000-6-4, EN61000-6-2		
Cooling	Natural cooling		

H-T60b Models:

Parameter	H-T60b-Ne	H-T60b-Pe	H-T60b-S
Front panel, W x H x D	195.0 x 145.0 x 6.0 mm		
Mounting depth	59.1 mm		
Cut-out dimensions	185.8 x 135.8 mm		
Front panel seal	IP 65/NEMA 4X (indoor use only)		
Keypad specifications	1 "Menu"-key and 5 user-defined function keys (F1-F5). Pressure: 350 ± 50 gf operating force. Lifetime: over 1,000,000 activations.		
Weight	0.81 kg		
COM 1	9-pin female connector: RS232/RS485		
COM2	25-pin female connector: RS232/RS422/RS485		
USB port	Yes		-
CF card port	Yes		-
Ethernet	Yes	-	
Flash ROM	4 MB		
RAM	512 KB		
CPU	32-bit RISC		
Battery backed memory	512 KB		
Data/Recipe	512 KB		-
Real time clock	Yes (with rechargeable lithium battery)		
Display	Mono STN LCD, 16 shades of blue, 320 x 240 pixels, CCFT backlight lifetime: approximately 50,000 h at 25 °C		
Active area of display, W x H	117.2 x 88.4 mm. 40 x 30 characters of 8 x 8 size can be displayed.		
Display adjustment	Via touch screen		
Touch screen	Analog		
Power supply	24 V DC ± 15%. Less than 20 W.		
Ambient temperature	0 ° to +50 °C		
Storage temperature	-10 ° to +60 °C		
Ambient humidity	20 - 90% RH non-condensed		

Parameter	H-T60b-Ne	H-T60b-Pe	H-T60b-S
Vibration endurance	0.5 mm displacement, 10-55 Hz, 2 hours per X-, Y- and Z-axis directions		
Shock endurance	10 G, 11 ms 3 times in each direction of X-, Y- and Z-axes		
CE	EN61000-6-4, EN61000-6-2		
Cooling	Natural cooling		

3.1 Description of Parts

Front

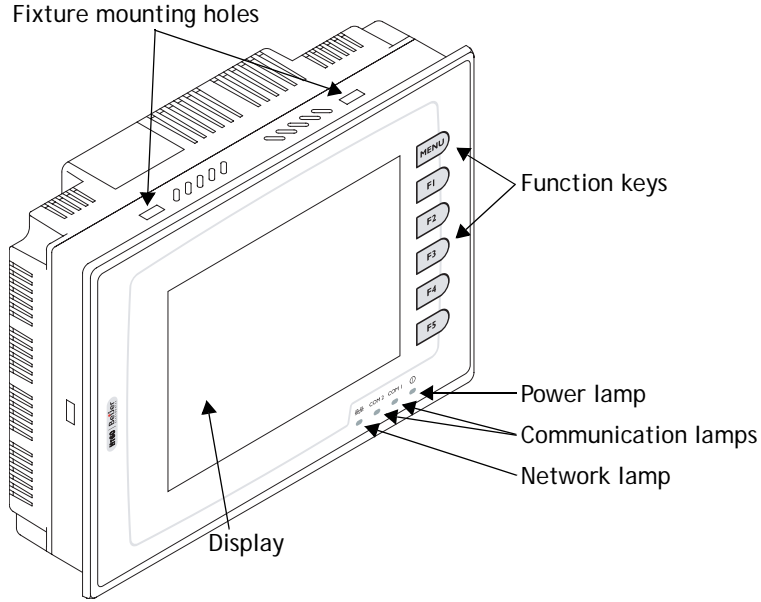

Back

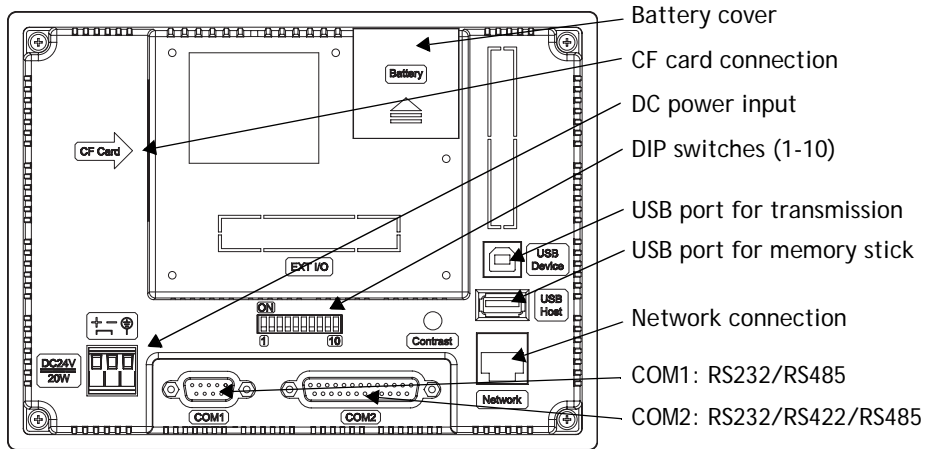

3.2 External and Cut-out Dimensions

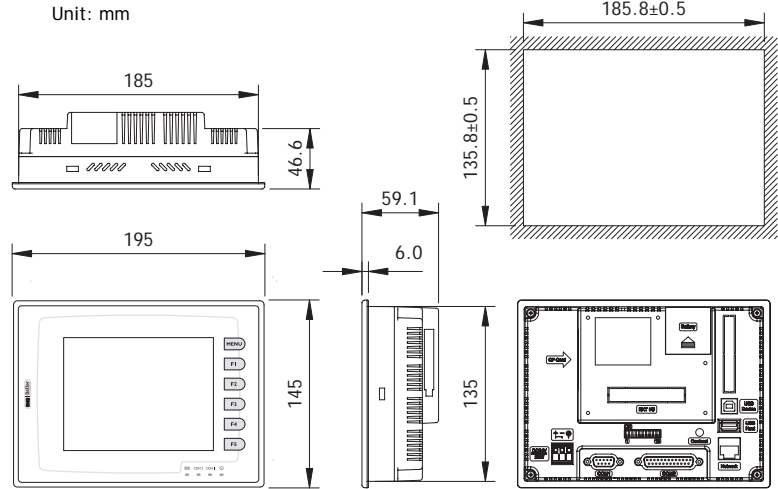

3.3 Mounting Procedure

1. Cut out the control front panel to match the dimensions (mm) below.

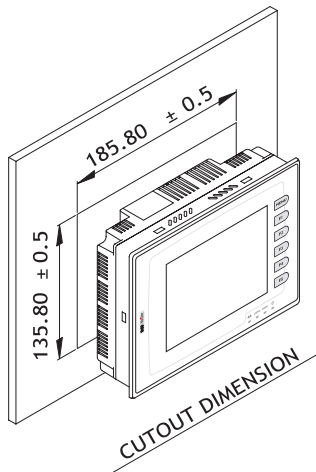

2. Mount the operator terminal into the cut-out. Insert the fixtures to the holes on the unit and fasten the screws into the front panel. Do not tighten the screws with too much or uneven force, or it may cause the deformation of the operator terminal.

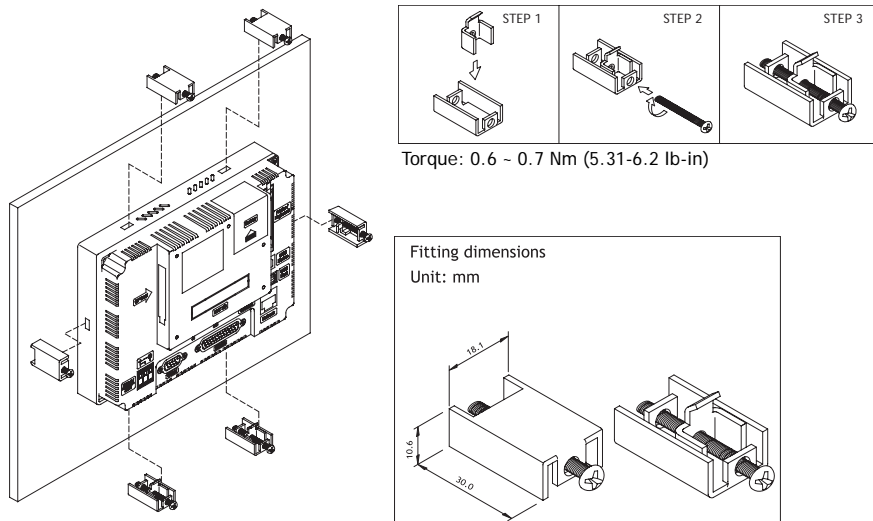

3. The operator terminal is to be installed within the angle of 0 to 135 ° as shown below.

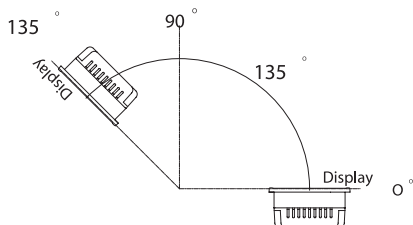

3.4 Grounding

To make sure that the operator terminal works properly and to prevent it from radiating radio frequency noise, it must be connected to the earth ground.

3.5 Power Supply and Wiring

H-T60 must use the power supply with 24 V DC and the power consumption is 20W.

Warning:

To avoid an electrical shock, be sure to switch off the power before connecting the communication/download cable to the operator terminal.

Perform the following steps to wire the power connector:

1. Unplug the power connector and unscrew the screws.
2. Strip approximately 7-8 mm of insulation. Insert the wire all the way into the power connector and then turn the screws tight.
3. Plug in the connector to the power input of the operator terminal.

Note:

The power connector is already plugged into the power input of operator terminal when the package is first opened.

Use copper conductors only, 60/75 °C.

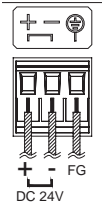

Type	Wire Gauge (AWG)	Stripped Length	Torque
Solid	28-12	7-8 mm	4.5 lb-in
Stranded	30-12	7-8 mm	4.5 lb-in

4 Dip Switches

Dip switch	Function
SW1	Reserved
SW2	Reserved
SW3 SW4	Operation Mode
ON ON	Runs user application
ON OFF	Runs burn-in test program
OFF ON	Updates BIOS
OFF OFF	Runs bench test program
SW5	Communication Parameters
ON	The operator terminal uses the communication parameters defined on the operator terminal's configuration screen for controller communication.
OFF	The operator terminal uses the communication parameters defined in H-Designer for controller communication.
SW6	Password
ON	The operator terminal asks the operator to enter a password after power-on self-test.
OFF	No password is required to start the operator terminal.
SW7	System Menu
ON	The operator terminal displays the system menu.
OFF	The operator terminal runs user application without displaying the system menu.
SW8	Default User Level
ON	The default user level is set to 1 if the operator terminal requires no password to start its operation.
OFF	The default user level is set to 9 if the operator terminal requires no password to start its operation.
SW9	Reserved
SW10	COM2 Port
ON	For RS485, this switch has to be set ON.
OFF	For RS422, this switch has to be set OFF.

5 Communication Ports

COM1, a 9-pin female connector, is used to connect the operator terminal to a controller via RS232 or RS485.

COM2, a 25-pin female connector, is used to connect the operator terminal to a controller via RS232, RS422 or RS485.

Note:

Make sure that the connection is in accordance with the setting of the dip switches, for example RS485 corresponds to SW10 = ON. See section [4 Dip Switches](#).

COM 1

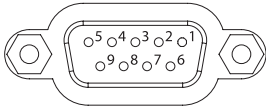

Pin	Function
1	RS485+
2	RS232 RXD
3	RS232 TXD
4	N/A
5	Signal ground
6	RS485-
7	RS232 RTS
8	RS232 CTS
9	Optional; +5V@100mA output

COM 2

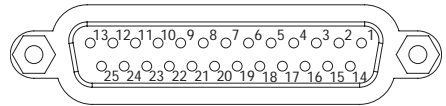

Pin	Function	Pin	Function
1	N/A	14	RS422 TX+ (RS485+)
2	RS232 TXD	15	RS422 TX- (RS485-)
3	RS232 RXD	16	RS422 RX+
4	RS232 RTS	17	RS422 RX-
5	RS232 CTS	18	N/A
6	N/A	19	
7	Signal ground	20	
8	Optional; +5V@100mA output	21	
9	N/A	22	
10		23	RS422 RTS+
11		24	RS422 RTS-
12	RS422 CTS+	25	N/A
13	RS422 CTS-		

6 LCD Contrast Adjustment

Only available for H-T60b-S, H-T60b-Pe and H-T60b-Ne.

The LCD contrast can be adjusted via the touch screen using the system menu command F4 - Set, and performing the following steps:

1. Touch the upper-left and lower-right corners of the screen.
2. Follow the route on the screen.
3. Touch the square on the center of the screen to complete the task.

Note:

When using the F4 -Set command all RAM data will be cleared.

See also section [7.2 System Menu](#).

7 Operation

7.1 Self Test

Once the operator terminal is turned on, it will automatically execute a self-test to check its hardware. The results of the self-test will be displayed on the screen according to the following picture.

```

Human Machine Interface
ROM BIOS Version 1.6
(C) 2006 Beijer Electronics AB
-----
Display Type = Mono STN LCD
System RAM Size ..... 256K Bytes
Video RAM Size ..... 256K Bytes
Battery Backed RAM Size ... 512K Bytes
Application Memory Size ... 4M Bytes
Working RAM Test ..... Passed
Battery Status ..... Passed
BIOS ROM Checksum ..... Passed
Firmware Checksum ..... Passed
Application Checksum ..... Passed
RTC Function Test ..... Passed
Parameter Checksum ..... Passed
Communication Port 1 Test .. Passed
Communication Port 2 Test .. Passed
DIP Switches Setting(8..1)= 11011111

```

If any of tests does not pass the self-test, it will be noted with “Failed” next to the test item. Additionally, the message “Error! Press screen to continue” will be displayed at the bottom of the screen.

If the power to the operator terminal or the PC was interrupted while downloading, **Firmware checksum** or **Application checksum** will not pass the self-test, indicated by “Failed” in the self-test results after power is restored. If this happens, the user can simply follow the download procedure to re-download the application or data. After downloading again, all items should pass the self-test.

Note:

When using the operator terminal for the first time, remember to reset the real time clock (RTC).

7.2 System Menu

Set the dip switch SW7 = ON. After the self-test, the system menu of the operator terminal is displayed on the screen:

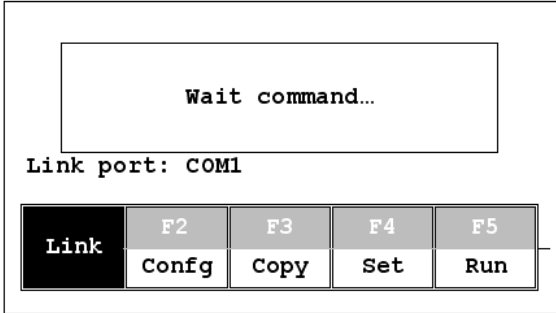

The functions of the commands are briefly explained below:

System menu command	Function
Link	The operator terminal is connected.
F2 - Config	Sets up the internal time clock and communication parameters in the operator terminal. All the settings has to be made for the operator terminal to work properly. Use ↑, ↓, ← and → to move to desired field; + and - to set the value of the field.
F3 - Copy	Copies application data to another H-T60.
F4 - Set	Adjusts touch panel LCD contrast and clears data RAM. See also section 6 LCD Contrast Adjustment . Note: The contrast of the H-T60t models cannot be adjusted.
F5 - Run	Runs the application.

7.3 Key Pad

The six keys on the H-T60 include one menu key and five functional keys (F1-F5), described below. Press the menu key to slide out the innovative slide-out menu.

The functional keys can also be defined in H-Designer and used as “Quick-buttons”, for example, to set an ON/OFF value, to change a screen etc. For further information about the slide-out menu, please see the H-Designer User’s Manual.

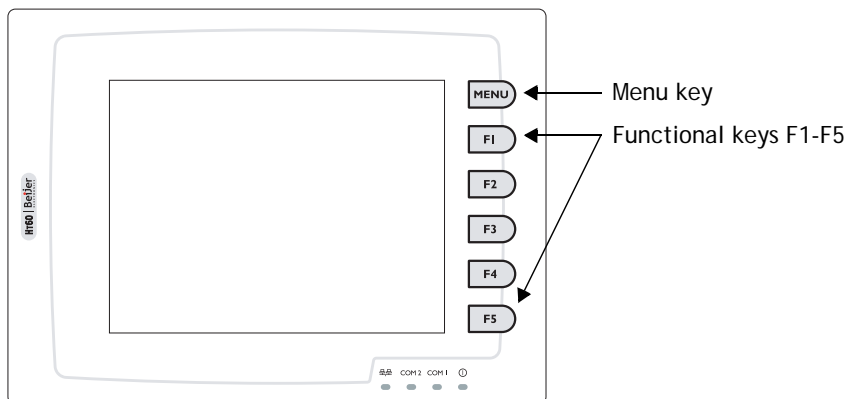

When a key is pressed, the operator terminal will make a “beep” sound to signal that a command is pressed. The default setting, a 200 ms beep, can be configured in H-Designer.

7.4 Bench and Function Tests

Set dip switches SW3 and SW4 = OFF to be able to run the bench and function tests for the H-T60. Turn on the operator terminal to display the following screen:



The bench test performs an overall hardware test, and the function test lets the user select which item to be tested.

Note:

The bench test will clear the application data of the operator terminal.

7.5 Setting Parameters

There are two ways to configure working parameters; to set parameters in the operator terminal or in H-Designer.

To set parameters in the operator terminal, select **F2 - Config** in the system menu.

Note:

Remember to set dip switch SW5 = ON if parameters are set in the operator terminal.

To set parameters in H-Designer, select **Application/Workstation Setup**. Select the **Connection** tab to set communication parameters.

Note:

Remember to set dip switch SW5 = OFF if parameters are set in H-Designer.

7.6 Downloading an Application

Connect the RS232 port on the PC to the COM1 port on the H-T60 using a WPC-P8-42 cable, or to the COM2 port using a WPC-P8-41 cable.

The connection can also be made according to the illustration below, where the left-hand illustration applies to COM1, and the right-hand one to COM2:

9-pin male	9-pin female	25-pin male	9-pin female
RXD 2	2 RD	TXD 2	2 RD
TXD 3	3 SD	RXD 3	3 SD
GND 5	5 SG	GND 7	5 SG
RTS 7	1 CD	RTS 4	1 CD
CTS 8	4 DTR	CTS 5	4 DTR
	6 DSR		6 DSR
	7 RTS		7 RTS
	8 CTS		8 CTS

Warning:

To avoid an electrical shock, be sure to switch off the power before connecting the download cable to the operator terminal.

Set the dip switch **SW7 = ON**. After the self-test, the system menu will be displayed on the screen and the operator terminal is ready to download the application.

Start H-Designer and open the application file to be downloaded. Make sure that the communication parameters are correctly configured. Also remember to compile the file before downloading it. The file has to be compiled every time a change has been made in the file before downloading it.

Then select **Application/Download Firmware/Application** in H-Designer if it is a first time to download the application to the operator terminal; otherwise, select **Application/Download Application**. The following appears on the screen while the operator terminal is downloading:

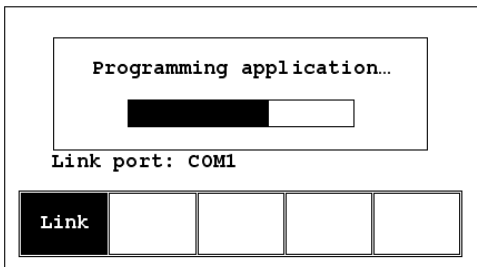

7.7 Uploading an Application

An application can also be uploaded from the operator terminal to the PC. Thus, a user can save an application as a *.V6F file in H-Designer for future use.

Warning:

To avoid an electrical shock, be sure to switch off the power before connecting the communication cable to the operator terminal.

Make sure that the operator terminal and the PC are connected according to section [7.6 Downloading an Application](#). Set the dip switch SW7 = ON. After the self-test, the system menu will be displayed on the screen and the operator terminal is ready to upload the application.

Also make sure that communication parameters are correctly configured. Select **File/Upload Application** in H-Designer and the **Save As** dialog box will appear on the screen. Enter the name of a firmware file (*.AF6) to save. Click **Save**. Then the operator terminal will prompt for a password: enter the password set in H-Designer from **Application/Workstation Setup**. Once the correct password is entered, the operator terminal starts to upload the application to the PC. For information about setting a password, please see section [7.10 Passwords](#).

While the operator terminal is uploading, the following is displayed:

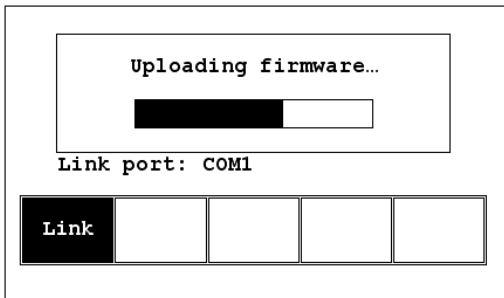

After uploading, select **File/Reconstruct Source** in H-Designer to display the **Open** dialog. Open the uploaded application file (*.C64 or *.AA6). The application screen will be displayed on the PC monitor. Finally, select **File/Save As** to save the application as a *.V6F file. Thus a source file can serve the purposes of maintenance and modification.

Note:

When uploading for the first time, make sure to first run the application once, or else the upload function will not work.

7.8 Uploading/Downloading a Recipe

Set the dip switch SW7 = ON. After the self-test, the system menu will be displayed on the screen and the operator terminal is ready to upload/download a recipe.

Uploading a Recipe

Select **File/Upload Recipes** in H-Designer and the **Save As** dialog box will appear on the screen. Enter the name of a recipe file (*.RCP) to save. Click **Save**. While the operator terminal is uploading the recipe, **Uploading recipes** is displayed on the screen.

Downloading a Recipe

Open an application file with the recipe to be downloaded in H-Designer. Select **File/Download Recipes** to display the **Open** dialog. Enter the name of the recipe file (*.RCP) and click **Open**. While the operator terminal is downloading the recipe, **Downloading recipes** is displayed on the screen.:

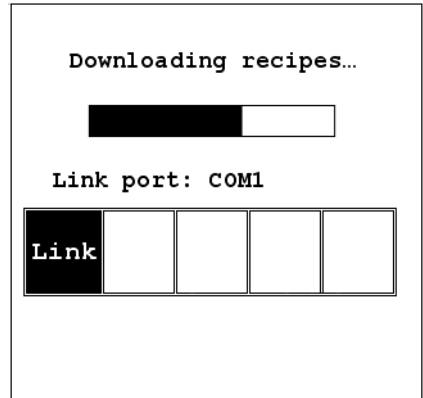
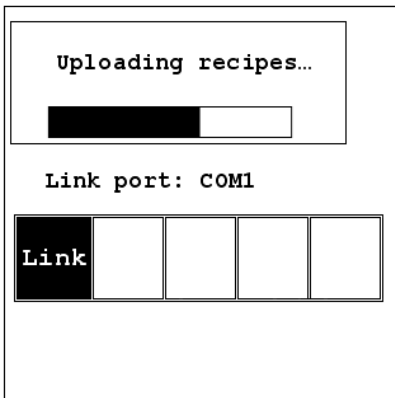

After the download is finished, select **F5 - Run** to run the application.

Remember to define the length and the number of recipes in the application. Also remember to upload the format of recipes from the operator terminal before starting to edit a **new** set of recipe data in the PC.

For further information about creating/editing recipes, please see the corresponding chapter in the H-Designer User's Manual.

7.9 Copying an Application

To copy an application from one H-T60 to another H-T60, select **F3 - Copy** from the system menu. Set the dip switch **SW7 = ON** and connect the two operator terminals with a download cable. After the self-test, the system menu will be displayed on the screen.

Select **F3 - Copy** in the system menu from the operator terminal with the application to be copied. The operator terminal will prompt for a password: enter the password set in H-Designer from **Application/Workstation Setup**. Once the correct password is entered, the H-T60 starts to copy the application to the other H-T60.

For information about setting a password, please see section [7.10 Passwords](#).

The following appears on the screens during the copying:

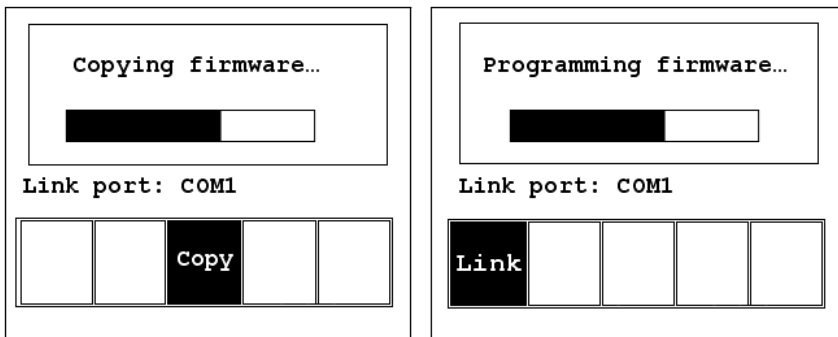

Note:

When copying for the first time, make sure to first run the application once, or else the copy function will not work.

7.10 Passwords

Scenario 1: Requiring a password to start the operator terminal

If the dip switch **SW6 = ON**, the user needs to enter a password to start the operator terminal. For this purpose, the designer can use the object **Action Button** in H-Designer to create a button which displays the password table on the operator terminal display. A user with the right to access the table can register passwords and user levels in the table, shown below.

#	Password	Lv1	
1	00000000	1	
2	00000000	1	F1:
3	00000000	1	CANCEL
4	00000000	1	
5	00000000	1	
6	00000000	1	F2:
7	00000000	1	OK
8	00000000	1	

In the illustration below, the **TBL** button is an action button used to display the password table. When the button is selected the password table is displayed on the screen for a user with the right to access the table.

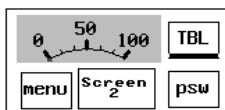

How to configure an **Action Button** is described in the H-Designer User's Manual.

After registering passwords and user levels, set the dip switch **SW6 = ON** (i.e. password required). Restart the operator terminal and after the self-test the user will be prompted to enter a password in order to run the operator terminal.

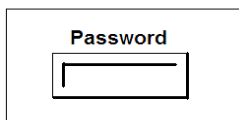

The operator terminal will determine the user level from the entered password. For instance, if the level of the password entered by the user is 1, then the operator terminal will set the user level to 1; if the level of the password entered by the user is 2, then the operator terminal will set the user level to 2. **User level 1** has the highest privilege and **User level 9** has the lowest.

Note:

Only users of **User Level 1** has the right of access to the password table.

Scenario 2: Re-entering a password

The object **Action Button** in H-Designer also allows the designer to create a button which asks the user to re-enter a password.

For example, by pressing the  button the password keypad will be displayed to prompt the user to enter a password. After entering the password, the operator terminal will update the user level according to the most recent password which has been entered. Therefore, this button can be applied to raise or drop one's privileges while the operator terminal is in operation.



How to configure an **Action Button** is described in the H-Designer User's Manual.

Scenario 3: Password-protecting a button in the operator terminal

The designer can create a button which is protected by a password for execution. For example, a **Goto Screen** button can be designed with a high level of security; which means that a password with a high level of privilege is required in order to open the other screen. As the button is selected and the current user has a lower privilege than has been set for the button, the operator terminal will prompt the user for a password. The user will need a password with at least the level of privilege that has been set for the button. This function can restrict users to access to certain parts of the application.

Scenario 4: Requiring a password to copy or upload application

When selecting **F3 - Copy** in the system menu or **File/Upload Application** in H-Designer, the operator terminal will prompt for a password. The user will need to enter the correct password to copy an application from one H-T60 to another. Note that setting this password is different from the passwords set in Scenarios 1-3. To set this password, select **Application/Workstation Setup** in H-Designer. Under the **Password** tab, the designer is able to set the password.

Beijer

ELECTRONICS

Head Office

Sweden

Beijer Electronics Products AB
Box 426
201 24 Malmö, SWEDEN
Tel: +46 40 35 86 00
Fax: +46 40 93 23 01
info@beijerelectronics.com

Subsidiaries

Germany

Elektronik-Systeme Lauer GmbH & Co. KG
Kelterstraße 59
72669 Unterensingen, GERMANY
Tel.: +49 70 22/96 60-101
Fax: +49 70 22/96 60-103
info@systeme-lauer.de

USA

Beijer Electronics Inc.
939 N. Plum Grove Road, Suite F
Schaumburg, IL 601 73, USA
Tel: +1 847 619 6068
Fax: +1 847 619 6674
info.usa@beijerelectronics.com

China

Beijer Electronics Co. Ltd
Room 201, Building B, No. 1618,
Yishan Road, Shanghai 201103, CHINA
Tel: +86 21 6145 0400
Fax: +86 21 6145 0499
Info@beijerelectronics.cn

Taiwan

Hitech Electronics Corp.
7 & 8 F, No. 108 Min-Quan Road
Shin-Tien, Taipei Shien, TAIWAN,
R.O.C. 231
Tel: +886-2-2218-3600
Fax: +886-2-2218-9547
hmi@hitech-lcd.com.tw