

Kramer Electronics, Ltd.



USER MANUAL

BoardView™ Models:

Kit 2V: TP-107V (2 units) and TP-120

Kit 2AV: TP-107AV (2 units) and TP-122

Kit 4V: TP-107V (4 units) and TP-120

Kit 4AV: TP-107AV (4 units) and TP-122

Kit 8V: TP-107V (8 units) and TP-120

Kit 8AV: TP-107AV (8 units) and TP-122

RC-108, *Presentation Controller*

RC-116, *Presentation Controller*

Contents

1	Introduction	1
1.1	The C-STP+KNET-6 Cable	2
2	Getting Started	2
2.1	Quick Start	2
3	Overview	4
3.1	About the TP-107V / TP-120 BoardView™ Kits	4
3.2	About the TP-107AV / TP-122 Kits	6
3.3	Controlling via the RC-108 and RC-116 Presentation Controllers	7
3.4	Recommendations for Achieving the Best Performance	7
4	Your Line Transmitters and Presentation Controllers	8
4.1	Your TP-107V and TP-107AV Line Transmitters	8
4.2	Your TP-120/TP-122 Line Receiver	10
4.2.1	Your TP-120 XGA Line Receiver	10
4.2.2	Your TP-122 XGA / Audio Line Receiver	12
4.3	Your RC-108 / RC-116 Presentation Controller	13
5	Configuring a TP-107V / TP-107AV System	16
5.1	Connecting the TP-107V / TP-107AV	16
5.2	Configuring the TP-107AV / TP-122 Kit with the RC-108	17
5.2.1	Connecting the RC-108 to the TP-107AV / TP-122 Kit	18
5.3	Wiring the CAT 5 LINE IN / LINE OUT RJ-45 Connectors	19
5.4	Connecting the RS-232 Port	19
5.5	Connecting via the RS-485	20
5.6	Setting the Dipswitches of the TP-107AV	20
6	Flash Memory Upgrade	21
6.1	Downloading from the Internet	21
6.2	Connecting the PC to the RS-232 Port	22
6.3	Upgrading Firmware	22
7	Technical Specifications	27

Figures

Figure 1:	TP-107V / TP-120 Kit	5
Figure 2:	TP-107V XGA Line Transmitter	8
Figure 3:	TP-107AV XGA / Audio Line Transmitter	8
Figure 4:	TP-107V / TP-107AV Underside Panel reference	9
Figure 5:	TP-120 XGA Line Receiver	10
Figure 6:	TP-120 XGA Line Receiver (Underside)	11
Figure 7:	TP-122 XGA / Audio Line Receiver	12
Figure 8:	TP-122 XGA / Audio Line Receiver (Underside)	13
Figure 9:	RC-108 Presentation Controller	13

Figure 10: RC-116 Presentation Controller	14
Figure 11: RC-108 Underside Panel	14
Figure 12: RC-116 Underside Panel	15
Figure 13: Connecting the TP-107AV	17
Figure 14: Configuring the TP-107AV / TP-122 / RC-108 System	18
Figure 15: CAT 5 PINOUT	19
Figure 16: RS-232 PINOUT Connection	19
Figure 17: Wiring the RS-485 Connector	20
Figure 18: Dipswitch Settings	20
Figure 19: Splash Screen	22
Figure 20: Atmel – Flip Window	23
Figure 21: Device Selection Window	23
Figure 22: Device Selection Window	24
Figure 23: Loading the Hex	24
Figure 24: RS-232 Window	25
Figure 25: Atmel – Flip Window (Connected)	25
Figure 26: Atmel – Flip Window (Operation Completed)	26

Tables

Table 1: Board View Package Options	1
Table 2: Adding Units to a System	2
Table 3: TP-107V / TP-107AV (Top Panel) Features	9
Table 4: TP-107V / TP-107AV (Underside Panel) Features	10
Table 5: TP-120 XGA Line Receiver Features	11
Table 6: TP-120 XGA Line Receiver (Underside) Features	11
Table 7: TP-122 XGA / Audio Line Receiver Features	12
Table 8: TP-122 XGA / Audio Line Receiver (Underside) Features	13
Table 9: RC-108/RC-116 Presentation Controller Features	14
Table 10: RC-108 / RC-116 (Underside Panel) Features	15
Table 11: CAT 5 PINOUT	19
Table 12: RS-232 PINOUT Connection	19
Table 13: Dipswitch Setting Features	20
Table 14: Machine Number Settings	21
Table 15: Technical Specifications of the TP-107V	27
Table 16: Technical Specifications of the TP-107AV	27
Table 17: Technical Specifications of the RC-108 / RC-116	27

1 Introduction

Welcome to Kramer Electronics! Since 1981, Kramer Electronics has been providing a world of unique, creative, and affordable solutions to the vast range of problems that confront the video, audio, presentation, and broadcasting professional on a daily basis. In recent years, we have redesigned and upgraded most of our line, making the best even better! Our 1,000-plus different models now appear in 11 groups¹ that are clearly defined by function.

Congratulations on purchasing your Kramer *BoardView*TM kit, which is ideal for:

- Presentation and multimedia applications
- Long range graphics distribution for schools, hospitals, laboratories, security, and stores

This user manual² is supplied with each kit (see Table 1) and each individual unit (see Table 2).

Table 1: Board View Package Options

BroadView Kit Name	Machines Included	Combined STP CAT 5 and K-NET ³ Cables ⁴ Provided	Power Adapter Provided (12V DC) ⁵	Recommended Controller
2V	Two TP-107V One TP-120	1	1.25A	N/A
2AV	Two TP-107AV One TP-122	1	1.25A	N/A
4V	Four TP-107V One TP-120	3	2.1A	RC-108
4AV	Four TP-107AV One TP-122	3	2.1A	RC-108
8V	Eight TP-107V One TP-120	7	5A	RC-116
8AV	Eight TP-107AV One TP-122	7	5A	RC-116

You can also purchase additional single units to add to the system, as defined in Table 2:

1 GROUP 1: Distribution Amplifiers; GROUP 2: Switchers and Matrix Switchers; GROUP 3: Control Systems; GROUP 4: Format/Standards Converters; GROUP 5: Twisted-Pair Solutions; GROUP 6: Specialty AV Products; GROUP 7: Scan Converters and Scalers; GROUP 8: Cables and Connectors; GROUP 9: Room Connectivity; GROUP 10: Accessories and Rack Adapters; GROUP 11: Sierra Products

2 Download up-to-date Kramer user manuals from the Internet at this URL: <http://www.kramerelectronics.com>

3 K-NET is a proprietary Kramer protocol for interconnecting Kramer units

4 See section 1.1

5 Adding additional single units to a kit will probably change the power requirements

Table 2: Adding Units to a System

The unit	Cables Provided
TP-107V	One Combined K-NET and CAT 5 Cable ¹
TP-107AV	One Combined K-NET and CAT 5 Cable ¹
RC-108	One K-NET cable
RC-116	One K-NET cable

1.1 The C-STP+KNET-6 Cable

The C-STP+KNET-6 cable provided with the BoardView kits is a combined STP CAT 5 and K-NET cable, which can be separated by carefully tearing it along the cable lines.

2 Getting Started

We recommend that you:

- Unpack the equipment carefully and save the original box and packaging materials for possible future shipment
- Review the contents of this user manual
- Use Kramer high performance high resolution cables²

2.1 Quick Start

This quick start chart summarizes the basic setup and operation steps.

¹ C-STP+KNET-6

² The complete list of Kramer cables is on our Web site at <http://www.kramerelectronics.com>

Step 1: Connect the system - see section 5

Connect the:

- 1 RS-485 ports.
- 2 CAT 5 IN ports.
- 3 CAT 5 OUT ports.
- 4 Inputs on the TP-107AV units.
- 5 Audio and video outputs

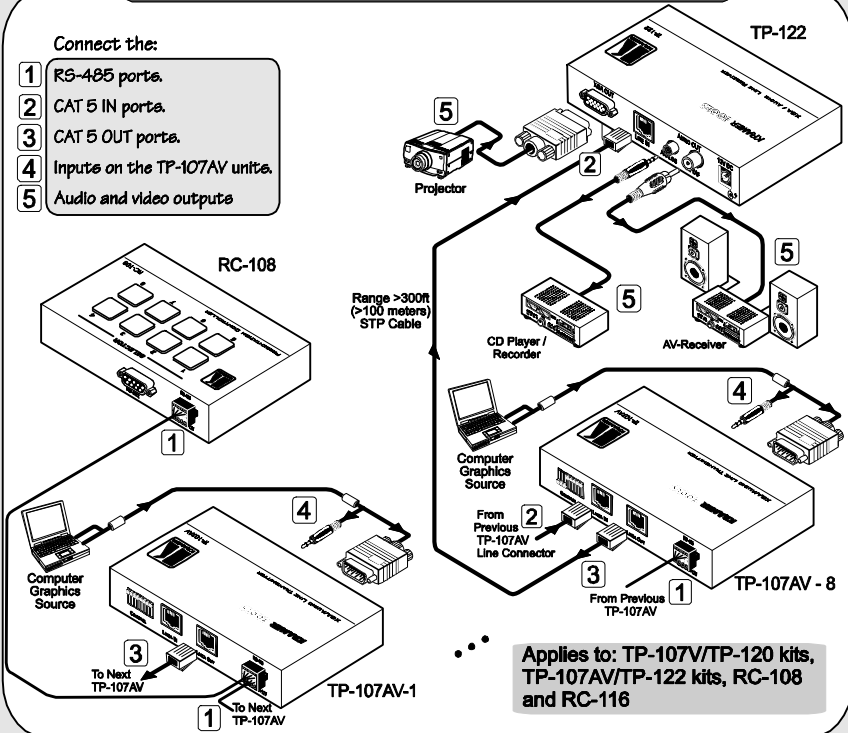

Applies to: TP-107V/TP-120 kits,
TP-107AV/TP-122 kits, RC-108
and RC-116

Set the Dipswitches on the TP-107AV / TP-107V

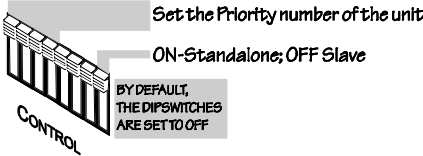

Set the underside switches

TP-107AV/TP-107AV ID BIT, SYNC POLARITY, RS-232 (RS-485), RS-485 TERM.

RC-108/RC-116 NULL MODEM MODE , RS-485 TERM.

Step 2: Connect the power

Step 3: Operation

Press a SELECTOR button on the RC-108/RC-116 Presentation Controller to grant priority to a TP-107AV/TP-107V unit

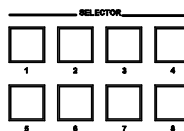

3 Overview

This section describes:

- The **TP-107V / TP-120 BoardView™** kits, see section 3.1
- The **TP-107AV / TP-122 BoardView™** kits, see section 3.2
- The **RC-108** and the **RC-116**, presentation controllers, see section 3.3
- Recommendations for achieving the best performance, see section 3.4

3.1 About the TP-107V / TP-120 BoardView™ Kits

The **TP-107V** is an *XGA Line Transmitter* that accepts a computer graphics¹ video signal and transmits it over a CAT 5 cable.

The **TP-120** is an *XGA Line Receiver*² that receives a coded CAT 5 signal, decodes it and converts it to an XGA output.

The kits include two, four or eight **TP-107V** machines that can be interconnected (via the combined CAT 5 and K-NET cables, supplied with the kit) and each assigned a priority number³ (in sequence). Pressing an online button on any of the interconnected machines transmits the signal from that machine to the **TP-120** receiver, which is also connected to the system (see Figure 1). The signal is then decoded by the **TP-120** and converted to an XGA output. If the ONLINE button is pressed simultaneously on several machines, the machine with the highest machine number will transmit the signal to the receiver.

The priorities of a **TP-107V / TP-120** system can also be set by the **RC-108** or the **RC-116** presentation controllers⁴ (see section 3.3) that can determine which machine in the chain will have access to the **TP-120**.

¹ The terminology XGA is used throughout this manual, where this implies any RGBHV signal on a 15-pin HD computer graphics video connector having a resolution from VGA up to UXGA

² You can download the Kramer TP-120 user manual at: <http://www.kramerelectronics.com>

³ A machine number

⁴ Depending on the number of interconnected units

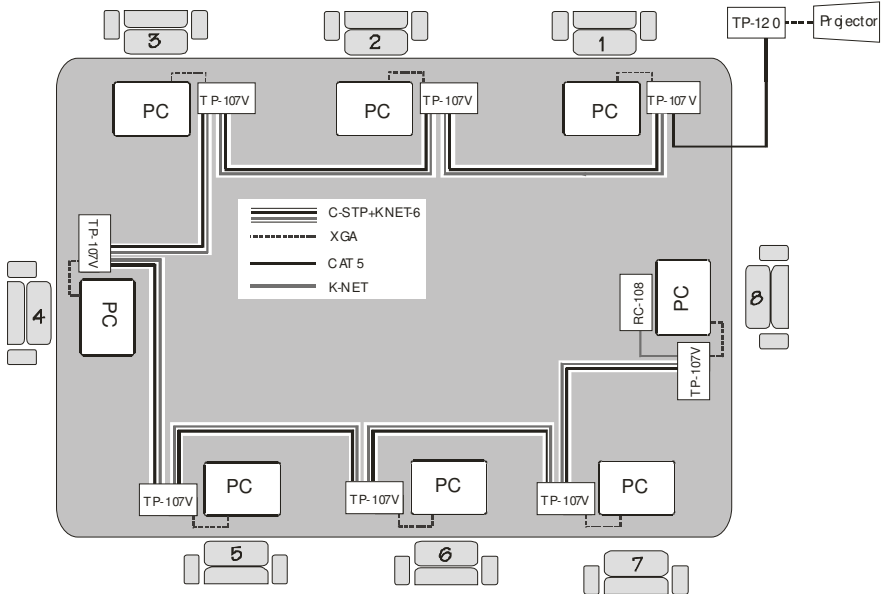

Figure 1: TP-107V / TP-120 Kit

The **TP-107V** includes a:

- LINE IN CAT 5 connector, that connects to the LINE OUT CAT 5 connector on the previous *Line Transmitter*
- LINE OUT CAT 5 connector, that connects to a receiver (for example, the **TP-120**) or to the next *Line Transmitter* in the chain
- CONTROL set of dipswitches

In addition, the **TP-107V**:

- Can be controlled via RS-485
- Has a resolution of up to UXGA
- Can change the polarity of decoding H and V Sync for video
- Can be upgraded via RS-232 and is 12VDC fed

The **TP-120**:

- Has an operating range of more than 300ft. (more than 100 meters)
- Includes EQ. and level controls
- Has the power connect feature¹ and is 12V DC fed

¹ Powering via the CAT 5 cable from either the receiver or the transmitter is good for 100 meters. Above it, both sides should be fed with power

3.2 About the TP-107AV / TP-122 Kits

The **TP-107AV** is an *XGA / Audio Line Transmitter* that accepts a computer graphics¹ video signal and an analog audio signal and transmits them over a CAT 5 cable.

The **TP-122** is an *XGA / Audio Line Receiver*² that receives the coded CAT 5 signal transmitted by a **TP-107AV**, decodes it and converts it to XGA, stereo analog and S/PDIF digital audio outputs.

The kits can include two, four or eight **TP-107AV** machines that can be interconnected (via the combined CAT 5 and K-NET cables, supplied with the kit) and each assigned a priority number³ (in sequence). Pressing an ONLINE button on any of the interconnected machines transmits the signal from that machine to the **TP-122** receiver, which is also connected to the system (see Figure 1)⁴. The signal is then decoded on the **TP-122** and converted to an XGA output and audio outputs. If the ONLINE button is pressed simultaneously on several machines, the machine with the highest machine number will transmit the signal to the receiver.

The priorities of a **TP-107AV / TP-122** system can also be set by the **RC-108** or the **RC-116** presentation controllers⁵ (see section 3.3) that can determine which machine in the chain will have access to the **TP-122**.

The **TP-107AV** includes a:

- LINE IN CAT 5 connector, that connects to the LINE OUT CAT 5 connector on the previous *Line Transmitter*
- LINE OUT CAT 5 connector, that connects to a receiver (for example, the **TP-122**) or to the next *Line Transmitter* in the chain
- CONTROL set of dials

In addition, the **TP-107AV**:

- Can be controlled via RS-485
- Has a resolution of up to UXGA
- Can change the polarity of decoding H and V Sync for video
- Can be upgraded via RS-232 and is 12V DC fed

1 The terminology XGA is used throughout this manual, where this implies any RGBHV signal on a 15-pin HD computer graphics video connector having a resolution from VGA up to UXGA

2 You can download the Kramer TP-122 user manual at: <http://www.kramerelectronics.com>

3 A machine number

4 Same as the TP-107V / TP-120 kit except for the audio line from the PC to the TP-107AV and speakers that are connected to the TP-122

5 Depending on the number of interconnected units

In addition, the **TP-122**:

- Can power or be powered by the transmitter over the same CAT 5 cable
- Can change the polarity of decoding H and V Sync for video
- Includes EQ. and level controls
- Allows an operation range of more than 300ft. (more than 100 meters) over standard CAT 5 cable
- Is 12V DC fed

3.3 Controlling via the RC-108 and RC-116 Presentation Controllers

The **RC-108** and **RC-116** are presentation controller units designed specifically to control a system¹. Each presentation controller has the appropriate number of input selector buttons², an RS-485 and 12V port and an RS-232 9-pin D-sub port for control and firmware upgrade.

3.4 Recommendations for Achieving the Best Performance

Achieving the best performance means:

- Connecting only good quality connection cables³, thus avoiding interference, deterioration in signal quality due to poor matching, and elevated noise levels (often associated with low quality cables)
- Avoiding interference from neighboring electrical appliances that may adversely influence signal quality, and positioning your Kramer *BoardView Kit* away from moisture, excessive sunlight and dust



Caution – No operator-serviceable parts inside unit.

Warning – Use only the Kramer Electronics input power wall adapter that is provided with this unit⁴.

Warning – Disconnect power and unplug unit from wall before installing or removing device or servicing unit.

1 Up to eight and up to 16 units, respectively

2 Eight and 16 buttons, respectively

3 The combined CAT 5 and K-NET cable: C-STP+KNET-6

4 For example: model number AD2512C, part number 2535-000251

4 Your Line Transmitters and Presentation Controllers

This section describes the:

- **TP-107V** and **TP-107AV** line transmitters (see section 4.1)
- **TP-120** and **TP-122** line receivers (see section 4.2)
- **RC-108** and **RC-116** presentation controllers (see section 4.3)

4.1 Your TP-107V and TP-107AV Line Transmitters

Figure 2 and Figure 3 illustrate the **TP-107V** and the **TP-107AV**, respectively. Table 3 defines the **TP-107V / TP-107AV**:

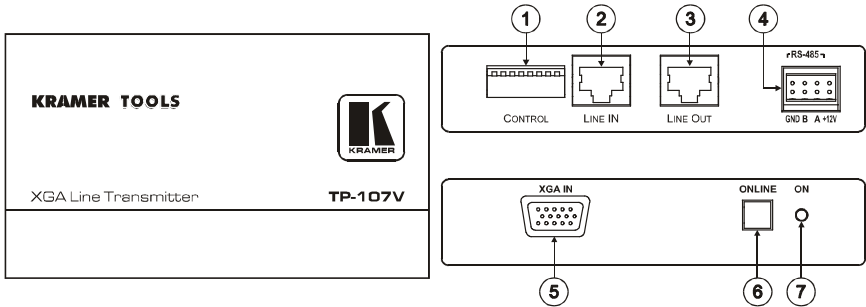

Figure 2: TP-107V XGA Line Transmitter

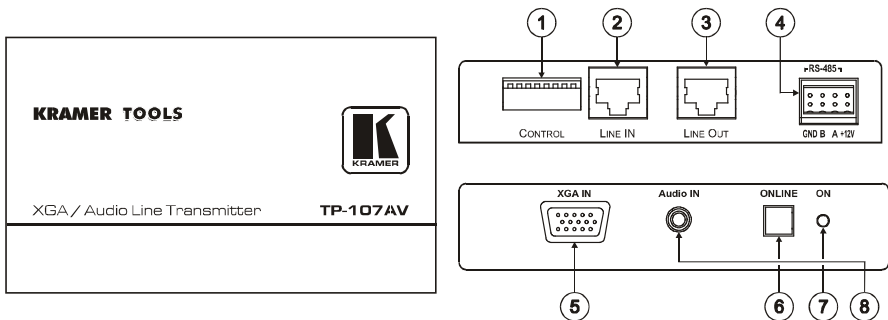

Figure 3: TP-107AV XGA / Audio Line Transmitter

Table 3: TP-107V / TP-107AV (Top Panel) Features

#	Feature	Function
1	CONTROL Dipswitches	DIPs 1, 2, 3 and 4 determine the machine number; DIP 8 sets to standalone or slave mode; DIPs 5, 6 and 7 are reserved
2	LINE IN 1 RJ-45 Connector	Connects to ¹ the LINE OUT RJ-45 connector on the previous line transmitter
3	LINE OUT 2 RJ-45 Connector	Connects to ¹ the LINE IN RJ-45 connector on the receiver ² or the next line transmitter
4	RS-485 and 12V DC PINs	PIN GND is for the Ground connection; PIN B (-) and PIN A (+) are for RS-485 ³ or RS-232 ⁴ , and PIN +12V is for powering the unit ⁵
5	XGA IN 15-pin HD Connector	Connects to the XGA source
6	ONLINE Button	Press to access priority
7	ON LED	Lights when receiving power
8	Audio IN 3.5mm Mini Jack	Connects to the audio source (applies only to the TP-107AV)

Figure 4 and Table 4 define the underside of the TP-107V / TP-107AV:

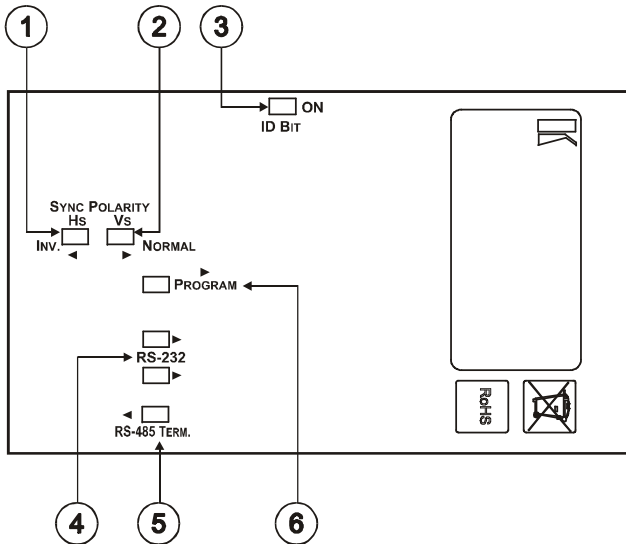

Figure 4: TP-107V / TP-107AV Underside Panel reference

- 1 Using CAT 5 cable with RJ-45 connectors at both ends (the PINOUT is defined in Table 11 and Figure 15)
- 2 For example, the Kramer TP-120 or TP-122. You can download this user manual at: <http://www.kramerelectronics.com>
- 3 Connects to the RS-232 9-pin D-sub port on a Kramer (or other) device or PC (when both RS-232 underside switches are set to the left)
- 4 When both underside RS-232 switches are set to the right
- 5 The 12V DC power supply (provided) is used to power the system (see Table 1)

Table 4: TP-107V / TP-107AV (Underside Panel) Features

#	Feature		Function
1	SYNC POLARITY Switches	HS	Slide the switch to the left to INV. ¹ to change the HS polarity ² Slide the switch to the right to NORMAL to retain the polarity
2		VS	Slide the switch to the left to INV. ¹ to change the VS polarity ² Slide the switch to the right to NORMAL to retain the polarity
3	ID BIT Switch		Slide to the right to ON ³ or to the left to set to OFF
4	RS-232 Switches		Set both switches to the right to convert the RS-485 connectors to RS-232 for firmware upgrade
5	RS-485 TERM. Switch		Set the switch to the left to ON for RS-485 Line Termination with 120Ω
6	PROGRAM Switch		Slide to the right to PROGRAM to upgrade to the latest Kramer firmware (via RS-232), see section 6. Switch to the left for normal operation

4.2 Your TP-120/TP-122 Line Receiver

This section defines the:

- **TP-120 XGA Line Receiver** (see section 4.2.1)
- **TP-122 XGA / Audio Line Receiver** (see section 4.2.2)

4.2.1 Your TP-120 XGA Line Receiver

Figure 5 and Table 5 define the **TP-120 XGA Line Receiver**:

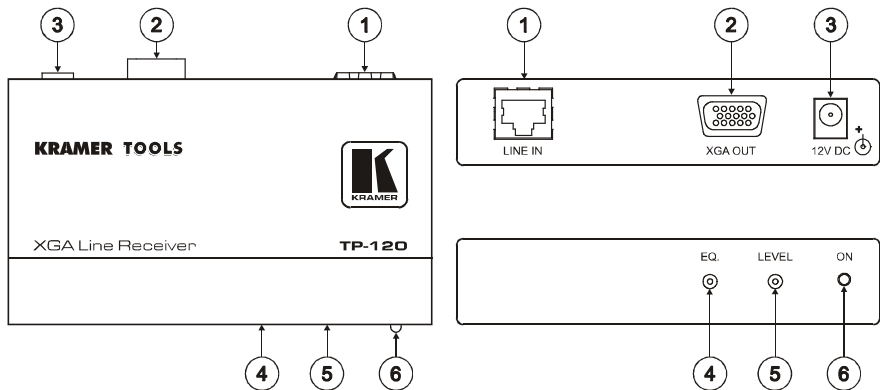

Figure 5: TP-120 XGA Line Receiver

1 By default, both switches are set to the right

2 Downgoing syncs

3 The default. Enabling the notebook or laptop to output a VGA signal to an external VGA monitor

Table 5: TP-120 XGA Line Receiver Features

#	Feature	Function
1	LINE IN RJ-45 Connector	Connects to the LINE OUT RJ-45 connector on the TP-107V
2	XGA OUT HD15F Connector	Connect to the XGA acceptor
3	12V DC	+12V DC connector for powering the unit
4	EQ. ¹ Trimmer	Adjusts ² the cable compensation equalization level
5	LEVEL Trimmer	Adjusts ² the output signal level
6	ON LED	Illuminates when receiving power

Figure 6 and Table 6 define the underside of the TP-120 XGA Line Receiver:

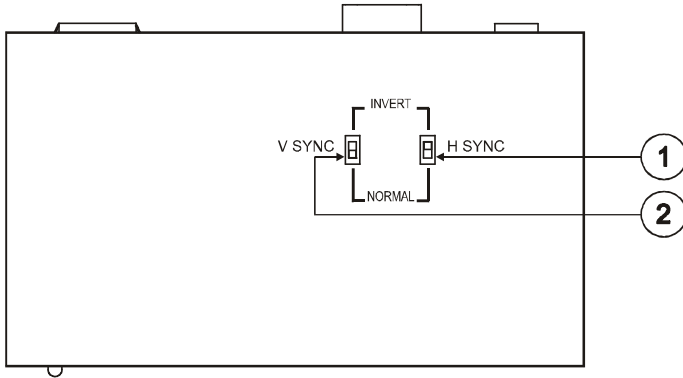

Figure 6: TP-120 XGA Line Receiver (Underside)

Table 6: TP-120 XGA Line Receiver (Underside) Features

#	Feature	Function
1	H SYNC Switch	Slide the switch down to retain the polarity Slide the switch up ³ to change the H SYNC polarity
2	V SYNC Switch	Slide the switch down to retain the polarity Slide the switch up ³ to change the V SYNC polarity

1 Degradation and VGA/XGA signal loss can result from using long cables (due to stray capacitance), sometimes leading to a total loss of sharpness in high-resolution signals

2 Use a screwdriver to carefully rotate the trimmer, adjusting the appropriate level

3 By default, both switches are set down for normal V SYNC and H SYNC polarity

4.2.2 Your TP-122 XGA / Audio Line Receiver

Figure 7 and Table 7 define the **TP-122 XGA / Audio Line Receiver**:

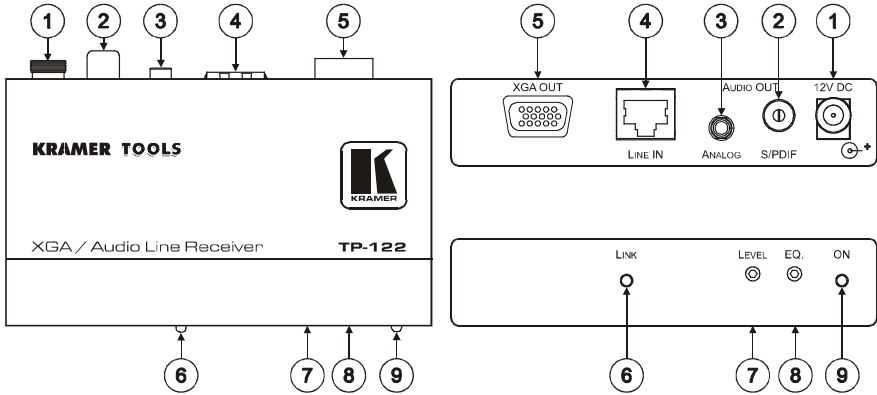

Figure 7: TP-122 XGA / Audio Line Receiver

Table 7: TP-122 XGA / Audio Line Receiver Features

#	Feature	Function
1	12V DC	+12V DC connector for powering the unit
2	AUDIO OUT	S/PDIF RCA connector
3		Connects to the digital audio acceptor
3	ANALOG 3.5mm Mini Jack	Connects to the analog audio acceptor
4	LINE IN RJ-45 Connector	Connects to ¹ the TP-121 or the TP-104 ²
5	XGA OUT HD15F Connector	Connects to the XGA acceptor
6	LINK LED	Illuminates when receiving the correct input signal
7	LEVEL Trimmer	Adjusts ⁴ the output signal level
8	EQ ³ Trimmer	Adjusts ⁴ the cable compensation equalization level
9	ON LED	Illuminates when receiving power

1 Using an STP CAT 5 cable with RJ-45 connectors at both ends (the PINOUT is defined in Table 11 and Figure 15)

2 The TP-104 does not accept the audio signals

3 Degradation and VGA/XGA signal loss can result from using long cables (due to stray capacitance), sometimes leading to a total loss of sharpness in high-resolution signals

4 Use a screwdriver to carefully rotate the trimmer, adjusting the appropriate level

Figure 8 and Table 8 define the underside of the **TP-122 XGA / Audio Line Receiver**:

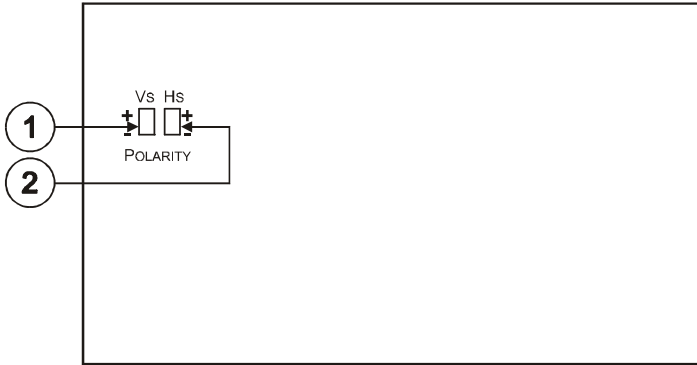

Figure 8: TP-122 XGA / Audio Line Receiver (Underside)

Table 8: TP-122 XGA / Audio Line Receiver (Underside) Features

#	Feature	Function
1	VS Switch	Slide the switch down, to set the V SYNC to negative polarity; slide the switch up ¹ , to set the V SYNC to positive polarity
2	HS Switch	Slide the switch down, to set the H SYNC to negative polarity; slide the switch up ¹ , to set the H SYNC to positive polarity

4.3 Your RC-108 / RC-116 Presentation Controller

Figure 9 and Table 9 define the **RC-108**:

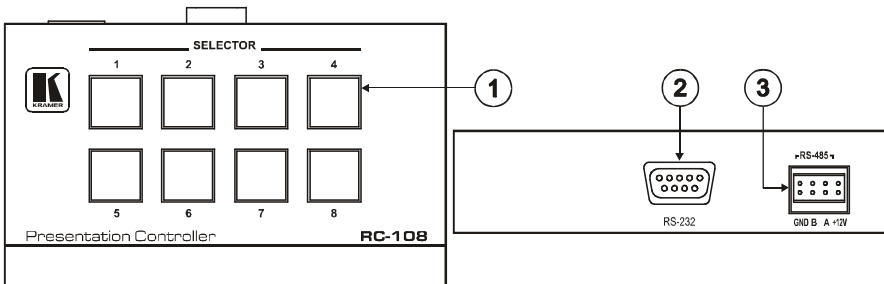

Figure 9: RC-108 Presentation Controller

¹ By default, both switches are set down (for a negative V SYNC and H SYNC polarity)

Figure 10 and Table 9 define the **RC-116**:

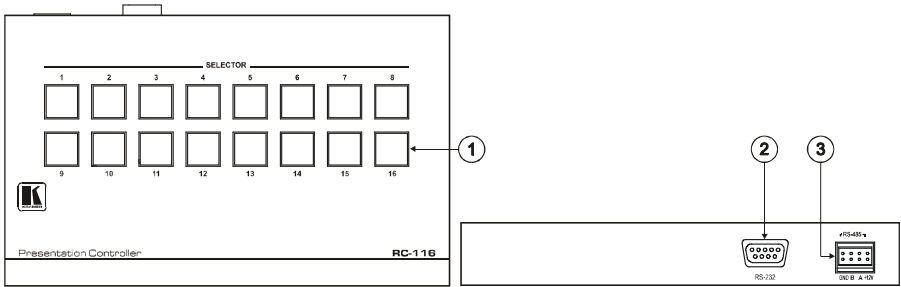

Figure 10: RC-116 Presentation Controller

Table 9: RC-108/RC-116 Presentation Controller Features

#	Feature	Function
1	SELECTOR Button ¹	Press to give priority to a TP-107V/TP-107AV unit, according to its machine number Press and hold ² to toggle between releasing control ³ over the TP-107V / TP-107AV and regaining control
2	RS-232 9-pin D-sub Connector	Connects to a PC or a Remote Controller, and also for upgrading the firmware (see section 6)
3	RS-485 and 12V DC PINs	PIN GND is for the Ground connection; PIN B (-) and PIN A (+) are for RS-485, and PIN +12V is for powering the unit

Figure 11, Figure 12 and Table 10 define the underside of the **RC-108** and the **RC-116**:

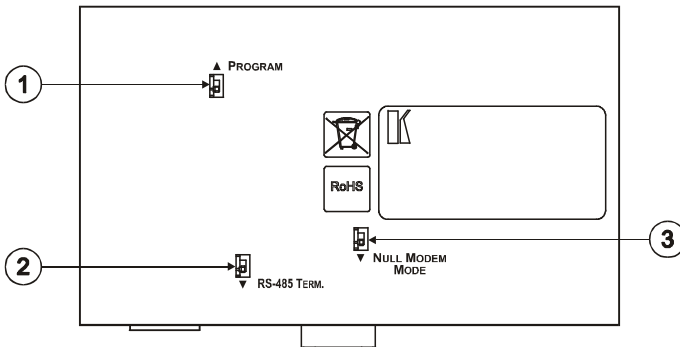

Figure 11: RC-108 Underside Panel

1 From 1 to 8 for the RC-108, and from 1 to 16 for the RC-116

2 For about 2 seconds

3 For example, to let unit 6 gain control, press the selector button 6 (button 6 illuminates). To let unit 7 gain control, press the selector button 7 (button 7 illuminates and button 6 no longer illuminates). To release control over the units, press and hold the selected button (button 7 in this example) until it no longer illuminates

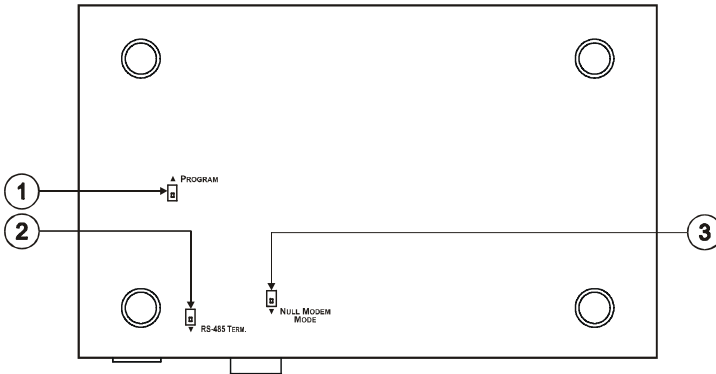

Figure 12: RC-116 Underside Panel

Table 10: RC-108 / RC-116 (Underside Panel) Features

#	Feature	Function
1	PROGRAM Switch	Slide upwards to PROGRAM to upgrade to the latest Kramer firmware (see section 6), slide downwards for normal operation
2	RS-485 TERM. Switch	Set the switch to the left to ON for RS-485 Line Termination with 120Ω
3	NULL MODEM MODE Switch	Set to NULL MODEM MODE to connect a PC to the unit, using the Null-modem adapter; otherwise connect without a null-modem adapter

5 Configuring a TP-107V / TP-107AV System

This section describes how to:

- Connect the **TP-107V / TP-107AV** (see section 5.1)
- Configure a **TP-107AV / TP-122** kit with an **RC-108 / RC-116** controller (see section 5.2)
- Wire the CAT 5 LINE IN / LINE OUT RJ-45 Connectors (see section 5.3)
- Connect a PC (see section 5.4)
- Connect via the RS-485 terminal block connector (see section 5.5)
- Use the dipswitches (see section 5.6)

5.1 Connecting the TP-107V / TP-107AV

To connect the **TP-107AV**¹ as illustrated in the example in Figure 13, do the following:

1. Connect an XGA source (for example, a computer graphics source) to the XGA IN 15-pin HD computer graphics connector and an audio source to the Audio IN 3.5mm mini jack, for example, using a Kramer C-GMA/GMA cable (VGA HD15M +Audio jack to VGA HD15M +Audio jack)².
2. Connect the LINE OUT RJ-45 connector to the LINE IN RJ-45 connector on the next **TP-107AV** in the chain or to the LINE IN RJ-45 connector of a receiver (for example, the Kramer **TP-120**³ for the **TP-107V**, or **TP-122** for the **TP-107AV**), via STP cabling⁴ (with a range of more than 300ft (>100m)).
3. Connect the LINE OUT RJ-45 connector of the previous **TP-107AV** unit to the LINE IN RJ-45 connector on the **TP-107AV**.
4. Connect the RS-485 and +12V⁵ port to the previous and the next **TP-107AV** unit or to the **RC-108** Presentation Controller⁶.

1 From this section on, the TP-107AV applies also to the TP-107V (except for the audio connection) unless stated otherwise

2 Not supplied. The full list of Kramer cables is on our Web site at <http://www.kramerelectronics.com>. Alternatively, you can connect an XGA source to the XGA IN 15-pin HD computer graphics connector, and a separate audio source to the AUDIO IN 3.5mm mini jack

3 Refer to the separate user manual, which can be downloaded at <http://www.kramerelectronics.com>

4 For details of how to wire a CAT 5 LINE IN / LINE OUT RJ-45 connector, see section 5.3

5 The 12V DC power supply (provided) is used to power the system (see Table 1)

6 Or alternatively to the RC-116 (see section 3.3)

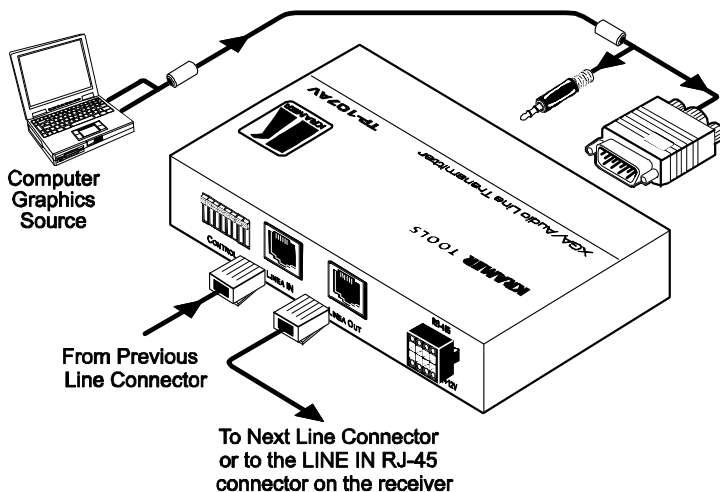

Figure 13: Connecting the TP-107AV

5.2 Configuring the TP-107AV / TP-122 Kit with the RC-108¹

To configure a presentation system as illustrated in the example in Figure 14, do the following:

1. Connect the computer graphics source on each **TP-107AV**² machine in the chain (see section 5.1).
2. Interconnect the **TP-107AV** machines via the C-STP+KNET-6 cables.
3. Connect the **RC-108 Presentation Controller** to the chain via the RS-485 port.
4. Connect the last **TP-107AV** unit to a receiver (for example, the Kramer **TP-122**³), which is connected to an acceptor (for example, a projector and an AV receiver with speakers).
5. Set the RS-485 TERM switch on the first unit to ON.
6. Set a machine number for each machine via the dipswitches (see section 5.6).

¹ From this section on, the RC-108 applies also to the RC-116, unless stated otherwise

² You may connect both types in the same chain

³ Refer to the separate user manual, which can be downloaded at <http://www.kramerelectronics.com>

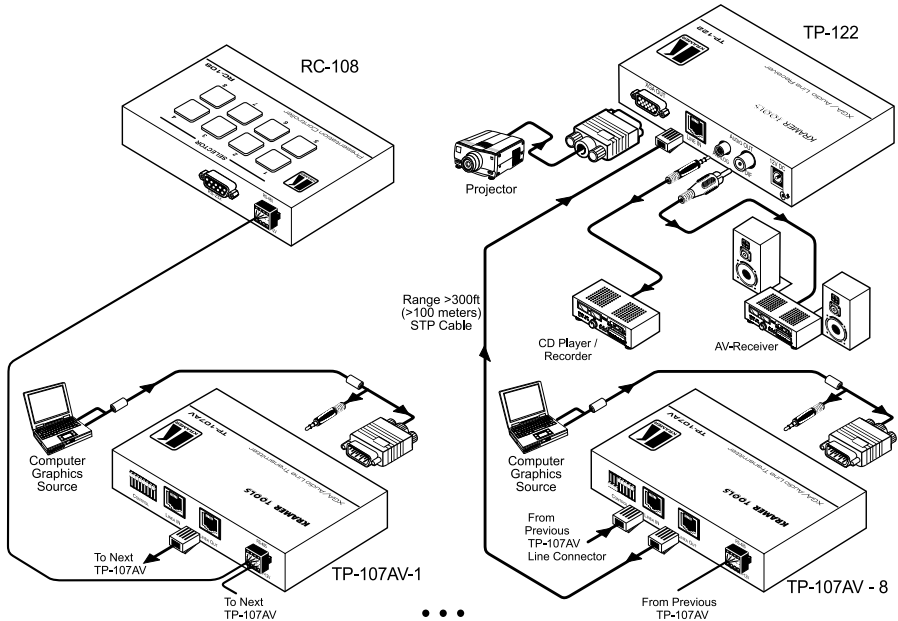

Figure 14: Configuring the TP-107AV / TP-122 / RC-108 System

5.2.1 Connecting the RC-108 to the TP-107AV / TP-122 Kit

The **RC-108** unit, when connected to a chain of **TP-107AV** units, controls the system by granting access to the projector and overriding the individual **ONLINE** buttons on the **TP-107AV** units.

If a **SELECTOR** button on the **RC-108** is pressed and held for about 2 seconds, the **RC-108** loses control over the **TP-107AV** units in the chain. To regain control, press and hold once again.

5.3 Wiring the CAT 5 LINE IN / LINE OUT RJ-45 Connectors

Table 11 and Figure 15 define the STP CAT 5 PINOUT, using a straight pin-to-pin cable with RJ-45 connectors:

Table 11: CAT 5 PINOUT

EIA /TIA 568A		EIA /TIA 568B	
PIN	Wire Color	PIN	Wire Color
1	Green / White	1	Orange / White
2	Green	2	Orange
3	Orange / White	3	Green / White
4	Blue	4	Blue
5	Blue / White	5	Blue / White
6	Orange	6	Green
7	Brown / White	7	Brown / White
8	Brown	8	Brown
Pair 1 4 and 5		Pair 1 4 and 5	
Pair 2 3 and 6		Pair 2 1 and 2	
Pair 3 1 and 2		Pair 3 3 and 6	
Pair 4 7 and 8		Pair 4 7 and 8	

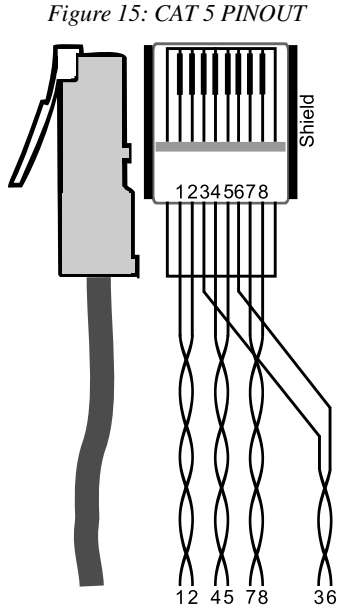

Figure 15: CAT 5 PINOUT

5.4 Connecting the RS-232 Port

The RS-232 9-pin D-sub connector port is defined in Table 12 and Figure 16:

Table 12: RS-232 PINOUT Connection

Connect this PIN on the Terminal Block Connector:	To this PIN on the 9-pin D-sub Connector
Tx	PIN 2
Rx	PIN 3
GND	PIN 5

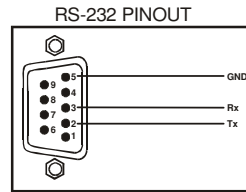

Figure 16: RS-232 PINOUT Connection

5.5 Connecting via the RS-485

You can interconnect the **TP-107AV** units together with an **RC-108/RC-116** controller via RS-485 communication (using the C-STP+KNET-6 cables), as illustrated in Figure 17.

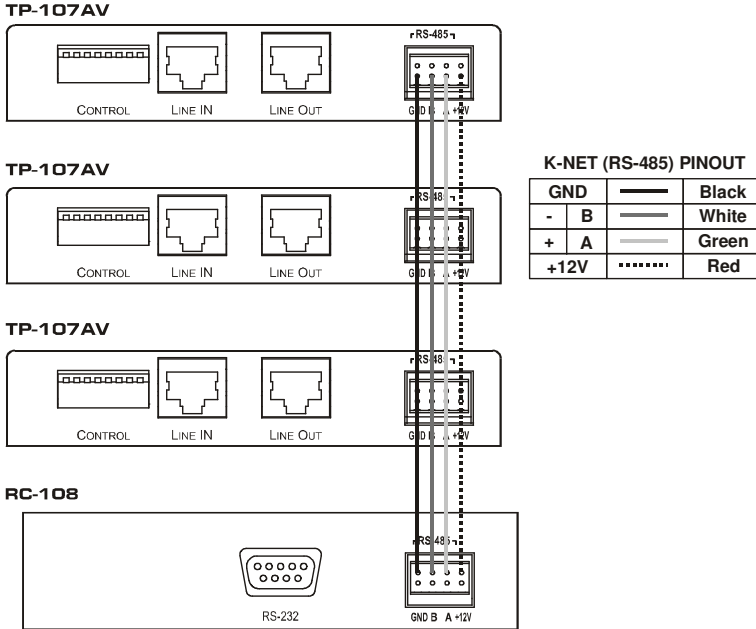

Figure 17: Wiring the RS-485 Connector

5.6 Setting the Dipswitches of the TP-107AV

Figure 18 and Table 13 define the factory default dipswitches:

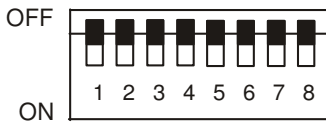

Figure 18: Dipswitch Settings

Table 13: Dipswitch Setting Features

DIPS	Description
1, 2, 3, 4	Set the machine number for each TP-107AV/TP-107V in the chain (see Table 14)
5, 6, 7	Not used
8	Set to ON for a standalone unit Set to OFF when in slave mode

Table 14 defines the Unit number dipswitch setup:

Table 14: Machine Number Settings

Machine #	DIP 1	DIP 2	DIP 3	DIP 4	Machine #	DIP 1	DIP 2	DIP 3	DIP 4
1	OFF	OFF	OFF	OFF	9	OFF	OFF	OFF	ON
2	ON	OFF	OFF	OFF	10	ON	OFF	OFF	ON
3	OFF	ON	OFF	OFF	11	OFF	ON	OFF	ON
4	ON	ON	OFF	OFF	12	ON	ON	OFF	ON
5	OFF	OFF	ON	OFF	13	OFF	OFF	ON	ON
6	ON	OFF	ON	OFF	14	ON	OFF	ON	ON
7	OFF	ON	ON	OFF	15	OFF	ON	ON	ON
8	ON	ON	ON	OFF	16	ON	ON	ON	ON

6 Flash Memory Upgrade

The **TP-107V**¹ firmware is located in FLASH memory, which lets you upgrade² to the latest Kramer firmware version in minutes! The process involves:

- Downloading from the Internet (see section 6.1)
- Connecting the PC to the RS-232 port (see section 6.2)
- Upgrading Firmware (see section 6.3)

6.1 Downloading from the Internet

You can download the up-to-date file³ from the Internet. To do so:

1. Go to our Web site at www.kramerelectronics.com and download the file: “*FLIP_TP107.zip*” from the Technical Support section.
2. Extract the file: “*FLIP_TP107.zip*” to a folder (for example, C:\Program Files\Kramer Flash).
3. Create a shortcut on your desktop to the file: “*FLIP.EXE*”.

¹ This section applies also to TP-107AV, RC-108 and RC-116

² Upgrade should be carried out by skilled technical personnel. Failure to upgrade correctly will result in the malfunction of the machine

³ The files indicated in this section are given as an example only. File names are liable to change from time to time

6.2 Connecting the PC to the RS-232 Port

Before installing the latest Kramer firmware version on a **TP-107V** unit, do the following:

1. Connect the RS-232 9-pin D-sub rear panel port according to section 5.4.
2. Slide the underside PROGRAM switch to ON).
3. Switch the unit ON.

6.3 Upgrading Firmware

Follow these steps to upgrade the firmware:

1. Double click the desktop icon: “*Shortcut to FLIP.EXE*”.
The Splash screen appears as follows:

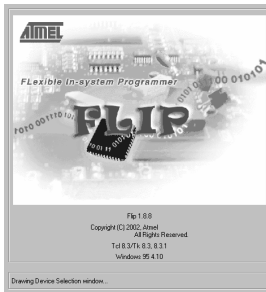

Figure 19: Splash Screen

2. After a few seconds, the Splash screen is replaced by the “*Atmel – Flip*” window:

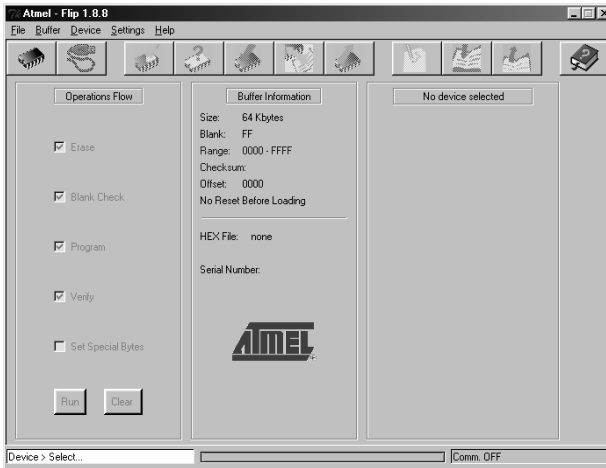

Figure 20: Atmel – Flip Window

3. Press the keyboard shortcut key *F2* (or select the “*Select*” command from the *Device* menu, or press the integrated circuit icon in the upper right corner of the window).
The “*Device Selection*” window appears:

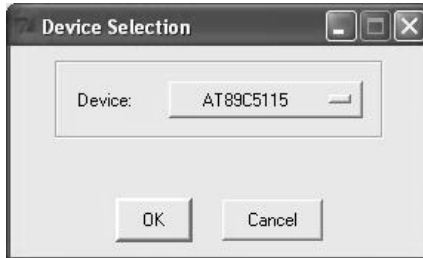

Figure 21: Device Selection Window

4. Click the button next to the name of the device and select from the list:
AT89C51RD2:

Flash Memory Upgrade

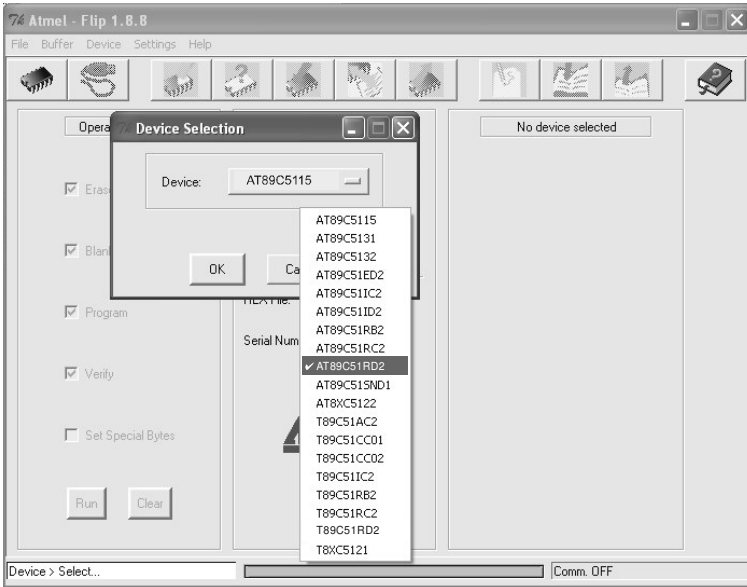

Figure 22: Device Selection Window

5. Click OK and select “Load Hex” from the File menu.

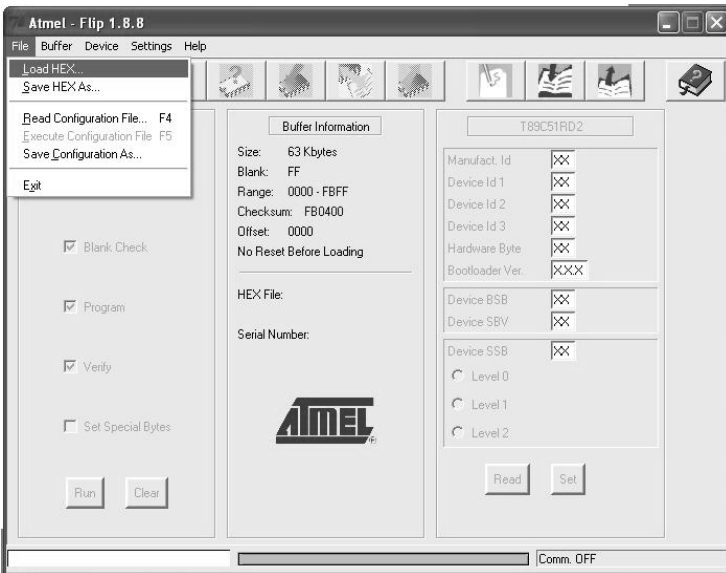

Figure 23: Loading the Hex

6. The Open File window opens. Select the correct HEX file that contains the updated version of the firmware for **TP-107V** (for example **44M_V1p2.hex**) and click Open.
7. Press the keyboard shortcut key *F3* (or select the “*Communication / RS232*” command from the *Settings* menu, or press the keys: *Alt SCR*). The “*RS232*” window appears. Change the COM port according to the configuration of your computer and select the 9600 baud rate:

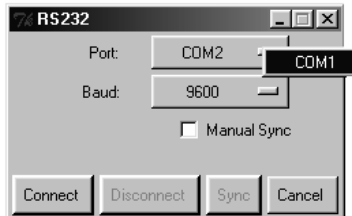

Figure 24: RS-232 Window

8. Click Connect.
In the “*Atmel – Flip*” window, in the *Operations Flow* column, the *Run* button is active, and the name of the chip appears as the name of the third column: *AT89C51RD2*.
Verify that in the *Buffer Information* column, the “*HEX File: TP107.hex*” appears.

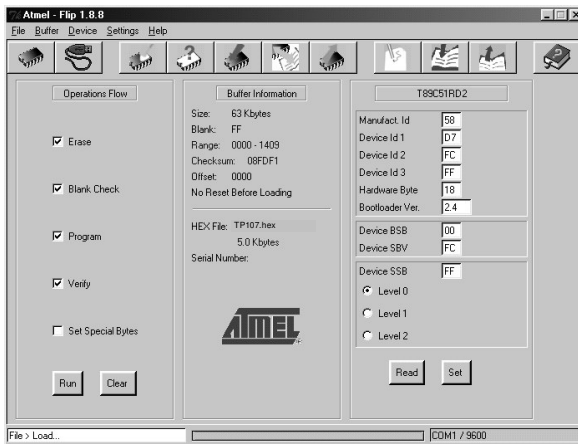

Figure 25: Atmel – Flip Window (Connected)

9. Click *Run*.
After each stage of the operation is completed, the check-box for that

stage becomes colored green¹.

When the operation is completed, all 4 check-boxes will be colored green and the status bar message: *Memory Verify Pass* appears²:

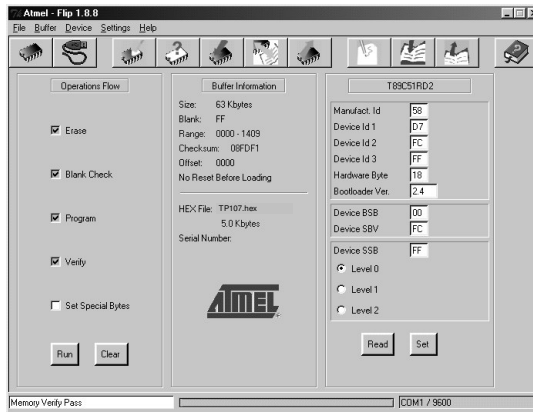

Figure 26: Atmel – Flip Window (Operation Completed)

10. Close the “Atmel – Flip” window.
11. Disconnect the power on the **TP-107V**.
12. If required, disconnect the *RS-232* rear panel port on the **TP-107V** unit from the Null-modem adapter.
13. Slide the underside **PROGRAM** switch to the normal position.
14. Connect the power to the **TP-107V**.

¹ See also the blue progress indicator on the status bar

² If an error message: “Not Finished” shows, click Run again

7 Technical Specifications¹

Table 15, Table 16 and Table 17 define the **TP-107V / TP-107AV / RC-108 / RC-116** technical specifications.

Table 15: Technical Specifications of the TP-107V

INPUT:	1 XGA on a 15-pin HD connector, 1 CAT 5 on an RJ-45 connector (LINE IN)
OUTPUTS:	1 CAT 5 on an RJ-45 connector (LINE OUT)
MAX. OUTPUT LEVEL:	1.5Vpp
HIGHEST RESOLUTION:	UXGA, 1080p
S/N RATIO:	61dB @5MHz
CONTROLS:	Slide switches BIT: ID BIT (PIN 4); horizontal and vertical sync inversion; RS-232, RS-485, RS-485 TERM, PROGRAM
COUPLING:	AC
POWER SOURCE:	See Table 1
DIMENSIONS:	12cm x 6.95cm x 2.44cm (4.7" x 2.74" x 0.96"), W, D, H
WEIGHT:	0.3kg (0.66lbs) approx.
ACCESSORIES:	Power supply, mounting bracket, 19" rack adapters, Combined K-NET and CAT 5 ² cables (see Table 1)

Table 16: Technical Specifications of the TP-107AV

INPUTS:	1 XGA on a 15-pin HD connector, 1 CAT 5 on an RJ-45 connector (LINE IN) 1 stereo on 3.5mm phones	
OUTPUTS:	1 CAT 5 on an RJ-45 connector (LINE OUT)	
MAX. OUTPUT LEVEL:	VIDEO: 1.5Vpp	AUDIO: 1.7Vpp
BANDWIDTH (-3dB):		AUDIO: 21kHz
S/N RATIO:	VIDEO: 61dB @5MHz	AUDIO: 78dB
CROSSTALK (all hostile):	VIDEO: -55.5dB @50MHz, video into audio	
CONTROLS:	Slide switches bit: ID BIT (PIN 4), horizontal and vertical sync inversion; RS-232, RS-485, RS-485 TERM, PROGRAM	
COUPLING:	VIDEO: AC	AUDIO: AC
AUDIO THD + NOISE:	0.1%	
AUDIO 2nd HARMONIC:	0.02%	
POWER SOURCE:	See Table 1	
DIMENSIONS:	12cm x 6.95cm x 2.44cm (4.7" x 2.74" x 0.96"), W, D, H	
WEIGHT:	0.3kg (0.66lbs) approx.	
ACCESSORIES:	Power supply, mounting bracket, 19" rack adapters, K-NET and CAT 5 cables (see Table 1)	

Table 17: Technical Specifications of the RC-108 / RC-116

CONTROLS:	RS-485, RS-232
DIMENSIONS:	RC-108: 12cm x 6.95cm x 2.44cm (4.7" x 2.74" x 0.96"), W, D, H RC-116: 18.4cm x 11.4cm x 2.65cm (7.24" x 4.5" x 1.05"), W, D, H
WEIGHT:	RC-108: 0.3kg (0.66lbs) approx. RC-116: 0.6kg (1.32lbs) approx.

¹ Specifications are subject to change without notice

² C-STP+KNET-6

LIMITED WARRANTY

Kramer Electronics (hereafter *Kramer*) warrants this product free from defects in material and workmanship under the following terms.

HOW LONG IS THE WARRANTY

Labor and parts are warranted for seven years from the date of the first customer purchase.

WHO IS PROTECTED?

Only the first purchase customer may enforce this warranty.

WHAT IS COVERED AND WHAT IS NOT COVERED

Except as below, this warranty covers all defects in material or workmanship in this product. The following are not covered by the warranty:

1. Any product which is not distributed by Kramer, or which is not purchased from an authorized Kramer dealer. If you are uncertain as to whether a dealer is authorized, please contact Kramer at one of the agents listed in the Web site www.kramerelectronics.com.
2. Any product, on which the serial number has been defaced, modified or removed, or on which the WARRANTY VOID IF TAMPERED sticker has been torn, reattached, removed or otherwise interfered with.
3. Damage, deterioration or malfunction resulting from:
 - i) Accident, misuse, abuse, neglect, fire, water, lightning or other acts of nature
 - ii) Product modification, or failure to follow instructions supplied with the product
 - iii) Repair or attempted repair by anyone not authorized by Kramer
 - iv) Any shipment of the product (claims must be presented to the carrier)
 - v) Removal or installation of the product
 - vi) Any other cause, which does not relate to a product defect
 - vii) Cartons, equipment enclosures, cables or accessories used in conjunction with the product

WHAT WE WILL PAY FOR AND WHAT WE WILL NOT PAY FOR

We will pay labor and material expenses for covered items. We will not pay for the following:

1. Removal or installations charges.
2. Costs of initial technical adjustments (set-up), including adjustment of user controls or programming. These costs are the responsibility of the Kramer dealer from whom the product was purchased.
3. Shipping charges.

HOW YOU CAN GET WARRANTY SERVICE

1. To obtain service on you product, you must take or ship it prepaid to any authorized Kramer service center.
2. Whenever warranty service is required, the original dated invoice (or a copy) must be presented as proof of warranty coverage, and should be included in any shipment of the product. Please also include in any mailing a contact name, company, address, and a description of the problem(s).
3. For the name of the nearest Kramer authorized service center, consult your authorized dealer.

LIMITATION OF IMPLIED WARRANTIES

All implied warranties, including warranties of merchantability and fitness for a particular purpose, are limited in duration to the length of this warranty.

EXCLUSION OF DAMAGES

The liability of Kramer for any effective products is limited to the repair or replacement of the product at our option. Kramer shall not be liable for:

1. Damage to other property caused by defects in this product, damages based upon inconvenience, loss of use of the product, loss of time, commercial loss; or:
2. Any other damages, whether incidental, consequential or otherwise. Some countries may not allow limitations on how long an implied warranty lasts and/or do not allow the exclusion or limitation of incidental or consequential damages, so the above limitations and exclusions may not apply to you.

This warranty gives you specific legal rights, and you may also have other rights, which vary from place to place.

NOTE: All products returned to Kramer for service must have prior approval. This may be obtained from your dealer.

This equipment has been tested to determine compliance with the requirements of:

- EN-50081: "Electromagnetic compatibility (EMC);
generic emission standard.
Part 1: Residential, commercial and light industry"
EN-50082: "Electromagnetic compatibility (EMC) generic immunity standard.
Part 1: Residential, commercial and light industry environment".
CFR-47: FCC Rules and Regulations:
Part 15: "Radio frequency devices
Subpart B Unintentional radiators"

CAUTION!

- Servicing the machines can only be done by an authorized Kramer technician. Any user who makes changes or modifications to the unit without the expressed approval of the manufacturer will void user authority to operate the equipment.
- Use the supplied DC power supply to feed power to the machine.
- Please use recommended interconnection cables to connect the machine to other components.



For the latest information on our products and a list of Kramer distributors, visit our Web site: www.kramerelectronics.com, where updates to this user manual may be found. We welcome your questions, comments and feedback.



Caution

Safety Warning:

Disconnect the unit from the power supply before opening/servicing.



Kramer Electronics, Ltd.

Web site: www.kramerelectronics.com

E-mail: info@kramerelectronics.com

P/N: 2900-000282 REV 2