

GE Infrastructure  
Sensing



**TransPort™ PT878GC**  
***Portable Gas Flowmeter***

**User's Manual**



GE Infrastructure  
Sensing

TransPort™ PT878GC  
*Panametrics Portable Gas Flowmeter*



User's Manual  
910-229B1  
December 2004

TransPort™ is a GE Panametrics product. GE Panametrics has joined other GE high-technology sensing businesses under a new name—GE Infrastructure Sensing.



---

## Warranty

Each instrument manufactured by GE Infrastructure Sensing, Inc. is warranted to be free from defects in material and workmanship. Liability under this warranty is limited to restoring the instrument to normal operation or replacing the instrument, at the sole discretion of GE Infrastructure Sensing, Inc. Fuses and batteries are specifically excluded from any liability. This warranty is effective from the date of delivery to the original purchaser. If GE Infrastructure Sensing, Inc. determines that the equipment was defective, the warranty period is:

- one year from delivery for electronic or mechanical failures
- one year from delivery for sensor shelf life

If GE Infrastructure Sensing, Inc. determines that the equipment was damaged by misuse, improper installation, the use of unauthorized replacement parts, or operating conditions outside the guidelines specified by GE Infrastructure Sensing, Inc. , the repairs are not covered under this warranty.

---

**The warranties set forth herein are exclusive and are in lieu of all other warranties whether statutory, express or implied (including warranties or merchantability and fitness for a particular purpose, and warranties arising from course of dealing or usage or trade).**

---

## Return Policy

If a GE Infrastructure Sensing, Inc. instrument malfunctions within the warranty period, the following procedure must be completed:

1. Notify GE Infrastructure Sensing, Inc., giving full details of the problem, and provide the model number and serial number of the instrument. If the nature of the problem indicates the need for factory service, GE Infrastructure Sensing, Inc. will issue a RETURN AUTHORIZATION NUMBER (RAN), and shipping instructions for the return of the instrument to a service center will be provided.
2. If GE Infrastructure Sensing, Inc. instructs you to send your instrument to a service center, it must be shipped prepaid to the authorized repair station indicated in the shipping instructions.
3. Upon receipt, GE Infrastructure Sensing, Inc. will evaluate the instrument to determine the cause of the malfunction.

Then, one of the following courses of action will then be taken:

- If the damage is covered under the terms of the warranty, the instrument will be repaired at no cost to the owner and returned.
- If GE Infrastructure Sensing, Inc. determines that the damage is not covered under the terms of the warranty, or if the warranty has expired, an estimate for the cost of the repairs at standard rates will be provided. Upon receipt of the owner's approval to proceed, the instrument will be repaired and returned.

## Table of Contents

### Chapter 1: Features and Capabilities

Overview .....	1-1
System Description .....	1-3
The Flowcell .....	1-3
Electronics Package .....	1-4
Theory of Operation.....	1-5

### Chapter 2: Initial Setup

Making Electrical Connections .....	2-2
Power Connections.....	2-2
Transducer Connections.....	2-3
Analog Input/Output Connections.....	2-3
The Infrared Wireless Interface .....	2-4
Charging and/or Replacing Batteries.....	2-5
Charging the Batteries .....	2-5
Replacing the Batteries.....	2-6
Powering On and Off.....	2-7
Using the Screen and Keypad .....	2-10
Screen.....	2-10
Keypad.....	2-12
Obtaining On-Line Help.....	2-14

### Chapter 3: Installing the Dampening Material, Transducers and Fixtures

Application Requirements .....	3-3
Preparing the Pipe .....	3-5
Performing a Pipe Survey.....	3-6
Obtaining the Transducer Spacing .....	3-8
Installing the V Series Clamping Fixture and Transducers 3-9	
Installing the Fixture.....	3-9
Installing the Transducers .....	3-11
Installing the PI Fixture and Transducers .....	3-13
Surveying the Pipe .....	3-13
Installing the First Bracket with a Chain .....	3-16
Installing the Second Bracket with a Chain .....	3-17
Installing the Transducers .....	3-18

## Table of Contents (cont.)

### Chapter 3: Installing the Dampening Material, Transducers and Fixtures (cont.)

Installing Dampening Material .....	3-20
Installing DMP-1 Dampening Material with CFG-V Series Fixtures .....	3-21
Installing DMP-1 Dampening Material with PI Fixture .....	3-24
Installing DMP-3 Compound with All Fixtures .....	3-26
Installing the PDJ Dampening Jacket .....	3-28

### Chapter 4: Programming Site Data

Entering the Program Menu .....	4-2
Entering Transducer Parameters .....	4-3
Entering Pipe Parameters .....	4-7
Entering Pipe Lining Parameters .....	4-11
Entering Fluid Types and Speeds .....	4-13
Entering the Signal Path Parameters .....	4-15
Path Parameters for Clamp-On Transducers .....	4-16
Entering the Standard Volume/ Mass Flow Parameters .....	4-17
Entering Inputs in the Standard Volume Option .....	4-19
Entering Mass Flow Parameters .....	4-22
Entering Skan/Measure Parameters .....	4-24
Entering Skan/Measure Integrate Parameters .....	4-28
Entering Skan/Measure Count Parameters .....	4-30
Entering Skan/Correlation Parameters .....	4-32
Entering Analog Inputs .....	4-34
Entering General-Purpose Analog Inputs .....	4-34
Entering Analog Inputs in Standard Volume or Mass Flow Option .....	4-37
Entering the Analog Output .....	4-39
Entering the Digital Output .....	4-42
Entering User Functions .....	4-46
Entering Correction Factors .....	4-50
Entering Reynolds Correction .....	4-50
Entering a Calibration Factor .....	4-53

## Table of Contents (cont.)

### Chapter 5: Creating and Managing Sites

The Site Manager .....	5-2
Creating a New Site .....	5-4
Opening an Existing Site .....	5-6
Saving a Site .....	5-7
Saving a Site with a Different Name .....	5-8
Refreshing a Site .....	5-9
Renaming a Site .....	5-9
Deleting a Site .....	5-10
Creating a Site Message .....	5-11
Printing a File .....	5-13
Transferring a Site File to a PC .....	5-13
Transferring a File as Text .....	5-14
Transferring a File from a PC to the PT878GC .....	5-15
Listing Files by Name .....	5-17
Listing Files in Chronological Order .....	5-17

### Chapter 6: Displaying and Configuring Data

The Format Option .....	6-2
The View Option .....	6-4
The Limits Option .....	6-5
The Measurement Option .....	6-7
Customizing the Display Screen .....	6-9
Specifying the Number of Displayed Parameters .....	6-10
Customizing Softkeys .....	6-11
Managing Files — The Drive Manager .....	6-14
Refreshing a File .....	6-16
Transferring a File to a PC .....	6-16
Transferring a File from a PC to the PT878GC .....	6-17
Deleting a File .....	6-19
Listing Files by Name .....	6-20
Listing Files in Chronological Order .....	6-20
Accessing Meter Data — The About Option .....	6-21

## Table of Contents (cont.)

### Chapter 7: Programming Meter Settings

Entering the Meter Menu .....	7-2
Selecting Measurement Units.....	7-3
The Battery Charger .....	7-5
Entering Date and Time .....	7-7
Changing Date and Time Appearance (Locale) .....	7-9
Adjusting the Contrast .....	7-12
Setting Backlight Timeout .....	7-14
Changing Communications Parameters.....	7-15
Resetting Forward and Reverse Totals .....	7-18
Setting Up User Tables .....	7-19
Taking a Bitmap Capture of a Current Screen.....	7-23



## Table of Contents (cont.)

### Chapter 8: Logging Data

Entering the Logging Menu .....	8-2
The Log Manager .....	8-3
The File Menu .....	8-4
Setting up a New Log .....	8-5
Copying (Cloning) a Selected Log .....	8-10
Renaming a Log .....	8-11
Deleting a Log .....	8-11
Deleting All Logs .....	8-12
Refreshing a Log .....	8-12
Printing a Log .....	8-13
Transferring a Log to a PC .....	8-13
The Log Menu .....	8-14
Stopping (Pausing) a Log .....	8-15
Restarting a Log .....	8-15
Ending a Log .....	8-15
Pausing All Logs .....	8-16
Restarting All Logs .....	8-16
Ending All Logs .....	8-16
View All Sites .....	8-16
The View Menu .....	8-17
Displaying Log Details .....	8-18
Displaying Log Data in Graphical Form .....	8-19
Displaying Log Data in Spreadsheet Form .....	8-22
The Sort Menu .....	8-23
Listing Logs by Name .....	8-23
Listing Logs in Chronological Order .....	8-23

## Table of Contents (cont.)

### Chapter 9: Servicing the PT878GC

Entering the Service Menu.....	9-2
Printing Reports.....	9-3
Setting up the Thickness Gauge.....	9-5
Measuring Pipe Wall Thickness .....	9-7
Entering the Material and Sound Speed .....	9-7
Measuring Thickness in Numeric Format .....	9-9
Displaying the Receive Signal in Graphical Format.....	9-10
Calibrating the Thickness Gauge Transducer .....	9-12
Calculating Velocity (Pipe Material Sound Speed) ..	9-14
Programming the Thickness Gauge .....	9-17
Displaying Diagnostic Parameters .....	9-20
Calibrating the Analog Output and Inputs .....	9-21
Calibrating the Analog Output .....	9-21
Calibrating Inputs .....	9-23
Setting up Signal Parameters.....	9-25
Setting up Signal Parameters .....	9-26
Setting up the Measurement Mode.....	9-28
Setting Up Pulse/Code Parameters.....	9-30
Setting Error Limits.....	9-32
The Test Option .....	9-35
Testing the Screen .....	9-36
Testing the Keys .....	9-37
Testing the Watchdog Timer Circuit .....	9-38
Setting Impulse Response .....	9-39
Taking Wave Samples for Diagnosis.....	9-40
Applying a Stored Signal for Diagnosis .....	9-40
Testing the Battery .....	9-41
Resetting to Factory Default Parameters.....	9-42
Updating PT878GC Software .....	9-43
Updating Software Via IrOBEX .....	9-44
Updating Software Via IrCOMM .....	9-46

## Table of Contents (cont.)

### Chapter 10: Diagnostics and Troubleshooting

Error Code Messages.....	10-2
Displaying Diagnostic Parameters.....	10-6
Flowcell Problems.....	10-9
Gas Problems.....	10-9
Pipe Problems.....	10-10
Transducer Problems.....	10-11

## Table of Contents (cont.)

### Chapter 11: Specifications

Operation and Performance .....	11-2
Fluid Types .....	11-2
Pipe Sizes .....	11-2
Pipe Wall Thickness .....	11-2
Pipe Materials .....	11-2
Clamp-On Flow Accuracy (Velocity) .....	11-2
Repeatability .....	11-2
Range (Bidirectional) .....	11-2
Rangeability (Overall) .....	11-2
Pressure Requirements, Air .....	11-3
Pressure Requirements, Other Gases .....	11-3
Measurement Parameters .....	11-3
Electronics .....	11-4
Flow Measurement .....	11-4
Enclosures .....	11-4
Dimensions .....	11-4
Display .....	11-4
Keypad .....	11-4
Internal Battery .....	11-4
Battery Charger Input .....	11-4
Memory .....	11-4
Operating Temperature .....	11-4
Storage Temperature .....	11-4
Standard Inputs/Outputs .....	11-5
Digital Interfaces .....	11-5
Site Parameter Programming .....	11-5
Data Logging .....	11-5
Display Functions .....	11-5
European Compliance .....	11-5
Clamp-On Ultrasonic Flow Transducers .....	11-6
Temperature Range(s) .....	11-6
Transducer Materials .....	11-6
Fixture Materials .....	11-6
Mountings .....	11-6
Mounting Couplant .....	11-6
Area Classifications .....	11-6
Transducer Cables .....	11-7

**Table of Contents (cont.)**

**Chapter 11: Specifications (cont.)**

Thickness Gauge Option .....	11-8
Transducer .....	11-8
Pipe Thickness Range .....	11-8
Pipe Materials.....	11-8
Accuracy .....	11-8
Thermal Exposure.....	11-8
Additional Options .....	11-8
PC Communication.....	11-8
RS232-to-Infrared.....	11-8
Printer .....	11-8

**Appendix A: Menu Maps**

**Appendix B: Establishing IR Communications with the PT878GC**

Windows 2000/XP.....	B-2
Windows NT4.0 .....	B-2
Windows Me/98SE/98/95.....	B-2

**Appendix C: Ultrasonic Thickness Gauge Theory of Operation**

Factors Affecting Performance and Accuracy .....	C-2
--	-----

**Appendix D: Material Safety Data Sheets for Couplants**

# Chapter 1

## Features and Capabilities

---

The TransPort® Model PT878GC is a transit-time clamp-on gas flowmeter which combines all the features of a full-size gas flowmeter with the advantages of a portable instrument.

This section describes the TransPort features and general system, and explains the theory of operation.

---

### Overview

The PT878GC is available in two models. While the PT878GC-01 covers pipe sizes from 3/4 in. to 12 in. (20 to 300 mm), the PT878GC-02 covers pipe sizes from 4 to 24 in. (100 to 300 mm). (To identify your PT878GC, refer to the label on the back of the electronics unit, shown in Figure 3-2 on page 3-3.) The flowmeter provides one linear 0/4-20 mA analog output of flow velocities or volumetric flow rate of clean, dry gases, measuring velocities from  $\pm 1$  to  $\pm 120$  ft/sec ( $\pm 0.3$  to  $\pm 40$  m/sec), along with one selectable frequency or pulsed totalizer output. Figure 1-1 illustrates the PT878GC in use on a typical pipe, along with the case for the PT878GC and accessories.

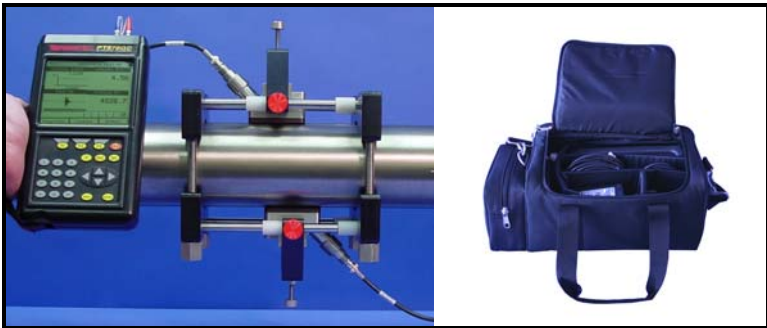

Figure 1-1: PT878GC in Use and in Case

## Overview (cont.)

The TransPort has the ability to store site data in files which can be accessed at a later time. Within the Main Menu, a set of forms (windows) asks you all the necessary setup information for a particular site. Once you answer the necessary questions, you simply save the information to a file.

The TransPort stores these files and other data in non-volatile memory, which retains the information even if power is turned off. The flowmeter itself runs on rechargeable or alkaline batteries for up to 8 hours.

This small, lightweight flowmeter displays measurements in both numeric and graphical form on a 240 x 200 pixel, EL-backlit LCD graphic screen. The TransPort also has the capability of logging over 100,000 flow data points internally.

Using an infrared communications port, the TransPort can transmit or print logged data, as well as site files, real time data and other stored data.

To assist you, the TransPort is fully equipped with context-sensitive on-line help which is accessible at any time by simply pressing the “?” (Help) key. Internal diagnostic and troubleshooting features help isolate and remedy common flowcell and transducer problems.

---

## System Description

The TransPort is only one part of the flowmeter system. The other part of the system is the flowcell, which consists of the pipe and the transducers.

### The Flowcell

The flowcell is that part of the system that uses ultrasonic pulses to interrogate the flow. It consists of the flowcell pipe and the transducers.

- A. FLOWCELL PIPE** - The flowcell can either be created in the existing piping (for example, by clamping non-wetted transducers onto the pipe), or inserted as a substitute pipe section (spoolpiece). The flowcell must provide mechanical support for the transducers and assure stable conditions for accurate flow measurement.
- B. TRANSDUCERS** - The transducers convert electrical energy into ultrasonic pulses when in a transmit cycle, and convert the ultrasonic pulses back to electrical energy when in a receive cycle. In other words, they act like loudspeakers when transmitting the signal and microphones when receiving it. In the TransPort system, each transducer acts as both a receiver and transmitter, since a series of ultrasonic pulses are alternately sent upstream and then downstream through the flowcell.



## Electronics Package

The TransPort consists of circuits that generate, receive, and measure the travel time of the ultrasonic pulses. It also contains a microcomputer that controls operation and calculates flow measurement parameters. Specific circuits function as follows:

- A. TRANSMIT SIGNAL GENERATOR** - The transmit signal generator, under control of the microcomputer and timing circuit, synthesizes the signal that drives the transmitter.
- B. TRANSMITTER** - The transmitter amplifies the signals from the transmit signal generator to a signal that drives the transmit transducer.
- C. RECEIVER** - The receiver amplifies the received signals to a level suitable for the data acquisition circuitry.
- D. DATA ACQUISITION** - The data acquisition circuitry digitizes the received signal and stores it in a buffer for processing by the microcomputer.
- E. TIMING CIRCUIT** - The timing circuit generates the transmitter frequency, receive window, controls the data acquisition circuit and the direction of the transmission.
- F. MICROCOMPUTER** - The microcomputer controls the TransPort flowmeter's operation and calculates flow measurements derived from the transmitted and digitized received signals. Also, the microcomputer continually checks for faults and allows the use of built-in diagnostics for troubleshooting.
- G. INPUT/OUTPUT** - The input/output circuitry allows the flowmeter to indicate the measured flow with the 0/4 to 20-mA current loop, and to output to a printer or other remote device.

---

## Theory of Operation

The TransPort is a transit-time ultrasonic flowmeter. When ultrasonic pulses are transmitted through a moving liquid or gas, the pulses that travel in the same direction as the fluid flow (downstream) travel slightly faster than the pulses that travel against the flow (upstream). The TransPort uses various digital signal processing techniques, including cross-correlation, to determine transit times and then uses the difference in transit times to calculate flow velocity.

During operation, two transducers serve as both ultrasonic signal generators and receivers. When mounted on a pipe, they are in acoustic communication with each other, so that each transducer can receive ultrasonic signals transmitted by the other transducer. Each transducer thus functions as a transmitter generating a certain number of acoustic pulses, and as a receiver for an identical number of pulses.

The flowmeter measures the time interval between transmission and reception of the ultrasonic signals in both directions. When the gas in the pipe is not flowing, the transit-time downstream equals the transit-time upstream. When the gas is flowing, the transit-time downstream is less than the transit-time upstream. The difference between the downstream and upstream transit-times is proportional to the velocity of the flowing gas, and its sign indicates the direction of flow.

# Chapter 2

## Initial Setup

---

Before making measurements, you must prepare the TransPort for operation. This includes the following procedures:

- Making Electrical Connections
- Charging and/or Replacing Batteries
- Powering On and Off
- Using the Screen and Keypad
- Obtaining On-Line Help

Figure 2-1 below shows the PT878GC in its specially designed case.



Figure 2-1: The PT878GC and Accessories

## Making Electrical Connections

Before making measurements with the TransPort, you must make all the necessary connections to the unit. This section describes how to connect the following:

- Power
- Transducer
- Analog Input/Output
- Infrared Interface

Make all connections to the top of the TransPort unit as shown in Figure 2-2 below. Please note that you only need to make the proper transducer connections. The other connections are required for particular functions, but are not necessary for basic operation.

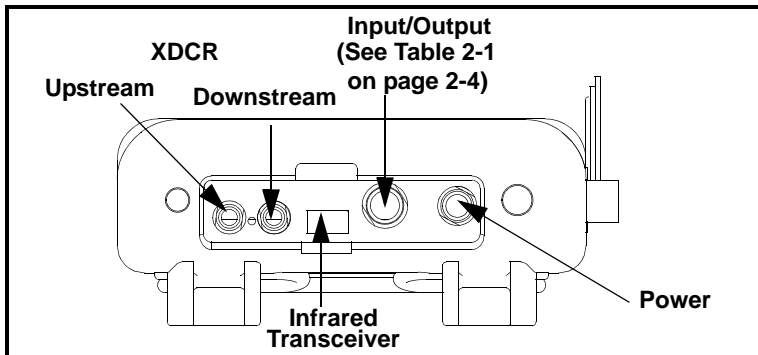

Figure 2-2: Connection Locations

### Power Connections

The PT878GC is powered by either a 100-120/200-260 VAC wall mount plug-in module, or by 5 internal C<sub>s</sub>-size NiCad high-energy rechargeable batteries or by a pack of 3.0 Ahr NiMH batteries. (An optional power supplement, part #703-1283, uses 6 AA alkaline batteries.) When you receive the PT878GC, the batteries are not charged; therefore, to make remote measurements using the batteries, follow the instructions on page 2-5 to charge the batteries. In either case, you must connect the power cord to the appropriate terminal as shown in Figure 2-2 above.

---

**!WARNING!**

To ensure the safe operation of the TransPort, you must install and operate it as described in this manual. In addition, be sure to follow all applicable safety codes and regulations for installing electrical equipment in your area.

---

## Transducer Connections

The transducer cables connect to the TransPort with LEMO<sup>®</sup> coaxial type connectors. Each color-coded cable has a collar labeled UPSTREAM or DOWNSTREAM. Make transducer cable connections to the top of the flowmeter as shown in Figure 2-2 on the previous page. Transducer installation is discussed separately in Chapter 3.

## Analog Input/Output Connections

The TransPort provides one 0/4-20 mA current output and two 4 to 20-mA analog inputs with switchable 16-V supply for loop- powered temperature transmitters. Connect the inputs/ outputs using a LEMO<sup>®</sup> multi-pin connector as shown in Figure 2-2 on the previous page. The pin numbers for the connector and the color code for the standard input/output cable are shown in Table 2-1 on the next page.

## Analog Input/Output Connections (cont.)

**Table 2-3: Cable Assembly for Analog Inputs/Outputs**

Pin Number	Wire Color	Description
1	Black	Analog Out 1
2	Red	16 V (switched)
3	White	Supply Temperature
4	Yellow	Return Temperature
5	Green	Analog Ground
6	Orange	Digital Output
7	Blue	Digital Ground
8	Violet	Receive Monitor

### The Infrared Wireless Interface

The PT878GC comes equipped with an internal infrared transceiver (see Figure 2-2 on page 2-2) that enables communication between the meter and other IR devices, particularly the IR ports or dongles (IR to RS232 adapters) of Windows<sup>®</sup>-based PCs. Users can send and receive site and log data. The PT878GC was designed for use with products that comply to the IrDA protocol. For more information on establishing IR communications between the PT878GC and your PC, refer to Appendix B.

## Charging and/or Replacing Batteries

The PT878GC comes with self-contained, built-in rechargeable batteries to support portable operation. For optimum performance, these batteries require a minimum of maintenance.









### Charging the Batteries

When you receive the PT878GC, you will need to initially charge the batteries. The batteries must be charged up to 8 hours to receive the maximum charge. When fully charged, the batteries provide 8 hours of continuous operation. An internal battery gauge indicates the remaining power in the batteries.

To charge the batteries, simply plug the AC power module cord into the power jack (shown in Figure 2-2 on page 2-2) and be sure the battery pack is installed. When the PT878GC is plugged into line voltage, the internal battery charger automatically charges the batteries, whether the PT878GC is on or off. If the PT878GC is on, the Battery icon in the upper right corner of the screen indicates battery status (as shown in Table 2-2 below).

**IMPORTANT:** *For CE compliance, the PT878GC is classified as a battery-powered device, not to be used with the AC adaptor.*

**Table 2-4: Battery Status Icons**

Icon	Battery Status
	Full battery
	Partially full battery
	Empty battery
	Fully charged battery, connected to AC power
	Charging battery
	Discharging battery
	Failure/missing battery
	Notification to check battery form (see page 7-5)

## Replacing the Batteries

---

### Caution!

Replace batteries only with the specified rechargeable batteries. The battery charges when the unit is off. Do not attempt to recharge non-rechargeable batteries.

---

If you need to replace the rechargeable batteries, use 5 C<sub>S</sub>-size NiCad high energy rechargeable batteries (GE Infrastructure Sensing Part Number 200-058) or 3.0 Ahr NiMH batteries (part number 200-081). To replace the batteries, remove the rubber boot, open the panel located on the back of the PT878GC unit, disconnect the batteries, and replace with new ones (see Figure 2-3 below).

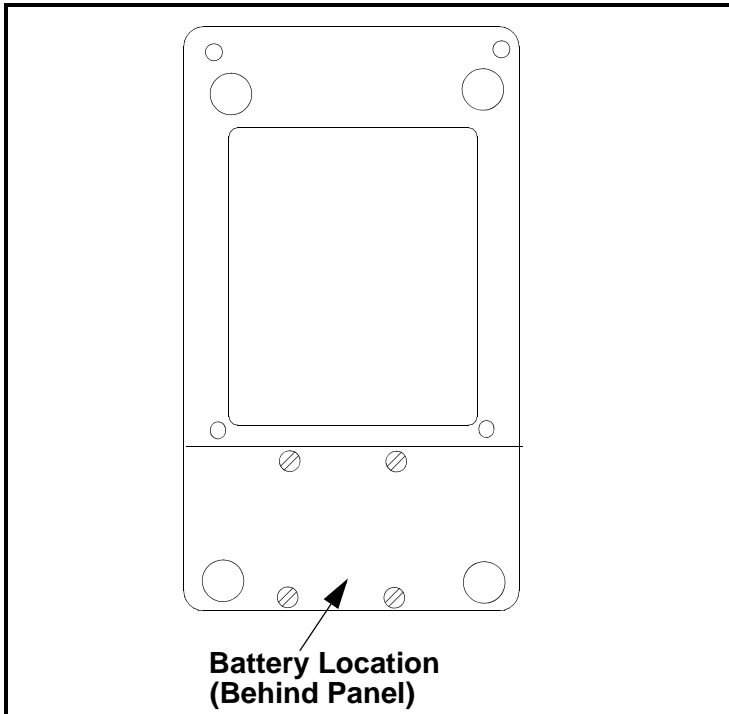

Figure 2-5: Rear View of PT878GC

To further extend the battery power on the PT878GC, the GE Infrastructure Sensing Part #705-1283 power pack option uses 6 AA alkaline batteries.



---

## Powering On and Off

To operate the PT878GC, the power cord must be plugged into line voltage or the battery must be charged as described previously.

**IMPORTANT:** *For CE compliance, the PT878GC is classified as a battery-powered device, and cannot be used with the AC adaptor.*

To turn the meter on, press the red button in the upper-right-hand corner of the keypad. Immediately upon power up the PT878GC emits a short beep and displays a “PCI Loader” message. It then validates the instrument programming, and then displays the GE Infrastructure Sensing logo and the software version and emits a long beep. If the meter fails any of these tests, contact GE Infrastructure Sensing.

---

### Caution!

If the meter fails the backup battery test, you must send the unit back to the factory for a battery replacement. Make sure you keep the NiCad batteries charged until you are ready to ship the unit back to the factory. Before shipping, print out all the log and site data, or transfer it to your PC, as this data will be lost during the service procedure.

---

## Powering On and Off (cont.)

After the meter conducts all the self checks, the screen then appears similar to the one shown in Figure 2-4 below.

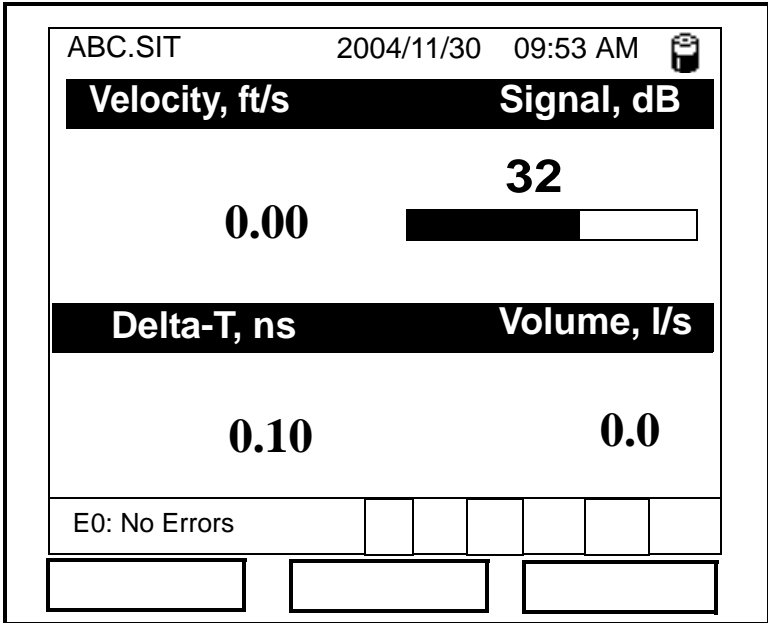

Figure 2-6: Screen After Powering On

---

## Powering On and Off (cont.)

To turn the PT878GC off, press the red key for 3 seconds. The screen now appears similar to Figure 2-5 below.

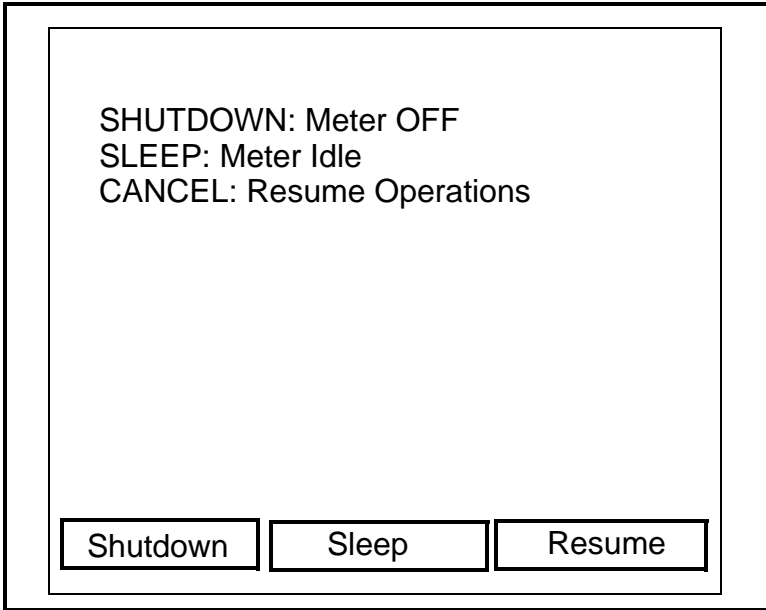

Figure 2-7: The Shutdown Menu

Three options are available:

- Press [F1] to shut down the PT878GC, turning it completely off.
- Press [F2] to send the PT878GC into sleep mode. In this mode, some of the power supplies shut down, but the PT878GC remains in a standby mode. Users can resume taking measurements immediately by pressing the power button.
- Press [F3] to cancel the command and return the PT878GC to normal operation.

If the PT878GC locks up, you can reset it by holding the power key (the red key in the upper right corner) for 15 seconds.

## Using the Screen and Keypad

The essential features for operating the TransPort are the screen and keypad. Although these features are common on portable instruments, the PT878GC design offers unique features to simplify and speed operation.

### Screen

The primary function of the screen is to display information in order for you to accurately and easily take measurements. The TransPort screen consists of seven parts (see Figure 2-6 below).

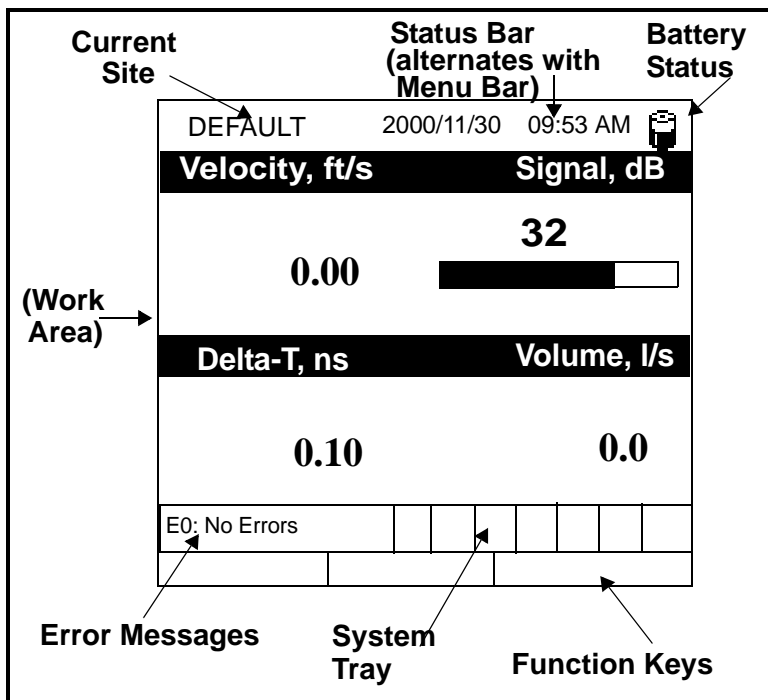

Figure 2-8: The PT878GC Screen in Operate Mode







The top line of the screen is the **status bar**, which normally displays the time, date and current site. However, when you press [MENU] (the menu key), the **Menu Bar** replaces the status bar.

## Screen (cont).

The middle of the screen is the **work area**, which displays the measured parameters, numeric measurements, and both bar and line graphs. (When you enter a selection on the Main Menu discussed in Chapter 4, *Programming Site Data*, this area displays menu prompts.) A line at the bottom of the area also displays error code messages, which are described in more detail in Chapter 10, *Diagnostics and Troubleshooting*.

The system tray, shown in Figure 2-6 on page 2-10, displays icons that indicate meter operations not otherwise shown. Table 2-3 below lists the icons and their meanings.

**Table 2-9: Icons in the System Tray**

Icon	Function	Meaning
	IR Transfer	IR data transfer in progress.
	Alert	Indicates the meter encountered an error in operation.
	Log Running	Indicates a log is running (marks).
	Log Pending	Indicates a log is pending (no marks).
	Stopwatch	Calibration Gate Operation: Watch is stopped when the gate is closed, or runs when it is open. (See page 3-46.)
 	Snapshot (To file) (To Printer)	Indicates that the Snapshot function has been activated, so users can take screen captures (see page 6-23).

The bottom of the screen displays the three feature key options: F1, F2 and F3. The feature keys have different functions, depending on the task you are performing.

## Keypad

The PT878GC keypad has 25 keys. The functions for each key are as follows (see Figure 2-7 on the next page):

- 3 function keys ([F1], [F2], [F3]) — enable you to select the special functions which appear at the bottom of the screen.
- 12 numeric keys (including - and .) — enable you to enter numeric data.
- 4 arrow keys ([◀], [▶], [▲], [▼]) — enable you to move through the menu options.
- [?] — Help key enables you to access on-line help.
- [MENU] — Menu key enables you to access the Menu Bar.
- [ENTER] — enables you to enter a particular menu, and enters selected values into the TransPort memory.
- [SEL] — enables you to move between data measurements on the screen.
- [ESC] — enables you to exit menus or menu options at any time; cancels numeric entry.
- Red key [Ⓚ] turns the power on or off, and toggles the backlight on or off.

## Keypad (cont.)

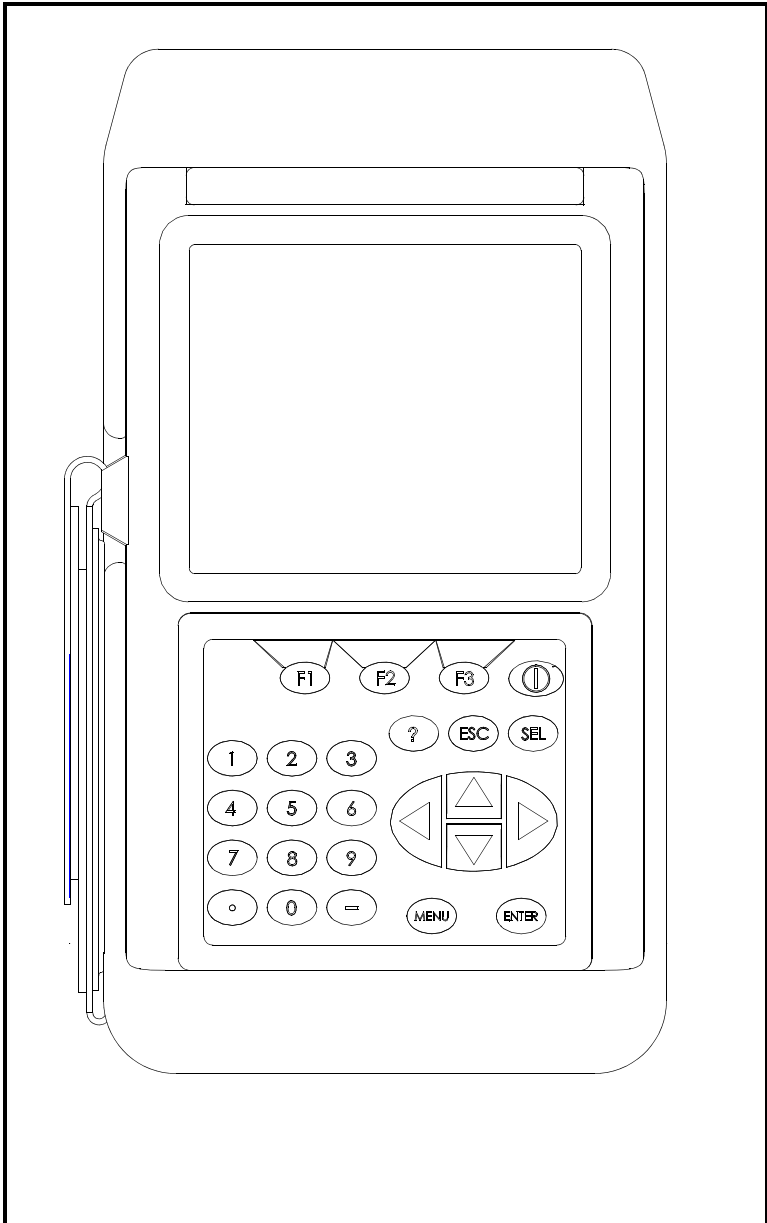
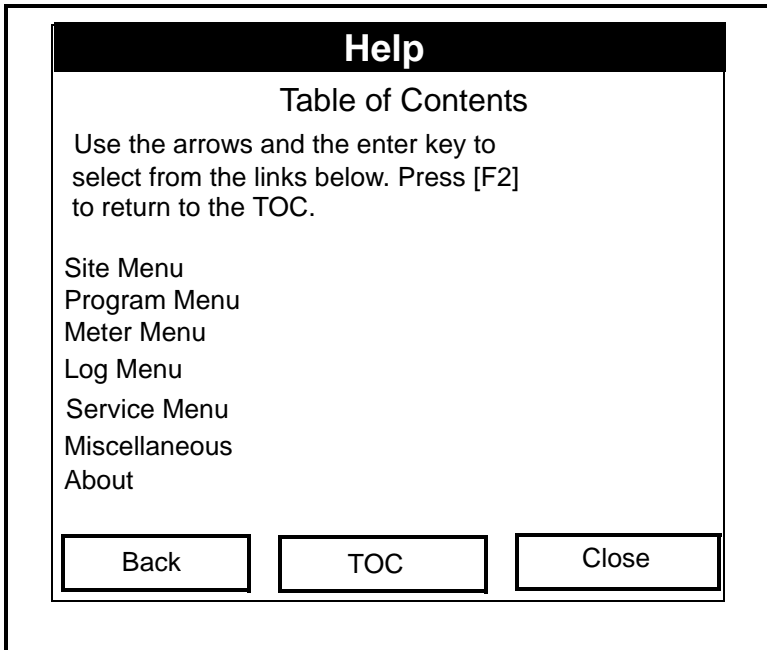

Figure 2-10: The TransPort PT878GC Keypad

---

## Obtaining On-Line Help

The TransPort offers on-line help screens that describe various features. You can access on-line help at any time by pressing the [?] key. The screen appears similar to Figure 2-8 below.



**Figure 2-11: The Main Help Menu**

Use the three function keys and the [▲] and [▼] arrow keys to navigate to the desired menu, and press [ENTER]. Repeat this procedure to access the desired topic within the menu. When you have finished using the Help menu:

- Press [F1], Back, to move back one level.
- Press [F2], TOC, to return to the Table of Contents.
- Press [F3], Close, to return to the previous screen.



## Chapter 3

# Installing the Dampening Material, Transducers and Fixtures

---

Since the PT878GC is specifically designed for gas measurement with clamp-on transducers, it requires the use of specially designed fixtures and dampening material to maintain the highest possible measurement accuracy. GE Infrastructure Sensing supplies the CFG series of fixtures:

- The V1 clamping fixture for pipes with diameters between 0.75 and 1.25 in. (20 to 30 mm).
- The V4 clamping fixture for pipes with diameters between 1.25 and 4 in. (30 to 100 mm).
- The V8 clamping fixture for pipes from 4 to 8 in. (100 to 200 mm).
- The V12 clamping fixture for pipes from 8 to 12 in. (200 to 300 mm).
- The PI clamping fixture for pipes from 12 to 24 in. (300 to 600 mm).

Figure 3-1 on the next page illustrates the V series and PI fixture assemblies. Complete the steps in the following sections to position and install the transducers, fixtures and dampening material.

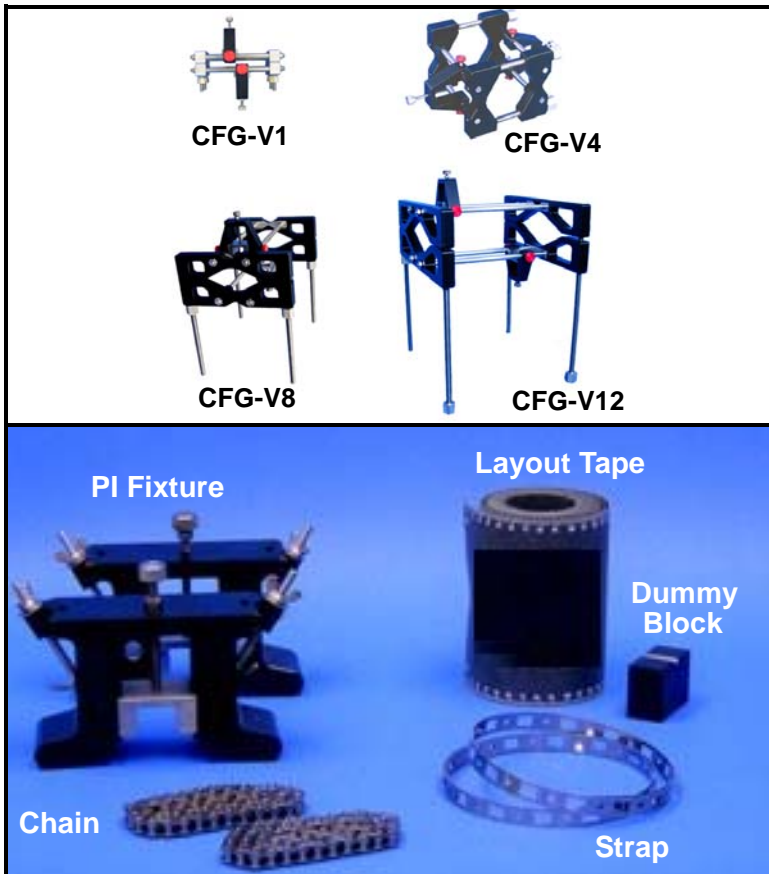

**Figure 3-1: The V Series and PI Fixtures**

Choosing the transducer installation locations on the pipe is an important aspect of proper flow measurement. Specifications assume a fully developed flow profile typically requiring 20 diameters upstream and 10 diameters downstream of straight pipe run. In addition, pipes 2 in. and under require an installation location with a minimum of 10 ft (3 m) of continuous straight pipe without flanges, welds or coupling joints.

## Application Requirements

Before you begin to use the PT878GC, you should ensure that your meter can handle the frequencies required for your particular application. To check the capabilities of your particular PT878GC, refer to the back label of the PT878GC, shown in Figure 3-2 below. The gray label below “Communication” lists the meter type and transducer frequency the PT878GC can support.





TRANSDUCER	COMMUNICATION	INPUT/OUTPUT	POWER
UP-STREAM DOWN-STREAM 	 INFRARED COMMUNICATIONS PORT <div style="border: 1px solid gray; padding: 5px; text-align: center;"> <b>PT878GC-02</b>              200KHz TO 500KHz           </div>	 1. 4-20mA ANALOG OUTPUT 2. +18V (switched) 3. ANALOG INPUT A 4. ANALOG INPUT B 5. ARTN 6. DIGITAL OUTPUT 7. DRTN 8. RECEIVE MONITOR	 1. +12VDC 2. RTN 3. N.C. 4. N.C.
<b>POWER KEY</b> HOLD FOR 1 SECOND TO TOGGLE BACK LIGHT ON/OFF. HOLD FOR 3 SECONDS TO SHUTDOWN METER. HOLD FOR 15 SECONDS TO RESET METER.	<b>SEL SELECT KEY</b> <b>MAIN SCREEN</b> - PRESS TO MOVE CURSOR TO FIRST DATA VIEW. PRESS AGAIN TO MOVE TO NEXT. <b>UNIT TYPE SELECTOR</b> - PRESS AFTER DATA SOURCE HAS BEEN CHOSEN TO MOVE TO UNIT TYPE SELECTIONS.	<b>7 HELP KEY</b> <b>CONTEXT SENSITIVE HELP</b> - PRESS ON ANY FORM TO BRING UP RELATED HELP HELP IS HYPERLINKED FOR EASY NAVIGATION OF TOPICS.	
<b>MENU KEY</b> PRESS TO OPEN MENU BAR ON MAIN SCREEN AND FORMS. PRESS AGAIN TO CLOSE MENU. (NOTE: NOT ALL FORMS CONTAIN MENUS)	<b>7 HELP KEY</b> <b>CONTEXT SENSITIVE HELP</b> - PRESS ON ANY FORM TO BRING UP RELATED HELP HELP IS HYPERLINKED FOR EASY NAVIGATION OF TOPICS.	<b>F1 FUNCTION KEYS</b> <b>F2</b> - CUSTOMIZED ON THE MAIN SCREEN TO HOLD QUICK LINK MENU ITEMS. SEE MANUAL FOR DETAILED INSTRUCTIONS. <b>F3</b> - SPECIALIZED FORM NAVIGATION SPECIFIC TO CURRENT FORM. FUNCTION CAN BE SEEN DIRECTLY ABOVE THE FUNCTION KEYS.	
<b>ENTER KEY</b> <b>CONTROLS</b> - PRESS ONCE TO ACTIVATE CONTROL. PRESS AGAIN TO ACCEPT CHANGES. <b>MENUS</b> - PRESS TO OPEN SELECTED FORM. <b>DATA VIEWS</b> - PRESS TO OPEN DATA VIEW MENUS.			
<b>ESC ESCAPE KEY</b> PRESS ANYWHERE TO CANCEL THE CURRENT OPERATION. IF NO CONTROL IS CURRENTLY BEING EDITED, THE FORM WILL CLOSE.			
 <b>GE Panametrics</b>			
		GE PANAMETRICS 221 CRESCENT STREET WALTHAM, MA 02453	GE PANAMETRICS SHANNON AIRPORT SHANNON, IRELAND
<b>WARNING</b> USE ONLY RECHARGEABLE NIMH BATTERIES PART NO. 200-081 OR 6 AA ALKALINE BATTERIES WITH 703-1283. DISCONNECT POWER AND BATTERIES BEFORE OPENING. CHARGE ONLY WITH SPECIFIED CHARGERS, TO AVOID POTENTIAL INJURY, DO NOT OPEN BATTERY, DISPOSE OF IN FIRE OR SHORT CIRCUIT.			

Figure 3-2: PT878GC Back Label

In addition to checking the available frequencies, you should determine that your application meets the minimum gas pressure and maximum flow velocity range requirements for optimal measurements, given the pipe size and pipe thickness. Table 3-1 on page 3-4 lists the minimum pipe sizes, schedules, and pressures for use with the PT878GC.

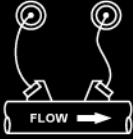
Table 3-1: PT878GC Installation Requirements

	Pipe Size in. (mm)	Transducer (Normal Temp.)	Installation Requirements for Minimum Required Pressure with Resultant Maximum Flow								
			Number of Traverses	Pipe Wall Thickness in. (mm)	Pressure psig (bar)			Maximum Flow Velocity ft/s (m/s)			
					Air	NG	Steam	Air	NG	Steam	
PT878GC-02	PT878GC-01	3/4 (20)	1.0 MHz	5	≤0.07 (1.8)	60 (5.1)	N/A	N/A	90 (27.4)	N/A	N/A
		1 (25)	1.0 MHz	3	≤0.14 (3.6)	60 (5.1)	N/A	N/A	90 (27.4)	N/A	N/A
		1.5 (40)	1.0 MHz	3	≤0.15 (3.8)	60 (5.1)	N/A	N/A	90 (27.4)	N/A	N/A
		2 (50)	1.0 MHz	3	≤0.16 (4.1)	60 (5.1)	200 (14.8)	N/A	90 (27.4)	110 (33.5)	N/A
		3 (75)	0.5 MHz	1	≤0.22 (5.6)	60 (5.1)	200 (14.8)	N/A	120 (36.6)	120 (36.6)	N/A
		4 (100)	0.5 MHz	1	≤0.24 (6.1)	60 (5.1)	150 (11.4)	110 (8.6)	120 (36.6)	120 (36.6)	120 (36.6)
				1	≤0.34 (8.6)	180 (13.4)	400 (28.6)	200 (14.8)			
				3	≤0.68 (17.3)	300 (21.7)	800 (56.2)	N/A	72 (21.9)	72 (21.9)	N/A
		6 (150)	0.5 MHz	1	≤0.28 (7.2)	60 (5.1)	150 (11.4)	110 (8.6)	90 (27.4)	120 (36.6)	120 (36.6)
				1	≤0.44 (11.2)	180 (13.4)	400 (28.6)	200 (14.8)			
				3	≤0.87 (22.1)	300 (21.7)	800 (56.2)	N/A	55 (16.8)	72 (21.9)	N/A
		8 (200)	0.5 MHz	1	≤0.33 (8.4)	60 (5.1)	175 (13.1)	120 (9.3)	80 (24.4)	100 (30.5)	100 (30.5)
	1			≤0.5 (12.7)	180 (13.4)	400 (28.6)	200 (14.8)				
	1		0.2 MHz	1	≤0.88 (22.4)	300 (21.7)	800 (56.2)	N/A	80 (24.4)	100 (30.5)	N/A
	10 (250)	0.5 MHz	1	≤0.37 (9.4)	60 (5.1)	200 (14.8)	130 (10.0)	70 (21.3)	85 (25.9)	85 (25.9)	
			1	≤0.5 (12.7)	180 (13.4)	500 (35.5)	200 (14.8)				
		1	0.2 MHz	1	≤1.0 (25.4)	300 (21.7)	800 (56.2)	N/A	70 (21.3)	85 (25.9)	N/A
	12 (300)	0.5 MHz	1	≤0.38 (9.7)	60 (5.1)	250 (18.3)	140 (10.7)	55 (16.8)	70 (21.3)	70 (21.3)	
			1	≤0.5 (12.7)	180 (13.4)	500 (35.5)	200 (14.8)				
		1	0.2 MHz	1	≤1.0 (25.4)	300 (21.7)	800 (56.2)	N/A		N/A	
	14 (350)	0.2 MHz	1	≤0.38 (9.7)	90 (7.2)	300 (21.7)	N/A	50 (15.2)	60 (18.3)	N/A	
			1	≤0.5 (12.7)	270 (19.6)	800 (56.2)	N/A				
	16 (400)	0.2 MHz	1	≤0.38 (9.7)	90 (7.2)	300 (21.7)	N/A	40 (12.2)	54 (16.5)	N/A	
			1	≤0.5 (12.7)	270 (19.6)	800 (56.2)	N/A				
18 (450)	0.2 MHz	1	≤0.38 (9.7)	90 (7.2)	300 (21.7)	N/A	35 (10.7)	50 (15.2)	N/A		
		1	≤0.5 (12.7)	270 (19.6)	800 (56.2)	N/A					
20 (500)	0.2 MHz	1	≤0.38 (9.7)	90 (7.2)	300 (21.7)	N/A	35 (10.7)	43 (13.1)	N/A		
		1	≤0.5 (12.7)	270 (19.6)	800 (56.2)	N/A					
24 (600)	0.2 MHz	1	≤0.38 (9.7)	90 (7.2)	300 (21.7)	N/A	30 (9.1)	36 (11.0)	N/A		
		1	≤0.5 (12.7)	270 (19.6)	800 (56.2)	N/A					

## Preparing the Pipe

1. Locate a transducer measurement point with 20 diameters of upstream straight run pipe and 10 diameters of downstream straight run pipe. In addition, the point should be be at least 10 diameters from any butt welds or flanges. Keep appropriate clearance on either side of the pipe for easy transducer installation:

- 150 mm (6 in.) if you are not using a junction box, or
- 225 mm (9 in.) if you are using a junction box.

In general, transducers are installed 180° apart on opposite sides of the pipe and in a horizontal plane (at 3 and 9 o'clock). Figure 3-3 below illustrates the desired acoustic signal projection path for general installation; however, additional pipe surveys may provide data that can lead to modifications for optimal installation.

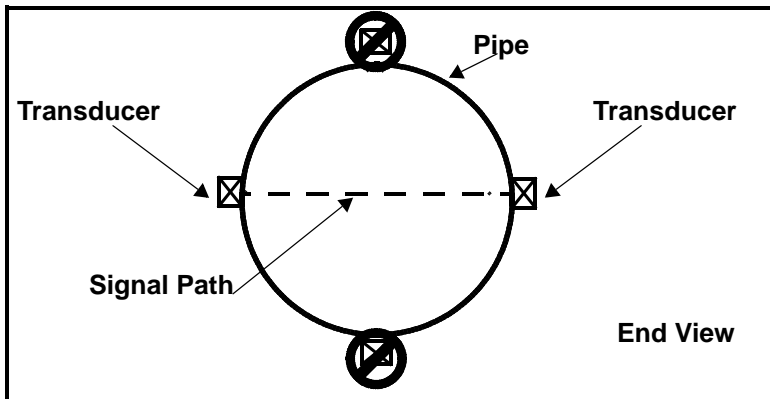
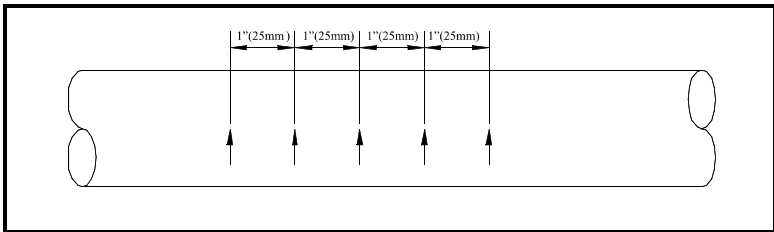

Figure 3-3: Desired Projection of Acoustical Signal Path

## Performing a Pipe Survey

Finding a location where the pipe is concentric is important for optimum accuracy and performance. If possible, perform a pipe survey with an ultrasonic thickness gauge to find the best location.

2. Clear rust or loose paint and measure the wall thickness at five points along the pipe axis at 25 mm (1-in.) intervals using an ultrasonic thickness gauge, as shown in Figure 3-4 below. Check each point three times and record the mean values. If the maximum variation between the five points exceeds 0.25 mm (0.010 in.), find another location.



**Figure 3-4: Measuring Thickness Along the Pipe Axis**

3. Measure the outside diameter (OD) of the pipe using a tape measure or the supplied layout tape. Using the entire layout tape, mark two circumferential lines along the edges of the wrap, as shown in Figure 3-5 below.



**Figure 3-5: Measuring and Marking Circumference Lines**

## Performing a Pipe Survey (cont.)

- Now measure the OD and the wall thickness at eight points along the pipe circumference at  $45^\circ$  intervals (shown in Figure 3-6 below), three times per point, and record the mean values.

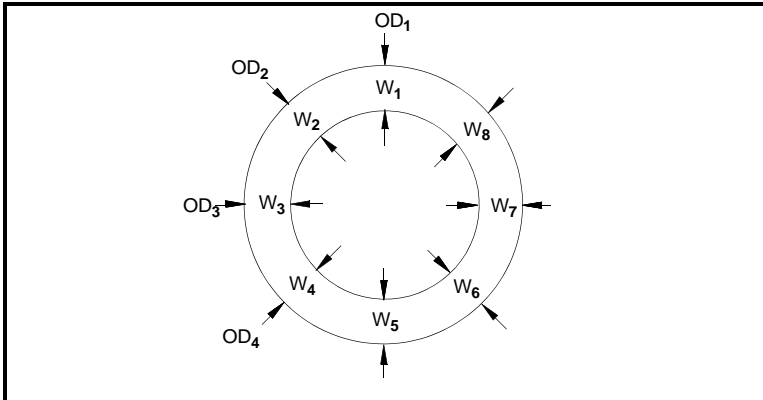

**Figure 3-6: Measuring the OD and Pipe Wall Thickness**

- Prepare the pipe for the dampening material by removing any rust or loose paint and sanding down any rough spots in an area 12 in. long around the circumference of the pipe. Take care to preserve the original pipe curvature.
- At the approximate location of each transducer, prepare an area 100 mm (4 in.) long by 50 mm (2 in.) wide for CRV type transducers and 100 mm wide for CRW type transducers. Remove any paint or rust, and polish the cleared area, taking care to preserve the original curvature of the pipe.

## Obtaining the Transducer Spacing

1. Using the measured OD and the pipe wall thickness, program the PT878GC (discussed in Chapter 4, *Programming Site Data*) to determine the required transducer spacing.
2. To determine the PT878GC correction factor, calculate the mean inside pipe diameter (ID) and the pipe ID at the transducer locations. Then divide the square of the mean ID by the square of the ID at the transducer location, as shown in the equations below, where  $OD_X$  is the outside diameter at a given point, and  $W_X$  is the wall thickness at a given point (as shown in Figure 3-6 on the previous page).

$$\text{mean ID} = ((OD_1 - (W_1 + W_5)) + (OD_2 - (W_2 + W_6)) + (OD_3 - (W_3 + W_7)) + (OD_4 - (W_4 + W_8))) / 4$$

$$K_{\text{for non-concentric pipe}} = \frac{(\text{Mean ID})^2}{(\text{ID at transducer location})^2}$$

3. Program the value into the PT878GC.

**Note:** See Chapter 4, *Programming Site Data*, pages 4-3 to 4-16, for more details on programming.

Based on the pipe OD, proceed to the appropriate section:

- If the pipe is  $\leq 12''$  (300 mm), see the section *Installing the V Series Clamping Fixture and Transducers* on the next page.
- If the pipe is  $> 12''$  (300 mm), go to *Installing the PI Fixture and Transducers* on page 3-12.



---

## Installing the V Series Clamping Fixture and Transducers

**Note:** *A complete installation involves the clamping fixture, transducers and dampening material. If you are using dampening material, refer to Installing Dampening Material on page 3-21.*

To install the V Series clamping fixture and transducers, complete the following steps:

### Installing the Fixture

1. Position the half of the clamping fixture with the threaded rods around the pipe, as shown in Figure 3-7 below. Orient the fixture in the 3 o'clock position on a horizontal pipe.
2. Position the mating half of the fixture over the threaded rods in the 9 o'clock position. Figure 3-7 below shows the two mounted halves.

**Note:** *If you are using a V4 fixture with a 1.5 to 2-in. pipe, GE Infrastructure Sensing suggests removing the nut and the mounting bracket, rotating it 180° and replacing the bracket and nut for a more secure fit.*

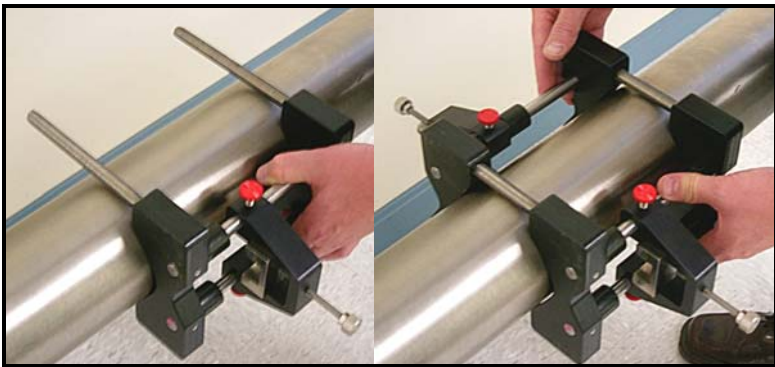

**Figure 3-7: Mounting the Two Halves of the Fixture**

## Installing the Fixture (cont.)

The two fixture halves have measuring scales; ensure that the scales are on the same side of the fixture, so that both zeros start at the same origin, as shown in Figure 3-8 below.

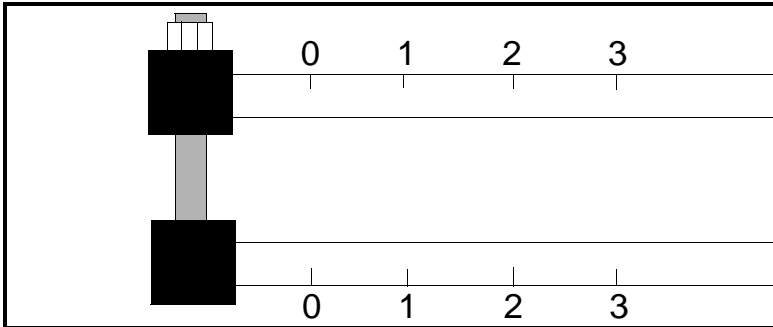

Figure 3-8: Fixture with Scale Origins Properly Aligned

3. Install the four nuts onto the threaded rods with the convex side of the nut facing the fixture. Hand tighten the nuts on each V block evenly, as shown in Figure 3-9 below. Do not use a cross tightening pattern on the four installation nuts.

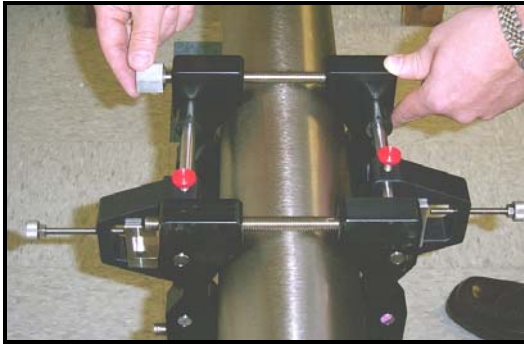
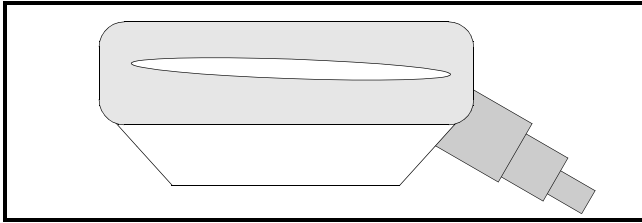

Figure 3-9: Installing Nuts onto the Fixture

## Installing the Transducers

1. Apply a bead of couplant 6 mm (0.25 in.) wide along the entire length of each transducer face, as shown in Figure 3-10 below.



**Figure 3-10: Couplant on Transducer Face**

**Note:** *Do not slide the transducer with couplant along the surface of the pipe when mounting the transducer.*

2. Set the first mounting block (either left edge or right edge) at a convenient number on the scale, such as 1 in. or 1 cm. Install the first transducer with the BNC connector pointing away from the center of the V block fixture. Tighten the transducer mounting thumbscrew onto the slider, which in turn applies pressure to the transducer. Use a handtight grip to set the transducer in contact with the pipe, as shown in Figure 3-11 below. Use a wrench to tighten the backing nut to prevent loosening due to vibration and thermal expansion.

**IMPORTANT:** *Do not use a wrench or pliers on the thumbscrew.*



**Figure 3-11: Installing the First Transducer**

## Installing the Transducers (cont.)

3. Slide the second mounting block to the calculated spacing *plus* the initial scale number selected for the first mounting block. For example:
  - a. Initial convenient number for the first mounting block = 1 cm or 1 in.
  - b. Spacing as calculated by the PT878GC = 0.5 in. or 12.5 mm
  - c. Second mounting block final location = 1 + 0.5 in. = 1.5 in.  
or 1 cm + 1.25 cm = 2.25 cm

The overall spacing between yokes should be left edge to left edge, or right edge to right edge. Figure 3-12 below shows typical positioning.

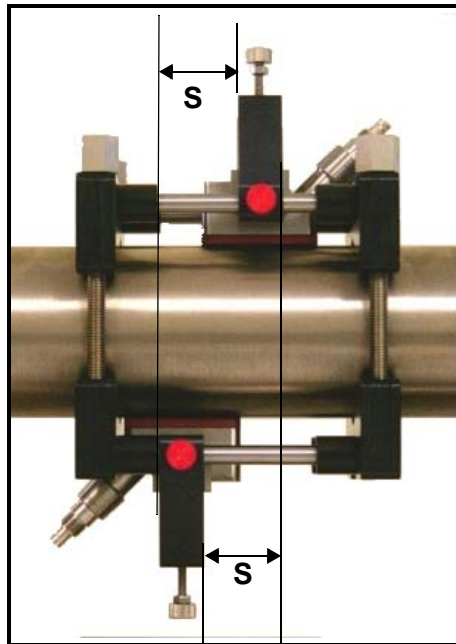

Figure 3-12: Top View of V4 Fixture with Both Transducers

4. In a similar manner, install the second transducer as shown in Figure 3-12 above.

## Installing the PI Fixture and Transducers

The PI clamping fixture holds transducers on pipes from 8 to 24 in. in diameter. It comes with either a chain or strap, depending on the selection made with the initial order from GE Infrastructure Sensing. To install the fixture and transducers, complete the following steps:

### Surveying the Pipe

1. Measure the pipe circumference to an accuracy of  $\pm 2$  mm ( $\pm 1/16$  in.)

**IMPORTANT:** *Do not use a calculated value or a nominal value for the circumference.*

2. Tightly wrap the layout tape once around the entire pipe and line up the edges. Using the tape as a template guide for marks, mark scribe lines around the entire circumference of the pipe, as shown in Figure 3-13 below.



**Figure 3-13: Marking Circumferential Lines on the Pipe**

3. Line up the zero scale of the layout tape at the desired location of the first transducer. (For a typical installation, this point will be the 3 o'clock position on a horizontal pipe.) Mark each of the two circumferential lines at the zero point. Connect each of these marks using a straight edge (for example, the edge of the layout tape) as shown in Figure 3-14 on the next page.

## Surveying the Pipe (cont.)



**Figure 3-14: Marking the 3 o'clock Position**

4. To find the coinciding point on the opposite site of the pipe ( $180^\circ$  away from each other), divide the measured circumference by 2 and measure this distance along the circumferential lines from the zero point, as shown in Figure 3-15 below. Place marks on both sides of the circumferential lines made with the layout tape and connect the marks.



**Figure 3-15: Marking the 9 o'clock Position**

Make sure to take the  $180^\circ$  point measurement from both over the top of the pipe and under the bottom of the pipe (on a horizontal pipe) to ensure reciprocity of the installation. Figure 3-16 on the next page shows the appropriate way to measure the  $180^\circ$  point.

## Surveying the Pipe (cont.)

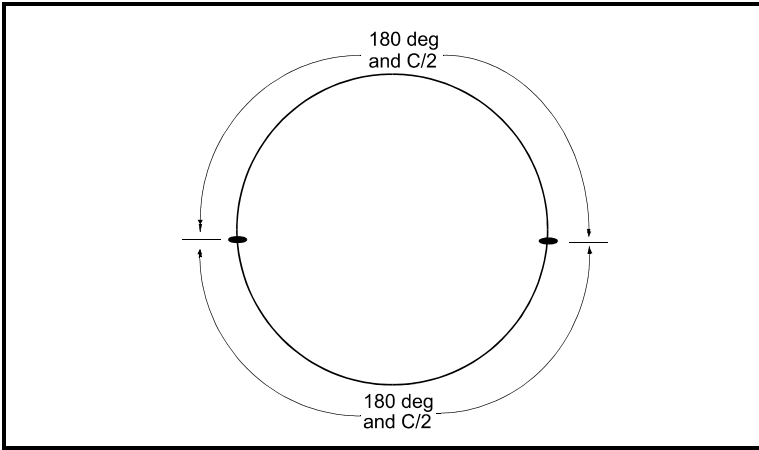

**Figure 3-16: Measuring the 180° Point  
from Top and Bottom**

## Installing the First Bracket with a Chain or Strap

The following steps describe how to install the PI fixture with a supplied chain or strap.

1. Carefully wrap the chain or strap around the pipe, taking care not to twist it.
2. Loosen the wing nuts up to the end of the J-hooks. Then hook the chain into the tightest links and loosely hand tighten the wing nuts. If you are using a strap, insert the J-hook into the smaller round hole on the strap.
3. Line up one edge of the CFG-PI holder bracket with the origin scribe line and fully tighten the chain or strap (see Figures 3-17 and 3-18 below).

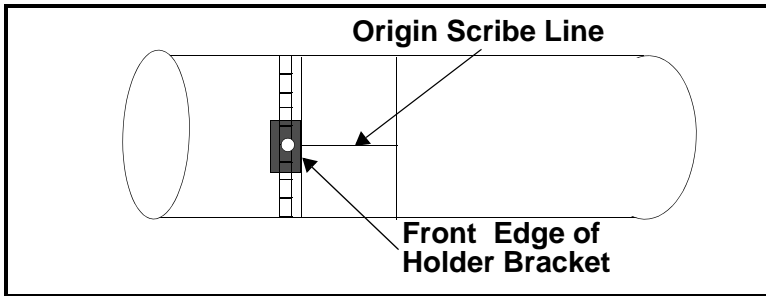

Figure 3-17: Lining up the First Bracket

4. Install the transducer dummy block to verify the circumferential and axial location. Center the indicator line on the block to line up with the scribed mark (see Figure 3-18 below).



Figure 3-18: Positioning the CFG-PI Holder Bracket

5. Loosen the transducer hold-down screw and tighten the J-hooks on the clamping fixture. Be sure the bracket has not moved from its position.



## Installing the Second Bracket with a Chain or Strap

**Note:** *The following step requires the transducer spacing discussed on page 3-7.*

1. Measure the spacing from the zero point (the point of circumferential origin). Mark the spacing point with a crosshair on the opposite side of the pipe, 180° from the zero point (as shown in Figure 3-19 below).

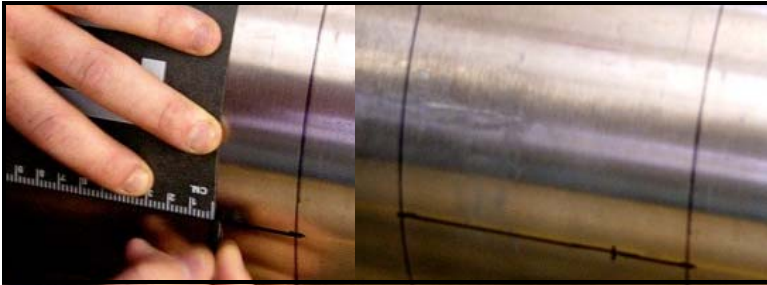

**Figure 3-19: Measuring and Marking Spacing**

2. Carefully wrap the chain or strap around the pipe, taking care not to twist it.
3. Loosen the wing nuts up to the end of the J-hooks. Then hook the chain into the tightest links and firmly hand tighten the wing nuts.
4. Line up the *other* edge of the CFG-PI holder bracket with the scribe line and tighten the chain or strap, as shown in Figure 3-20 below.

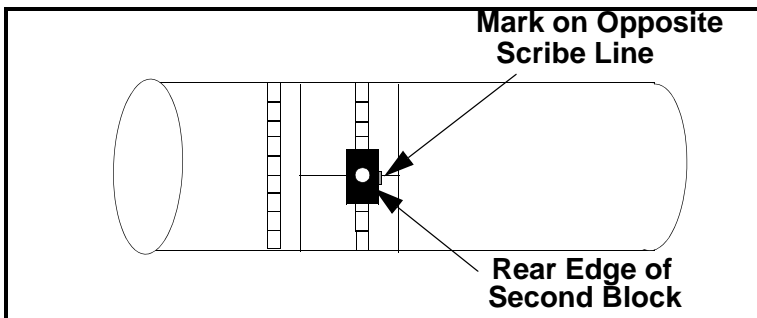

**Figure 3-20: Lining up the Rear Edge of the Bracket with the 180° Scribe Line**

## Installing the Second Bracket (cont.)

The spacing should now appear similar to that shown in Figure 3-21 below.

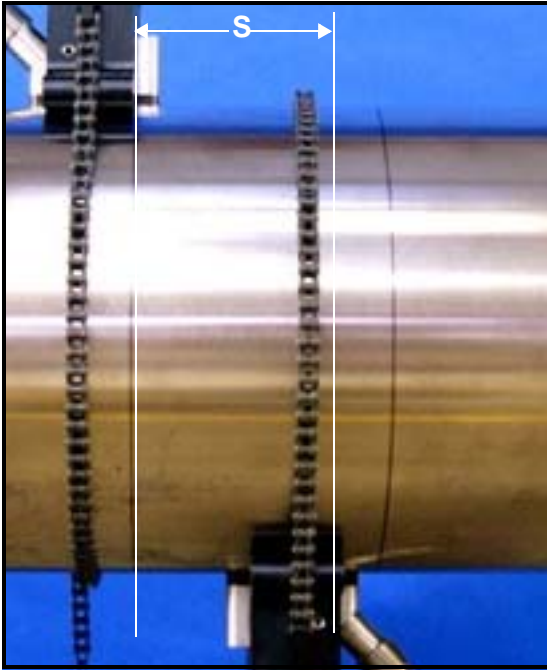

**Figure 3-21: The Installed CFG-PI Fixture, with Calculated Spacing**

## Installing the Transducers

1. Check to be sure the second CFG-PI holder bracket is correctly positioned.
2. Apply a bead of CPL-16 couplant 6 mm (0.25 in.) wide on each transducer face. (See Figure 3-22 below.)

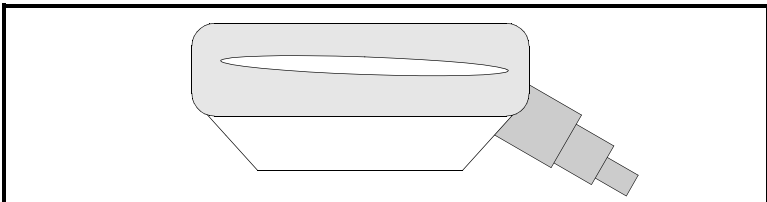

**Figure 3-22: Couplant on Transducer Face**

## Installing the Second Bracket (cont.)

**Note:** *Do not slide the transducer with couplant along the surface of the pipe when mounting the transducer.*

3. With one hand, mount one transducer into the PI fixture. With the other hand, tighten the thumbscrew, gradually pushing the transducer down to the pipe surface. Use a wrench to tighten the backing nut to prevent loosening due to vibration and thermal expansion.

**IMPORTANT:** *Do not use pliers or a wrench on the thumbscrew.*

4. Repeat step 3 for the other transducer.

## Installing Dampening Material

GE Infrastructure Sensing strongly recommends applying DMP dampening material in ALL clamp-on applications to help eliminate signal noise. The material comes in two versions:

- The DMP-1 self-adhesive sheet for applications up to 150°F (66°C). The material comes as two 9.5-in. (24 cm) wide sheets cut in sufficient length to cover the pipe circumference plus an additional tenth of a circumference. The material can be cut with a utility knife, and comes with a paper backing that is removed before installation.
- The DMP-3 is a clay-like compound for all temperature applications. If the temperature is over 150°F, the PDJ pipe dampening jacket (available from GE Infrastructure Sensing with preapplied DMP-3) must be used with the material.

At a minimum, you should consider applying dampening material if you have any of the following conditions:

- The distance from the nearest butt weld or pipe flange is less than 10 ft (3 m);
- The pipe size is under 4 in. (100 mm) diameter and the gas pressure is 200 psig (14 barg) or lower;
- The pipe is deformed,
- The pipe is old, with a history of scaling or rust,
- The pipe experiences condensation on the outside.

**Note:** *Consult a GE Infrastructure Sensing flowmeter applications engineer or sales engineer if you have any questions regarding dampening material.*

## Installing DMP-1 Dampening Material with CFG-V Series Fixtures

1. Be sure the CFG-V clamping fixture is installed on the pipe with the transducers as described in the section *Installing the V Series Clamping Fixture and Transducers* on page 3-8. With a marker, mark scribe lines on the inside edges of the brackets onto the pipe. These lines indicate where to apply the material. (One 9.5-in. roll fits between the brackets.)
2. Remove the fixture and transducers.
3. Use a dry towel or rag and thoroughly dry the pipe.
4. Unroll the DMP-1 material and cut off a length equal to the circumference. Peel the paper backing off the cut portion.

**IMPORTANT:** *The DMP-1 material will only adhere to the pipe correctly if the pipe is completely dry. To adhere properly, the material must also be at a temperature above 50°F (10°C).*

5. Before more atmospheric condensation can occur on the outside of the pipe, roll the DMP-1 dampening material once around the pipe, following the scribe marks that represent the inside edge of the fixture, as shown in Figure 3-23 below.



**Figure 3-23: DMP-1 Dampening Material  
Wrapped Around Pipe**

6. Reinstall the fixture, and make sure the spacing is set correctly. Loosely mount the transducers on top of the dampening material, using the correct spacing.

## Installing DMP-1 Dampening Material with CFG-V Series Fixtures (cont.)

7. With a marker, trace around the transducer footprint, as shown in Figure 3-24 below.



**Figure 3-24: DMP-1 Material with Transducer Footprint Traced**

8. Remove the fixture and transducer. Then use a utility knife to cut out the area under the transducer footprint, and peel the cut material off the pipe, as shown in Figure 3-25 below.

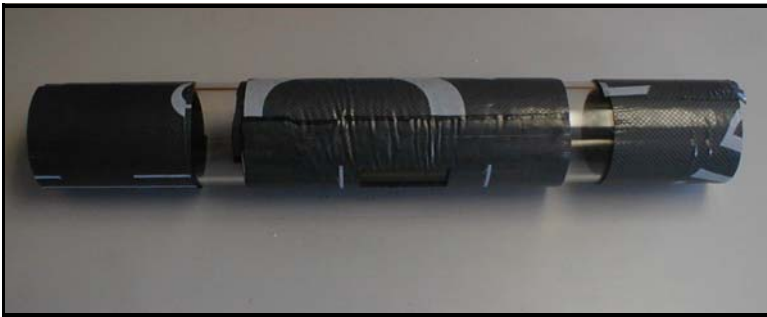

**Figure 3-25: DMP-1 Material with Transducer Footprint Cut Out**

9. To remove any residual adhesive, clean the cut-out area with a rag or a piece of sandpaper.
10. Reinstall the fixture and transducers on the pipe.

## Installing DMP-1 Dampening Material with CFG-V Series Fixtures (cont.)

11. Lay the second strip of dampening material flat. Then cut the strip into two pieces, each 4.5-in. (12 cm) wide.
12. Wrap each of these strips around the pipe on the outside edge of the clamping fixture, one upstream and one downstream. The completed dampening material installation should appear similar to Figure 3-26 below.



**Figure 3-26: Completed DMP-1 Installation**

## Installing DMP-1 Dampening Material with PI Fixture

1. Be sure the PI clamping fixture is installed onto the pipe with the transducers as described in the section *Installing the PI Fixture and Transducers* on page 3-12.
2. Approximate the axial distance from one transducer face to the other transducer face, as shown in Figure 3-27 below.

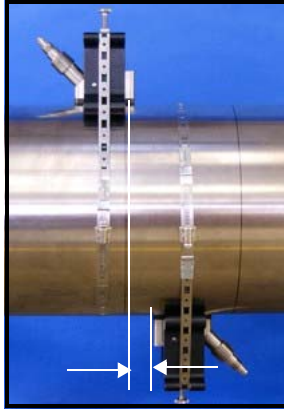

**Figure 3-27: Distance Between Transducer Faces**

3. Lay the first strip of dampening material flat. Cut a strip to a width equal to the distance between transducer faces (the distance illustrated in Figure 3-27 above).
4. Wrap this strip around the pipe in the space between the transducers.
5. Lay the second strip of dampening material flat. Then cut the strip into two pieces, each 4.5-in. (12 cm) wide.
6. Wrap each of these strips around the pipe on the outside edge of the clamping fixture, one upstream and one downstream. The completed installation should appear similar to Figure 3-28 on the next page.



## Installing DMP-1 Dampening Material with PI Fixture

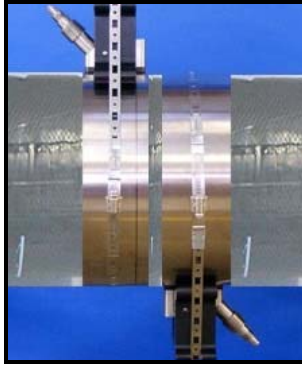
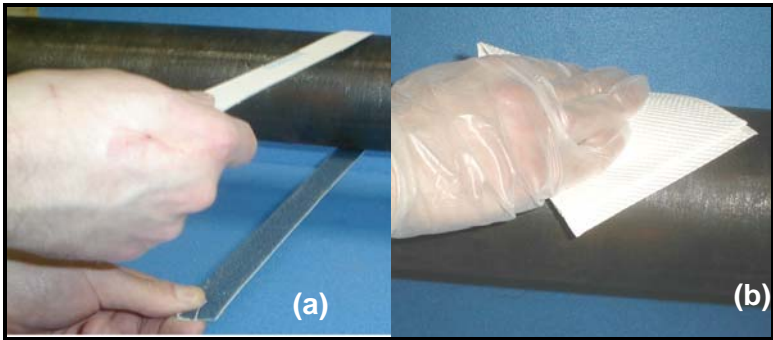

Figure 3-28: Completed DMP-1 Installation

## Installing DMP-3 Compound with All Fixtures

1. Be sure the fixture and transducers are installed on the pipe as described in the previous sections of this chapter.
2. Remove the fixture and transducers, but be sure to mark the approximate area of installation.
3. Remove any loose paint or rust with a file or emery cloth, as shown in Figure 3-29a below. If the finish is mirror-smooth, roughen the surface.



**Figure 3-29: Filing (a) and Degreasing (b) the Pipe Surface**

4. While wearing appropriate gloves, degrease the surface as shown in Figure 3-29b above.
5. Place a piece of the DMP-3 material on top of the pipe (Figure 3-30a), and use the palm of the hand to press it onto the pipe (see Figure 3-30b below).

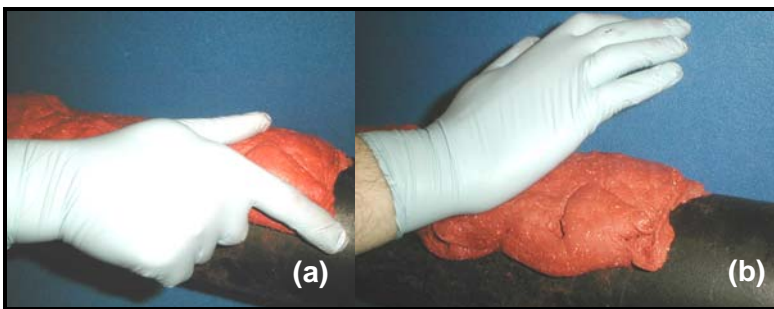

**Figure 3-30: Applying the DMP-3 Material**

## Installing DMP-3 Compound with All Fixtures (cont.)

- Spread the DMP-3 material so that it covers the whole area under the fixture to a thickness of about 0.25 in. (6.4 mm), as shown in Figure 3-31a below.

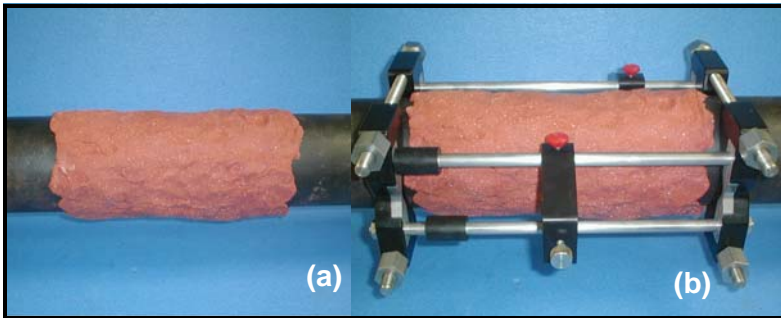

Figure 3-31: Spreading the DMP-3 (a) and Reinstalling the Fixture (b)

- Position the transducer yokes to the correct spacing and reinstall the fixture around, but not on, the DMP-3 material, as shown in Figure 3-31b above.
- Remove the DMP-3 material from the transducer locations (Figure 3-32a below).

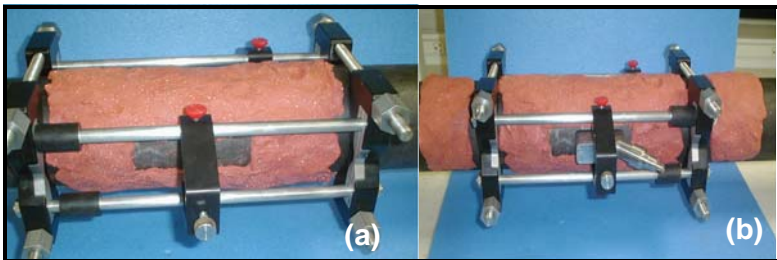

Figure 3-32: Clearing DMP-3 from the Transducer Location (a) and Installing the Transducers (b)

- Apply the couplant to the transducers, and install the transducers onto the pipe.

**Note:** *If the measurement point is near a flange or weld, apply DMP-3 between that structure and the fixture as well.*

## Installing the PDJ Dampening Jacket

If the pipe temperature is over 150°F, you must use the PDJ pipe dampening jacket with preapplied DMP-3. As the dampening material dries out over several hours after installation, its effectiveness increases. The jacket is available in standard pipe sizes from 4 to 12 in. (100 to 300 mm).

1. Remove any insulation from the installation area, as well as any loose paint, rust and high spots from the pipe.
2. Remove the backing paper from the inside of the pipe dampening jacket (shown in Figure 3-33 below).



**Figure 3-33: The PDJ Pipe Dampening Jacket**

3. Install the jacket on the pipe as shown in Figure 3-34 below. Tighten the clamping screws so that some fluid drips from the bottom of the jacket.



**Figure 3-34: Installation of a PDJ Jacket**

## Installing the PDJ Dampening Jacket (cont.)

---

### **!WARNING!**

**The pipe and the dripping fluid will cause severe burns upon contact with bare skin. Also, be sure not to inhale the fumes generated during the DMP-3 curing cycle.**

---

4. Install the fixture over the jacket, adjusting the spacing to match the prestamped transducer holes and PT878GC spacing calculations.
5. Apply a thin bead of CPL-16 couplant. Spread it in a thin layer about 6 mm (0.25 in.) wide on each transducer face.
6. Install the transducers into the yokes, and tighten the hold-down screws until the couplant begins to spread.
7. If you wish, reinstall insulation over the pipe, making sure that the yokes and junction boxes protrude through the insulation.
8. Wait 15 min. for the couplant to cure and finger-tighten the transducer hold-down screws. Do not use pliers or any other tools.
9. Using a wrench, tighten the transducer hold-down screw backing nuts to prevent loosening due to vibration and thermal expansion.

# Chapter 4

## Programming Site Data

---

On the PT878GC, a Program Menu (part of the Main Menu) enables you to enter information that is specific to each site:

- Transducer types and paths
- Pipe materials and linings
- Fluid types
- Standard volume and mass flow parameters
- Skan/Measure parameters
- Analog input and output parameters
- Digital output parameters
- User functions
- Correction factors

For immediate operation, the PT878GC requires only transducer, pipe and fluid data. However, additional information allows you to tailor measurements to your application. Once you have entered this data, you can save it in files and recall these files for later use. The PT878GC can store up to 1 MB of data in the meter at any one time. But through the infrared link, users can store an unlimited number of sites on a PC, and then upload the sites as they are needed.

This chapter covers entering:

- The Program Menu
- Transducer, pipe, and fluid parameters
- Input/output and other setup parameters
- User functions.

## Entering the Program Menu

To enter the Program Menu, press the [MENU] key at the lower right of the PT878GC keypad. The Menu Bar replaces the Status Bar at the top of the screen. Press the [▶] arrow key once to scroll from the Site Menu to the Program Menu. At the Program Menu, press [ENTER]. The screen appears similar to Figure 4-1 below. While following the programming instructions, refer to Figure A-2 on page A-2 of Appendix A, *Menu Maps*

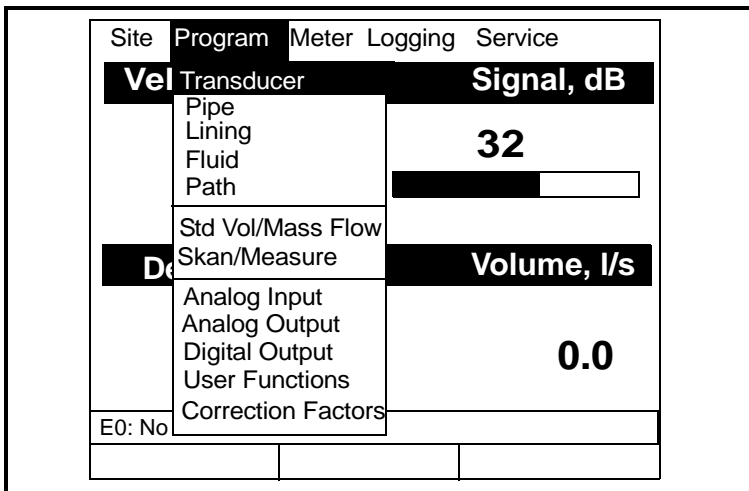

**Figure 4-1: The Program Menu**

To scroll to a particular option, press the [▼] or [▲] arrow keys until you reach the option. Then press [ENTER] to open the option window.

When entering parameters in an option, press:

- The [▼] key to step through the available parameters
- The [▲] key to scroll back to a previously entered parameter
- The [F2] key (Cancel) or the [ESC] key to exit an option at any time and return to Operate Mode without changing the parameters.

**Note:** *On certain text box parameters, you can use the numeric keys to enter a desired value. You can then use the [▲] or [▼] keys to change the value, if necessary.*

## Entering Transducer Parameters

To enter the Transducer option, scroll to the Transducer entry on the Program Menu and press [ENTER]. The screen appears similar to Figure 4-2 below. To step through each parameter (or reach a particular parameter), press the [▼] key. Refer to Figure A-3 on page A-3 of Appendix A, *Menu Maps*

**Note:** Refer to Chapter 3 for additional information about clamp-on gas transducers and fixture configurations.

**Transducer/Pipe**

Transducer | Pipe | Lining | Fluid | Path

Type:  Wetted     Clamp-on

Transducer

Frequency  MHz    Tw  μs

Wedge Ang  °

Wedge Tmp  °C

Wedge SS  m/s

Cancel                      OK

Figure 4-2: The Transducer Option Window

1. The first prompt asks you to select whether you are using a wetted or a clamp-on transducer.
  - a. Use the [◀] and [▶] keys to scroll between the two types.
  - b. Press [ENTER] or [SEL] to confirm the choice.

**IMPORTANT:** While wetted transducers are listed as a choice, the PT878GC is designed for use with Shear wave clamp-on transducers. Consult GE before selecting wetted transducers.



---

## Entering Transducer Parameters (cont.)

**Note:** *The choices made earlier in the Transducer and Pipe options determine the prompts available later. If the PT878GC does not scroll to a particular parameter, it is not necessary for that transducer or pipe type.*

2. The next prompt asks you to enter the transducer number, or to specify that you are using a special application transducer.
  - a. From the Type prompt, press the [▼] key to reach the Transducer prompt, and press [ENTER].
  - b. A drop-down list of transducer numbers opens, if you have selected clamp-on in the previous prompt. Press the [▼] or [▲] keys to scroll to the appropriate number, or scroll to “Special” for a special application transducer. To speed scrolling, you can press the [▶] key to scroll down by a page, or the [◀] key to scroll up by a page.
  - c. Press [ENTER] to confirm your selection.

The program now varies, depending on whether you have selected preprogrammed or special transducers.

- If you have selected a transducer from the list of preprogrammed shear clamp-on transducers (#301 to 315), the PT878GC comes programmed with the needed parameters. You only need to enter the wedge temperature.
  - a. From the Wedge Angle prompt, press the [▼] key to reach the Wedge Temperature prompt, and press [ENTER].
  - b. Use the numeric keys to enter the wedge temperature (in degrees) and press [ENTER].

**Note:** *For highest accuracy, measure the wedge temperature on the transducer wedge.*

Pressing the [▼] key thus returns the meter to the Transducer tab at the top. Go to page 4-7 to continue programming.

- However, if you have selected a special application transducer, turn to the next page.

## Parameters for Special Transducers

3. The prompt asks for the transducer frequency, to transmit a voltage at a rate to which the transducer can respond.
  - a. From the Transducer prompt, press the [▼] key to reach the Frequency prompt, and press [ENTER].
  - b. A drop-down list of five frequencies opens, ranging from 0.25 to 4.00 MHz. Scroll to the frequency of your transducers, and press [ENTER].
4. The next prompt asks for Tw, the time delay. This parameter is actually the time the transducer signal spends travelling through the transducer and cable. The PT878GC calculates the flow rate by subtracting the time of the upstream and downstream signals, so the time delay must be subtracted out for an accurate measurement. GE Infrastructure Sensing supplies the time delay on a data sheet inside the transducer case.
  - a. From the Frequency prompt, press the [▶] key to reach the Tw prompt, and press [ENTER].
  - b. Use the numeric keys to enter the GE Infrastructure Sensing-supplied time delay and press [ENTER].
5. When calculating the flow rate, the PT878GC must take into account the wedge angle, the angle of the ultrasonic transmission.
  - a. From the Tw prompt, press the [▼] key to reach the Wedge Angle prompt, and press [ENTER].
  - b. Use the numeric keys to enter the GE Infrastructure Sensing-supplied wedge angle (in degrees) and press [ENTER].
6. The PT878GC must also take into account the wedge temperature.
  - a. From the Wedge Angle prompt, press the [▼] key to reach the Wedge Temperature prompt, and press [ENTER].
  - b. Use the numeric keys to enter the wedge temperature (in degrees) and press [ENTER].

## Parameters for Special Transducers (cont.)

**Note:** *If the transducer is installed on a pipe that is at a different temperature than the ambient temperature, the wedge temperature is the average of the pipe temperature and the ambient temperature.*

7. Finally, the PT878GC requires the wedge sound speed.
  - a. From the Wedge Temp prompt, press the [▼] key to reach the Wedge SS prompt, and press [ENTER].
  - b. Use the numeric keys to enter the GE Infrastructure Sensing-supplied wedge sound speed (in ft/sec or m/sec) and press [ENTER].

Pressing the [▼] key returns the meter to the Transducer tab at the top.

- To confirm the entries and return to Operate Mode, press [F3] (OK).
- To leave the window without confirming the entries and return to Operate Mode, press [F2] (Cancel) or the [ESC] key.

## Entering Pipe Parameters

To enter the Pipe option, scroll to the Pipe entry on the Program Menu and press [ENTER]. (From the Transducer window, you can scroll back up to the Transducer tab and press the [▶] arrow key to reach the Pipe window and press [ENTER].) The screen appears similar to Figure 4-3 below. To step through each parameter, press the [▼] key. Refer to Figure A-4 on page A-4 of Appendix A, *Menu Maps*.

**Note:** Refer to the brochure *Sound Speeds and Pipe Size Data (914-004)* for additional information about pipe sizes and sound speeds.

The screenshot shows a window titled "Transducer/Pipe" with five tabs: "Transducer", "Pipe", "Lining", "Fluid", and "Path". The "Pipe" tab is selected. The window contains the following fields and controls:

- Material:** A dropdown menu showing "Other".
- SndSpeed:** A text input field containing "600.3" followed by "m/s".
- OD, mm:** A text input field containing "5".
- OD x PI, mm:** A text input field containing "15.708".
- Wall, mm:** A text input field containing "2".
- Nominal:** An empty text input field.
- Schedule:** An empty text input field.
- ANSI:** A checkbox that is currently unchecked.
- Buttons:** "Cancel" and "OK" buttons at the bottom.

Figure 4-3: The Pipe Option Window

## Entering Pipe Parameters (cont.)

1. The first prompt asks you to select the pipe material.
  - a. Press [ENTER] to enter the material prompt.
  - b. A drop-down list of materials opens. Table 4-1 below lists the available preprogrammed materials on the list. Press the [▼] or [▲] keys to scroll to the appropriate material, or scroll to “Other” for a material not on the list. You can press the [▶] key to scroll down by a page, or the [◀] key to scroll up by a page.

**Table 4-1: Preprogrammed Pipe Materials**

Pipe Material Category	Specific Material
Al - Aluminum	Rolled
Brass	None
Cu - Copper	Annealed or Rolled
CuNi - Copper/Nickel	70% Cu 30% Ni or 90% Cu 10% Ni
Glass	Pyrex, Flint, or Crown
Gold	Hard-drawn
Inconel	None
Iron	Armco, Ductile, Cast, Electrolytic
Monel	None
Nickel	None
Plastic	Nylon, Polyethylene, Polypropylene, PVC (CPVC), or Acrylic
Steel	Carbon Steel or Stainless Steel
Tin	Rolled
Titanium	None
Tungsten	Annealed, Carbide, Drawn
Zinc	Rolled
Other	Any material

- c. Press [ENTER] to confirm the choice.

---

## Entering Pipe Parameters (cont.)

2. At this point, the program follows one of two paths:
  - a. If you have selected a preprogrammed material, the PT878GC automatically supplies the correct sound speed, and proceeds to step 3.
  - b. If you have selected “Other,” the meter prompts you to enter the sound speed. Use the numeric keys to type the known sound speed in the text box, and press [ENTER] to confirm the choice.
3. At this point, two alternatives are available. At the Diameter prompt, the meter asks for the pipe outside diameter and thickness. But if you have selected certain pipe materials (carbon or stainless steel, cast iron, PVC and CPVC), you have the option of entering the pipe dimensions by a standardized schedule. Once you enter the nominal pipe size and schedule identification, the PT878GC determines the OD and wall thickness from an internal table.

If you select a material that uses the Diameter alternative:

- a. You must select from two choices, outside diameter or circumference.
  - The prompt moves to the OD (outside diameter) text box. Type the pipe OD (in mm or in.) into the text box, and press [ENTER] to confirm the choice, or
  - Move the prompt to the OD X PI (circumference) text box. Type the circumference (in mm or in.) into the box, and press [ENTER] to confirm your choice.
- b. In either case, the next prompt asks for the wall thickness. Type the value (in mm or in.) into the box, and press [ENTER] to confirm your choice

**Note:** *The measurement units shown depend on the choices you have made in the English/Metric window of the Meter menu.*

## Entering Pipe Parameters (cont.)

If you select a material that has the Schedule option:

- a. The prompt asks if you wish to apply DIN (the DIN schedule). Press [ENTER] to select (or deselect) the DIN box. (If you do not select the DIN option, the prompt moves to the OD text box, and you enter the parameters for the Diameter alternative as discussed on the previous page.)

**Note:** *If you have selected English units in the Meter Menu (as discussed on page 7-3), the schedules appear as ANSI.*

- b. Press the [◀] key twice to move the prompt to the Nominal pipe size drop-down menu. Press [ENTER] to open the menu. Scroll to the desired pipe size, and press [ENTER] to confirm your choice.
- c. Press the [▶] key to move the prompt to the Schedule drop-down menu. Press [ENTER] to open the menu. Scroll to the desired schedule (5S, 10S, 40S or 80S), and press [ENTER] to confirm the choice.

After entering either diameter or schedule settings, pressing the [▲] key returns the meter to the Pipe Material prompt.

- To confirm the entries and return to Operate mode, press [F3] (OK).
- To leave the window without confirming the entries and return to Operate mode, press [F2] (Cancel) or the [ESC] key.
- To return to the Pipe tab and scroll to other windows, press the [▲] key.

## Entering Pipe Lining Parameters

To enter the Lining option, scroll to the Lining entry on the Program Menu and press [ENTER]. (From the Pipe window, you can scroll back up to the Pipe tab and press the [▶] arrow key to reach the Lining window, and press [ENTER].) The screen appears similar to Figure 4-4 below. To step through each parameter, press the [▼] key. While programming, refer to Figure A-3 on page A-3 of Appendix A, *Menu Maps*.

**Note:** *The Lining option is only available for clamp-on transducers.*

The screenshot shows a window titled "Transducer/Pipe" with five tabs: "Transducer", "Pipe", "Lining", "Fluid", and "Path". The "Lining" tab is selected. Below the tabs, the following parameters are displayed:

- Material: **Tar/Epoxy**
- Sound Speed:  m/s
- Thickness:  mm

At the bottom of the window are two buttons: "Cancel" and "OK".

Figure 4-4: The Pipe Lining Window

1. The PT878GC first prompts you to select the pipe lining material.
  - a. Press [ENTER] to open the drop-down list of lining materials.
  - b. Scroll to the appropriate material. If you do not see your lining material on the list, select "Other."
  - c. Press [ENTER] to confirm your choice.



---

## Entering Pipe Lining Parameters (cont.)

**Note:** *If your pipe lining is not on the drop-down list, consult GE Infrastructure Sensing for further information.*

2. The program follows one of two paths:
  - a. If you have selected a preprogrammed material, the PT878GC automatically supplies the correct sound speed, and you proceed to step 3.
  - b. If you have selected “Other,” the meter prompts you to enter the sound speed. Press [ENTER]. Use the numeric keys to type the known sound speed in the text box, and press [ENTER] to confirm the choice.
3. The meter now asks for the lining thickness. Press [ENTER]. Use the numeric keys to enter the known value in the text box, and press [ENTER] to confirm your entry.

Pressing the [▼] key returns the meter to the Lining tab.

- To confirm the entries and return to Operate mode, press [F3] (OK).
- To leave the window without confirming the entries, press [F2] (Cancel) or the [ESC] key.
- To scroll to other windows, press the [◀] or [▶] key.

## Entering Fluid Types and Speeds

To access the Fluid option, scroll to the Fluid entry on the Program Menu and press [ENTER]. (If you are already in the Transducer/Pipe form, press the [▶] arrow key to reach the Fluid window, and press [ENTER].) The screen appears similar to Figure 4-5 below. To step through each parameter, press the [▼] key. Refer to Figure A-3 on page A-3 of Appendix A, *Menu Maps*.

The screenshot shows a window titled "Transducer/Pipe" with a dark header bar. Below the header are five tabs: "Transducer", "Pipe", "Lining", "Fluid", and "Path". The "Fluid" tab is currently selected and highlighted. The main area of the window contains two input fields: "Fluid Type" with the value "Other" and "Sound Speed" with the value "345.75" followed by "m/s". At the bottom of the window are two buttons: "Cancel" and "OK".

Figure 4-5: The Fluid Type Window

1. The first prompt asks for the gas type.
  - a. Press [ENTER] to open the drop-down menu. The following choices are available:
    - Other
    - Air
    - Natural Gas
    - Steam

---

## Entering Fluid Types and Speeds (cont.)

- b. Scroll to the appropriate entry. If you do not see your fluid on the list, select “Other.”
- c. Press [ENTER] to confirm your selection.

If you have selected a preprogrammed gas, the PT878GC supplies the sound speed. Pressing the [▼] key returns you to the Fluid tab. However, if you have selected “Other,” the PT878GC prompts you to enter the sound speed.

- a. Press [ENTER] to open the text box.
- b. Use the numeric keys to enter the known sound speed.
- c. Press [ENTER] to confirm the selection.

Pressing the [▼] key returns you to the Fluid prompt.

- To confirm the entries and return to Operate mode, press [F3] (OK).
- To leave the window without confirming the entries and return to Operate mode, press [F2] (Cancel) or the [ESC] key.

## Entering the Signal Path Parameters

To enter the Path option, scroll to the Path entry on the Program Menu and press [ENTER]. (From the Lining window, you can scroll back up to the Lining tab and press the [▶] arrow key to reach the Path window, and press [ENTER].) The screen appears similar to Figure 4-6 below. To step through each parameter, press the [▼] key. Refer to Figure A-3 on page A-3 of Appendix A, *Menu Maps*.

The screenshot shows a window titled "Transducer/Pipe" with five tabs: "Transducer", "Pipe", "Lining", "Fluid", and "Path". The "Path" tab is selected. Inside the window, there are four input fields with the following values: "Path Length" is 248.92 mm, "Axial Length" is 203.2 mm, "Traverses" is 1, and "Spacing" is 90 mm. At the bottom of the window are two buttons: "Cancel" and "OK".

Figure 4-6: The Signal Path Window

**Note:** *The Path Length and Axial Length parameters are not available for clamp-on transducers.*

## Path Parameters for Clamp-On Transducers

The PT878GC path menu includes two parameters for clamp-on transducers:

- Traverses
  - Spacing
1. The PT878GC first prompts for traverses, the number of times the ultrasonic signal crosses the pipe.
    - a. Press [ENTER] to open the drop-down list of traverse numbers.
    - b. Scroll to the appropriate number.
    - c. Press [ENTER] to confirm the entry.
  2. The next prompt displays the spacing of the transducers, as calculated from the information entered.
    - a. Record this number and use it to space the transducers. (Use Chapter 3 to assist in installing transducers on the pipe.) Press the [▼] key to scroll to the next parameter.
    - b. If necessary, you can overwrite the spacing to match the actual physical spacing of the transducers. (Do not change the spacing by more than  $\pm 10\%$  from that calculated by the meter.) Press [ENTER]. Use the numeric keys to enter the desired value, and press [ENTER] to confirm the entry. If you enter an invalid entry, the PT878GC rejects the entry and displays an error message.

**Note:** *GE Infrastructure Sensing does not recommend using a spacing other than the one calculated by the PT878GC.*

After you enter the spacing, pressing the [▲] key returns the prompt to the Traverses box, and then to the Path tab at the top of the screen.

- To confirm the entries and return to Operate mode, press [F3] (OK).
- To leave the window without confirming the entries and return to Operate mode, press [F2] (Cancel) or the [ESC] key.

## Entering the Standard Volume/ Mass Flow Parameters

The Standard Volume/Mass Flow option enables you to correct standard volumetric units for pressure and temperature, as well as to disable or enable mass flow. To enter this option, scroll to the Std Vol/Mass Flow entry on the Program Menu and press [ENTER]. The screen appears similar to Figure 4-7 below. To step through each parameter, press the [▼] key. Refer to Figure A-5 on page A-5 of Appendix A, *Menu Maps*.

**Std Vol/Mass Flow**

Settings   Inputs   Mass Flow

Standard\_Volume

Enabled       Disabled

Base Pressure  Bars

Atmospheric Pressure  Bars

Base Temperature  °C

Cancel      OK

Figure 4-7: The Standard Volume Option Window

1. The first prompt asks if you want to disable or enable the Standard Volume option.
  - a. Use the [◀] and [▶] keys to scroll to the appropriate radio button.
  - b. Press [ENTER] to confirm your selection.

**Note:** *If you select “Disabled,” you cannot select any other prompts in this window.*

## Entering the Standard Volume Parameters (cont.)

2. The next prompt asks for the base pressure.
  - a. Press [ENTER] to enter the text box.
  - b. Use the numeric keys to enter the known pressure.
  - c. Press [ENTER] to confirm the entry.
3. The next prompt asks for the atmospheric pressure.
  - a. Press [ENTER] to enter the text box.
  - b. Use the numeric keys to enter the local atmospheric pressure.
  - c. Press [ENTER] to confirm the entry.
4. The final prompt in this window asks for the base temperature (in degrees F or C).
  - a. Press [ENTER] to enter the text box.
  - b. Use the numeric keys to enter the known temperature.
  - c. Press [ENTER] to confirm the entry.

Pressing the [▲] key returns the meter to the Standard Volume prompt, and then to the Settings tab.

- To confirm the entries and return to Operate mode, press [F3] (OK).
- To leave the window without confirming the entries and return to Operate mode, press [F2] (Cancel) or the [ESC] key.

## Entering Inputs in the Standard Volume Option

To enter input parameters in the Standard Volume/Mass Flow option, return to the Settings tab at the top of the Standard Volume window. Press the [▶] arrow key and [ENTER] to open the Inputs window. The screen appears similar to Figure 4-8 below. To step through each parameter, press the [▼] key.

The screenshot shows a window titled "Std Vol/Mass Flow" with three tabs: "Settings", "Inputs", and "Mass Flow". The "Inputs" tab is selected. The window is divided into two main sections: "Pressure" and "Temperature".

**Pressure Section:**

- Radio buttons:  Fixed,  Active
- Input fields: Pressure [ 1.01 ] Bars, Input # [ A ]

**Temperature Section:**

- Radio buttons:  Fixed,  Active
- Input fields: Temp [ 15.5 ] °C, Input # [ B ]

At the bottom of the window are two buttons: "Cancel" and "OK".

**Figure 4-8: The Inputs Tab in the Standard Volume/Mass Flow Option**

1. The first prompt asks if the pressure is fixed or active.
  - a. Use the [◀] and [▶] keys to scroll to the appropriate radio button.
  - b. Press [ENTER] to confirm your selection.



## Entering Inputs in the Standard Volume Option (cont.)

2. The next prompt appears if you have selected a fixed pressure. The PT878GC asks for the fixed pressure value.
  - a. Press [ENTER] to open the text box.
  - b. Use the numeric keys to enter the known pressure.
  - c. Press [ENTER] to confirm the entry.
3. Whether you have selected a fixed or an active supply, the PT878GC asks for the desired input.
  - a. From the Pressure text box, press the [▶] arrow key to reach the Input # menu.
  - b. Press [ENTER] to open the drop-down menu.
  - c. Scroll to Input A or B.
  - d. Press [ENTER] to confirm the entry.
4. The next prompt asks if the temperature is fixed or active.
  - a. Use the [◀] and [▶] keys to scroll to the appropriate radio button.
  - b. Press [ENTER] to confirm your selection.
5. The next prompt appears if you have selected a fixed temperature. The PT878GC asks for the fixed temperature value.
  - a. Press [ENTER] to open the text box.
  - b. Use the numeric keys to enter the known temperature (in degrees C or F), and press [ENTER] to confirm the entry.
6. Whether you have selected a fixed or an active temperature, the PT878GC asks for the desired input.
  - a. Press [ENTER] to open the drop-down menu.
  - b. Scroll to Input A or B.
  - c. Press [ENTER] to confirm the entry.

## Entering Inputs in the Standard Volume Option (cont.)

**Note:** *If you have switched both active inputs to #A (or to #B), the PT878GC automatically switches one input to the other letter. This change ensures that only one analog input is assigned to one measurement type.*

Pressing the [▼] key returns the meter to the Inputs tab.

- To confirm the entries and return to Operate Mode, press [F3] (OK).
- To leave the window without confirming the entries and return to Operate mode, press [F2] (Cancel) or the [ESC] key.

## Entering Mass Flow Parameters

To enter mass flow parameters in the Standard Volume/Mass Flow option, press the [▶] arrow key until you reach the Mass Flow tab, and then press [ENTER] to open the Mass Flow window. The screen appears similar to Figure 4-9 below. To step through each parameter, press the [▼] key.

The screenshot shows a window titled "Std Vol/Mass Flow" with three tabs: "Settings", "Inputs", and "Mass Flow". The "Mass Flow" tab is active. Inside the window, there is a section for "Mass Flow" with two radio buttons: "Enabled" (selected) and "Disabled". Below this are three input fields: "Calculation Method" with "Static Density", "Saturated Steam Input" with "Temperature", and "Static Density" with "1.02305" and "Kgs/m3". At the bottom of the window are two buttons: "Cancel" and "OK".

Figure 4-9: The Mass Flow Tab in the Standard Volume/Mass Flow Option

1. The first prompt asks if you want to disable or enable the Mass Flow option.
  - a. Use the [◀] and [▶] keys to scroll to the appropriate radio button.
  - b. Press [ENTER] to confirm your selection.

**Note:** *If you select “Disabled,” you cannot select any other prompt in this window.*

## Entering Mass Flow Parameters (cont.)

2. If you have enabled Mass Flow, the next prompt asks for the calculation method. Three options are available: static density, saturated steam, and steam.
  - a. Press [ENTER] to open the drop-down menu.
  - b. Scroll to the appropriate method for your application.
  - c. Press [ENTER] to confirm the entry.
    - *If you select Saturated Steam:*  
The prompt asks for the Saturated Steam input. Press [ENTER], scroll to either Temperature or Pressure, and press [ENTER].
    - *If you select StaticDensity:*  
The prompt asks for the Static Density value. Press [ENTER] to open the text box, enter the appropriate value, and press [ENTER] to confirm the entry.

Pressing the [▲] key returns the meter to the Mass Flow prompt, and then to the Mass Flow tab.

- To confirm the entries and return to Operate mode, press [F3] (OK).
- To leave the window without confirming the entries and return to Operate mode, press [F2] (Cancel) or the [ESC] key.

## Entering Skan/Measure Parameters

**IMPORTANT:** *Do not change the Skan/Measure parameters unless recommended by GE Infrastructure Sensing.*

If you select one of the Skan/Measure modes in the Measurement mode window in the Signal Setup option (see page 9-24), the PT878GC requires you to set up the appropriate parameters. You can enter this option in either of two ways:

- From the Program Menu, scroll to the Skan/Measure option and press [ENTER], or
- From the Measurement Mode window (page 8-13), select the method, press [ENTER], press the [▼] key to reach the Skan/Measure Setup prompt, and press [ENTER] again.

In either case, the screen appears similar to Figure 4-10 below. To step through each parameter, press the [▼] key. Refer to Figure A-6 on page A-6 of Appendix A, *Menu Maps*.

Skan/Measure			
All	Integrate	Count	Correlate
% of Peak		80	
SkanT Offset		12.6	μs
M>S Switch		5	μs
<input type="checkbox"/> Limit Meas Delta		4	μs
Advanced			
Cancel		OK	

Figure 4-10: The Skan/Measure Setup Option

---

## Entering Skan/Measure Parameters (cont.)

1. The first prompt asks for the Percent of Peak, which is used to calculate the transit times and Delta-T. The default value is 80, and values from 1 to 100 are acceptable.
  - a. Press [ENTER] to enter the text box.
  - b. Use the numeric keys to enter the recommended value.
  - c. Press [ENTER] to confirm the entry.
2. The next prompt asks for Skan-T Offset, a time measurement offset that compensates for any shift resulting from cross-correlation. The default value is 12.6  $\mu\text{sec}$ , and values from -500 to 500  $\mu\text{sec}$  are acceptable.
  - a. Press [ENTER] to enter the text box.
  - b. Use the numeric keys to enter the recommended value.
  - c. Press [ENTER] to confirm the entry.
3. The next prompt, M>S Switch, causes the meter to switch from Skan to Measure Mode when Delta-T is less than the M>S Switch value. The default value is 5.0  $\mu\text{sec}$  and values from 0 to 250  $\mu\text{sec}$  are acceptable.

**Note:** *Do not change this value without consulting GE Infrastructure Sensing. If you wish to use Skan only, set the M/S Switch to a value of 0.*

- a. Press [ENTER] to enter the text box.
  - b. Use the numeric keys to enter the recommended value.
  - c. Press [ENTER] to confirm the entry.
4. The program now asks if you wish to Limit the Measurement Delta. (The default is unchecked or off.)
  - a. Press [ENTER] to enter the text box.
  - b. Use the numeric keys to enter the recommended value in  $\mu\text{sec}$ .
  - c. Press [ENTER] to confirm the entry.

## Entering Skan/Measure Parameters (cont.)

Pressing the [▼] key highlights the Advanced prompt. To enter advanced parameters for the Skan/Measure modes, press [ENTER]. The screen now appears similar to Figure 4-11 below. In each case, to enter a value:

- a. Press [ENTER] to enter the text box.
- b. Use the numeric keys to enter the value.
- c. Press [ENTER] to confirm the entry.

The screenshot shows a window titled "Advanced Signal Setup" with a sub-header "Skan/Meas". Inside the window, there are six input fields with their respective values and units:

Parameter	Value	Unit
# of Shifts	3	
T Window	1	cycles
R Window	10	cycles
Meas Window	10	cycles
Noise Window Width	3	
Noise Window Offset	0	cycles

At the bottom of the window, there are two buttons: "Cancel" and "OK".

Figure 4-11: The Advanced Skan/Measure Window

5. The first prompt, the number of shifts, corresponds to the actual number of transmits per cycle (the number of signals added together in one direction to produce an averaged signal for one interrogation of the fluid). It need only be changed if the environment is very noisy or the acoustic signal is weak. The default value is 3 and values from 0 to 10 are acceptable.

---

## Entering Skan/Measure Parameters (cont.)

6. The next prompt enables you to reset the size of the transmit window. Normally, the PT878GC calculates the size of both transmit and receive windows based on pipe size and fluid sound speed. However, for special diagnostic purposes, it may sometimes be necessary to reset the window size. The default value is 1 and values from 0 to 1,000 are acceptable.
7. The next prompt enables you to reset the size of the receive window for diagnostic purposes. The default value is 10 and values from 0 to 300 are acceptable.
8. The Meas Window prompt allows you to customize the width of the measurement window. While this window is normally 10 cycles wide, the option allows you to customize the width from 1 to 60.

Pressing the [▼] key returns the meter to the # Shifts entry.

- To confirm the entries and return to Operate mode, press [F3] (OK).
- To leave the window without confirming the entries and return to Operate mode, press [F2] (Cancel) or the [ESC] key.



## Entering Skan/Measure Integrate Parameters

To enter parameters for the Skan/Measure Integrate mode in the Skan/Measure option, press the [▶] arrow key once to reach the Integrate tab. Then press [ENTER] to open the Integrate window, which appears similar to Figure 4-12 below.

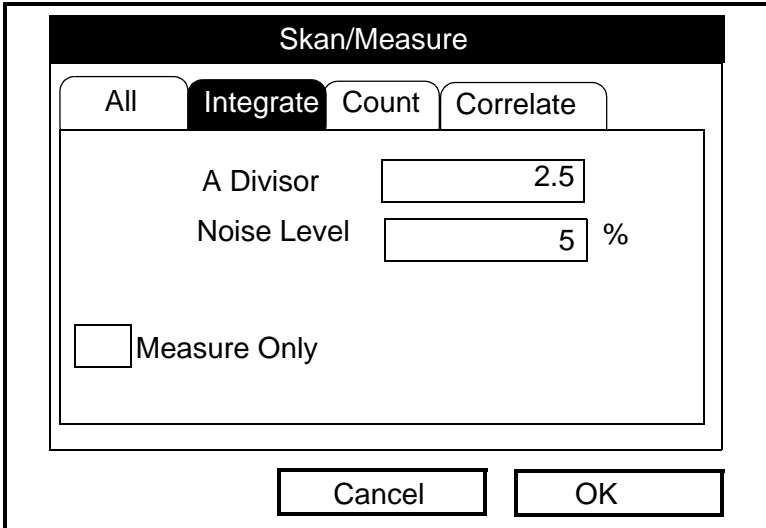

**Figure 4-12: The Integrate Window in the Skan/Measure Option**

1. The first prompt, A Divisor, is used in the calculation of the Measure Mode integrated threshold level and is not normally changed. The default value for this parameter is 2.5, and values from 0.1 to 10 are acceptable.
  - a. Press [ENTER] to enter the text box.
  - b. Use the numeric keys to enter the recommended value.
  - c. Press [ENTER] to confirm the entry.
2. Next, enter the Noise Level ( *-Offset % of Peak*) from 0 to 95%, and press [ENT]. (The default value is 20%.)
  - a. Press [ENTER] to enter the text box.
  - b. Use the numeric keys to enter the recommended value.
  - c. Press [ENTER] to confirm the entry.

## Entering Skan/Integrate Parameters (cont.)

3. If you wish to use Measure Times only (instead of both Skan and Measure times), press [ENTER] at the Measure Only prompt. (You can also press [ENTER] to deselect the prompt.)

Pressing the [▼] key returns the meter to the A Divisor entry, and pressing the [▲] key returns the meter to the Integrate tab.

- To confirm the entries and return to Operate mode, press [F3] (OK).
- To leave the window without confirming the entries and return to Operate mode, press [F2] (Cancel) or the [ESC] key.

## Entering Skan/Measure Count Parameters

To open the Skan/Measure Count window in the Skan/Measure option, press the [▶] arrow key twice (from the All tab) to reach the Count tab. Press [ENTER], and the screen appears similar to Figure 4-13 below.

The screenshot shows a window titled "Skan/Measure" with four tabs: "All", "Integrate", "Count", and "Correlate". The "Count" tab is selected. Below the tabs, there are several input fields and checkboxes:

- Cycle Number:
- Cycle Width:
- Noise Level:  %
- Measure Only
- SNR Test
- Minimum Noise Level:  %
- Low SNR Error Level:

At the bottom of the window are two buttons: "Cancel" and "OK".

Figure 4-13: The Count Window in the Skan/Measure Option

1. The first prompt asks for the Cycle Number *that triggers the count* from 1 to 100. (The default number is 1.)
  - a. Press [ENTER] to enter the text box.
  - b. Use the numeric keys to enter the recommended number.
  - c. Press [ENTER] to confirm the entry.
2. The meter now asks for the Cycle Width (# of cycle count samples, minimum width of valid cycle).
  - a. Press [ENTER] to enter the text box.
  - b. Use the numeric keys to enter the recommended value.
  - c. Press [ENTER] to confirm the entry.

## Entering Skan/Measure Count Parameters (cont.)

3. The next prompt asks for the percentage of Noise Level.
  - a. Press [ENTER] to enter the text box.
  - b. Use the numeric keys to enter the recommended value.
  - c. Press [ENTER] to confirm the entry.
4. If you wish to select (or deselect) Measure Times only (instead of both Skan and Measure times), press [ENTER] at the Measure Only prompt.
5. If you wish to select (or deselect) a SNR (signal-to-noise ratio) test, press the [▶] key to highlight the SNR Test prompt and press [ENTER].
  - a. If you have selected SNR Test, the next prompt asks for the Minimum Noise Level. Press [ENTER], type in the recommended value, and press [ENTER] to confirm the entry.
  - b. The final prompt asks for the Low SNR Error Limit. (The default is 7.) Press [ENTER], type in the recommended value, and press [ENTER] to confirm the entry.

Pressing the [▼] key returns the meter to the Cycle Number entry, and pressing the [▲] key returns the meter to the Count tab.

- To confirm the entries and return to Operate mode, press [F3] (OK).
- To leave the window without confirming the entries and return to Operate mode, press [F2] (Cancel) or the [ESC] key.

## Entering Skan/Correlation Parameters

To open the Skan/Correlation window in the Skan/Measure option, press the [▶] arrow key three times (from the All tab) to reach the Correlate tab, and press [ENTER]. The screen appears similar to Figure 4-14 below.

The screenshot shows a window titled "Skan/Measure" with four tabs: "All", "Integrate", "Count", and "Correlate". The "Correlate" tab is active. Below the tabs, there are three input fields: "Min Threshold" with a value of "-100 %", "Max Threshold" with a value of "100 %", and "Percent Peak" with a value of "-40 %". Below these fields is a checkbox labeled "Measure Only" which is currently unchecked. At the bottom of the window are two buttons: "Cancel" and "OK".

**Figure 4-14: The Correlate Window in the Skan/Measure Option**

To identify the peak of the received signal, the PT878GC uses the “Threshold” method, in which the peak is identified as the point where the signal crosses a threshold that is a percentage of the maximum signal detected.

1. The first prompt, Min Threshold, asks for the minimum percentage of peak used to measure transit time.
  - a. Press [ENTER] to enter the text box.
  - b. Use the numeric keys to enter the recommended value.
  - c. Press [ENTER] to confirm the entry.

## Entering Skan/Correlation Parameters (cont.)

2. Repeat step 1 to enter the maximum percentage of peak.
3. The next prompt asks for the Percent of Peak, which is used to calculate the transit times and Delta-T.
  - a. Press [ENTER] to enter the text box.
  - b. Use the numeric keys to enter the desired value.
  - c. Press [ENTER] to confirm the entry.
4. To select (or deselect) Measure Times only (instead of both Skan and Measure times), press [ENTER] at the Measure Only prompt.

Pressing the [▼] key returns the meter to the Min Threshold entry, and pressing the [▲] key returns the meter to the Correlate tab.

- To confirm the entries and return to Operate mode, press [F3] (OK).
- To leave the window without confirming the entries and return to Operate mode, press [F2] (Cancel) or the [ESC] key.

## Entering Analog Inputs

The Analog Inputs option enables you to specify parameters for general purpose or standard volume inputs. To enter the Analog Inputs option, scroll to the Analog Inputs entry on the Program Menu and press [ENTER]. If you have not enabled the Standard Volume Option (see page 4-18), the screen appears similar to Figure 4-15 below. To step through each parameter, press the [▼] key. Refer to Figure A-6 on page A-6 of Appendix A, *Menu Maps*.

### Entering General-Purpose Analog Inputs

The screenshot shows a window titled "Analog Input" with two tabs, "Input A" and "Input B". The "Input A" tab is active. Inside the window, there are several fields for configuration:
 

- Function:** A dropdown menu currently showing "General Purpose".
- Label:** An empty text input field.
- Units:** An empty text input field.
- Zero:** A text input field containing the number "0".
- Span:** A text input field containing "100", followed by the unit "Psia".

 At the bottom of the window are two buttons: "Cancel" and "OK".

Figure 4-15: The Analog Inputs Option Window

1. The first prompt asks you to select whether the desired function is off or general purpose.
  - a. Press [ENTER] to open the drop-down menu.
  - b. Scroll to the desired response.
  - c. Press [ENTER] to confirm your selection.

**Note:** *If you select "Off," you cannot select any other prompts in this window.*

## Entering General-Purpose Analog Inputs (cont.)

2. The next prompt asks you to create a label for the input. The label corresponds to the measurement type (i.e., velocity or temperature), while the units symbol corresponds to the measurement units (i.e., feet/sec or degrees F).
  - a. Press [ENTER] to open the text creation window, which appears similar to Figure 4-16 below.

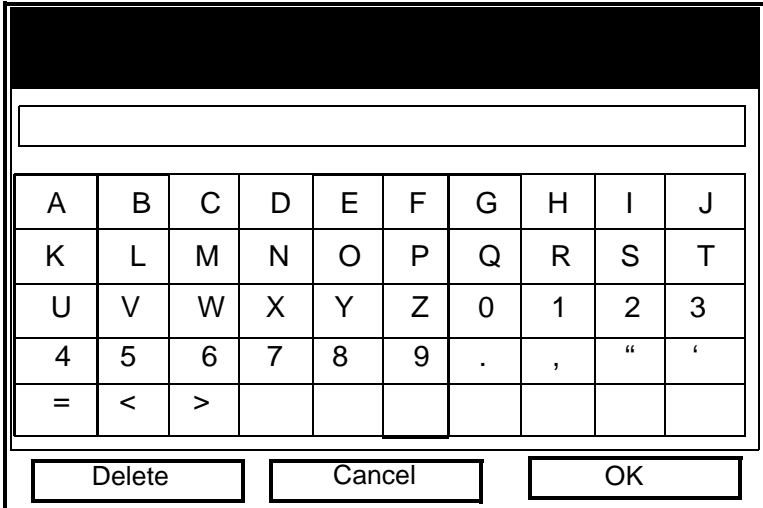

**Figure 4-16: The Text Creation Window**

- b. Use the four arrow keys to scroll to the desired letter or symbol, and press [ENTER] to add the letter to the label.
- Note:** *Pressing [SEL] causes the screen to alternate between a set of upper-case (capital) letters, a set of lower-case letters, and a set of symbols. Use all three screens to create a desired label.*
- c. Repeat this procedure for each letter or symbol you wish to add to the label. If you wish to delete a letter, press [F1] (Delete) to erase each letter or symbol, from right to left on the label. (The label window can display up to 14 characters.)
    - d. When you have completed the label, press [F3] (OK) to confirm the label, or [F2] (Cancel) to leave the window without adding the label.



## Entering General-Purpose Analog Inputs (cont.)

3. The next prompt asks for the Units Symbol.
  - a. Press [ENTER] to reopen the text creation window.
  - b. Repeat the procedure used for the Label (on the previous page) to create the Units Symbol.
  - c. When you have completed the entry, press [F3] (OK) to confirm the symbol, or [F2] (Cancel) to leave the window without adding the symbol. If you confirm the symbol, the Units symbol will appear to the right of the zero and span text boxes.
4. The next prompt asks for the zero input value.
  - a. Press [ENTER] to enter the text box.
  - b. Use the numeric keys to enter the desired value.
  - c. Press [ENTER] to confirm the entry.
5. The final prompt asks for the span input value.
  - a. Press [ENTER] to enter the text box.
  - b. Use the numeric keys to enter the desired value.
  - c. Press [ENTER] to confirm the entry.

You have completed entering data for general-purpose inputs.

## Entering Analog Inputs in Standard Volume or Mass Flow Option

If you have enabled the Standard Volume or Mass Flow options, the screen displays different options, as shown in Figure 4-17 below.

The screenshot shows a window titled "Analog Input" with two tabs, "Input A" and "Input B". The "Input A" tab is active. Inside the window, there are five rows of configuration options, each with a text box and a label:

- Function: Pressure
- Label: Pressure
- Units: Psia
- Zero: 0 Psia
- Span: 100 Psia

At the bottom of the window are two buttons: "Cancel" and "OK".

**Figure 4-17: The Analog Inputs Option Window, with the Standard Volume Option Activated**

1. The screen displays the function (pressure or temperature), label (pressure or temperature) and units selected in the Inputs form of the Standard Volume option (see page 4-20). You cannot change these parameters in this form. Press the [▼] key to step through these parameters.
2. The first prompt asks for the zero input value.
  - a. Press [ENTER] to enter the text box.
  - b. Use the numeric keys to enter the desired value.
  - c. Press [ENTER] to confirm the entry.
3. The final prompt asks for the span input value.
  - a. Press [ENTER] to enter the text box.
  - b. Use the numeric keys to enter the desired value.
  - c. Press [ENTER] to confirm the entry.

## **Entering Analog Inputs in the Standard Volume or Mass Flow Option (cont.)**

You have completed entering parameters in the Analog Inputs option.

- To confirm the entries and return to Operate mode, press [F3] (OK). The PT878GC returns to Operate Mode.
- To leave the window without confirming the entries and return to Operate mode, press [F2] (Cancel) or the [ESC] key.

## Entering the Analog Output

The Analog Output option enables you to enter information to set up output parameters. To enter the option, scroll to the Analog Output entry on the Program Menu and press [ENTER]. The screen appears similar to Figure 4-18 below. To step through each parameter, press the [▼] key. Refer to Figure A-6 on page A-6 of Appendix A, *Menu Maps*.

Analog Output	
Function	0-20 mA
Data Source	Velocity m/s
Zero	0
Span	25.5
On Error	Hold Last Value
<input type="button" value="Cancel"/> <input type="button" value="OK"/>	

Figure 4-18: The Analog Output Window

1. The first prompt enables you to select a range to send a current signal to a recording device.
  - a. Press [ENTER] to open the drop-down menu.
  - b. Scroll to the desired output from three choices: Off, 0-20 mA, and 4-20 mA.
  - c. Press [ENTER] to confirm your selection.

**Note:** *If you select “Off,” you cannot access any other parameters in this option.*

## Entering the Analog Output (cont.)

2. The next prompt asks you to select the analog output type from a number of choices, as shown in Figure 4-19 below.

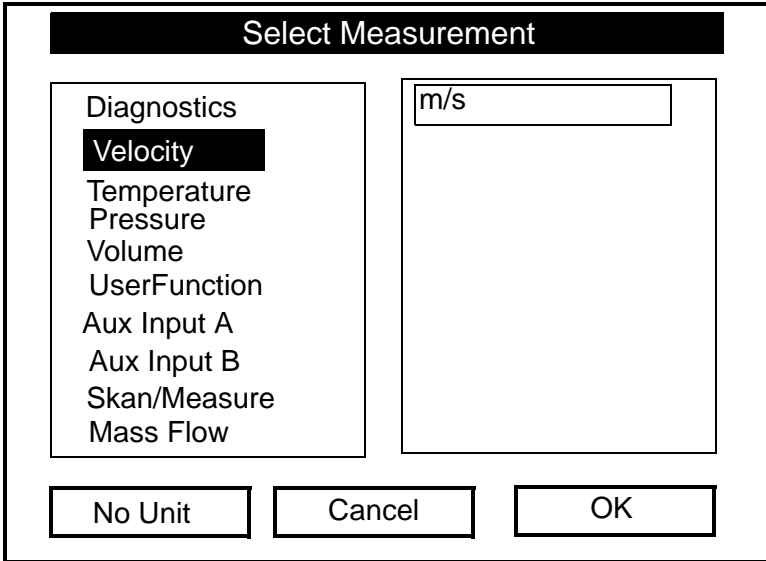

**Figure 4-19: Data Source Selection Window**

- a. Press [ENTER] to open the window.
- b. Scroll to the desired output type.
- c. Press [SEL] to confirm your selection.
- d. The prompt then moves to a list of unit types. (The available units depend on the selection made at the Data Source prompt.) Scroll to the desired output unit.
- e. Press [F3] (OK) to confirm your selection.

---

## Entering the Analog Output (cont.)

3. The next prompt asks you to enter the zero (base) value for the analog output. This value represents the 0/4 mA output (in flow units).
  - a. Press [ENTER] to open the text box.
  - b. Use the numeric keys to enter the desired value.
  - c. Press [ENTER] to confirm your selection.
  
4. The next prompt asks you to enter the span (full scale) value for the analog output. This value represents the 20 mA output (in flow units).
  - a. Press [ENTER] to open the text box.
  - b. Use the numeric keys to enter the desired value.
  - c. Press [ENTER] to confirm your selection.
  
5. The last prompt, On Error, asks you to select how the PT878GC will handle the analog outputs in the event of a fault condition. The meter offers three alternatives:
  - Hold Last Value (hold the last good reading)
  - Force Low (force the reading to 0 or 4 mA)
  - Force High (force the reading to 20 mA).
  - a. Press [ENTER] to open the drop-down menu.
  - b. Scroll to the desired selection.
  - c. Press [ENTER] to confirm your selection.

You have completed entering data in the Analog Output option.

- To confirm the entries and return to Operate mode, press [F3] (OK).
- To leave the window without confirming the entries, press [F2] (Cancel) or the [ESC] key.

---

## Entering the Digital Output

While resembling the Analog Output option, the Digital Output option enables you to set up parameters necessary for a digital output. To enter the option, scroll to the Digital Output entry on the Program Menu and press [ENTER]. The screen appears similar to Figure 4-20 below. To step through each parameter, press the [▼] key. Refer to Figure A-7 on page A-7 of Appendix A, *Menu Maps*.

**Digital Output**

Function

Data Source

Units/Pulse  m<sup>3</sup>

Pulse Width  µs

Polarity

Figure 4-20: The Digital Output Window

1. The first prompt enables you to select the output function from five choices:
  - Off
  - Pulse Totalizer
  - Frequency
  - Test Points
  - Gate Input

---

## Entering the Digital Output (cont.)

- a. Press [ENTER] to open the drop-down menu.
- b. Scroll to the desired function.
- c. Press [ENTER] to confirm your selection.

**Note:** *If you select Off, you will not be able to access any other parameters in this option. If you select Test Points or Gate Input, the program goes at once to Step 4.*

2. The next prompt asks you to select the data source for the digital output from a number of choices. If you select Pulse Totalizer, the meter offers four sources:

- Forward Totalizer
- Reverse Totalizer
- Standard Forward Totalizer
- Standard Reverse Totalizer

If you select Frequency, the sources also include:

- Pressure
- Diagnostics
- Velocity
- Temperature
- Volume
- User Function
- Skan/Measure
- Mass Flow

- a. Press [ENTER] to open the data source selection window, shown in Figure 4-19 on page 4-40.
- b. Scroll to the desired source.
- c. Press [SEL] to confirm your selection.



## Entering the Digital Output (cont.)

- d. The prompt then moves to a list of unit types. (The available units depend on the selection made at the Data Source prompt.) Scroll to the desired output unit.
  - e. Press [F3] (OK) to confirm your selection.
3. The last set of parameters that appears depends on the selection you made at the Function prompt.

*If you selected Pulse Totalizer:*

The prompt asks for the units/pulse, the pulse width (in microseconds), and the polarity. (Figure 4-20 on page 4-42 illustrates a Digital Output window configured for the Pulse Totalizer function.) For the Units/Pulse and Pulse Width parameters:

- a. Press [ENTER] to open the text box.
- b. Use the numeric keys to enter the desired value.
- c. Press [ENTER] to confirm your selection.

For Polarity:

- a. Press [ENTER] to open the drop-down menu.
- b. Scroll to the desired polarity, either Low/High or High/Low.
- c. Press [ENTER] to confirm your selection.

*If you selected Frequency:*

The prompt asks for the minimum and maximum range of measurements, frequencies and the duty cycle percentage. For each parameter:

- a. Press [ENTER] to open the text box.
- b. Use the numeric keys to enter the desired value. (Once you have entered a number, you can use the [▲] or [▼] key to step through to the desired value.)
- c. Press [ENTER] to confirm your selection.
- d. For the minimum and maximum values, press the [▶] key to move to the box to the right, and repeat the procedure.

---

## Entering the Digital Output (cont.)

*If you entered Test Points:*

The prompt asks for the signal type from two choices: transmit or receive.

- a. Press [ENTER] to open the drop-down menu.
- b. Scroll to the required signal.
- c. Press [ENTER] to confirm your selection.

*If you entered Gate Input:*

1. The first prompt asks for the gate active.
  - a. Press [ENTER] to open the drop-down menu.
  - b. Scroll to the gate, either Contact Open or Contact Closed.
  - c. Press [ENTER] to confirm your selection.
2. The remaining prompt asks for the mode, automatic or manual.
  - a. Press [ENTER] to open the drop-down menu.
  - b. Scroll to the required mode.
  - c. Press [ENTER] to confirm your selection.

### Stopwatch Totalizer

Through the Gate Input option, you can implement the Stopwatch Totalizer function to measure totals manually. To set up the Totalizer function:

1. At the Gate Active prompt, select Contact Closed.
2. At the Mode prompt, select Manual, and press [ENTER].

The stopwatch icon (see page 2-11) appears in the system tray. To start or stop the function, press the minus (-) key on the keypad.

You have completed entering parameters in the Digital Output option.

- To confirm the entries and return to Operate mode, press [F3] (OK).
- To leave the window without confirming the entries, press [F2] (Cancel) or the [ESC] key.

---

## Entering User Functions

User functions enable you to perform mathematical equations on each measurement. You can also use any parameter in the meter to calculate a different parameter. To enter the User Functions option, scroll to the User Functions entry on the Program Menu and press [ENTER]. The screen appears similar to Figure 4-21 below. To step through each parameter, press the [▼] key. Refer to Figure A-7 on page A-7 of Appendix A, *Menu Maps*.

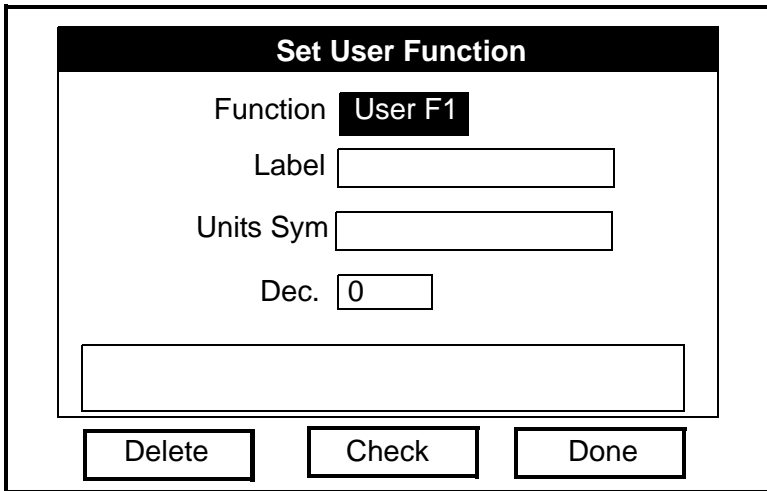

The screenshot shows a window titled "Set User Function". The window contains the following elements:

- Function:** A dropdown menu currently displaying "User F1".
- Label:** An empty text input field.
- Units Sym:** An empty text input field.
- Dec.:** A text input field containing the number "0".
- Buttons:** Three buttons are located at the bottom of the window: "Delete", "Check", and "Done".

Figure 4-21: The User Functions Window

1. The first prompt asks you to select the function number, 1 through 8.
  - a. Press [ENTER] to open the drop-down menu.
  - b. Scroll to the desired function number (User F1, User F2, etc.).
  - c. Press [ENTER] to confirm the entry.

## Entering User Functions (cont.)

2. The next prompt asks you to create a label for the function. The label corresponds to the measurement type (i.e., velocity or temperature), while the units symbol corresponds to the measurement units (i.e., feet/sec or degrees F).
  - a. Press [ENTER] to open the text creation window, which appears similar to Figure 4-22 below.

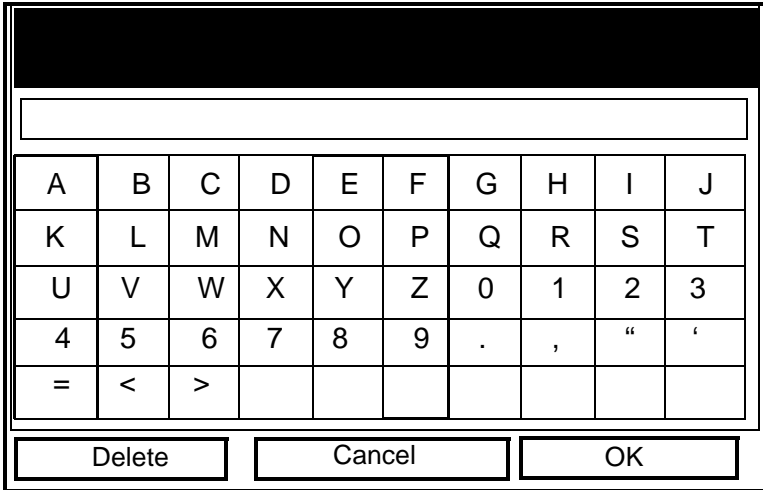

Figure 4-22: The Text Creation Window

- b. Use the four arrow keys to scroll to the desired letter or symbol, and press [ENTER] to add the letter to the label.
- Note:** *Pressing [SEL] causes the screen to alternate between a set of upper-case (capital) letters, a set of lower-case letters, and a set of symbols. Use all three screens to create a desired label.*
- c. Repeat this procedure for each letter or symbol you wish to add to the label. If you wish to delete a letter, press [F1] (Delete) to erase each letter or symbol, from right to left on the label. Up to 17 characters can appear in the label window.
    - d. When you have completed the label, press [F3] (OK) to confirm the label, or [F2] (Cancel) to leave the window without adding the label.

## Entering User Functions (cont.)

3. The next prompt asks for the Units Symbol.
  - a. Press [ENTER] to reopen the text creation window.
  - b. Repeat the procedure used for the Label (on the previous page) to create the Units Symbol.
  - c. When you have completed the entry, press [F3] (OK) to confirm the symbol, or [F2] (Cancel) to leave the window without adding the symbol.
4. The next prompt asks you to select the number of decimal places.
  - a. Press [ENTER] to open the drop-down menu.
  - b. Scroll to the desired number of decimal places, ranging from 0 to 4.
  - c. Press [ENTER] to confirm the entry.
5. The final prompt asks for the function itself.
  - a. Press [ENTER] to open the function creation window, which appears similar to Figure 4-23 on the next page.
  - b. Use the four arrow keys to scroll to the desired function or table, and press [ENTER] to confirm each entry. Use the numeric keys to enter numeric values. Press [F1] (Delete) to remove any mistaken or unwanted symbols or numbers.

**Note:** *Pressing [SEL] causes the screen to alternate between a set of symbols and functions and a list of user functions. Use both screens to create the desired function.*

## Entering User Functions (cont.)

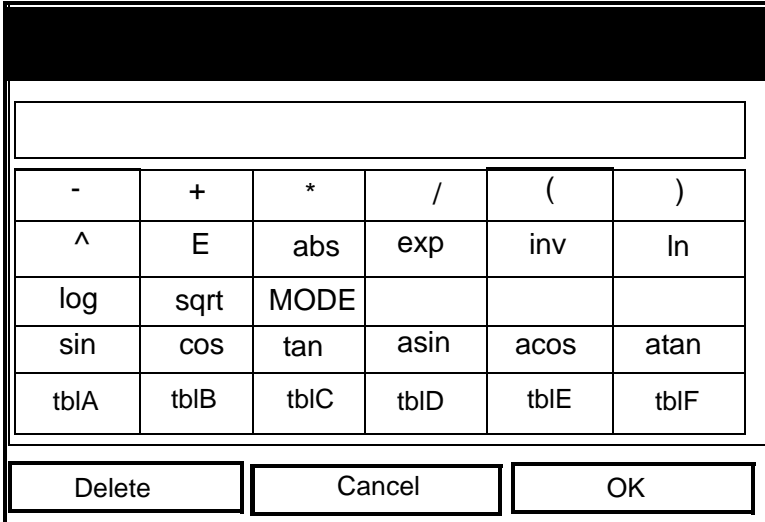

**Figure 4-23: The Function Creation Window**

- c. To enter a particular measured parameter into the equation, click on the MODE symbol in the middle of the third row. The Select Measurement window (shown in Figure 4-19 on page 4-40) opens. Select the desired data source and unit as discussed on page 4-40, and press [F3] (OK) to confirm the entry.
  - d. When you have completed entering the function, press [F3] (OK) to confirm the entry and return to the User Function window.
6. GE Infrastructure Sensing recommends pressing [F2] (Check) to test the validity of the function. The PT878GC displays either "OK" or a message such as "Syntax Error."
    - Press [F1] to delete the entire function and start again, or
    - Press [F2] to cancel the function and return to Operate Mode.
    - Press [F3] (Done) to confirm the function and return to Operate Mode.

## Entering Correction Factors

The final option in the Program Menu, Correction Factors, allows you to enter and modify three correction factors: Reynolds Correction, Kinematic Viscosity and Calibration Factor. To enter the Correction Factors option, scroll to the Correction Factors entry on the Program Menu and press [ENTER]. The screen appears similar to Figure 4-24 below. To step through each parameter, press the [▼] key. Refer to Figure A-7 on page A-7 of Appendix A, *Menu Maps*.

**Correction Factors**

Reynolds Correction   Calibration Factor

Re Correction    On    Off

K/V Factors    Single    Table

K/V x 10<sup>-6</sup>  m<sup>2</sup>/s

Data Source

Figure 4-24: Reynolds Correction Window

### Entering Reynolds Correction

1. The first prompt asks if you want to enable the Reynolds Correction factor, a number based on the Kinematic Viscosity and flow rate of the gas.
  - a. Use the [◀] and [▶] keys to scroll to the appropriate radio button.

## Entering Reynolds Correction (cont.)

- b. Press [ENTER] to confirm your selection.

**Note:** *If you disable Reynolds Correction, you will not be able to enter any other values in this window.*

2. If you enable Reynolds Correction, you will also need to enter the Kinematic Viscosity of the gas (available in the brochure *Sound Speeds and Pipe Size Data*, 914-004). The next prompt asks if you wish to enter the Kinematic Viscosity as a single number, or as a table of values.
  - a. Use the [◀] and [▶] keys to scroll to the appropriate radio button.
  - b. Press [ENTER] to confirm your selection.
3. The following steps depend on whether you select a single value or a table for Kinematic Viscosity.

*If you entered Single:*

The prompt asks for a kinematic viscosity value.

- a. Press [ENTER] to open the text box.
- b. Use the numeric keys to enter the known value (from *Sound Speeds and Pipe Size Data*).
- c. Press [ENTER] to confirm your selection.

You have completed entering data for a single Kinematic Viscosity factor.

*If you entered Table:*

The menu asks, first for the data source, and then for the entry of values into the Reynolds Correction table. This procedure allows the PT878GC to estimate Kinematic Viscosity from other measurements, such as signal strength.

- a. Press [ENTER] to open the Data Source window. The Select Measurement window (Figure 4-19 on page 4-40) appears.



## Entering Reynolds Correction (cont.)

- b. Enter the desired measurement and units as described on page 4-40.
  - c. Press [F3] (OK) to confirm your selection.
4. The prompt then asks if you wish to edit the Reynolds Correction table.
- a. Press [ENTER] to open the table, which appears similar to Figure 4-25 below.

The screenshot shows a window titled "Edit Reynolds Table". At the top is a black title bar with the text "Edit Reynolds Table" in white. Below the title bar is a white rectangular input field containing the number "0". Underneath the input field is a table with 5 rows and 2 columns. The first row is a header row with the columns labeled "Data Source" and "Re". The following four rows are empty data rows, with the first column containing the numbers 1, 2, 3, and 4 respectively. Below the table are two buttons: "Cancel" on the left and "OK" on the right.

Figure 4-25: Window for Reynolds Correction Table

- b. Use the numeric keys to enter the first value for the data source, and press [ENTER] to confirm the entry.
- c. Press the [▶] key to move to the Reynolds value column. Use the numeric keys to enter the corresponding value, and press [ENTER] to confirm the entry.
- d. Repeat steps b and c for the remainder of the table.

## Entering Reynolds Correction (cont.)

- e. When you have completed entering values, press [F3] (OK) to confirm the table and return to the Correction Factors window.

You have completed entering data for a Reynolds Correction table.

- To confirm the entries, press [F3] (OK). The meter returns to Operate Mode.
- To leave the window without confirming the entries and return to Operate mode, press [F2] (Cancel) or the [ESC] key.

## Entering a Calibration Factor

The Calibration Factor is used as a reference for the flowmeter electronics to ensure accurate readings. To enter a Calibration Factor, return to the Reynolds Correction tab at the top of the Correction Factors option. Press the [▶] arrow key to reach the Calibration Factor window. The window appears similar to Figure 4-26 below. To step through each parameter, press the [▼] key.

The screenshot shows a window titled "Correction Factors" with two tabs: "Reynolds Correction" and "Calibration Factor". The "Calibration Factor" tab is selected. The window contains the following elements:

- Calibration Factor:** A radio button is selected for "On", and "Off" is unselected.
- K Factor:** A radio button is selected for "Single", and "Table" is unselected.
- Meter K-Factor:** A text input field containing the value "1.0000".
- Data Source:** An empty text input field.
- Edit Table:** A button located below the Data Source field.
- Navigation:** At the bottom of the window, there are two buttons: "Cancel" and "OK".

Figure 4-26: The Calibration Factor Window

## Entering a Calibration Factor (cont.)

1. The first prompt asks if you wish to enable the calibration factor.
  - a. Use the [◀] and [▶] keys to scroll to the appropriate radio button.
  - b. Press [ENTER] to confirm your selection.
2. The next prompt asks if you want a single K factor or a table of K factors.
  - a. Use the [◀] and [▶] keys to scroll to the appropriate radio button.
  - b. Press [ENTER] to confirm your selection.
3. The following steps depend on whether you select a single value or a table.

*If you entered Single:*

The prompt asks for a value.

- a. Press [ENTER] to open the text box.
- b. Use the numeric keys to enter the recommended value. Generally, if you have enabled the Reynolds Correction factor, the correction factor should be set to 1.00. Otherwise, the typical factor is between 0.5 and 2.00.
- c. Press [ENTER] to confirm your selection.

You have completed entering data for a single Calibration Factor.

*If you entered Table:*

The menu asks, first for the data source, and then for the entry of values into the Correction Factor table.

- a. Press [ENTER] to open the Data Source window. The Select Measurement window (Figure 4-19 on page 4-40) appears.

## Entering a Calibration Factor (cont.)

- b. Enter the desired measurement and units as described on page 4-40.
  - c. Press [F3] (OK) to confirm your selection.
4. The prompt then asks if you wish to edit the K factor table.
- a. Press [ENTER] to open the table, which appears similar to Figure 4-27 below.

Edit KFactor Table		
		0
	Data Source	KFactor
1		
2		
3		
4		
5		

Figure 4-27: The KFactor Table

- b. Use the numeric keys to enter the first value for the data source, and press [ENTER] to confirm the entry.
- c. Press the [▶] key to move to the KFactor column. Use the numeric keys to enter the corresponding value, and press [ENTER] to confirm the entry.
- d. Repeat steps b and c for the remainder of the table.
- e. When you have completed entering values, press [F3] (OK) to confirm the table and return to the Correction Factors window.

## Entering a Calibration Factor (cont.)

You have completed entering data for correction factors.

- To confirm the entries and return to Operate Mode, press [F3] (OK).
- To leave the window without confirming the entries and return to Operate mode, press [F2] (Cancel) or the [ESC] key.

In either case, the meter returns to Operate Mode.

# Chapter 5

## Creating and Managing Sites

The PT878GC can store site data in files for current and future access. (To learn how to program setup data, refer to Chapter 4, *Programming Site Data*.) After you answer the necessary questions, simply save the information to a site file. The Site Manager option then enables you to recall, rename, print, transfer or delete site files as needed.

To open the Site Menu, press the [MENU] key at the lower right of the PT878GC keypad. The Menu Bar replaces the Status Bar at the top of the screen. Then press [ENTER]. The screen now appears similar to Figure 5-1 below. While following the programming instructions, refer to Figure A-2 on page A-2 of Appendix A, *Menu Maps*.

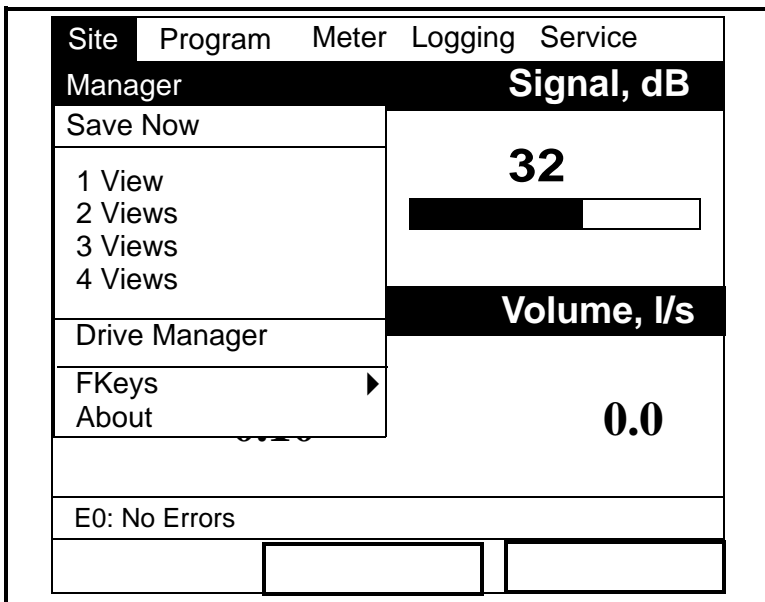

Figure 5-1: The Site Menu in the Main Menu

---

## The Site Manager

From the Site Menu, press [ENTER] to open the Site Manager. The screen appears similar to Figure 5-2 below.

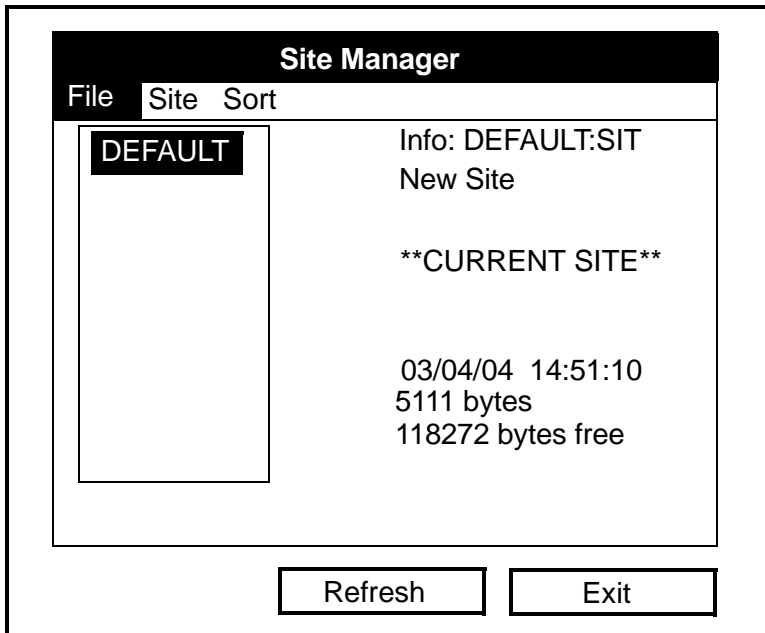

Figure 5-2: The Site Manager Window

**Note:** *Each PT878GC comes preprogrammed with a basic site, Default, which serves as a basis for saving data and creating other sites.*

The right section of the screen supplies information for the site highlighted in the list on the left: the date, time, and file size, as well as the amount of free memory remaining. You can use the [▼] and [▲] arrow keys to scroll to a particular site and display information pertaining to that site.

To open the File submenu within the Site Manager, press [MENU] and then [ENTER]. The screen now appears similar to Figure 5-3 on page 5-3.

## The Site Manager (cont.)

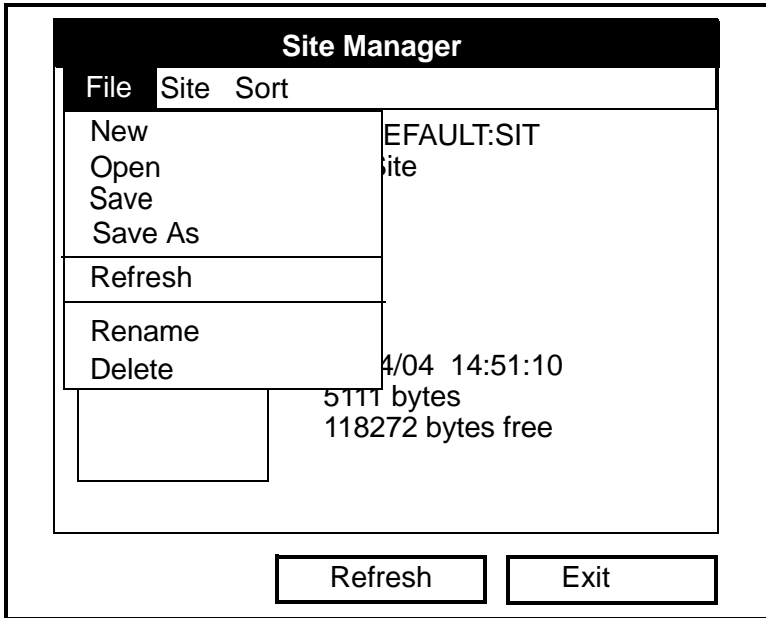

Figure 5-3: The Site Manager Menu

- To create a new site, go to page 5-4.
- To open an existing site (thus replacing the current site), go to page 5-6.
- To save a current site, go to page 5-7.
- To refresh site information, go to page 5-9.
- To rename a site, go to page 5-9.
- To delete a site, go to page 5-10.

You can access four additional functions from the Site submenu (shown in Figure 5-11 on page 5-11).

- To add a site message, go to page 5-11.
- To print out a site, go to page 5-13.
- To transfer a site to a PC, go to page 5-13.
- To transfer a site from a PC to the PT878GC, go to page 5-14.



## Creating a New Site

To create a new site in the Site Manager, press [MENU] in the Site Manager. Be sure the option New is highlighted, and then press [ENTER]. The screen appears similar to Figure 5-4 below.

New Site							
A	B	C	D	E	F	G	H
I	J	K	L	M	N	O	P
Q	R	S	T	U	V	W	X
Y	Z	0	1	2	3	4	5
6	7	8	9				
Delete		Cancel			OK		

**Figure 5-4: Name Entry Window for a New Site**

1. Use the four arrow keys to scroll to the desired letter or number, and press [ENTER].
2. Repeat this procedure until you have created the desired site name of up to eight characters. (Press [F1], Delete, to remove any unwanted letters or numbers.)
3. When you have finished, press [F3], OK, to confirm the entry.

A second screen appears (as shown in Figure 5-5 on the next page) asking if you want to use the currently highlighted site as a template for the new site, using its current display windows, measurements and programmed data. (To modify the display and measurements, refer to Chapter 6, *Displaying and Configuring Data*. To alter programming data, see Chapter 4, *Programming Site Data*.)

- Press [F2] (No) if you do not want to use it, or
- Press [F3] (Yes) if you want to use it as a template.

## Creating a New Site (cont.)

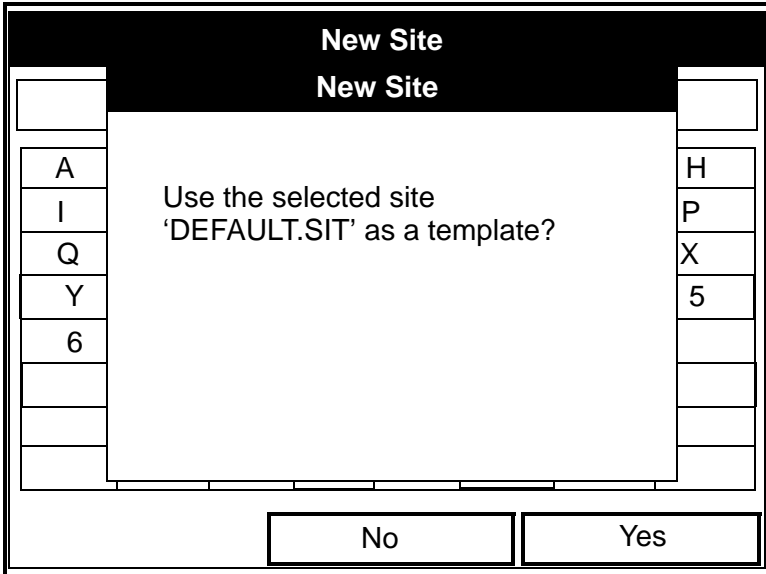
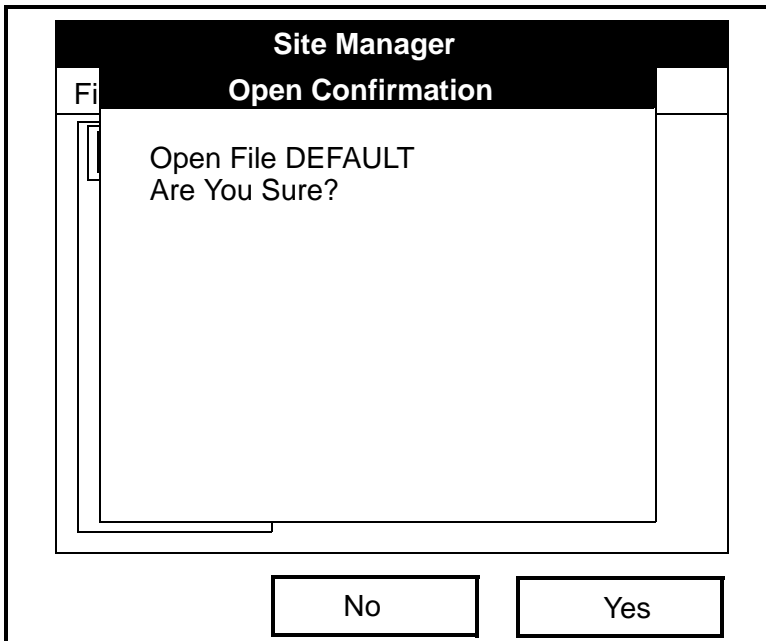

**Figure 5-5: Template Confirmation Window**

The meter returns to Operate Mode, with the new site name displayed in the upper left corner of the screen.

## Opening an Existing Site

If you want to return to a second site that you have previously saved, first highlight the replacement site in the left window of the Site Manager. Then press [MENU] to open the File Menu. Scroll to the Open option, and press [ENTER]. The screen appears similar to Figure 5-6 below.



**Figure 5-6: The Open Site Confirmation Window**

- Press [F2] (No) to cancel opening the site and return to the current site, or
- Press [F3] (Yes) to open the site.

If you have changed the first site (that is, the one you are now closing by opening the second site), the PT878GC asks if you want to save the changes to the first site.

- Press [F2] (No) to cancel the changes, or
- Press [F3] (Yes) to confirm and save the changes.

The PT878GC returns to Operate Mode, with the selected site displayed in the upper left corner of the screen.

## Saving a Site

You can save the current site in one of two ways:

- From the Site Menu, you can scroll down to the Save Now option and press [ENTER], or
- From within the Site Manager, press [MENU], scroll to the Save option, and press [ENTER].

In either case, the screen appears similar to Figure 5-7 below.

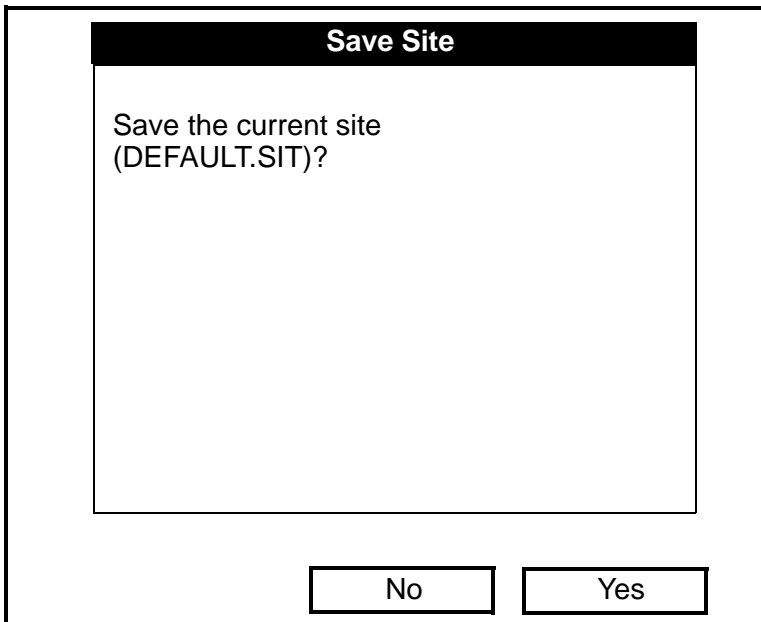

**Figure 5-7: The Save Current Site Window**

- Press [F2] (No) to cancel saving the site, or
- Press [F3] (Yes) to save the site.

The PT878GC remains in the current window (Operate Mode or Site Manager), with the current site saved.

## Saving a Site with a Different Name

If you want to save the current site with a different name, open the Site Manager, press [MENU] to open the File Menu, scroll to the Save As option, and press [ENTER]. The screen appears similar to Figure 5-8 below.

Save Current Site							
A	B	C	D	E	F	G	H
I	J	K	L	M	N	O	P
Q	R	S	T	U	V	W	X
Y	Z	0	1	2	3	4	5
6	7	8	9				
Delete		Cancel			OK		

**Figure 5-8: The Save As (Another Name) Window**

1. Use the four arrow keys to scroll to the desired letter or number, and press [ENTER].
2. Repeat this procedure until you have created the desired site name with up to eight characters. (Press [F1], Delete, to remove any unwanted letters or numbers.)
3. When you have finished,
  - Press [F2] (Cancel) to erase the entry, or
  - Press [F3], OK, to confirm the entry.

The Save Site window then appears.

- Press [F2] (No) to cancel saving the site, or
- Press [F3] (Yes) to save the site.

The PT878GC remains in Site Manager, with the current site saved under both the old and new names.

## Refreshing a Site

You can refresh a site (updating the display with the most current information) in one of two ways:

- Press [F2], Refresh, to refresh the highlighted file.
- From the File Menu, scroll to the Refresh option and press [ENTER].

The updated information on the highlighted file appears in the window on the right.

## Renaming a Site

If you want to rename a site, first be sure the site has been highlighted in the left window of the Site Manager. Then press [MENU] to enter the File Menu, scroll to the Rename option, and press [ENTER]. The screen appears similar to Figure 5-9 below.

Rename Site							
DEFAULT							
A	B	C	D	E	F	G	H
I	J	K	L	M	N	O	P
Q	R	S	T	U	V	W	X
Y	Z	0	1	2	3	4	5
6	7	8	9				
Delete		Cancel			OK		

**Figure 5-9: The Rename Site Window**

Use the four arrow keys to scroll to the desired letter or number, and press [ENTER]. Repeat this procedure until you have created the desired site name. (Press [F1], Delete, to remove any unwanted letters or numbers.) When you have finished,

- Press [F2] (Cancel) to erase the entry, or
- Press [F3], OK, to confirm the entry.

The PT878GC remains in Site Manager, with the site listed under the new name (but not the old name).

## Deleting a Site

To delete a site in the Site Manager, first be sure you have highlighted that site in the left window of the Site Manager. Then press [MENU], scroll to the Delete option, and press [ENTER]. The screen appears similar to Figure 5-10 below.

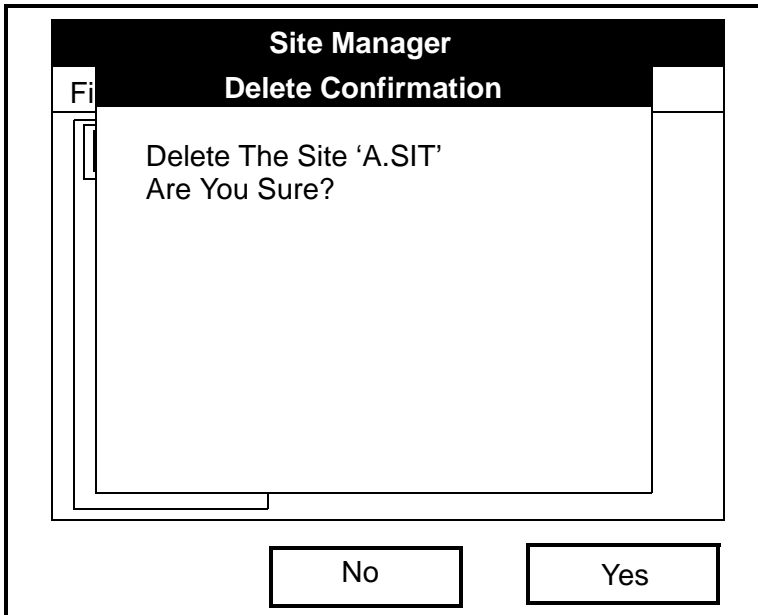

**Figure 5-10: The Delete Confirmation Window**

- Press [F2], No, to cancel the deletion and return to the Site Manager, or
- Press [F3], Yes, to delete the site.

The Site Manager appears, with the highlighted site now deleted.

## Creating a Site Message

The Site Message option allows you to add an explanatory message (with up to 30 characters or spaces) for any given site. To create a site message:

1. Press [MENU] to enter the File Menu. Then press the [▶] arrow key once to scroll from the File Menu to the Site Menu. Press [ENTER]. The screen appears similar to Figure 5-11 below.

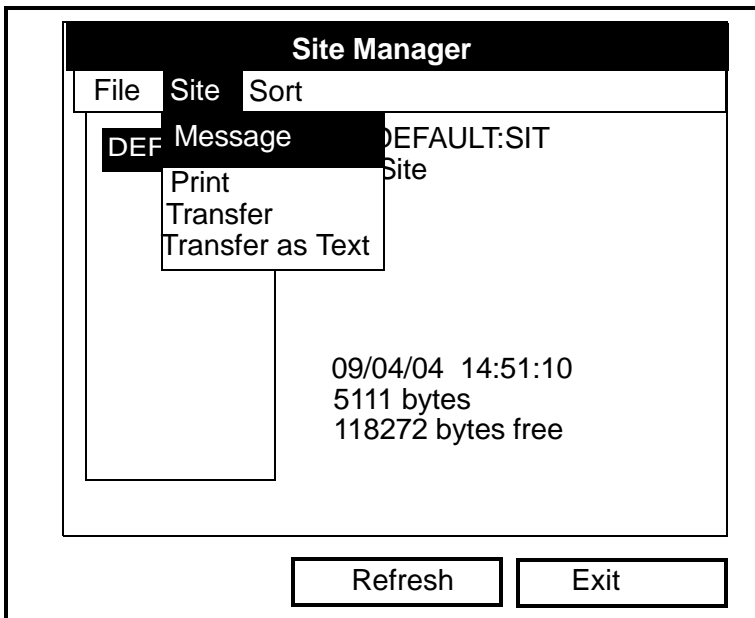
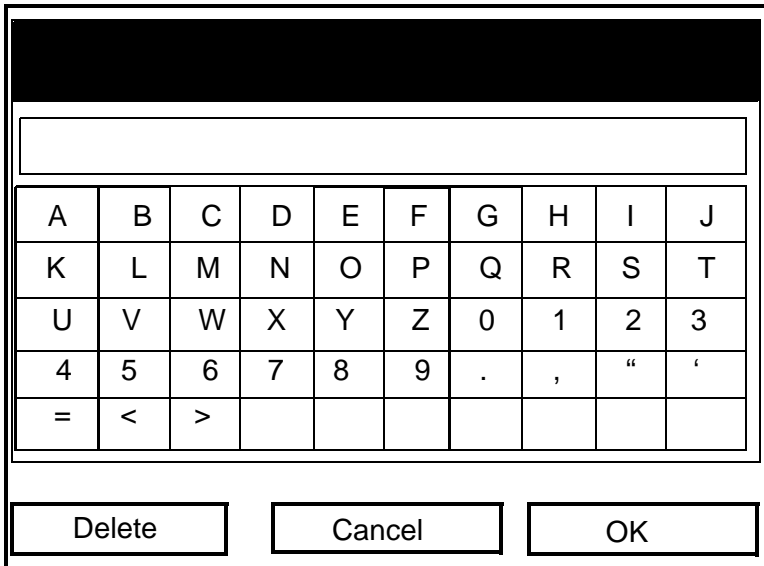

**Figure 5-11: The Site Menu in the Site Manager**

2. Press [ENTER] to select "Message," which opens the text creation window, shown in Figure 5-12 on the next page.



## Creating a Site Message (cont.)



**Figure 5-12: The Text Creation Window**

3. Use the four arrow keys to scroll to the desired letter or symbol, and press [ENTER] to add the letter to the message.

**Note:** *Pressing [SEL] causes the screen to alternate between a set of upper-case (capital) letters, a set of lower-case letters, and a set of symbols. Use all three screens to create a desired message.*

4. Repeat this procedure for each letter or symbol you wish to add to the message. If you wish to delete a letter, press [F1] (Delete) to erase each letter or symbol, from right to left on the label.
5. When you have completed the message, press [F3] (OK) to confirm the message, or [F2] (Cancel) to leave the window without adding the message.

## Printing a File

To print a file from the Site Manager, press [MENU] to enter the File Menu, press the [▶] arrow key once, scroll to the Print option, and press [ENTER]. The PT878GC shows a message indicating that its infrared scanner is looking for a receiving device. (If the scanner finds no device, a window appears indicating that the meter can find no device. If it finds more than one compatible infrared device within range, it asks you to select the desired device.) If successful, the PT878GC returns to Operate Mode, while the thermal printer prints out the current site.

## Transferring a Site File to a PC

To upload a site file to a PC, you must have an infrared sensor connected to the PC (or incorporated into the PC) that can receive data from the PT878GC IR beam.

1. Check that the Communications option (see page 7-15) has been set to the IrDA protocol.

**Note:** *For Windows NT 4.0, check that the QuickBeam software (available through the path C:\Program Files\QuickBeam Suite) is running, and that the IR beam on the PT878GC has clear access to the IR sensor connected to the PC port.*

2. Highlight the desired site in the left window of the Site Manager.
3. Press [MENU] to open the File Menu, press the [▶] arrow key once, scroll to the Transfer option, and press [ENTER].

The screen shows a message indicating that the PT878GC is searching for an infrared device. (If the scanner finds no device, a window appears with this message, and asks if you want to try again.) If it finds a device, it sends another message indicating that it is uploading the site. (The meter also displays a message if the upload fails.) When the upload is complete, the meter returns to the Site Manager. The PC holds the transferred file in the QuickBeam (or IR) Inbox folder, as shown in Figure 5-13 on page 5-14. You can open the file on the PC using any text editor.

## Transferring a Site to a PC (cont.)



Figure 5-13: The IR\_Inbox Folder with Transferred Site File

### Transferring a File as Text

If you want to review site programming data as text, the PT878GC can transfer a site file to a PC in a Unicode text format that can be opened by text editors such as Notepad or Word. Again, you must have an infrared sensor connected to the PC (or incorporated into the PC) that can receive data from the PT878GC IR beam.

1. Check that the Communications option (see page 7-15) has been set to the IrDA protocol.

**Note:** *For Windows NT 4.0, check that the QuickBeam software (available through the path C:\Program Files\QuickBeam Suite) is running, and that the IR beam on the PT878GC has clear access to the IR sensor connected to the PC port.*

2. Highlight the desired site in the left window of the Site Manager.
3. Press [MENU] to open the File Menu, press the [▶] arrow key once, scroll to the Transfer as Text option, and press [ENTER].

The PT878GC transfers the file as discussed on the previous page; however, the file has a .txt extension, and it cannot be sent back to the PT878GC in this format.

## Transferring a File from a PC to the PT878GC

Once you have stored site or meter files to a PC, you can then transfer them back to the PT878GC over the IR interface. The PT878GC only accepts files with a .sit (site) or .met (meter) extension. If you rename another type of file with one of these extensions and transfer it, it will be transferred, but will not function if you open it. Also, if you are transferring a file and the meter already has a file with the identical name, the meter will overwrite its current file with the transferred file. If the transferred file has a name longer than eight characters, the meter will shorten the name to eight characters, and replace any spaces in the name with underbars.

To download a site or meter file from a PC to a PT878GC:

1. Check that the Communications option (see page 7-15) has been set to the IrDA protocol.

**Note:** *For Windows NT 4.0, check that the QuickBeam software (available through the path C:\Program Files\QuickBeam Suite) is running, and that the IR beam on the PT878GC has clear access to the IR sensor connected to the PC port.*

2. You can send the file in one of two ways:
  - Click on the desired file, and drag it onto the rocket button in the QuickBeam window, as shown in Figure 5-14 below.

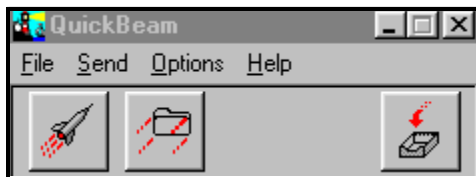

Figure 5-14: The QuickBeam Window

- Open the Send menu in the QuickBeam window, enter the *Files* or *Files on Clipboard* option, scroll to the desired file, and click *Send*.

## Transferring a File from a PC to the PT878GC (cont.)

QuickBeam opens a window indicating that it is downloading the file. If you close and reopen the Site Manager, the file appears as one of the listed sites.

**Note:** *While sending or receiving files, the PT878GC continues to perform measurements, but at a slower rate than normal.*

## Listing Files by Name

If you want to list your files alphabetically by site name within the Site Manager, press [MENU] to open the File Menu. Then press the [▶] arrow key twice to scroll from the File Menu to the Sort Menu, shown in Figure 5-15 below. Press [ENTER]. The Site Manager screen refreshes, with the sites listed in alphabetical order.

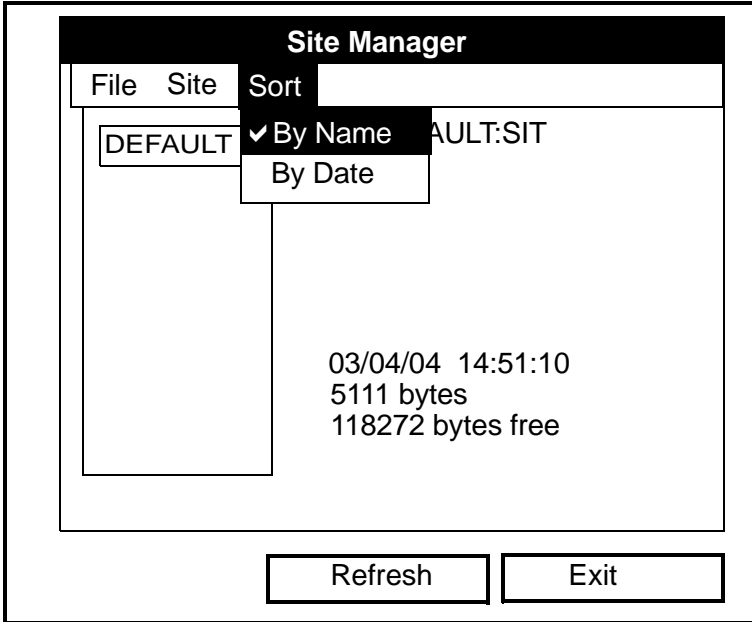

Figure 5-15: The Sort Submenu

## Listing Files in Chronological Order

If you prefer to list your files chronologically by time of creation within the Site Manager, press [MENU] to open the File Menu. Then press the [▶] arrow key twice to scroll from the File Menu to the Sort Menu, and scroll to the By Date option. Press [ENTER]. The Site Manager screen refreshes, with the sites listed in chronological order, from the most recent to the earliest.

# Chapter 6

## Displaying and Configuring Data

The PT878GC allows you to view from one to four different measurement parameters simultaneously. The screen can show these parameters not only in numeric format, but as line or bar graphs as well.

You can configure any given measurement for your particular requirements. To configure an individual measurement, press [SEL] from the Operate Mode window shown in Figure 2-5 on page 2-9. A cursor appears next to the parameter closest to the upper left corner. Continuing to press [SEL] enables the cursor to scroll through the other displayed measurements. Once you have reached a particular window, pressing the [ENTER] button opens the menu for that window, as shown in Figure 6-1 below. To learn how to use the display window menu, go to pages 6-2 to 6-6.

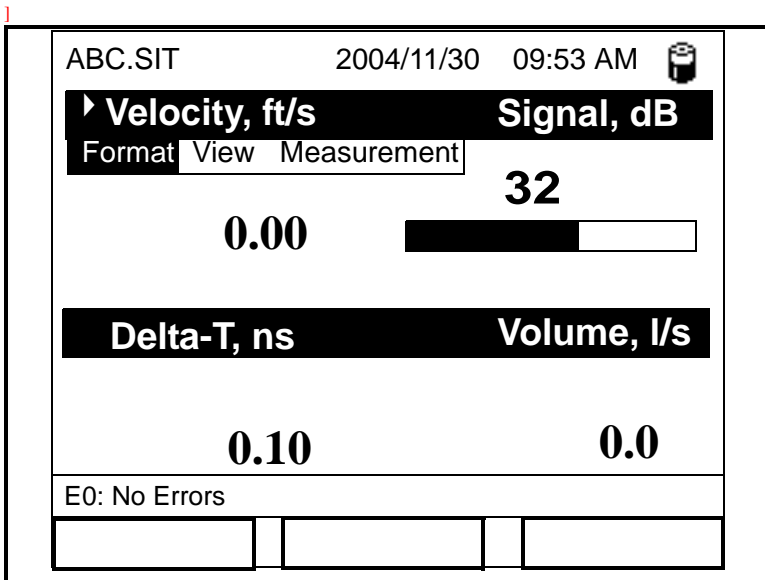

Figure 6-1: Display Screen After Pressing [SEL]

---

## The Format Option

The first option on the menu, Format, allows you to specify the type of notation and the number of decimal places for the measurement in that window. Press [ENTER] and the submenu shows two options, Decimal Place and Notation. Press the [▼] or [▲] arrow keys to select either entry, and press [ENTER]. The screen appears similar to Figure 6-2 below. To scroll to a particular parameter or menu entry, press the [▼] or [▲] key.

**Note:** *If the window displays a line or bar graph, the Limits option (see page 6-5) appears instead of Format in the menu.*

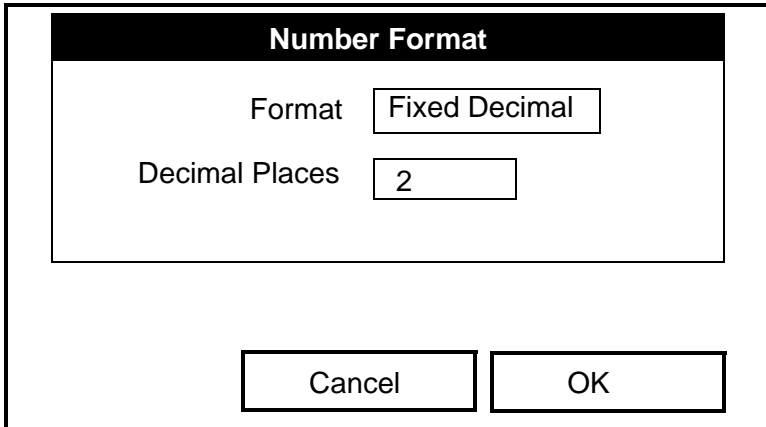

**Figure 6-2: The Number Format Window**

1. The first entry, Format, asks you to select the numeric format from three choices: fixed decimal, default and scientific. Default provides the default resolution, while Fixed Decimal allows users to override the standard resolution. Scientific format displays the value in mantissa and exponent format.
  - a. Press [ENTER] to open the drop-down list of format choices.
  - b. Scroll to the appropriate selection.
  - c. Press [ENTER] to confirm your choice.



---

## The Format Option (cont.)

2. The second step asks you to choose the number of decimal places to be displayed. Available choices range from 0 to 4 places.
  - a. Press [ENTER] to open the drop-down list.
  - b. Scroll to the appropriate number.
  - c. Press [ENTER] to confirm your choice.
- To confirm the entries and return to Operate mode, press [F3] (OK).
- To leave the window without confirming the entries, press [F2] (Cancel) or the [ESC] key.

## The View Option

The second option, View, allows you to select the presentation of a parameter in one of three formats: numeric, line graph or bar graph.

1. From the Display Menu, press the [▶] key once to reach the View option, and then press [ENTER].
2. A drop-down menu shows the three formats. Scroll to the appropriate selection.
3. Press [ENTER] to confirm your selection.

The screen immediately displays any changes. For example, if you have changed the first parameter to a line graph, the screen appears similar to Figure 6-3 below.

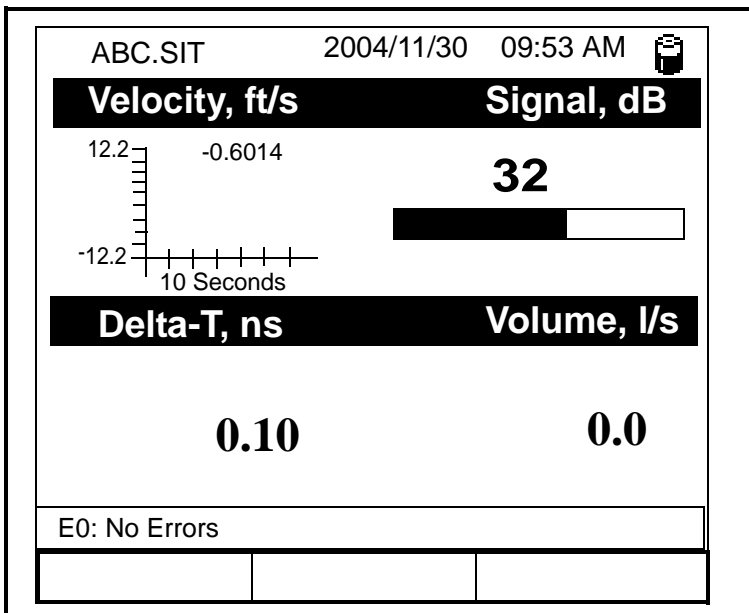

Figure 6-3: Screen After Format Change

## The Limits Option

Once you have configured a parameter as a line or bar graph, you might need to change its presentation or values. The Limits option (replacing the Format option for line and bar graphs) enables you to program the minimum or maximum values displayed, the time interval and the display of the average value.

To enter the Limits option:

1. Press [SEL] from the Operate Mode window until you have reached the desired measurement.
2. Press [ENTER] to open the Display Menu.
3. Be sure the Limits option is highlighted, and press [ENTER].

The screen appears similar to Figure 6-4 below.

**Set Line Graph Parameters**

Velocity

Minimum

Maximum

Use Lines

Plot Average Value

Show Minimum and Maximum

Figure 6-4: The Line (or Bar) Graph Parameters Window

## The Limits Option (cont.)

4. The first prompt asks for the minimum value shown in the graph.
  - a. Press [ENTER] to open the text box.
  - b. Use the numeric keys to enter the desired value.
  - c. Press [ENTER] to confirm the value.
5. Repeat the procedure in step 5 to enter the maximum value.

A line graph involves two more prompts.

6. The next prompt asks for the display interval.
  - a. Press [ENTER] to open the text box. Use the numeric keys to enter the desired number. Press [ENTER] to confirm the value.
  - b. The second box asks for the interval in terms of seconds, minutes, hours, or days. Press [ENTER] to open the drop-down menu, and then press the [▼] or [▲] keys to move to the desired parameter. Press [ENTER] to confirm the entry.
7. The final three prompts ask for details of the graph configuration: if you want to use lines, plot the average value, or show the minimum and maximum values. Press the [▼] key to step through each value, and press [ENTER] to add a given detail as part of the graph.
8. When you have configured the graph, press [F3], OK, to confirm the graph settings.

The screen returns to Operate Mode, and displays any changes.

---

## The Measurement Option

On occasion, you might need to change the actual parameter measured in a given window. The Measurement option enables you to reconfigure the window with one of five categories of data source (velocity, volume, forward or reverse totalizer, or diagnostics) and appropriate English or metric measurement units.

To enter the Measurement option:

1. Press [SEL] from the Operate Mode window until you have reached the desired measurement.
2. Press [ENTER] to open the Display Menu.
3. Be sure the Measurement option is highlighted, and press [ENTER].

The screen appears similar to Figure 6-5 on page 6-8. The left column displays the measurement data sources, while the right column displays English and metric measurement units (or, with the Diagnostics source shown, a list of diagnostics parameters).

4. Use the [▼] and [▲] arrow keys to reach the desired data source, and press [SEL].
5. Then use the [▼] or [▲] arrow keys to select the desired measurement unit (or diagnostic parameter). To speed scrolling, you can press the [▶] key to scroll down by a page, or the [◀] key to scroll up by a page. Press [F3], OK, to confirm the entry.
6. The screen returns to Operate Mode, and displays any changes.

## The Measurement Option (cont.)

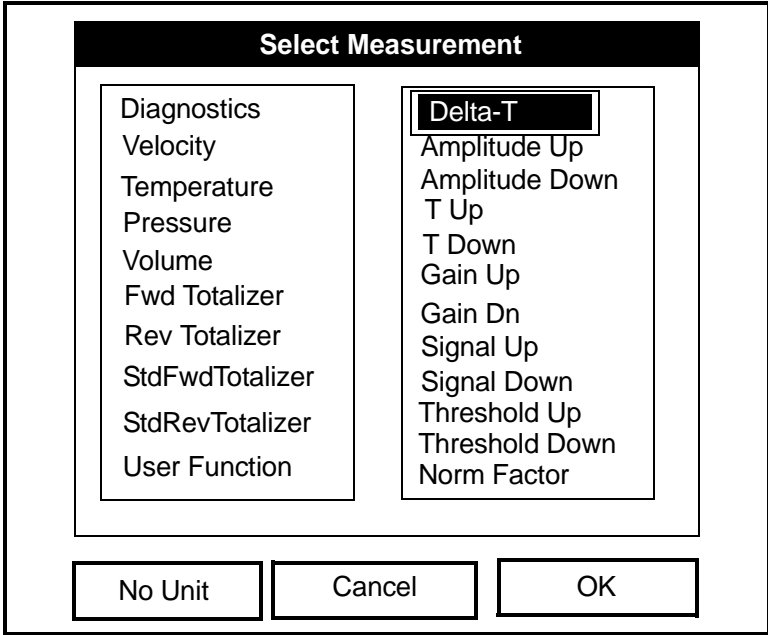

Figure 6-5: The Measurement Menu Window

## Customizing the Display Screen

You might wish to display one or two parameters, or customize the soft keys to quickly access particular menus. The Site Menu enables you to make more comprehensive changes in your display screen.

To enter the Site Menu, press the [MENU] key at the lower right of the PT878GC keypad. The Menu Bar replaces the Status Bar at the top of the screen. The Site Menu will be highlighted in the upper left corner. Press [ENTER] or the [▼] arrow key. The screen now appears similar to Figure 6-6 below. While following the programming instructions, refer to Figure A-2 on page A-2 of Appendix A, *Menu Maps*.

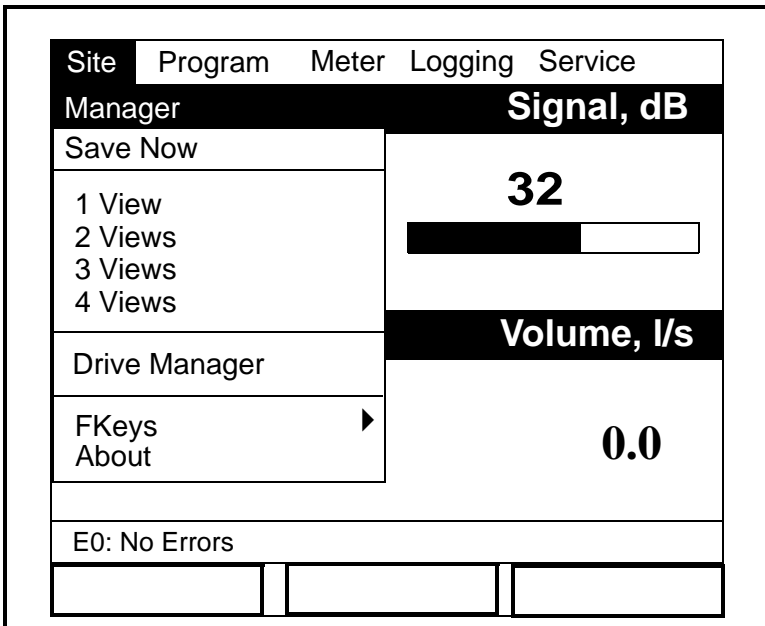

Figure 6-6: The Site Menu

- To specify the number of parameters displayed, go to page 6-10.
- To customize or clear softkeys (FKeys), go to page 6-11.

## Specifying the Number of Displayed Parameters

As mentioned earlier, the PT878GC can display one to four different measurement parameters simultaneously. However, sometimes you might wish to display only one or two parameters. To change the number of open display windows:

1. Press [MENU].
2. From the Site Menu (shown in Figure 6-6 on page 6-8), use the [▼] or [▲] arrow keys to move to the desired number of views (1 View, 2 Views, etc.) Press [ENTER].

The screen displays the designated number of windows. For example, Figure 6-7 below shows the screen displayed in Figure 6-3 on page 6-4, reconfigured for a single view.

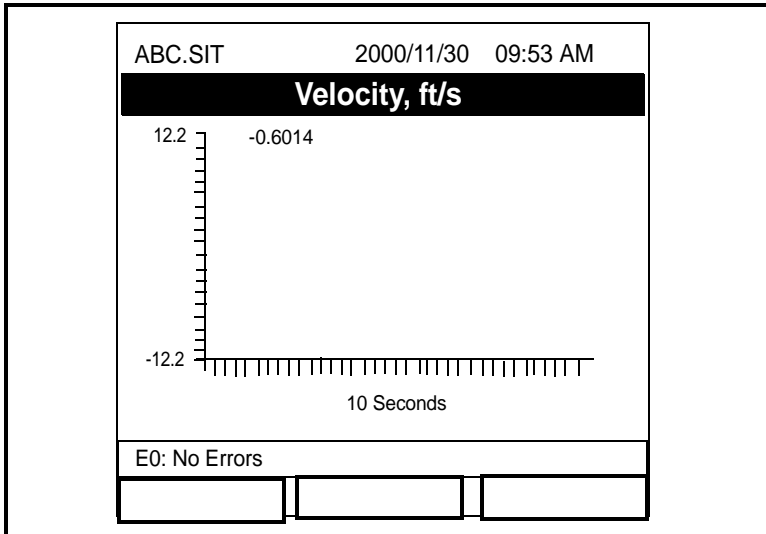

**Figure 6-7: Display Screen Configured for Single View**

**Note:** *The PT878GC opens display windows from the top; that is, if you press “1 View,” one parameter appears. If you press “2 Views,” two parameters appear, one on the top and one on the bottom. The view for “3 Views” adds a window in the lower right, and that for “4 Views” sends the second parameter to the upper right corner, with the third parameter in the lower left and the fourth parameter in the lower right.*



## Customizing Softkeys

When the screen is in Operate mode, you might wish to access a particular submenu frequently without the trouble of scrolling through menus. Customizing the softkeys (the function keys — [F1], [F2] and [F3]) allows you to access up to three submenus by pressing the associated softkey. You can customize a softkey from the Site Menu or from within a particular menu.

- To customize a softkey from the Site Menu:
  1. Press [MENU].
  2. From the Site Menu (shown in Figure 6-6 on page 6-9), use the [▼] or [▲] arrow keys to move to the FKeys entry on the menu. Press [ENTER]. The screen now appears similar to Figure 6-8 below.

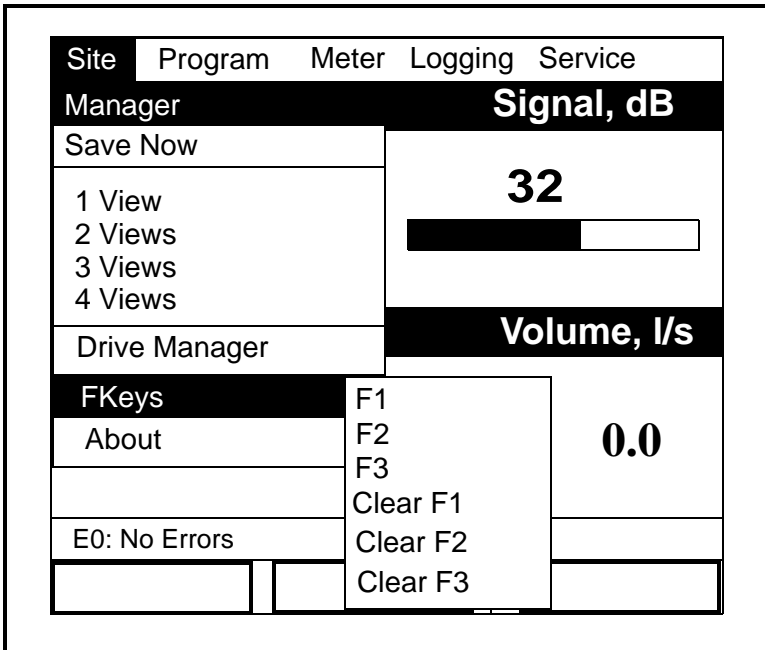

Figure 6-8: The FKeys Menu

3. Use the [▼] or [▲] arrow keys to move to the desired FKey (1, 2 or 3) entry on the menu. Press [ENTER]. The Configure FKey window opens, as shown in Figure 6-9 on the next page.

## Customizing Softkeys (cont.)

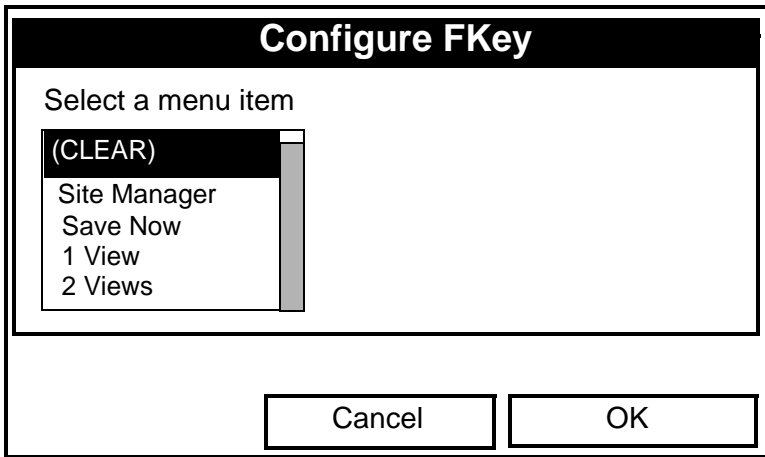

Figure 6-9: The Configure FKey Window

4. Press [ENTER] to open the menu drop-down list. Then use the [▼] or [▲] arrow keys to scroll to the desired submenu (for example, Contrast).
5. Press [ENTER] to confirm the entry, and press [F3] (OK) to confirm the entry and close the window. (Press [F2] (Cancel) to close the window without changing the key.)

The screen now appears similar to Figure 6-10 on the next page, with the [F1] window displaying “Contrast.” Pressing [F1] opens the Contrast window.

- To customize a softkey from a particular menu:
  1. Open the desired menu on the Menu Bar (see Chapters 4, 5, 7, 8, and 9 for details on particular menus) and scroll to the desired option.
  2. Press the desired softkey. A window appears with the question, “Assign current menu command to FKeyX?”
  3. Press [F3] (Yes) to confirm the assignment and close the window. (Press [F2] (No) to close the window without changing the key.)

## Customizing Softkeys (cont.)

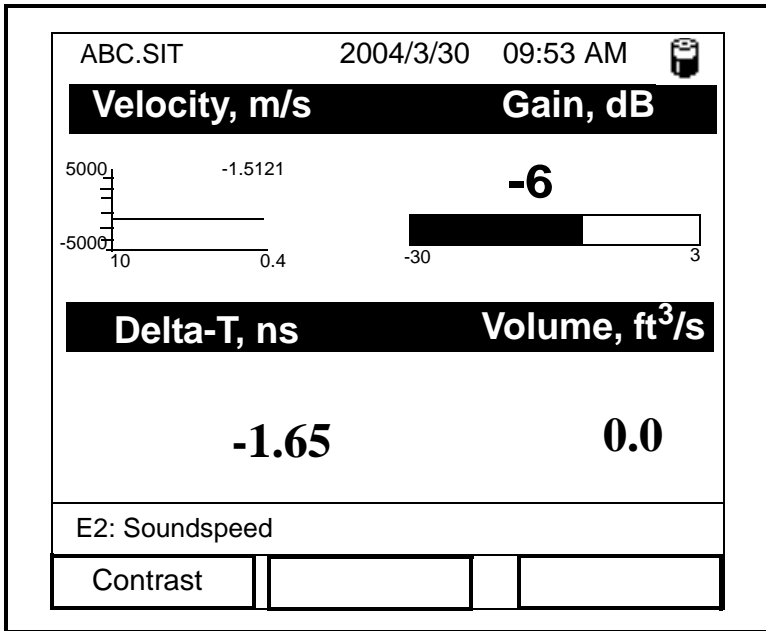

Figure 6-10: The Display Screen with Modified Softkey

- To clear a softkey:
  1. Press [MENU].
  2. From the Site Menu (shown in Figure 6-6 on page 6-8), use the [▼] or [▲] arrow keys to move to the FKeys entry on the menu. Press [ENTER]. The screen now appears similar to Figure 6-8 on page 6-11.
  3. Use the [▼] or [▲] arrow keys to move to the desired Clear FKey (1, 2 or 3) entry on the menu. Press [ENTER].

The softkey window clears. You can also clear the softkey through the Configure FKey window, by selecting (Clear) as an entry, pressing [ENTER] and then [F3], OK.

**Note:** *Since the customized softkeys are saved globally, they will remain, even if you change site files.*

---

## Managing Files — The Drive Manager

On occasion, you might want to review, print or transfer some or all of the files in the PT878GC. The Drive Manager allows you to view all the files stored in the meter. To open the Drive Manager:

1. Press [MENU].
2. From the Site Menu (shown in Figure 6-6 on page 6-8), use the [▼] or [▲] arrow keys to move to the Drive Manager entry on the menu. Press [ENTER]. The screen now appears similar to Figure 6-11 below.

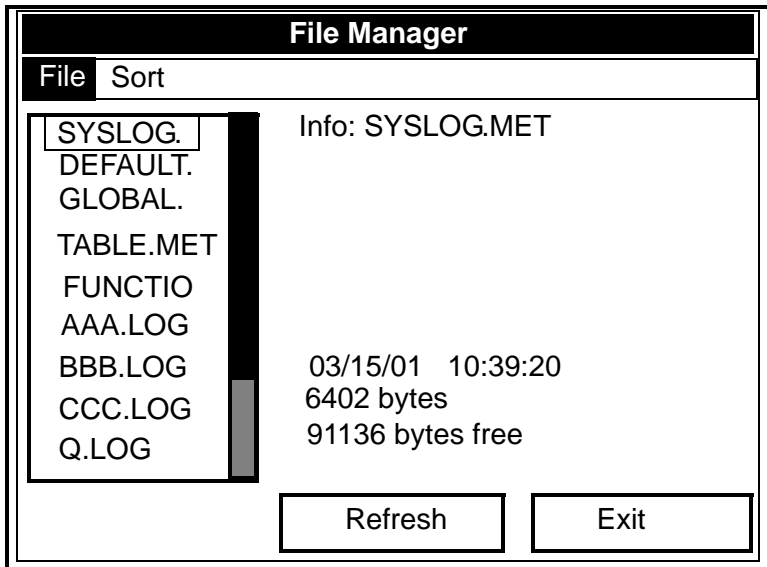

Figure 6-11: The Drive Manager Window

The window on the left lists all the meter, site and log files in the PT878GC, while the window on the right displays information on the file highlighted in the left window.

## Managing Files — The Drive Manager (cont.)

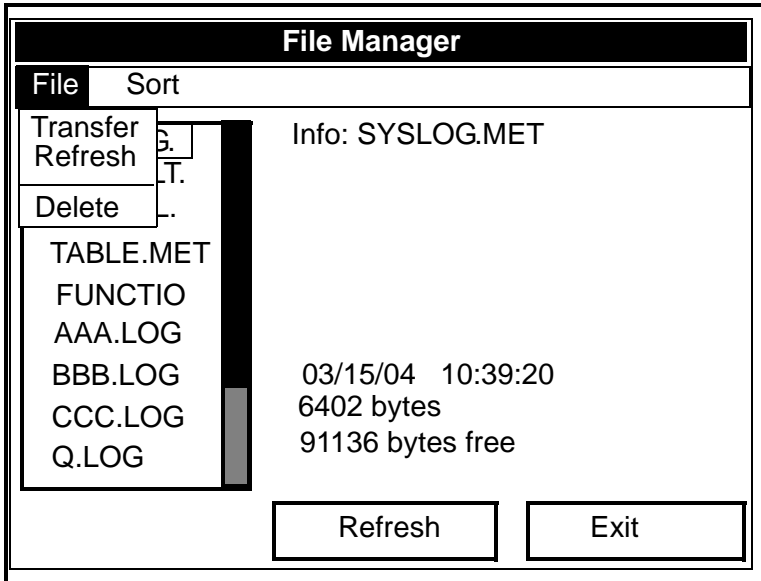

Figure 6-12: The File Manager Menu

To transfer, refresh or delete a file, first be sure the file is highlighted in the window on the left. Then press [MENU] and scroll to the appropriate option, as shown in Figure 6-12 above. Press [ENTER]. The PT878GC then performs the desired action with the file.

- To refresh a file, go to the next page.
- To transfer a file to or from a PC, go to the next page.
- To delete a file, go to page 6-19.

## Refreshing a File

You can refresh a file (updating the display with the most current information) in one of two ways:

- Press [F2], Refresh, to refresh the highlighted file.
- From the File Menu, scroll to the Refresh option and press [ENTER].

The updated information on the highlighted file appears in the window on the right.

## Transferring a File to a PC

To upload a log, meter, screen capture (bitmap) or site file to a PC:

1. Check that the Communications option (see page 7-15) has been set to the IrDA protocol.

**Note:** *For Windows NT 4.0, check that the QuickBeam software (available through the path C:\Program Files\QuickBeam Suite) is running, and that the IR beam on the PT878GC-GC has clear access to the IR sensor connected to the PC port.*

2. Highlight the desired site in the left window of the Drive Manager.
3. Press [MENU], scroll to the Transfer option, and press [ENTER].

The screen shows a message indicating that the PT878GC is searching for an infrared device. (If the scanner finds no device, a window appears with this message, and asks if you want to try again.) If it finds a device, it sends another message indicating that it is uploading the site. (The meter also displays a message if the upload fails.) When the upload is complete, the meter returns to the Drive Manager. The PC holds the transferred file in the QuickBeam (IR) Inbox folder, as shown in Figure 6-13 on the next page. You can open the file on the PC using any text editor.

## Transferring a File to a PC (cont.)

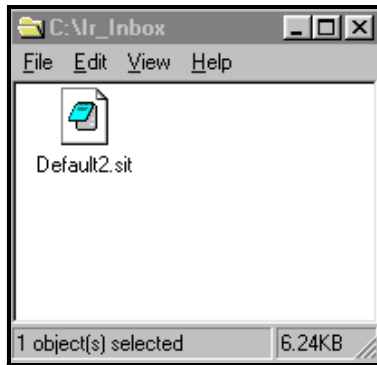

Figure 6-13: The IR\_Inbox Folder with Transferred File

## Transferring a File from a PC to the PT878GC

Once you have stored site or meter files to a PC, you can then transfer them back to the PT878GC over the IR interface. The PT878GC only accepts files with a .sit (site) or .met (meter) extension. If you try renaming another type of file with a .sit or .met extension and transfer it, it will be transferred, but it will not function if you open it. Also, if you are transferring a file and the meter already has a file with the identical name, the meter will overwrite its current file with the transferred file. If the transferred file has a name longer than eight characters, the meter will shorten the name to eight characters, and replace any spaces in the name with underbars.

**Note:** *It is not possible to download log files back to the PT878GC.*

To download a site or meter file from a PC to a PT878GC:

1. Check that the Communications option (see page 7-15) has been set to the IrDA protocol.

## Transferring a File from a PC to the PT878GC (cont.)

**Note:** *For Windows NT 4.0, check that the QuickBeam software (available through the path C:\Program Files\QuickBeam Suite) is running, and that the IR beam on the PT878GC has clear access to the IR sensor connected to the PC port.*

2. You can send the file in one of two ways:

- Click on the desired file, and drag it onto the rocket button in the QuickBeam window, as shown in Figure 6-14 below.

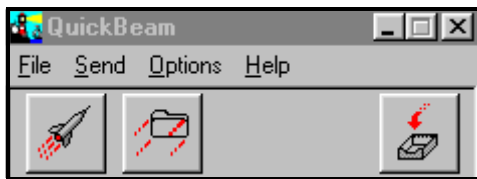

Figure 6-14: The QuickBeam Window

- Open the Send menu in the QuickBeam window, enter the *Files* or *Files on Clipboard* option, scroll to the desired file, and click *Send*.

QuickBeam opens a window indicating that it is downloading the file. When the download is complete, the meter returns to the Drive Manager. If you close and reopen the Drive Manager, the file appears as one of the listed sites.

**Note:** *While sending or receiving files, the PT878GC continues to perform measurements, but at a slower rate than normal.*



## Deleting a File

To delete a file in the File Manager, first be sure you have highlighted that site in the left window of the File Manager. Then press [MENU], scroll to the Delete option, and press [ENTER]. The screen appears similar to Figure 6-15 below.

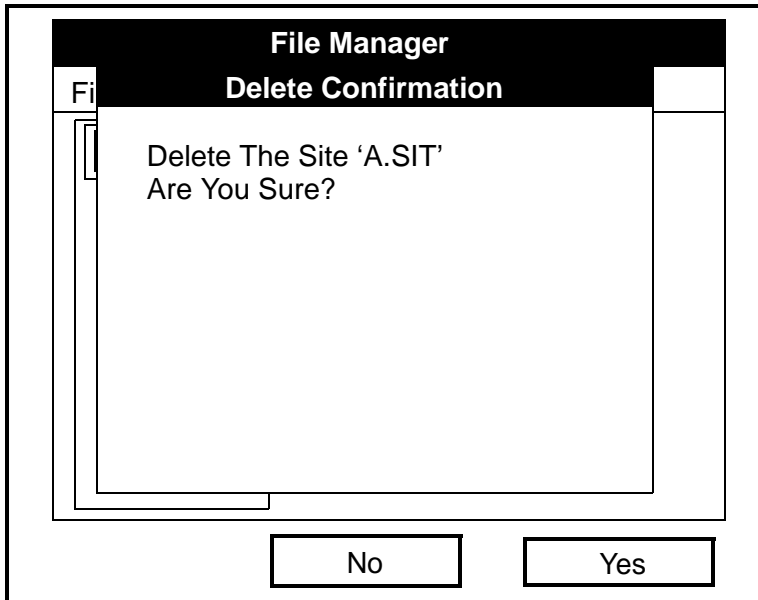

**Figure 6-15: The Delete Confirmation Window**

- Press [F2], No, to cancel the deletion and return to the File Manager, or
- Press [F3], Yes, to delete the site.

The File Manager appears, with the highlighted site now deleted.

## Listing Files by Name

If you want to list your files alphabetically by site name within the File Manager, press [MENU] to open the File Menu. Then press the [▶] arrow key to scroll from the File Menu to the Sort Menu, shown in Figure 6-16 below. Press [ENTER]. The File Manager screen refreshes, with the sites listed in alphabetical order.

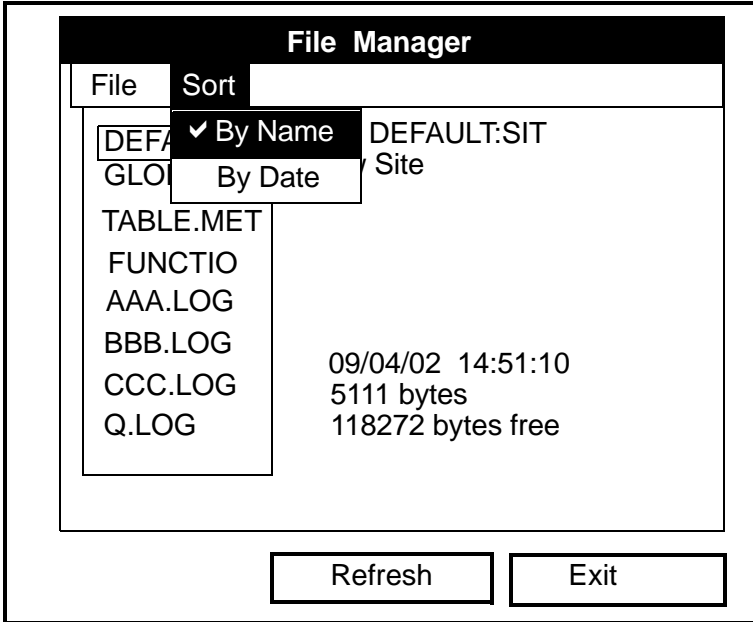

Figure 6-16: The Sort Submenu

## Listing Files in Chronological Order

If you prefer to list your files chronologically by time of creation within the File Manager, press [MENU] to open the File Menu. Then press the [▶] arrow key to scroll from the File Menu to the Sort Menu, and scroll to the By Date option. Press [ENTER]. The Site Manager screen refreshes, with the sites listed in chronological order, from the most recent to the earliest.

---

## Accessing Meter Data —The About Option

The About option displays useful information concerning the model number and software version of your PT878GC. While the window normally appears briefly at startup, users might want to access the information for a longer period. To open the About window, scroll to the About option on the Site Menu and press [ENTER]. The screen appears similar to Figure 6-17 below.

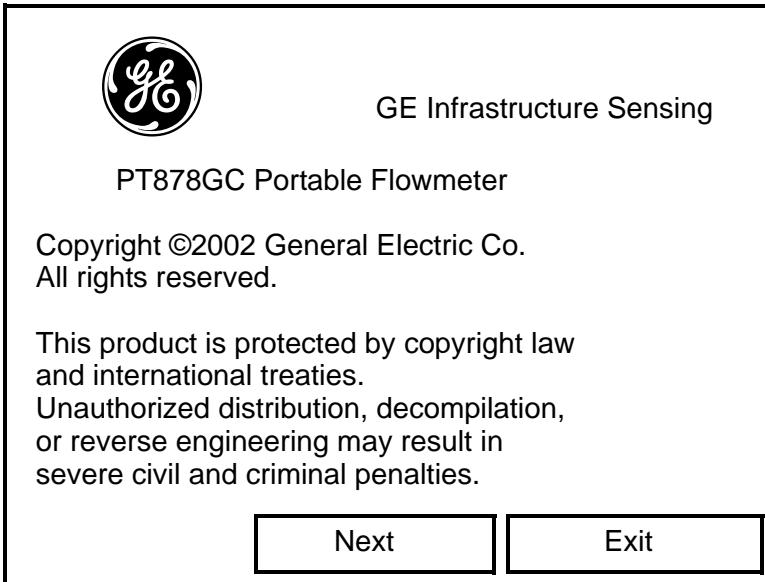

**Figure 6-17: The About Window**

To find out details about your specific software version, press Next ([F2]). To return to Operate Mode, press [ESC] or Exit ([F3]).

# Chapter 7

## Programming Meter Settings

---

Along with display formats and site data, PT878GC users can program global settings for the meter that suit their individual preferences. The global settings include:

- English or Metric measurement units
- Battery power
- Date and time parameters and appearance
- Screen contrast
- Backlight timeout
- Language settings
- Infrared communications settings
- Resetting forward and reverse totals
- User tables
- Printing and capturing screens

## Entering the Meter Menu

To enter the Meter Menu, press the [MENU] key at the lower right of the PT878GC keypad. The Main Menu replaces the Status Bar at the top of the screen. Press the [▶] arrow key twice to scroll from the Site Menu to the Meter Menu. At the Meter Menu, press [ENTER]. The screen appears similar to Figure 7-1 below. While programming, refer to Figure A-8 on page A-8 of Appendix A, *Menu Maps*.

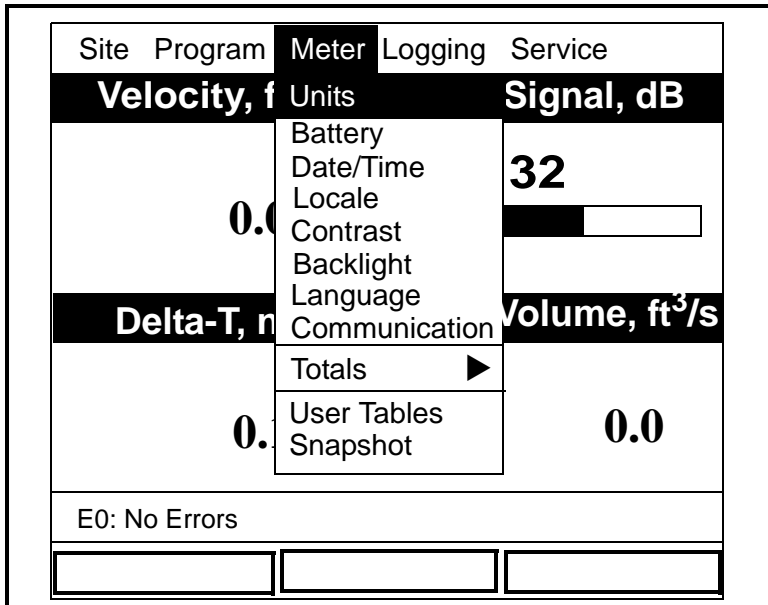

Figure 7-1: The Meter Menu

To scroll to a particular option, press the [▼] or [▲] arrow keys until you reach the option. Then press [ENTER] to open the option window.

When entering parameters in an option, press:

- The [▼] key to step through the available parameters
- The [▲] key to scroll back to a previously entered parameter
- The [F2] key (Cancel) or the [ESC] key to exit an option at any time and return to Operate Mode without changing the parameters.

## Selecting Measurement Units

The first option, Units, enables you to select either English or Metric units as global measurement units for the PT878GC. The selected units then become the default settings for every measurement that has the option for metric/English units. In addition, you can select the type of pressure units displayed. To select the units, scroll to the Units entry on the Meter menu and press [ENTER]. The Meter Settings window opens, as shown in Figure 7-2 below.

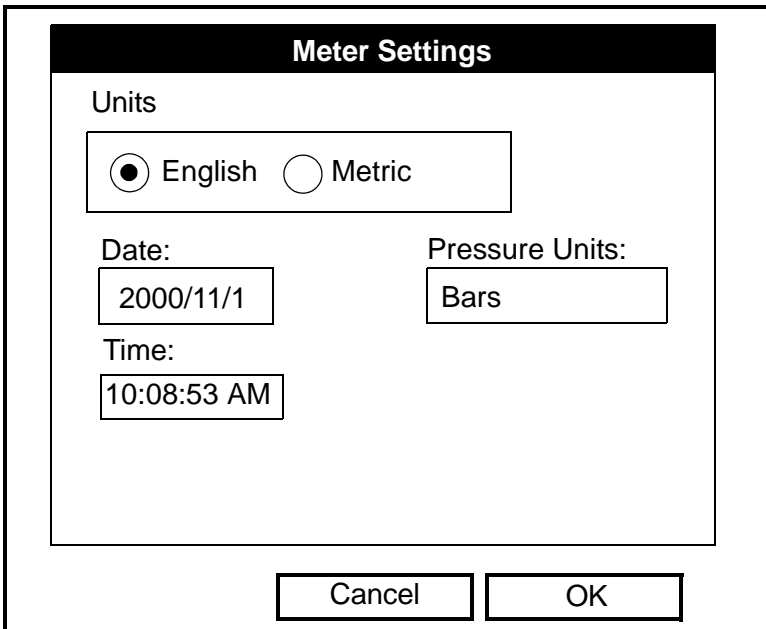

The screenshot shows a window titled "Meter Settings" with a black header. Below the header, the "Units" section contains two radio buttons: "English" (selected) and "Metric". Below this, there are three input fields: "Date:" with the value "2000/11/1", "Time:" with the value "10:08:53 AM", and "Pressure Units:" with the value "Bars". At the bottom of the window are two buttons: "Cancel" and "OK".

Figure 7-2: The Meter Settings Window

1. At the Units prompt, use the [◀] and [▶] keys to scroll between English and Metric units.
2. Press [ENTER] to confirm the choice.
3. To enter the Pressure Units prompt, press the [▼] key and then the [▶] keys to reach the prompt.

## Selecting Measurement Units (cont.)

- a. Press [ENTER] to open the drop-down menu.
  - b. Use the [▼] and [▲] arrow keys to scroll to the desired choice:
    - PSIA
    - KPA
    - Bars
    - MMGH
  - c. Press [ENTER] to confirm the entry.
- To confirm the entries and return to Operate Mode, press [F3] (OK).
  - To leave the window without confirming the entries, press [F2] (Cancel) or the [ESC] key.
- In either case, the meter returns to Operate Mode.

## The Battery Charger

The Battery option allows you to monitor the current run time and status of the internal rechargeable batteries, as well as to condition NiCad batteries to maintain the maximum life possible. Conditioning NiCad batteries (a process that can take up to 12 hours for a fully charged pack) discharges the pack completely and then performs a fast charge.

**Note:** *When conditioning the batteries, be sure you have plugged the AC adapter into the PT878GC and pressed the power key. NiMH batteries normally do not require conditioning.*

To open the option window:

1. From the Meter menu, scroll to the Battery entry and press [ENTER]. The Battery Charger window opens, as shown in Figure 7-3 below.
2. If you wish to open the Part Number window, press [ENTER]. You can choose from a 1.8 Ahr NiCd battery (part number 200-058) or a 3.0 Ahr NiMH battery (part number 200-081). Scroll to the battery type you have installed and press [ENTER].

**Note:** *If you do not set the correct battery type in the Part Number window, the battery continues to function, but the battery status icons (see page 2-5) will not be accurate.*

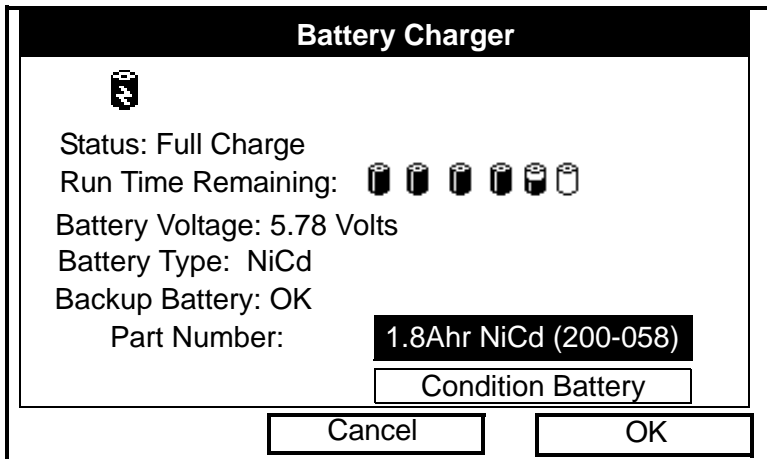

Figure 7-3: The Battery Charger Window



## The Battery Charger (cont.)

3. To condition the batteries, press the [ENTER] key. The “Condition Battery” window should now read “Stop.” The status line should change to “Discharging.” (Updating the status could take up to 30 seconds.)

**Note:** *It is advisable to condition NiCad batteries when their run time is reduced to 50% of their previous run time.*

4. To stop the discharge cycle, press the [ENTER] key and the “Condition Battery” window reappears. The status now changes to “On Charger.”
5. Press [F3], OK, to return to Operate Mode.

---

## Entering Date and Time

In Operate mode, the Status Bar displays the current date and time above the measurements in the upper right corner of the screen. The Date/Time option allows you to set the date or time, which are required for correct data logging operation.

To set the time:

1. From the Meter menu, scroll to the Date/Time entry and press [ENTER]. The Meter Settings window reopens, as shown in Figure 7-2 on page 7-3.
2. From the Units option, press the [▼] key once to reach the date text box. This box displays the current meter date.
3. Press [ENTER] to enter the text window. The meter highlights the first number. Use the [◀] and [▶] keys to scroll to any number you wish to change.
4. Two alternatives are available to change a highlighted number:
  - Use the numeric keys to enter the desired number.
  - Use the [▼] or [▲] arrow keys to scroll, in 1-digit increments, to the desired number. (For example, if the text box highlights 09, pressing the [▼] key twice changes the number to 07.) You can scroll from 01 to 12 for the month and from 01 to 31 for the day (depending on the number you have selected for the month).

In either case, press [ENTER] to confirm the entry.

## Entering Date and Time (cont.)

To set the date:

1. From the date text box, press the [▼] key once to scroll to the time text box. This box displays the current meter time.
2. Press [ENTER] to enter the text box. The meter highlights the first number. Use the [◀] and [▶] keys to scroll to any number you wish to change.
3. Two alternatives are available to change a highlighted number:
  - Use the numeric keys to enter the desired number.
  - Use the [▼] or [▲] arrow keys to scroll, in 1-digit increments, to the desired number. (For example, if the text box highlights 09, pressing the [▼] key twice changes the number to 07.) You can scroll from 01 to 12 for the hour and from 01 to 59 for the minute and second inputs.
4. In either case, press [ENTER] to confirm the entry.

Pressing the [▼] or [▲] arrow keys causes the meter to scroll within the Meter Settings options.

- To confirm the entries and return to Operate Mode, press [F3] (OK).
- To leave the window without confirming the entries and return to Operate mode, press [F2] (Cancel) or the [ESC] key.

## Changing Date and Time Appearance (Locale)

In addition to setting the correct date and time, you can also change its presentation to suit local preferences. You can select a time display of AM/PM or 24-hour time

To alter the time and date display:

1. From the Meter menu, scroll to the Locale entry and press [ENTER]. The Display Options window opens on the Format tab, as shown in Figure 7-4 below. To step through each parameter, press the [▼] key.

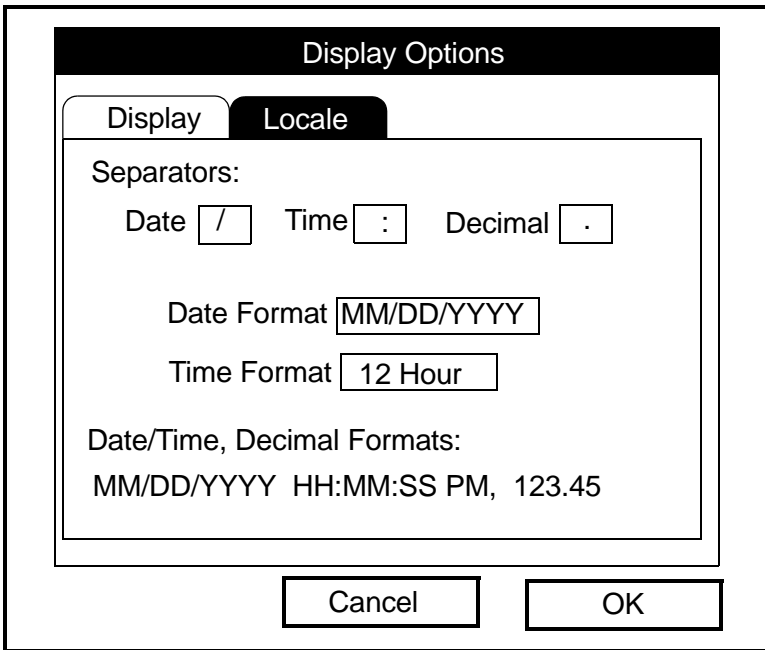

Figure 7-4: Format Tab in the Display Options Window

## Changing Date and Time Appearance (cont.)

2. The first series of prompts asks you to select separator symbols for the date, time and decimal. You can choose from a dash, comma and slash (/) for the date; from a period and colon for the time; and from a period or comma for the decimal place. For each symbol type:
  - a. Press [ENTER] to open the drop-down menu.
  - b. Use the [▼] or [▲] arrow keys to scroll to the desired format.
  - c. Press [ENTER] to confirm your entry.
3. The next prompt asks you to select the date format.
  - a. Press [ENTER] to open the drop-down menu. Three options are available:
    - YYYY/MM/DD (year/month/day)
    - MM/DD/YYYY (month/day/year)
    - DD/MM/YYYY (day/month/year)
  - b. Use the [▼] or [▲] arrow keys to scroll to the desired format.
  - c. Press [ENTER] to confirm your entry.
4. The PT878GC now asks you to select whether you want the time presented in a 12-hour format (for example, 11:53:23 PM) or in a 24-hour format (23:53:23).
  - a. Press [ENTER] to open the drop-down menu.
  - b. Use the [▼] or [▲] arrow keys to scroll to the 12-hour or 24-hour entry.
  - c. Press [ENTER] to confirm your entry.

---

## Changing Date and Time Appearance (cont.)

A line at the bottom, the Date/Time, Decimal Formats, displays how the format and separator selections will appear on the screen.

Pressing the [▼] arrow key returns the PT878GC to the Locale tab.

- To confirm the entries and return to Operate Mode, press [F3] (OK).
- To leave the window without confirming the entries and return to Operate mode, press [F2] (Cancel) or the [ESC] key.

## Adjusting the Contrast

For more comfortable viewing in a particular environment, the PT878GC enables you to adjust the screen contrast. To adjust the screen contrast:

1. From the Meter menu, scroll to the Contrast entry and press [ENTER]. The Display Options window opens on the Display tab, as shown in Figure 7-5 below. (From the Format tab, press the [◀] key to move to the Display tab.) To step through each parameter, press the [▼] key.

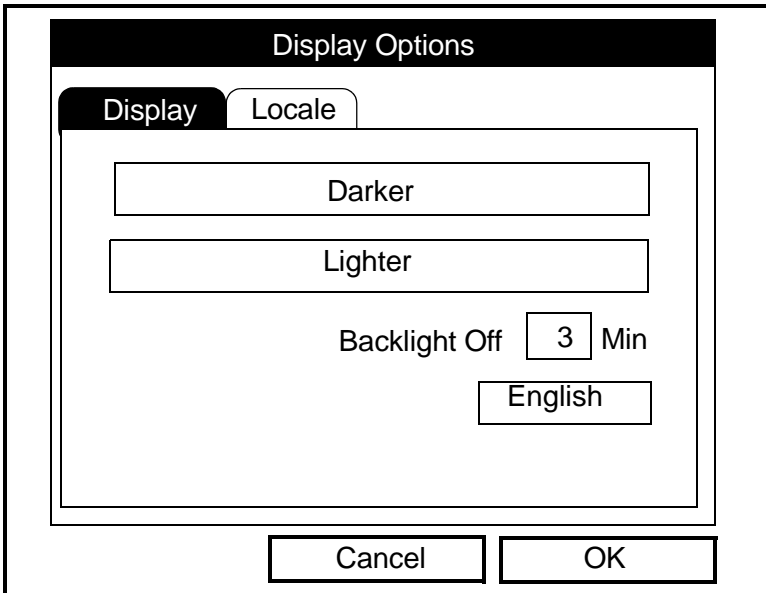

Figure 7-5: Display Tab in the Display Options Window

2. Scroll to the Darker or Lighter box as desired.
3. Press the [ENTER] button repeatedly until the screen has the desired contrast.

**Note:** *If you find the screen has become too light or too dark, scroll to the other box and press [ENTER] until you have adjusted the screen to your satisfaction.*

---

## Adjusting the Contrast (cont.)

- To confirm the entries and return to Operate mode, press [F3] (OK).
- To leave the window without confirming the entries and return to Operate mode, press [F2] (Cancel) or the [ESC] key.



## Setting Backlight Timeout

By using the Backlight Timeout option, you can set a specified time that the PT878GC backlight will remain on before turning itself off. Automatic turnoff enables the PT878GC to conserve battery power.

To set the backlight timeout:

1. From the Meter menu, scroll to the Backlight entry and press [ENTER]. The Display Options window opens on the Display tab, as shown in Figure 7-5 on page 7-12.
  2. Press the [▼] key three times to reach the Backlight Off text box.
  3. Then press [ENTER] to enter the box.
  4. Use the numeric keys to enter the number of minutes that the backlight remains on (from 0 to 60).
  5. Press [ENTER] to confirm the entry.
- To confirm the entries and return to Operate mode, press [F3] (OK).
  - To leave the window without confirming the entries and return to Operate mode, press [F2] (Cancel) or the [ESC] key.

**Note:** *You can turn the backlight on or off at any time by pressing the power switch for 1 second.*

## Changing Communications Parameters

On occasion, you might need to change the parameters by which the PT878GC communicates with a PC over the wireless infrared interface. To check or change these parameters:

1. From the Meter menu, scroll to the Communications entry and press [ENTER]. The Communications window appears similar to Figure 7-6 below.

The screenshot shows a window titled "Communications" with the following settings:

- Node ID: 2
- Comm Interface:  IrDA  IR 232
- Baud Rate: 9600 bps
- Parity: None
- Stop Bits:  1  2
- Data Bits:  7  8

At the bottom of the window are two buttons: "Cancel" and "OK".

Figure 7-6: The Communications Window

2. The first prompt asks for the node identification number, which can be any number from 1 to 240.

**IMPORTANT:** *Do NOT change the node ID unless instructed by GE Infrastructure Sensing.*

- a. Press [ENTER] to open the text box.
- b. Use the numeric keys to enter the node ID.
- c. Press [ENTER] to confirm the entry.

---

## Changing Communications Settings (cont.)

3. The next prompt asks you to select the communications interface from two options: IrDA (Infrared Data Association) and the IR232 virtual interface. You must use IrDA when using an IR printer or transfer application such as QuickBeam. Use the [◀] and [▶] keys to scroll to the desired selection, and press [ENTER].

**Note:** *For more information on loading software updates via the infrared interface, see Chapter 9, Servicing the PT878GC, page 9-43.*

If you have selected IrDA, you have completed entering data in this window. However, if you have selected IR232, the PT878GC asks for four more parameters.

**IMPORTANT:** *Using IR232 requires the following parameters:*

- *Baud Rate -- 9600*
- *Parity -- None*
- *Stop Bits -- 1*
- *Data Bits -- 8*

4. The program now asks for the baud rate. The default rate is 9,600 bps.
  - a. Press [ENTER] to open the drop-down menu.
  - b. Use the [▼] or [▲] arrow keys to scroll to the desired rate, from 300 to 115.2K bps.
  - c. Press [ENTER] to confirm the entry.
5. The next prompt asks for the parity from five options: None, Mark, Space, Even or Odd. The default parity is None.
  - a. Press [ENTER] to open the drop-down menu.
  - b. Use the [▼] or [▲] arrow keys to scroll to the desired parity.
  - c. Press [ENTER] to confirm the entry.

---

## Changing Communications Settings (cont.)

6. The next prompt asks you to select either one or two stop bits. The default number is one. Use the [◀] and [▶] keys to scroll to the desired number, and press [ENTER].
  7. The final prompt asks you to select either seven or eight data bits. The default number is 8. Use the [◀] and [▶] keys to scroll to the desired number, and press [ENTER].
- To confirm the entries and return to Operate mode, press [F3] (OK).
  - To leave the window without confirming the entries and return to Operate mode, press [F2] (Cancel) or the [ESC] key.

## Resetting Forward and Reverse Totals

On occasion, it might be necessary to clear and reset the forward and reverse totals computed by the Forward and Reverse Totalizers. To reset the totals:

1. From the Meter menu, scroll to the Totals entry and press [ENTER]. The window now appears similar to Figure 7-7 below.

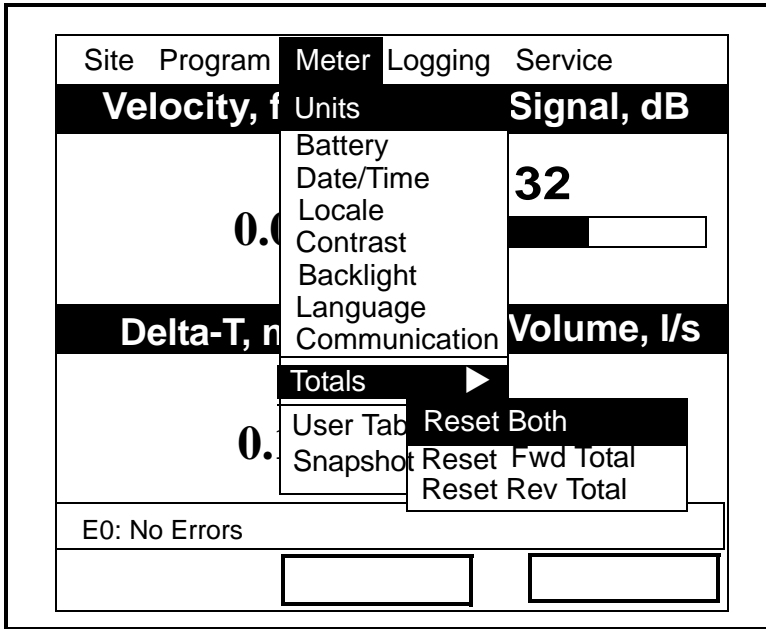

Figure 7-7: The Resetting Totals Menu

2. Use the [▼] or [▲] arrow keys to choose the total to be reset.
3. Press [ENTER] to reset the total(s).

The meter resets the selected total(s) to 0.0.

## Setting Up User Tables

When you program user functions (see page 4-46), you can also support them with up to six user tables of non-linear or empirical data. To program one or more user tables:

1. From the Meter menu, scroll to the User Tables entry and press [ENTER]. The window now appears similar to Figure 7-8 below.

The screenshot shows a window titled "User Function Tables". Inside the window, there are four input fields arranged vertically:

- The first field is labeled "Table" and contains the text "Table 1".
- The second field is labeled "Table ID" and contains the text "UserTable1".
- The third field is labeled "# Data Points" and is currently empty.
- The fourth field is labeled "Max Points" and is currently empty.

Below these fields is a button labeled "Edit Tables". At the bottom of the window, outside the main content area, are two buttons: "Cancel" on the left and "OK" on the right.

Figure 7-8: The User Tables Window

2. The first prompt asks you to select the table to be programmed.
  - a. Press [ENTER] to open the drop-down menu.
  - b. Use the [▼] or [▲] arrow keys to scroll to the table you wish to program.
  - c. Press [ENTER] to confirm the entry.

## Setting up User Tables (cont.)

3. The next step is to create a Table ID.
  - a. Press [ENTER] to open the window. The screen now appears similar to Figure 7-9 below.

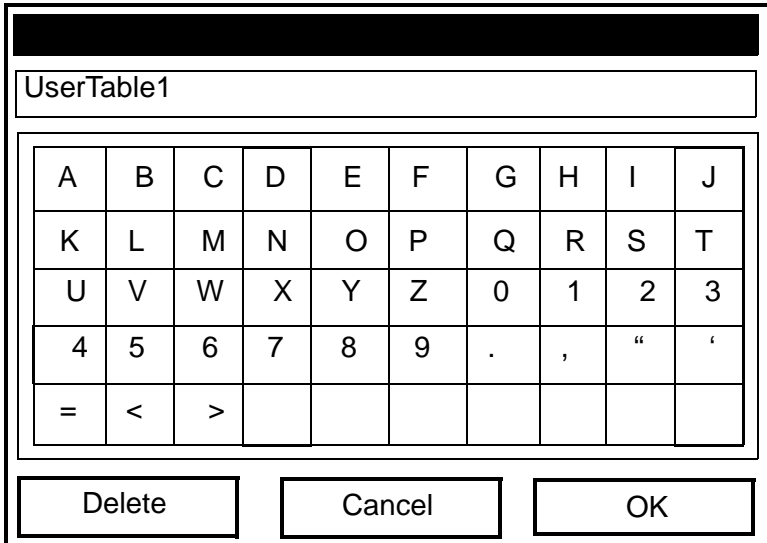

**Figure 7-9: The Text Creation Window**

- b. Use the four arrow keys to scroll to the desired letter or symbol, and press [ENTER] to add the letter to the label.

**Note:** *Pressing [SEL] causes the screen to alternate between a set of upper-case (capital) letters and a set of symbols. Use both screens to create the desired label.*

- c. Repeat this procedure for each letter or symbol you wish to add to the label. (The Table ID window can display up to 15 characters.) If you wish to delete a letter, press [F1] (Delete) to erase each letter or symbol, from right to left on the label.
      - d. When you have completed the label, press [F3] (OK) to confirm the label, or [F2] (Cancel) to leave the window without adding the label.

---

## Setting up User Tables (cont.)

4. The final prompt asks you to enter or change data in the user table.
  - a. Press [ENTER] to open the window. The screen appears similar to Figure 7-10 below.

Edit User Table 1		
<input type="text"/>		
	UserTable1	Y
1		
2		
3		
4		
5		

Cancel      OK

**Figure 7-10: The Edit User Table Window**

- b. Use the four arrow keys to move to the desired entry in the table.
- c. Press [ENTER]. Then use the numeric keys to enter the desired data, which appears in the right corner of the window above the table.
- d. Press [ENTER] to confirm the data, which then appears in the appropriate slot in the table.



## Setting up User Tables (cont.)

- e. Repeat steps b, c and d on page 7-21 until you have completed entering data for the table.
- f. When you have finished, press [F3] (OK) to confirm the entries or [F2] (Cancel) to leave the window without confirming the table.

The program returns to the Edit Tables window.

- To confirm the entries and return to Operate mode, press [F3] (OK).
- To leave the window without confirming the entries and return to Operate mode, press [F2] (Cancel) or the [ESC] key.

---

## Taking a Bitmap Capture of a Current Screen

The Snapshot option enables you to take a “screen capture” of the current screen in bitmap format (.bmp) for display or storage in a Windows-based PC. To take a “snapshot” of the screen:

1. From the Meter menu, scroll to the Snapshot entry and press [ENTER].
2. A drop-down menu appears, asking if you want to send the capture to a printer or to a file, or to turn the option off. If you select “To File,” an icon of a camera (see page 2-10) appears at the far right of the status tray, indicating that you have activated the Snapshot option. If you select “To Printer,” an icon of a printer appears.
3. To capture a screen, press the “.” (decimal) button in the lower left corner of the keypad twice. The meter beeps, indicating that it has made a screen capture.

The “To Printer” option enables you to send a picture of the current screen to an infrared printer. After capturing a screen, the PT878GC shows a message indicating that its infrared scanner is looking for a receiving device. (If the scanner finds no device, a window appears stating that the meter can find no device. If it finds more than one compatible infrared device within range, it asks you to select the desired device.) If successful, the PT878GC returns to Operate Mode, while the printer prints out the current screen.

To locate the screen capture with the “To File” option, open the Drive Manager (see page 6-14). The captured file is listed as “Screen 0X.bmp”. To transfer the file to a PC, follow the instructions in “Transferring a File to a PC” on page 6-16.

# Chapter 8

## Logging Data

---

A powerful and flexible feature of the PT878GC is data logging. The meter enables you to choose up to 12 parameters to log. You can also select the start time and date, end time and date, and time interval. Logs can run one at a time or simultaneously. Error and circular logs are also available. The logged data is internally stored in battery-backed-up memory. A fixed amount of memory is assigned to data logging. The frequency of the time interval, the length of the log run, and the number of logs affect the amount of memory required for a particular log. For example, a log that records every 5 seconds will use up more memory than a log that records every 5 minutes for a given amount of time. Once you make your data logging selections, the PT878GC enables you to view the amount of memory left. You may also stop logging or view logged data while or after data is logged.

This section describes:

- How to enter the Logging Menu.
- How to set up a new log.
- How to view the data logger memory.
- How to start, stop or pause logging

## Entering the Logging Menu

To enter the Logging Menu, press the [MENU] key at the lower right of the PT878GC keypad. The Main Menu replaces the Status Bar at the top of the screen. Press the [▶] arrow key three times to scroll from the Site Menu to the Logging Menu. At the Logging Menu, press [ENTER]. The screen appears similar to Figure 8-1 below. Refer to Figure A-9 on page A-9 of Appendix A, *Menu Maps*.

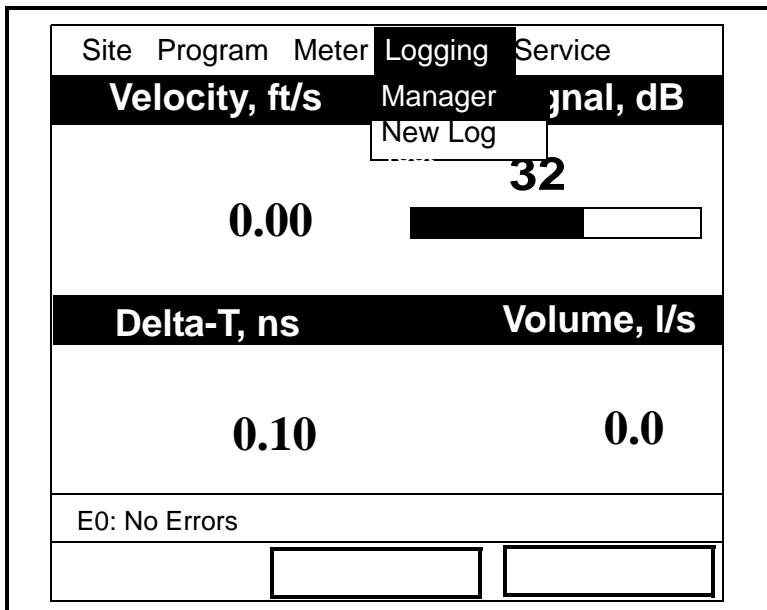

**Figure 8-1: The Logging Menu**

To scroll to a particular option, press the [▼] or [▲] arrow keys until you reach the option. Then press [ENTER] to open the option window.

When entering parameters in an option, press:

- The [▼] key to step through the available parameters
- The [▲] key to scroll back to a previously entered parameter
- The [F2] key (Cancel) or the [ESC] key to exit an option at any time and return to Operate Mode without changing the parameters.

## The Log Manager

The Log Manager offers users a way to check the status and memory size of all the logs currently pending, running or finished. To select Log Manager, scroll to the Manager entry on the Logging Menu and press [ENTER]. The screen appears similar to Figure 8-2 below. The right section of the screen supplies information for the log highlighted in the list on the left. You can use the [▼] and [▲] arrow keys to scroll to a particular log and display information pertaining to that log.

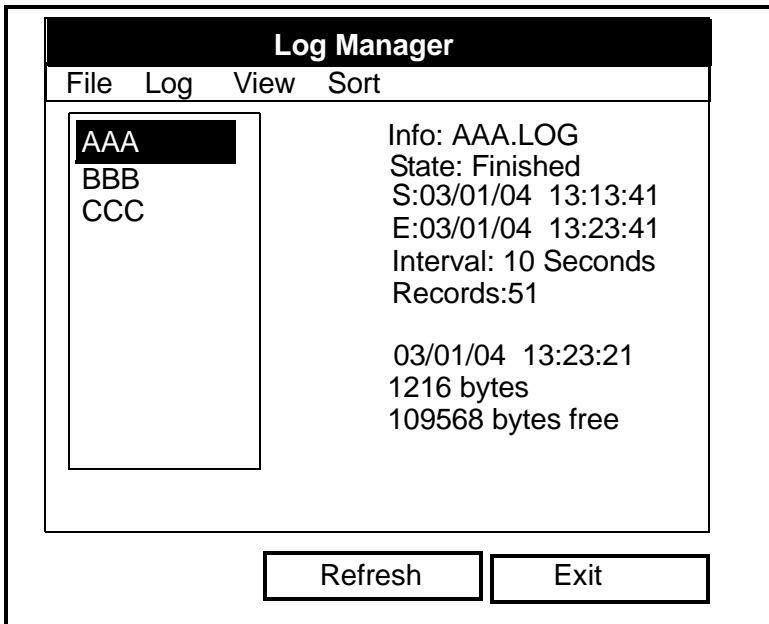

Figure 8-2: The Log Manager Window

To access the menu for the Log Manager, press the [MENU] key. The cursor highlights the File Menu in the upper left corner. Use the [◀] and [▶] keys to scroll to the desired menu, and press [ENTER] to open the menu.

## The File Menu

The File Menu allows you, not only to create new logs, but also to copy, rename or delete logs, as well as to print them or transfer them to a PC. To open the File menu from the Log Manager, press the [MENU] key and then [ENTER]. The screen appears similar to Figure 8-3 below.

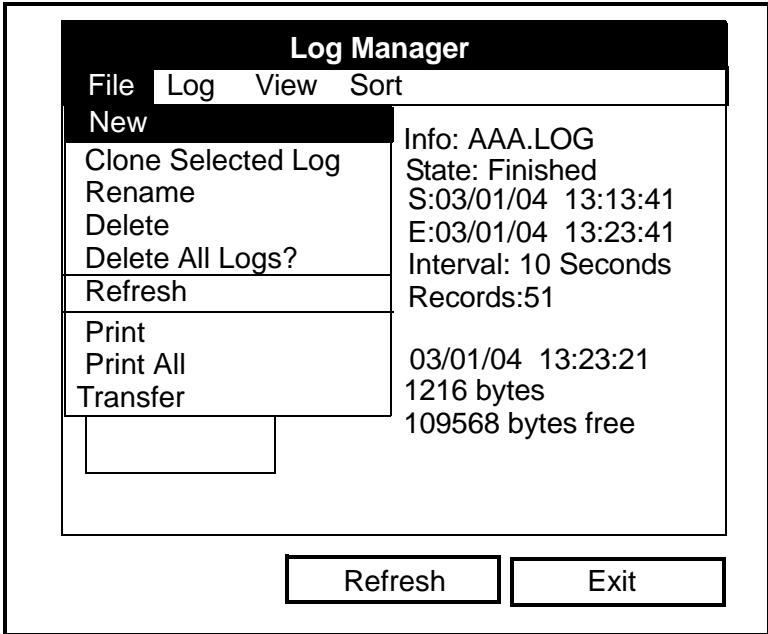

Figure 8-3: File Menu in the Log Manager

## Setting up a New Log

The New Log option enables you to create and set up parameters for a new log. You can access this option in two ways:

- by scrolling to the New Log option in the Logging Menu (as shown in Figure 8-1 on page 8-2) and pressing [ENTER], or
- by scrolling to the New option in the File menu of the Log Manager (as shown in Figure 8-3 on page 8-4) and pressing [ENTER].

In either case, the Create New Log screen appears similar to Figure 8-4 below. Use the four arrow keys to scroll to the desired letter or number, and press [ENTER]. Repeat this procedure until you have created the desired log name with up to eight characters. (Press [F1], Delete, to remove any unwanted letters or numbers.) When you have finished, press [F3], OK, to confirm the entry.

Create New Log							
A	B	C	D	E	F	G	H
I	J	K	L	M	N	O	P
Q	R	S	T	U	V	W	X
Y	Z	0	1	2	3	4	5
6	7	8	9				
Delete		Cancel			OK		

Figure 8-4: The New Log Window

The PT878GC now asks for log formatting and measurements. The screen appears similar to Figure 8-5 on the next page.

## Setting up a New Log (cont.)

The screenshot shows a dialog box titled "General Log Format Window". It has two tabs: "General" (which is active) and "Measurements". The "General" tab contains the following controls:

- Log Name:** A text box containing "10SEC.LOG".
- Format:** Two radio buttons: "Linear" (selected) and "Circular".
- Type:** Two radio buttons: "Standard" (selected) and "Error".
- Start Date/Time:** Two text boxes: the first contains "2004/11/01" and the second contains "01:38:08".
- End Date/Time:** Two text boxes: the first contains "2004/11/01" and the second contains "09:38:08".
- Logging Interval:** A text box containing "10" followed by the text "secs".

At the bottom of the dialog box are two buttons: "Cancel" and "Activate".

Figure 8-5: The General Log Format Window

To step through each parameter, press the [▼] key.

1. The first prompt asks you to choose between a linear or circular format for the log. (A linear log stops when it reaches a specified end time or the PT878GC runs out of memory, while a circular log runs continuously until manually stopped.)
  - a. Use the [◀] and [▶] keys to scroll to the appropriate radio button.
  - b. Press [ENTER] to confirm your selection.
2. The next prompt asks you to choose whether the log is to be a standard log, recording specified data, or an error log (one which records error conditions).
  - a. Use the [◀] and [▶] keys to scroll to the appropriate radio button.
  - b. Press [ENTER] to confirm your selection.



## Setting up a New Log (cont.)

3. The next prompt asks for the starting date and time.
  - a. Press [ENTER] to enter the text box. The meter highlights the first number. Use the [◀] and [▶] keys to scroll to any number you wish to change, or the [▶] key to scroll to the time box.
  - b. Two alternatives are available to change a highlighted number:
    - Use the numeric keys to enter the desired number.
    - Use the [▼] or [▲] arrow keys to scroll, in 1-digit increments, to the desired number. (For example, if the text box displays 09, pressing the [▼] key twice changes the number to 07.) You can scroll from 01 to 12 for the month and from 01 to 31 for the day (depending on the number you have selected for the month).
  - c. In either case, press [ENTER] to confirm the entry.
4. Follow the same procedure to enter the end date and time.
5. The final prompt in this window asks for the logging interval.
  - a. Press [ENTER] to open the text box.
  - b. Use the numeric keys to enter the desired interval in seconds.
  - c. Press [ENTER] to confirm the entry.
6. You have completed entering parameters in this window. To select the measurements,
  - a. Press the [▼] key to return to the Format prompt.
  - b. Then press the [▲] key to return to the General tab.
  - c. Finally, press the [▶] key to move to the Measurements tab, and press [ENTER]. The Measurements window appears similar to Figure 8-6 on the next page.

## Setting up a New Log (cont.)

The screenshot shows a window titled "Log Measurements Window" with two tabs: "General" and "Measurements". The "Measurements" tab is active. Below the tabs is a table with 6 rows and 2 columns. Each cell in the table contains the text "NO UNIT". Below the table are two buttons: "Cancel" and "Activate".

General	Measurements
NO UNIT	NO UNIT
NO UNIT	NO UNIT
NO UNIT	NO UNIT
NO UNIT	NO UNIT
NO UNIT	NO UNIT
NO UNIT	NO UNIT

Cancel      Activate

**Figure 8-6: The Log Measurements Window**

To step through each entry, press the [▼] key.

1. Press [ENTER] to open the first entry. The Select Measurement window opens, as shown in Figure 8-7 on the next page.

## Setting up a New Log (cont.)

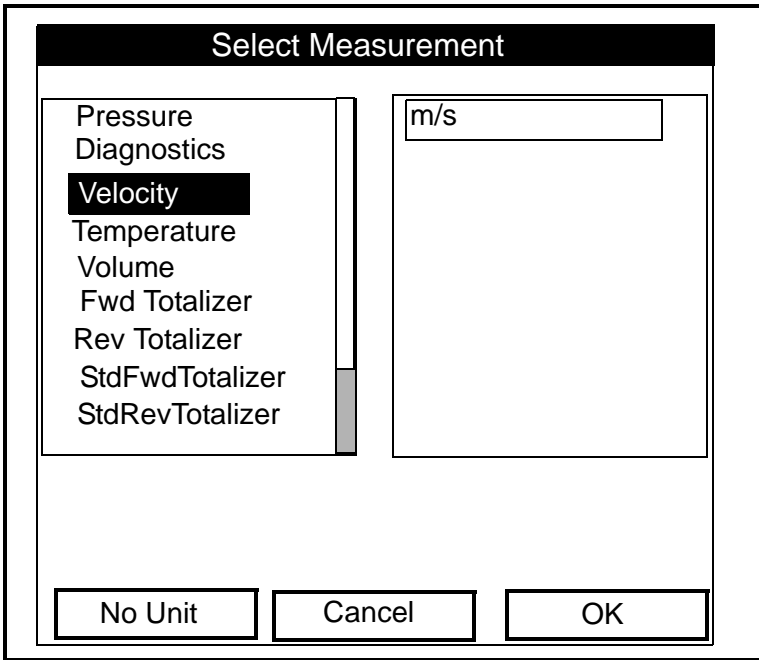

**Figure 8-7: The Select Measurement Window**

2. Scroll to the desired output type.
3. Press [SEL] to confirm your selection.
4. The prompt then moves to a list of unit types. (The available units depend on the selection made at the Data Source prompt.) Scroll to the desired output unit.
5. Press [F3] (OK) to confirm your selection.
6. You can repeat this procedure for up to 12 different parameters.
7. When you have finished, press [F2] (Cancel) to cancel the entries, or [F3] (Activate) to confirm the entries and start the log.

If you started the log from the New Log option, the PT878GC returns to Operate Mode; if you started it from within the Log Manager, the meter returns to the Log Manager.

## Copying (Cloning) a Selected Log

In the Clone Selected Log option, you can copy the parameters of a particular log, modify the parameters, and start the copy. To copy a log:

1. First, select the log you wish to copy in the Log Manager (shown in Figure 8-3 on page 8-4).
2. Then open the File menu, scroll to the Clone Selected Log option, and press [ENTER].
3. The Create New Log window (shown in Figure 8-4 on page 8-6) opens. Follow the procedure discussed on page 8-5 to create a log name, and press [F3] (OK) to confirm the name.
4. The General Log Format window (shown in Figure 8-5 on page 8-7) opens. Follow the procedure discussed on pages 8-7 and 8-8 to change any settings.

**Note:** *Unless otherwise specified, the cloned log always begins at the current date and time, and ends after the period of time used by the original log.*

5. If you wish, scroll to the Measurements window (shown in Figure 8-6 on page 8-8) and follow the procedure discussed on pages 8-8 and 8-9 to modify any parameters.
6. When you have completed modifying the log parameters, press [F2] (Cancel) to cancel the log or [F3] (Activate) to confirm and start the new log.

The PT878GC returns to the Log Manager, which now displays the status of the cloned log.

**Note:** *Some changes in the site file could prevent log cloning.*

## Renaming a Log

To rename a log:

1. First, select the log you wish to rename in the Log Manager (shown in Figure 8-3 on page 8-4).
2. Then open the File menu, scroll to the Rename option, and press [ENTER].
3. The Rename Log window opens. (Except for the heading, the window is identical to the Create New Log window shown in Figure 8-4 on page 8-5.) Follow the procedure discussed on page 8-5 to create a log name, and press [F3] (OK) to confirm the name.

The PT878GC returns to the Log Manager, which highlights the renamed log.

## Deleting a Log

To delete a log:

1. First, select the log you wish to delete in the Log Manager (shown in Figure 8-3 on page 8-4).
2. Then open the File menu, scroll to the Delete option, and press [ENTER].
3. A delete confirmation window opens, as shown in Figure 8-8 on the next page. Press [F2] (No) to stop the deletion, or [F3] (Yes) to delete the log.

The Log Manager reappears, with the specified log deleted.

## Deleting a Log (cont.)

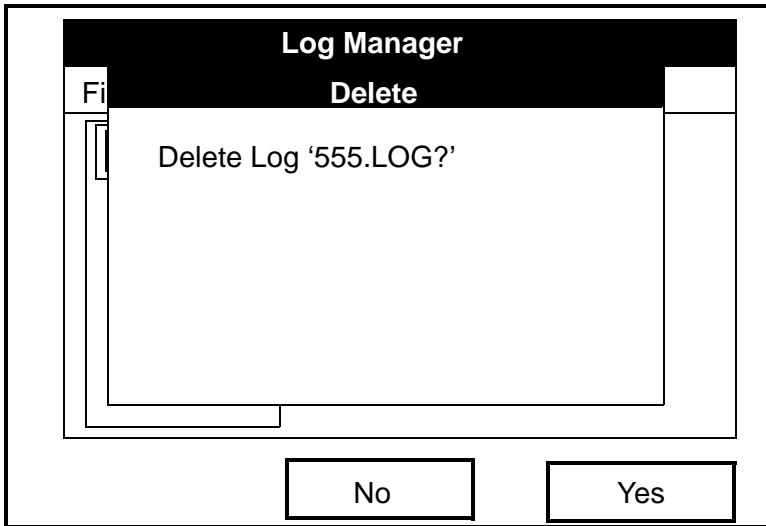

Figure 8-8: The Delete Confirmation Window

### Deleting All Logs

To clear the Log Manager and memory of all logs, open the File menu, scroll to the Delete All Logs option, and press [ENTER]. A window opens, asking, "Delete All Logs?" Press [F2] (No) to stop the deletion, or [F3] (Yes) to delete the logs.

**IMPORTANT:** *This step cannot be undone!*

A blank Log Manager appears. All logs have been deleted.

### Refreshing a Log

You can refresh a log (updating the display with the most current information) in one of two ways:

- Press [F2], Refresh, to refresh the highlighted log.
- From the File Menu, scroll to the Refresh option and press [ENTER].

The updated information on the highlighted log appears in the window on the right.

## Printing a Log

To print a file from the Log Manager:

1. Highlight the desired log in the window on the left of the Log Manager.
2. Press [MENU], scroll to the Print option, and press [ENTER].

The PT878GC shows a message indicating that its infrared sensor is looking for a printer. (If the sensor finds no printer, a window appears with this message. If it finds two printers within its range, it asks you to select the desired device.) If successful, the PT878GC returns to the Log Manager, while the printer prints out the log.

## Transferring a Log to a PC

To upload a log to a PC:

1. Check that the Communications option (see page 7-15) has been set to the IrDA protocol.

**Note:** *For Windows NT4.0, check that the QuickBeam software (available through the path C:\Program Files\QuickBeam Suite) is running, and that the IR beam on the PT878GC has access to the IR sensor connected to the PC port.*

2. Highlight the desired log in the left window of the Log Manager.
3. Press [MENU], scroll to the Transfer option, and press [ENTER].

The screen shows a message indicating that the PT878GC is searching for an infrared device. (If the sensor finds no device, a window appears with this message, and asks if you want to try again.) If it finds a device, it sends another message indicating that it is uploading the log. (The meter also displays a message if the upload fails.) When the upload is complete, the meter returns to the Log Manager. The PC holds the transferred log in a C\Ir\_Inbox folder (C:\Ir\_Inbox for Windows NT, C:\My Received Files for Windows 98, or Desktop for Windows 2000). You can open the file on the PC using the PanaLog Viewer (available at [www.gesensing.com](http://www.gesensing.com)) and export it in Microsoft Excel format.

**Note:** *You cannot download log files back to the PT878GC.*

## The Log Menu

The Log Menu allows you to pause, restart or end any or all logs that are currently pending or running. (However, you cannot restart any finished logs, even if they were finished before the programmed end time.) To open the Log Menu in the Log Manager, press [MENU]. Scroll to the Log option, and press [ENTER]. The window appears similar to Figure 8-9 below.

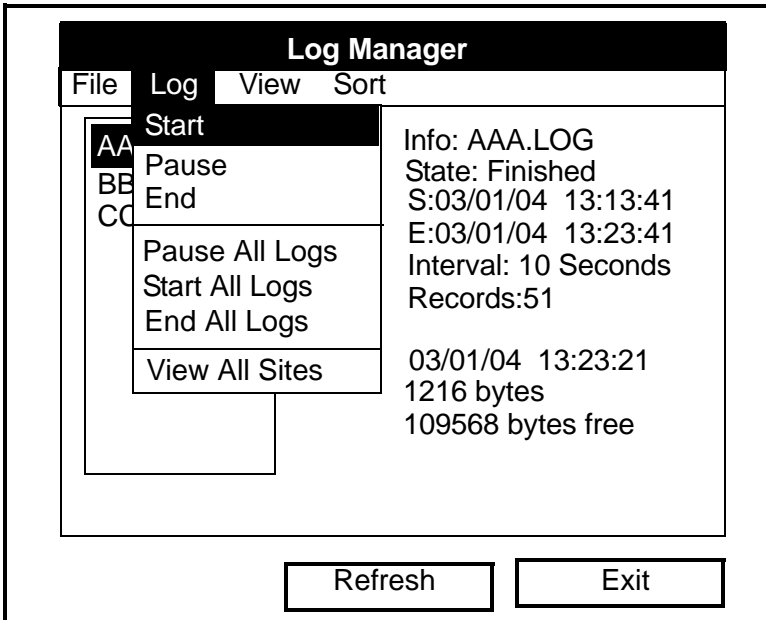

Figure 8-9: The Log Menu in the Log Manager



## Stopping (Pausing) a Log

To stop a log that is currently pending or running,

1. First, select the log you wish to pause in the Log Manager (shown in Figure 8-2 on page 8-4).
2. Then open the Log menu, scroll to the Pause option, and press [ENTER].

The PT878GC returns to the Log Manager, which displays the highlighted log with “Paused” in the State line.

## Restarting a Log

To restart a paused log:

1. First, select the log you wish to restart in the Log Manager (shown in Figure 8-2 on page 8-4).
2. Then open the Log menu, scroll to the Start option, and press [ENTER].

The PT878GC returns to the Log Manager, which displays the highlighted log with a status of “Pending” or “Running.”

## Ending a Log

To end a log:

1. First, select the log you wish to end in the Log Manager (shown in Figure 8-2 on page 8-4).
2. Then open the Log menu, scroll to the End option, and press [ENTER].

The PT878GC returns to the Log Manager, which displays the highlighted log with a status of “Finished.” The space not used by the finished log is freed for reuse.

**Note:** *You cannot restart a finished log. You must create a new log with the same parameters.*

## **Pausing All Logs**

To pause all logs that are currently pending or running, open the Log menu, scroll to the Pause All Logs option, and press [ENTER]. The PT878GC returns to the Log Manager, which displays all logs programmed to run now or in the future with a status of “Paused.”

## **Restarting All Logs**

To restart all paused logs, open the Log menu, scroll to the Start All Logs option, and press [ENTER]. The PT878GC returns to the Log Manager, which displays the logs with a status of “Pending” or “Running.”

## **Ending All Logs**

To end all currently pending or running logs, open the Log menu, scroll to the End All Logs option, and press [ENTER]. The PT878GC returns to the Log Manager, which displays the running logs with a status of “Finished.”

## **View All Sites**

To check on all logs, open the Log menu, scroll to the View All Sites option, and press [ENTER]. Logs are associated with the site in use at the time the log is created. Thus, when another site is in use, the PT878GC automatically starts different logs. By default, the Log Manager only displays the logs created with the current site. View All Sites allows the Manager to list logs for all sites.

## The View Menu

Through the View menu, you can view the data of individual logs in graphical or spreadsheet formats. To open the View menu from the Log Manager, press [MENU]. Scroll to the View menu, and press [ENTER]. The screen appears similar to Figure 8-10 below.

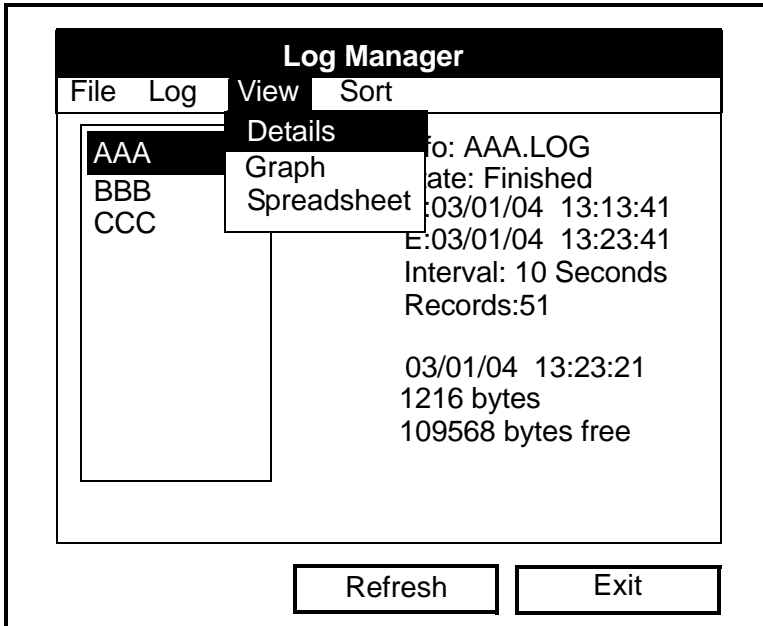
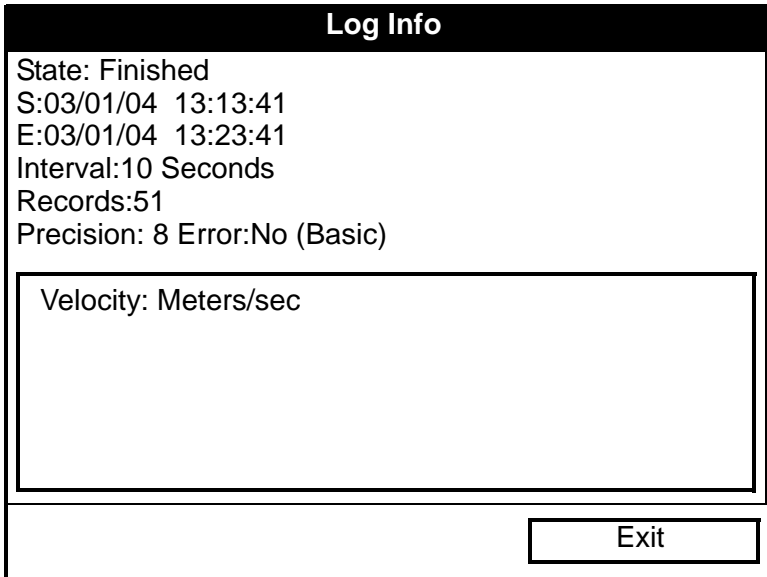

Figure 8-10: The View Menu

## Displaying Log Details

To view details of a given log, be sure the log is highlighted in the left window of the Log Manager. Then scroll to the View menu and press [ENTER]. Scroll to the Details option and press [ENTER]. The screen now appears similar to Figure 8-11 below.



**Figure 8-11: The Log Details Display Window,  
with List of Measurements in the Log**

Press [F3] (OK) to return to the Log Manager.

## Displaying Log Data in Graphical Form

To view a log in graphical form, be sure the log is highlighted in the left window of the Log Manager.

1. Scroll to the View menu and press [ENTER].
2. Scroll to the Graph option and press [ENTER].
3. The “Select Measurement” window appears, with the logged measurements. Be sure you have highlighted the desired measurement, and press [F3] (View).

The screen now appears similar to Figure 8-12 below.

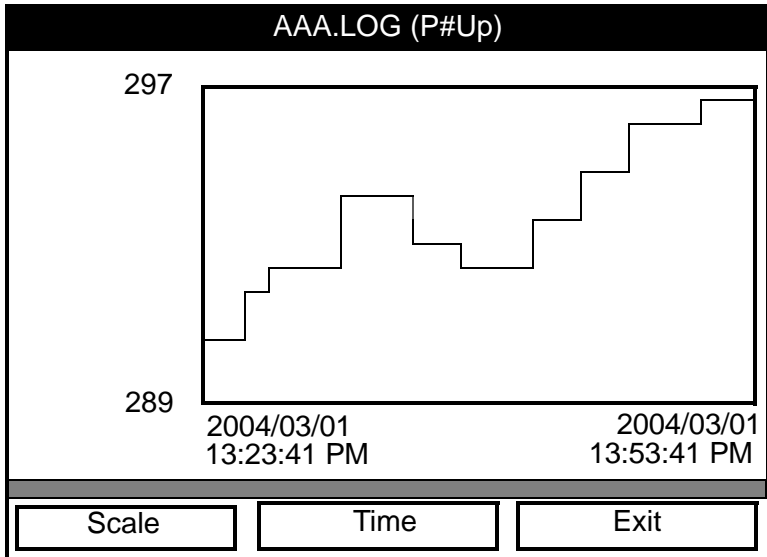

Figure 8-12: The Log Graph Display Window

**Note:** *If a log contains more than one measurement, you must select which measurement to plot from the list displayed.*

- If you wish to alter the graph scale, press [F1] (Scale). The window appears similar to Figure 8-13 on the next page.
- If you wish to alter the time scale, press [F2] (Time). The window appears similar to Figure 8-14 on page 8-21.
- To leave the window, press [F3] (Exit).

## Displaying Log Data in Graphical Form (cont.)

The screenshot shows a window titled "Y-Axis". Under the heading "Limits", there are three radio button options: "Max" (which is selected), "Range", and "Set". Below these are two text input fields: "Minimum" with the value "0.1234" and "Maximum" with the value "0.5678". At the bottom of the window, there is a horizontal axis with tick marks. Below the axis, the start time is "2004/03/01 13:23:41 PM" and the end time is "2004/03/01 13:53:41 PM". At the very bottom, there are two buttons: "Cancel" and "OK".

Figure 8-13: The Y-Axis Window

The Y-Axis window allows you to specify whether the Y axis on the graph extends to the maximum value (Max), over the entire range (Range) or between certain specified values (Set).

1. Use the [◀] and [▶] keys to scroll to the desired limit type. Press [ENTER] to confirm the entry.

If you select Max or Range for limits, you have finished entering data in this form. But if you select Set, the PT878GC asks for minimum and maximum limits.

2. Press the [▼] key to reach the Minimum text box.
  - a. Press [ENTER] to open the text box.
  - b. Use the numeric keys to enter the desired value.
  - c. Press [ENTER] to confirm the entry.
3. Repeat step 2 to enter the Maximum value.
4. When you have finished, press [F2] (Cancel) to cancel the entries, or [F3] (OK) to confirm the entries and change the graph.

## Displaying Log Data in Graphical Form (cont.)

If you wish to alter the time scale, press [F2] (Time). The Enter Time window appears similar to Figure 8-14 below.

AAA.LOG (P#Up)	
Enter Time	
Start Date	Start Time
<input type="text" value="2004/03/01"/>	<input type="text" value="13:23:41 PM"/>
End Date	End Time
<input type="text" value="2004/03/01"/>	<input type="text" value="13:53:41 PM"/>

**Figure 8-14: The Enter Time Window**

1. Use the arrow keys to scroll to the desired text box. Press [ENTER] to open the box.
2. Two alternatives are available to change a highlighted date or time:
  - Use the numeric keys to enter the desired number.
  - Use the [▼] or [▲] arrow keys to scroll, in 1-digit increments, to the desired number. (For example, if the text box displays 09, pressing the [▼] key twice changes the number to 07.) You can scroll from 01 to 12 for the month, from 01 to 31 for the day (depending on the number you have selected for the month), and from 0 to 59 for minutes and seconds.

In either case, press [ENTER] to confirm the entry.

3. Repeat step 2 for any other entries you wish to change.
4. When you have finished, press [F3] (OK) to confirm the entries and close the window.

## Displaying Log Data in Spreadsheet Form

To view a log in spreadsheet form, be sure the log is highlighted in the left window of the Log Manager. Then scroll to the View menu and press [ENTER]. Scroll to the Spreadsheet option and press [ENTER]. The screen now appears similar to Figure 8-15 below.

AAA.LOG	
Time	Diagnostics
03/20/2004 14:24:46	P# Up
14:24:56	290
14:25:06	291
14:25:17	293
14:25:27	295
14:25:37	294
14:25:47	293

Time	Refresh	Exit
------	---------	------

**Figure 8-15: The Log Spreadsheet Window**

Use the [◀] and [▶] keys to scroll to other columns, or the [▼] or [▲] keys to scroll backward or forward in time.

- To alter the times displayed, press [F1] (Time). The Enter Time window (shown on the previous page) opens. Follow the instructions on the previous page to change the date or time.
- To refresh the display, press [F2] (Refresh). The display shows the most current data.
- Press [F3] (Exit) to return to the Log Manager.



## The Sort Menu

The Sort Menu within the Log Manager allows you to arrange your log list either alphabetically (By Name) or chronologically (By Date).

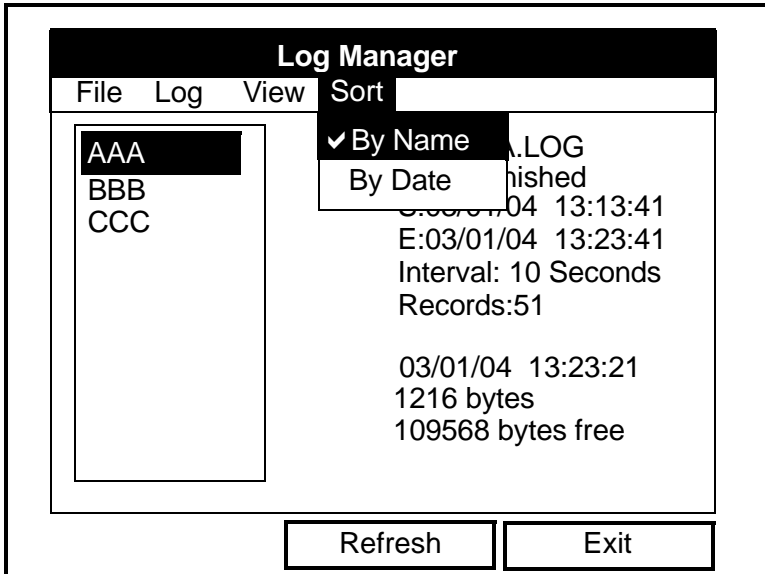

Figure 8-16: Sort Menu in the Log Manager

### Listing Logs by Name

If you want to list your logs alphabetically by log name within the Log Manager, press [MENU] to open the File Menu. Then scroll from the File Menu to the Sort Menu, shown in Figure 8-16 above. Press [ENTER]. The Log Manager screen refreshes, with the sites listed in alphabetical order.

### Listing Logs in Chronological Order

If you prefer to list your logs chronologically by time of creation within the Log Manager, press [MENU] to open the File Menu. Then scroll from the File Menu to the Sort Menu, and scroll to the By Date option. Press [ENTER]. The Log Manager screen refreshes, with the sites listed in chronological order, from the most recent to the earliest.

# Chapter 9

## Servicing the PT878GC

---

For user convenience, the PT878GC offers a Service Menu. This menu enables users to perform a variety of functions that they might occasionally require:

- print out reports
- calibrate the PT878GC
- run diagnostics
- set up signal parameters and peak detection
- define error limits
- test the meter screen and keys
- determine setup errors with impulse response
- check test points
- return to factory default parameters
- load updated versions of the meter program into the PT878GC.

## Entering the Service Menu

To enter the Service Menu, press the [MENU] key at the lower right of the PT878GC keypad. The Main Menu replaces the Status Bar at the top of the screen. Press the [▶] arrow key four times to scroll from the Site Menu to the Service Menu. At the Service Menu, press [ENTER]. The screen appears similar to Figure 9-1 below. When programming, refer to Figure A-10 on page A-10 of Appendix A, *Menu Maps*.

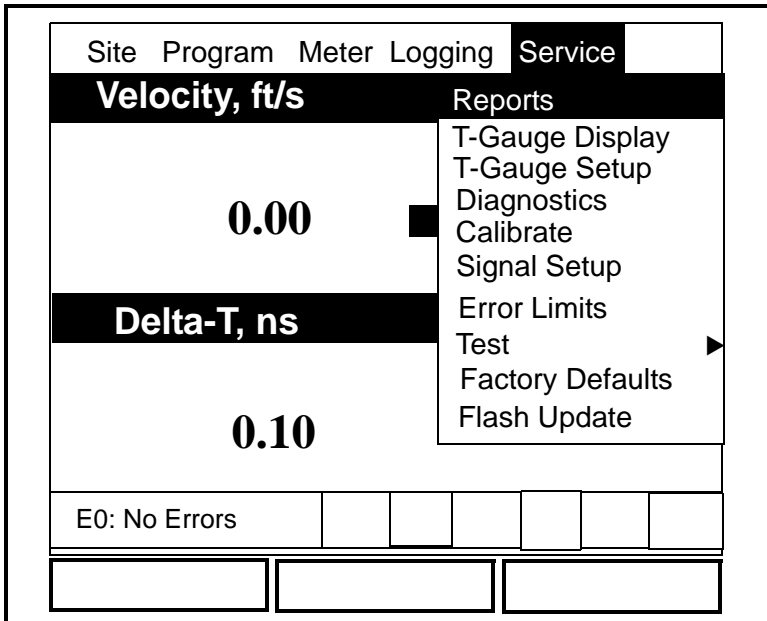

Figure 9-1: The Service Menu

To scroll to a particular option, press the [▼] or [▲] arrow keys until you reach the option. Then press [ENTER] to open the option window.

When entering parameters in an option, press:

- The [▼] key to step through the available parameters.
- The [▲] key to scroll back to a previously entered parameter.
- The [F2] key (Cancel) or the [ESC] key to exit an option at any time and return to Operate Mode without changing the parameters.

---

## Printing Reports

When used with an IR-compatible printer, the PT878GC can print out a variety of data (current site, logs, drive contents, and user functions, tables, and settings) in the Reports option. To enter the Reports option, scroll to the Reports entry on the Service Menu and press [ENTER]. The screen appears similar to Figure 9-2 below.

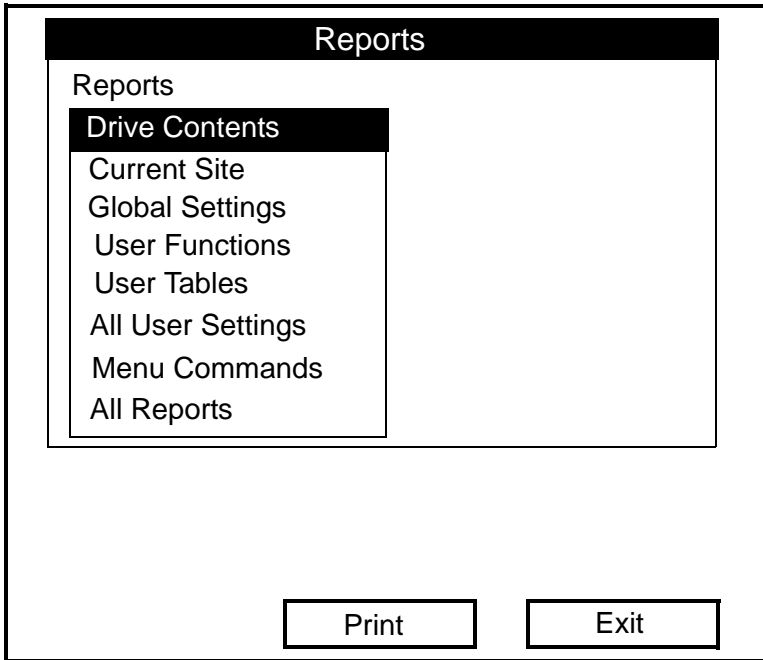

Figure 9-2: The Reports Window

Press [ENTER] to open the drop-down list of available reports, as shown in Figure 9-2 above. Press the [▼] or [▲] arrow keys to scroll to the desired reports, and press [ENTER]. Then press [F2] (Print) to print out the desired reports, or press [F3] (Exit) to leave the option and return to Operate Mode. Figure 9-3 on the next page shows a typical printout of a drive report.

## Printing Reports (cont.)

```

-----
Drive Report
-----
Bytes Free: 797696
filename      size      Date:      Time:
-----
Site Files
DEFAULT.SIT  6322      01/09/17   18:19:03
MINILOOP.SIT 7016      01/09/19   17:50:20
WETTED.SIT   7003      01/09/25   14:02:19
STC_2MHZ.SIT 6973      01/09/20   13:17:19
6INEX.SIT    6372      01/09/20   16:11:08
6INST.SIT    6369      01/09/20   16:12:01
2MHZWET.SIT  6982      01/09/26   16:49:10
500KCWET.SIT 6255      01/09/26   16:50:04
3VIEW.SIT    6226      01/09/26   16:49:03
1MHZWET.SIT  6181      01/09/26   16:49:18
4MHZCLMP.SIT 6209      01/09/26   16:49:26
Log Files
LOG01.LOG    161792    01/09/26   19:12:19
Meter Configuration Files
SYSLOG.MET   5506      01/09/26   17:10:26
GLOBAL.MET   1500      01/09/25   18:12:10
-- 1 --

```

Figure 9-3: Printout of a Typical Drive Report

---

## Setting up the Thickness Gauge

For greatest accuracy in flow applications, the PT878GC can measure pipe wall thickness using an optional thickness gauge transducer, instead of relying on the nominal pipe wall thickness. In Thickness Gauge mode, the PT878GC does not measure flow, but it can determine the thickness of most standard metal and plastic pipe materials over a range from 0.05 to 3 in. (1.3 to 76.2 mm). Figure 9-4 below illustrates use of the optional thickness gauge.



**Figure 9-4: PT878GC Thickness Gauge in Operation**

The PT878GC offers two basic thickness gauge functions: using the gauge to measure thickness after entering the pipe material, and calibrating the gauge. For the highest possible accuracy, you can also calibrate the velocity of sound in the pipe material.

Using the thickness gauge involves three steps:

1. Entering the material and sound speed (in the Material window on page 9-7),
2. Measuring the pipe wall thickness (in the Display window on page 9-9), and
3. If the measurement seems unreasonable, examining the acoustic signal to diagnose the problem (in the Graph window on page 9-10).

## Setting up the Thickness Gauge (cont.)

Calibrating the thickness gauge involves up to two additional steps:

4. Calibrating the thickness gauge itself (in the Zero window on page 9-12), and
5. Calibrating the velocity of sound in the pipe material (in the Velocity window on page 9-14), if possible and if the pipe material is not the material entered in the Zero window. This step requires a trustworthy reference, either a section of pipe (such as a flange or open pipe section) that can be measured with calipers or another measurement device, or a thickness calibration block of the same material.

## Measuring Pipe Wall Thickness

### Entering the Material and Sound Speed

**IMPORTANT:** *GE Infrastructure Sensing recommends calibrating the thickness gauge periodically (as discussed on page 9-12) before measuring thickness.*

To enter the Thickness Gauge Display option, scroll to the T-Gauge Display entry on the Service Menu and press [ENTER]. The screen appears similar to Figure 9-5 below.

The screenshot shows a window titled "Thickness Gauge Measure". At the top, there is a menu bar with five options: "Display", "Graph", "Velocity", "Zero", and "Material". The "Material" option is currently selected and highlighted. Below the menu bar, the main content area contains two prompts: "Material" followed by a dropdown menu box containing the text "Other", and "Sound Speed" followed by a numeric input box containing "0" and the unit "m/sec". At the bottom of the window, there are two buttons: "Cancel" on the left and "OK" on the right.

Figure 9-5: The Material Window

1. From the Thickness Gauge Display option, press the [▶] arrow key four times to enter the Material window.
2. The first prompt asks you to select the material list for the pipe wall you wish to measure from a drop-down list.
  - a. Press [ENTER] to open the list.
  - b. Use the [▼] or [▲] arrow keys to scroll to the desired material.
  - c. Press [ENTER] to confirm your selection.



## Entering the Material and Sound Speed (cont.)

If you have selected a preprogrammed material, you have completed entering data in this window. Pressing the [▼] key returns the program to the Material tab. But if you selected “Other,” you can also enter a specific sound speed.

3. To enter the sound speed:
  - a. Press [ENTER] to open the text box.
  - b. Use the numeric keys to enter the known sound speed in the pipe material (from the brochure *Sound Speeds and Pipe Size Data*, 914-004).
  - c. Press [ENTER] to confirm your entry.

To leave the Material window:

- Press the [◀] or [▶] arrow key to move to another tab to take readings or perform a velocity calibration.
- Press [F2] (Cancel) to return to Operate Mode without confirming the sound speed value.
- Press [F3] (OK) to confirm the new value. The PT878GC returns to Operate Mode.

## Measuring Thickness in Numeric Format

To measure the actual thickness of a pipe, apply couplant to the calibrated thickness gauge transducer and hold the transducer steady against the pipe. Then press the [◀] or [▶] arrow key until you reach the Display tab and press [ENTER]. The T-Gauge Display option shows the thickness measurement in numeric format (displayed in Figure 9-6 below).

**Note:** Refer to Appendix C, Ultrasonic Thickness Gauge Theory of Operation, page C-3, to learn how to position and align the transducer.

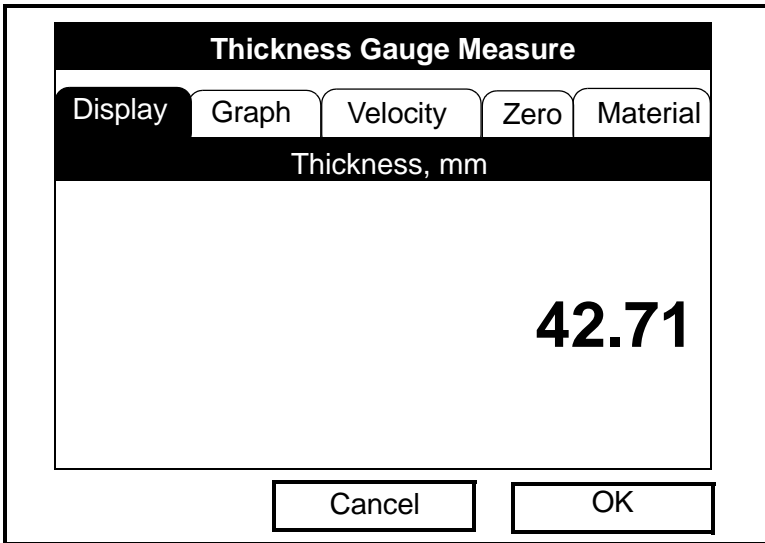

Figure 9-6: The Thickness Gauge Display Window

Be sure the “Noise” or “Los” (loss of signal) boxes do not appear. Press [F2] (Cancel) or [F3] (OK) to return to Operate Mode, or press the [▶] arrow key to move to another window in the option.

## Displaying the Receive Signal in Graphical Format

Used chiefly for diagnostic purposes, the Graph option helps to determine why the thickness gauge is not working if you suspect a problem. The graph shows an image of the acoustic signal. If the display does not show a signal image similar to Figure 9-7 below, you may have a problem with the transducer, couplant, or the programmed values. Also, some materials (such as Teflon<sup>®</sup> or fiberglass) do not support acoustic signals.

To open the Graph window and display the receive signal graphically, press the [◀] or [▶] arrow key until you reach the Graph tab and press [ENTER]. The screen appears similar to Figure 9-7 below.

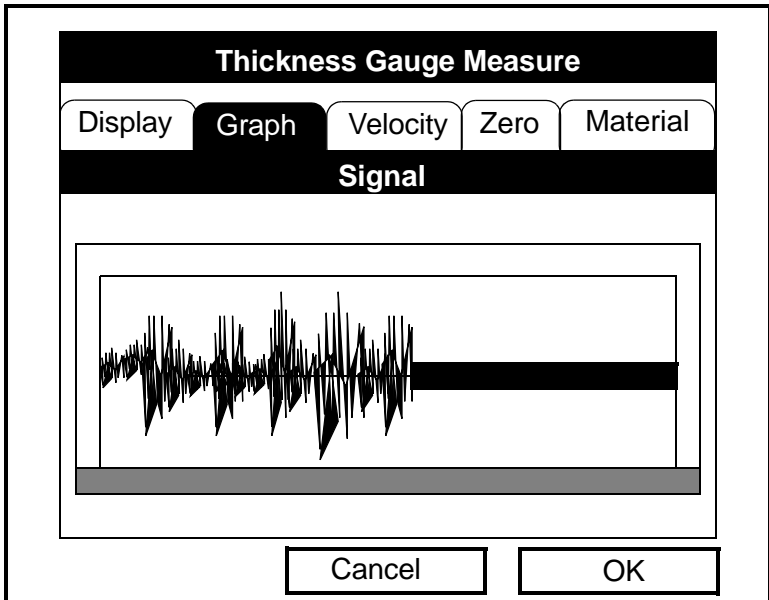

Figure 9-7: The Thickness Gauge Graph Window

Press [F2] (Cancel) or [F3] (OK) to return to Operate Mode, or press the [▶] arrow key to move to another window in the option. However, if you wish to adjust the graph, press the [▼] key. The screen now appears similar to Figure 9-8 on the next page.

## Displaying the Receive Signal in Graphical Format (cont.)

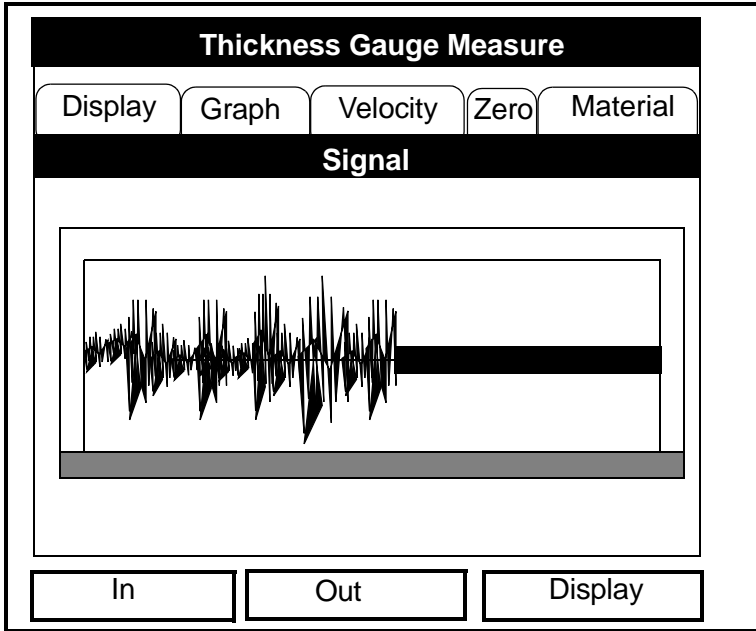

Figure 9-8: The Graph Window in Zoom Format

- Press [F1] (In) to zoom in to magnify screen details.
- Press [F2] (Out) to zoom out fully.
- Press [F3] to toggle between the left and right cursors.
- Press [◀] and [▶] to move the selected cursor left and right.
- Press [▼] to select the graph.
- Press [▲] to return to tab navigation.
- Press [ESC] to return to Operate Mode without saving the calibration changes.

## Calibrating the Thickness Gauge Transducer

To zero the transducer offsets, go to the Zero tab. Press the [◀] or [▶] arrow key until you reach the Zero tab and press [ENTER]. The screen appears similar to Figure 9-9 below.

**Thickness Gauge Measure**

Display Graph Velocity **Zero** Material

Single     Dual Calibration

Block 1 Length  mm

---

Transducer Delay,  $\mu$ s

Calculated     Current

**Figure 9-9: The Zero Window**

1. Press the [▼] arrow key to enter the window.
2. The first prompt asks you to choose between single and dual-point calibration. Use the [◀] and [▶] arrow keys to move to the appropriate radio button and press [ENTER].

**Note:** *GE Infrastructure Sensing recommends dual calibration. Dual-point calibration is more reliable, but it requires two known thicknesses of the calibration material. Use single-point calibration only if you know the sound speed in the calibration block material to a high degree of accuracy. See Appendix C for more information.*

3. The next prompt asks you to enter the length of Block 1. (If you are using a GE Infrastructure Sensing-supplied test block, the length is printed on the block.) Press [ENTER] to open the text box.

## Calibrating the Thickness Gauge Transducer (cont.)

- a. Press [ENTER] to open the text box.
  - b. Use the numeric keys to enter the length.
  - c. Press [ENTER] to confirm the entry.
4. Press [ENTER] (Calibrate button) to prepare for calibration. Then apply couplant B to the block surface, and hold the transducer against the block.
  5. When you have the transducer firmly pressed against the block, press [ENTER] (Ready button) again to perform the calibration.
  6. Hold the transducer steady until the Set button appears. Press [ENTER] to store the calibration.

**IMPORTANT:** *Be sure to hold the transducer steady until the GE Infrastructure Sensing wait cursor disappears.*

7. If you have chosen dual calibration, repeat Steps 3 through 6 above for Block 2.
8. The PT878GC asks for confirmation of the calculated and current values.
  - Press the [▲] arrow key to move to the Retry box and press [ENTER] to recalculate the value, or
  - Press [ENTER] on “Set” to commit the calculated value.

Once you have completed calibration, the transducer should remain calibrated until the meter memory is cleared or a dramatic shift in ambient conditions occurs.

To leave the Zero window:

- Press the [◀] or [▶] arrow key to move to another tab to take readings or perform a velocity calibration.
- Press [F2] (Cancel) to return to Operate Mode without confirming the sound speed value.
- Press [F3] (OK) to confirm the new value. The PT878GC returns to Operate Mode.

## Calculating Velocity (Pipe Material Sound Speed)

The nominal sound speed for your pipe material will give thickness measurements of reasonable accuracy. However, for greater accuracy, calibrate pipe material sound velocity.

**IMPORTANT:** *This step is necessary only if the actual pipe material sound speed differs from the sound speed of the material used in the calibration block. It is possible only if you have a sample of pipe material with the thickness known to a high level of precision.*

To open the Velocity window, press the [◀] or [▶] arrow key until you reach the Velocity tab and press [ENTER]. The screen appears similar to Figure 9-10 below.

The screenshot shows a window titled "Thickness Gauge Measure" with a black header. Below the header are five tabs: "Display", "Graph", "Velocity", "Zero", and "Material". The "Velocity" tab is selected and highlighted in black. The main area of the window contains the following elements:

- "Block Length" followed by a text input field containing the number "0".
- A horizontal line separating the top section from the bottom section.
- The text "Determine the Sound Speed" centered below the line.
- "Calculated" followed by a text input field.
- "Current" followed by a text input field.
- At the bottom of the window, there are two buttons: "Cancel" and "OK".

Figure 9-10: The Sound Speed Window

1. Scroll to the Velocity tab as shown in Figure 9-10 above. Press [ENTER].

## Calculating Velocity (Pipe Material Sound Speed) (cont.)

2. To enter the block length (here, the thickness of the sample as measured with a caliper or calibrated sample), press the [▼] arrow key and then press [ENTER] to open the Block Length text box. Use the numeric keys to enter the measured block length. Press [ENTER] to confirm the entry.
3. Prepare the sample for calibration by applying couplant B to its surface, and press [ENTER]. The screen now appears similar to Figure 9-11 below.
4. Hold the transducer steady against the sample, and wait for the Set button to appear.
5. To calibrate the gauge, press the [▼] arrow key to move to the Set button.
6. Press [ENTER] (Set button) to start the calibration sequence.

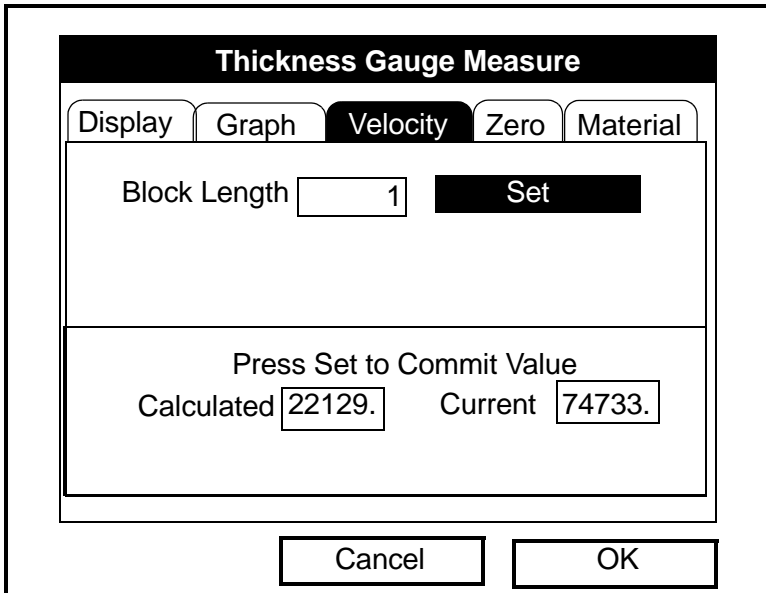

Figure 9-11: The Velocity Window, Displaying the Calculated and Current Values



## Calculating Velocity (Pipe Material Sound Speed) (cont.)

7. The “Calculated” box shows the thickness value measured. The PT878GC asks for confirmation of the calculated and current values. Press [ENTER] to commit (accept) the calculated value (in which case it becomes the current value), and to recalculate the value (which becomes the new “Calculated” value).

**Note:** *If you commit the calculated value, the settings in the Material window also change from the previous material to “Other” with the new sound speed.*

To leave the Velocity window:

- Press the [◀] or [▶] arrow key to move to another tab.
- Press [F2] (Cancel) to return to Operate Mode without confirming the sound speed value.
- Press [F3] (OK) to confirm the new value and return to Operate Mode.

---

## Programming the Thickness Gauge

While the T-Gauge Display option allows you to program the appropriate material and sound speed, the Thickness Gauge Setup option enables you to view or change five parameters:

- Low Signal Threshold
- Transducer Delay
- Signal Inversion
- Noise Threshold
- Detection Threshold

**IMPORTANT:** *The thickness gauge programming settings are entered at the factory. You should not change them unless instructed by GE Infrastructure Sensing.*

The Programming window appears similar to Figure 9-12 below.

The screenshot shows a window titled "Thickness Gauge Setup" with a sub-tab labeled "Programming". Inside the window, there are five settings, each with a text label, a numeric input field, and a unit:

- Low Signal Thresh: 0 %
- Transducer Delay: 0 μs
- Signal Inversion: Two radio buttons, "On" (unselected) and "Off" (selected).
- Noise Threshold: 0 %
- Detection Threshold: 0 %

At the bottom of the window are two buttons: "Cancel" and "OK".

Figure 9-12: The Thickness Gauge Programming Window

## Programming the Thickness Gauge (cont.)

1. Press the [▼] arrow key to enter the window.
2. The first prompt asks for the low signal threshold. If the signal strength falls below this value, a “Low Signal” message appears on the screen. To change this value:
  - a. Press [ENTER] to open the text box.
  - b. Use the numeric keys to enter the provided value.
  - c. Press [ENTER] to confirm your entry.
3. The next value, transducer delay, represents the time the ultrasonic signal takes to travel from the meter to the pipe material surface. To change this value:
  - a. Press [ENTER] to open the text box.
  - b. Use the numeric keys to enter the desired value.
  - c. Press [ENTER] to confirm your entry.
4. The signal inversion prompt enables you to invert the thickness transducer signal. Signal inversion may be necessary if your thickness readings show unusual jitter, or for certain unusual combinations of pipe and fluid or pipe and lining. Consult the factory before measuring the thickness of lined pipes.

**Note:** *When measuring the thickness of certain pipe materials, you might need to drain the pipe before measuring the pipe wall, because certain pipe/liquid combinations muffle the ultrasonic echo.*

Signal inversion should be on, unless you have received other instructions. To change its status, use the [◀] and [▶] arrow keys to move to the appropriate radio button and press [ENTER].

5. To enter the noise threshold:
  - a. Press [ENTER] to open the text box.
  - b. Use the numeric keys to enter the recommended value.
  - c. Press [ENTER] to confirm your entry.

## Programming the Thickness Gauge (cont.)

6. The final value, the detection threshold, represents the percent of peak the PT878GC uses to make measurements. It will consider anything above the entered percentage as part of the signal. To change this value:
  - a. Press [ENTER] to open the text box.
  - b. Use the numeric keys to enter the recommended value.
  - c. Press [ENTER] to confirm your entry.

You have finished entering values for the Programming window. To leave this window:

- Press the [◀] arrow key to move to the Materials tab.
- Press [F2] (Cancel) to return to Operate Mode without confirming the changes. The PT878GC returns to Operate Mode.
- Press [F3] (OK) to confirm the new data and return to Operate Mode. The PT878GC returns to Operate Mode.

## Displaying Diagnostic Parameters

The Diagnostics option enables you to view current diagnostic parameters without having to open a display window in Operate Mode. To enter the option, scroll to the Diagnostics entry on the Service Menu and press [ENTER]. The screen appears similar to Figure 9-13 below.

Diagnostic Tests		
Meter Error 0x0000	Up	Down
T	430.67	430.67
P#	493	493
Sig Quality	5257	4952
Amplitude	30.4	28.8
Gain	-6.5	-7.0
Count	919	897
Signal	65.9	65.9
Soundspeed m/s	1503.9	
Reynolds #	500	
kRe	0.7704	
Delta T	0.69	
m/s	0.03	
<input type="button" value="Cancel"/> <input type="button" value="OK"/>		

Figure 9-13: The Diagnostics Window

Press [F2] (Cancel) or [F3] (OK) to close the window and return to Operate Mode.

**Note:** For an explanation of diagnostic parameters, refer to Chapter 10, Diagnostics and Troubleshooting.

## Calibrating the Analog Output and Inputs

The Calibration option allows you to calibrate the analog output and inputs. To enter the option, scroll to the Calibrate entry on the Service Menu and press [ENTER]. The screen appears similar to Figure 9-14 below.

The screenshot shows a terminal window titled "Calibrate/Test I/O". At the top, there are two tabs: "Analog Output" (which is selected) and "Analog Input". Below the tabs, the "Setpoint" section has two radio button options: "4 mA" (unselected) and "20 mA" (selected). Underneath, there are two columns of input fields. The left column is for "Actual 4 mA" and contains a text box with the value "4". The right column is for "Actual 20 mA" and contains a text box with the value "20". Below these text boxes are two buttons: "Calibrate" under the 4 mA column and "Reset" under the 20 mA column. At the bottom of the window are two large buttons: "Cancel" on the left and "OK" on the right.

Figure 9-14: The Outputs Window in the Calibration Option

### Calibrating the Analog Output

The calibration procedure consists of calibrating the analog output zero point (0 or 4 mA) and then calibrating the full scale span point (20 mA). You enter, first the setpoint, and then the actual value measured with a digital ammeter or voltmeter. The analog outputs have a resolution of  $\pm 5.0 \mu\text{A}$ . Press the [▼] arrow key to enter the Analog Output window.

## Calibrating the Analog Output (cont.)

1. Connect a digital multimeter or ammeter to the analog output.
2. The next prompt asks for the setpoint (4 or 20 mA). Use the [◀] and [▶] arrow keys to move to the appropriate radio button and press [ENTER].
3. The next prompt asks you to enter the actual value shown on the multimeter or ammeter.
  - a. Press [ENTER] to open the text box.
  - b. Use the numeric keys to enter the measured value.
  - c. Press [ENTER] to confirm your entry.
4. Repeat steps 2 and 3 for the other setpoint.
5. Press the [▼] arrow key to move to the Calibrate box, and then press [ENTER] to calibrate the output.

If you are unsatisfied with the calibration, you can reset the inputs to factory defaults. Press the [▶] arrow key to move to the Reset box, and then press [ENTER] to undo the calibration.

You have completed calibrating the outputs. To leave the Output window,

- Press the [▲] key to return to the Output tab, and the [▶] arrow key to move to the Input tab.
- Press [F2] (Cancel) to return to Operate Mode without confirming the changes.
- Press [F3] (OK) to confirm the new data. The PT878GC returns to Operate Mode.

## Calibrating Inputs

To open the Inputs window, press the [▶] arrow key and press [ENTER]. The screen appears similar to Figure 9-15 below.

**Note:** *Calibrating the analog inputs requires use of a current source.*

The screenshot shows a window titled "Calibrate/Test I/O". It has two tabs: "Analog Output" and "Analog Input", with "Analog Input" selected. The window contains the following elements:

- Input#**: A drop-down menu showing "A".
- Low**: A text box containing "4" followed by "mA". To its right is a "Read" button.
- High**: A text box containing "20" followed by "mA". To its right is a "Read" button.
- At the bottom of the main area are two buttons: "Calibrate" and "Reset".
- At the bottom of the entire window are two buttons: "Cancel" and "OK".

Figure 9-15: The Inputs Window in the Calibrate Option

1. Press the [▼] arrow key to enter the window.
2. The first prompt asks you to select the input.
  - a. Press [ENTER] to open the drop-down list.
  - b. Use the [▼] or [▲] arrow keys to scroll to the desired output (A or B).
  - c. Press [ENTER] to confirm your selection.
3. The next prompt asks for the value to which you want to set the low input (0 or 4 mA).
  - a. Press [ENTER] to open the text box.
  - b. Use the numeric keys to enter the desired value.
  - c. Press [ENTER] to confirm your entry.



## Calibrating Inputs (cont.)

4. Connect the current source to the input and set it to deliver the value entered in the previous step.
5. Press the [▶] arrow key to move to the Read box, and then press [ENTER] to read the low input.
6. The next prompt asks for the value to which you want to set the high input (20 mA).
  - a. Press [ENTER] to open the text box.
  - b. Use the numeric keys to enter the recommended value.
  - c. Press [ENTER] to confirm your entry.
7. Connect the current source to the input and set it to deliver the value entered in the previous step.
8. Press the [▶] arrow key to move to the Read box, and then press [ENTER] to read the high input.
9. Press the [▼] key to move to the Calibrate box, and press [ENTER] to calibrate the inputs.
10. At this point, you have two options:
  - a. If you are unsatisfied with the calibration, you can reset the inputs to factory defaults. Press the [▶] arrow key to move to the Reset box, and then press [ENTER] to undo the calibration.
  - b. If you are satisfied with the calibration, press the [▼] key to return to the Input# prompt, and repeat steps 2 through 8 for the other input.

You have completed calibrating the inputs. To leave the Inputs window,

- Press the [▲] key to return to the Inputs tab, and the [◀] arrow key to move to the Outputs tab.
- Press [F2] (Cancel) to return to Operate Mode without confirming the changes.
- Press [F3] (OK) to confirm the new data. The PT878GC returns to Operate Mode.

---

## Setting up Signal Parameters

The Signal Setup option enables you to set parameters that affect the transducer signal:

- Delta-T Offset
- Transmit Sample Size
- Zero Cutoff
- Velocity Averaging
- Errors Allowed
- Peak Detection Method
- Peak Thresholds
- Pulse and Code

To enter the option, scroll to the Signal Setup entry on the Service Menu and press [ENTER]. The screen appears similar to Figure 9-16 below.

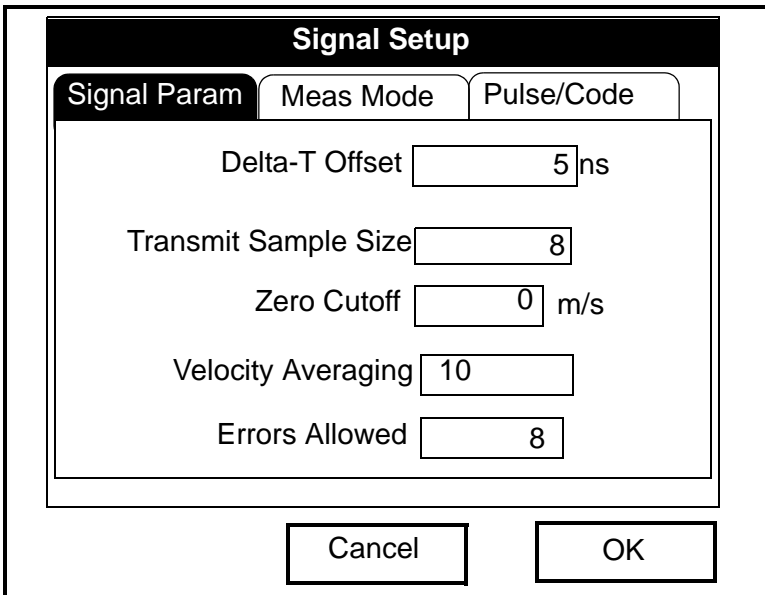

The image shows a screenshot of a 'Signal Setup' window. At the top, the title 'Signal Setup' is displayed in a black bar. Below the title, there are three tabs: 'Signal Param' (which is selected and highlighted in black), 'Meas Mode', and 'Pulse/Code'. The main area of the window contains several parameters, each with a text label and a numeric input field:

- Delta-T Offset: 5 ns
- Transmit Sample Size: 8
- Zero Cutoff: 0 m/s
- Velocity Averaging: 10
- Errors Allowed: 8

At the bottom of the window, there are two buttons: 'Cancel' and 'OK'.

Figure 9-16: The Signal Parameter Window

## Setting up Signal Parameters (cont.)

1. Press the [▼] arrow key to enter the window.
2. The first prompt asks for the Delta-T offset. Delta-T is the difference between the upstream and downstream transit times of the transducers. The Delta-T offset should normally be set to zero.

**Note:** *Consult GE Infrastructure Sensing before performing this step.*

- a. Press [ENTER] to open the text box.
  - b. Use the numeric keys to enter the recommended value.
  - c. Press [ENTER] to confirm your entry.
3. The next prompt, the transmitter sample size, is the number of pulses each transmitter (upstream and downstream) emits. It is set to 8 by default.

**Note:** *Consult GE Infrastructure Sensing before performing this step.*

- a. Press [ENTER] to open the drop-down list.
  - b. Use the [▼] or [▲] arrow keys to scroll to the recommended number.
  - c. Press [ENTER] to confirm your selection.
4. The next prompt asks for the zero cutoff. Near “zero” flow, the PT878GC may have fluctuating readings due to small offsets (caused by factors such as thermal drift in the fluid). The zero cutoff causes velocity measurements less than the cutoff to be reported as zero. To set the cutoff:
    - a. Press [ENTER] to open the text box.
    - b. Use the numeric keys to enter the desired value.
    - c. Press [ENTER] to confirm your entry.

---

## Setting up Signal Parameters (cont.)

5. The next prompt asks for velocity averaging, the number of velocity measurements to average together to smooth out noise in the system.
  - a. Press [ENTER] to open the drop-down list.
  - b. Use the [▼] or [▲] arrow keys to scroll to the desired number.
  - c. Press [ENTER] to confirm your selection.
6. The final prompt, errors allowed, specifies the number of errors the meter can record before displaying an error message.
  - a. Press [ENTER] to open the text box.
  - b. Use the numeric keys to enter the desired value.
  - c. Press [ENTER] to confirm your entry.

You have finished entering data in the Signal Parameter window. To leave this window,

- Press the [▼] key to return to the Signal Parameter tab, and the [▶] arrow key to move to the Measurement Mode tab.
- Press [F2] (Cancel) to return to Operate Mode without confirming the changes.
- Press [F3] (OK) to confirm the new data and return to Operate Mode.

## Setting up the Measurement Mode

The PT878GC can take measurements in four different ways:

**Skand** is a low resolution technique for locating the acoustic signal and for high velocity measurements. It is more robust in a noisy environment than the Measure technique.

**Measure** is a more precise technique best used for low velocity measurements. You can choose from *Skand/Measure Count* (the default technique) or *Skand/Measure Integrate* (the traditional Skand/Measure mode). A variation, the *Skand/Correlation* mode, is used primarily for liquid flow measurement.

**Note:** *Do not change the measurement mode or values unless recommended by GE Infrastructure Sensing.*

From the Signal Parameter tab, press the [▶] arrow key to move to the Meas Mode tab. The window appears similar to Figure 9-17 below.

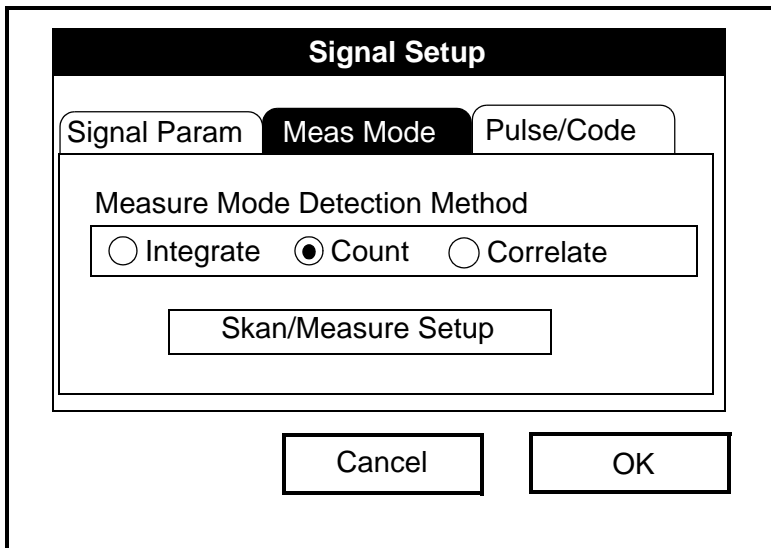

**Figure 9-17: The Measurement Mode Window in the Signal Setup Option**

## Setting up Measurement Mode (cont.)

The first prompt asks for the measurement mode detection method. Use the [◀] and [▶] arrow keys to move to the appropriate radio button and press [ENTER].

You must now enter the setup data covered on page 4-23, if you have not already done so. Pressing the [▼] key takes you to “Skan/Measure Setup.” Press [ENTER] to open the Skan/Measure option and enter the parameters discussed on page 4-23.

You have completed entering data for the Measurement Mode. To leave this window,

- Press the [▲] key to return to the Measurement Mode tab, and the [◀] arrow key to move to the Signal Parameter tab or the [▶] arrow key to move to the Pulse/Code tab.
- Press [F2] (Cancel) to return to Operate Mode without confirming the changes.
- Press [F3] (OK) to confirm the new data and return to Operate Mode.

## Setting Up Pulse/Code Parameters

When you select the Skan detection method, you must also choose what type of signal to send to the transducers: either a coded signal at 1, 2, 4, 11 or Twin bits, or a specific number of pulses to be sent. From the Meas Mode tab, press the [▶] arrow key to move to the Pulse/Code tab. The window appears similar to Figure 9-18 below.

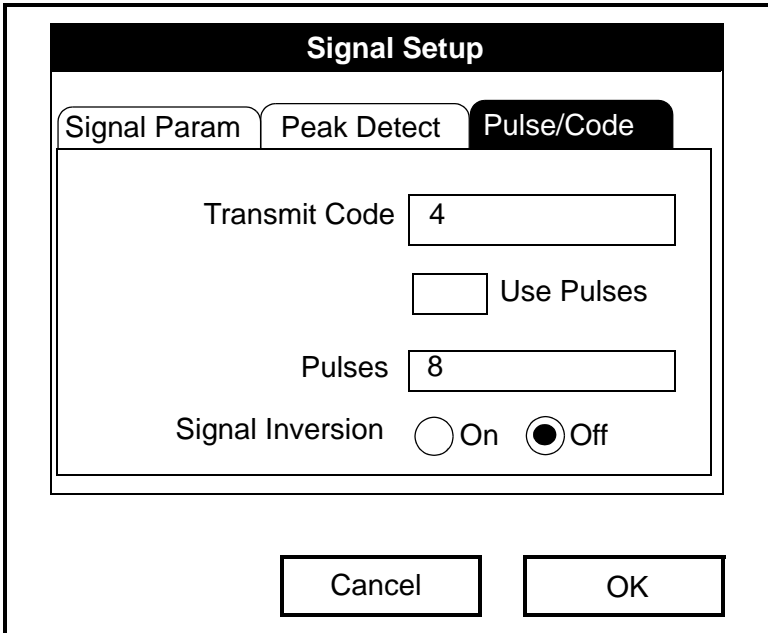

**Figure 9-18: The Pulse/Code Window in the Signal Setup Option**

1. The first prompt asks for the number of bits in the coded signal.
  - a. Press [ENTER] or [SEL] to open the drop-down list.
  - b. Use the [▼] or [▲] arrow keys to scroll to the recommended number.
  - c. Press [ENTER] to confirm your selection.

## Setting Up Pulse/Code Parameters (cont.)

2. The next prompt asks if you want to send a specific number of pulses. Press [ENTER] to select or deselect the pulse option.

**Note:** *If you do not select this option, pressing the [▼] key returns the meter to the Transmit Code prompt.*

3. The next prompt asks how many pulses (from 0 to 16) you wish to send.
  - a. Press [ENTER] to open the drop-down list.
  - b. Use the [▼] or [▲] arrow keys to scroll to the recommended number.
  - c. Press [ENTER] to confirm your selection.
4. The final prompt, signal inversion, enables you to invert the transducer signal. Signal inversion may be necessary if your readings show unusual jitter, or for certain unusual combinations of pipe and fluid or pipe and lining. Signal inversion should be off, unless you have received other instructions. To change its status, use the [◀] and [▶] arrow keys to move to the appropriate radio button and press [ENTER].

You have completed entering data in the Signal Setup option.

- Press [F2] (Cancel) to return to Operate Mode without confirming the changes.
- Press [F3] (OK) to confirm the new data and return to Operate Mode.



## Setting Error Limits

The Error Limits option enables you to set limits for an incoming signal. When the signal falls outside the programmed limits, an error indication appears. To enter this option, scroll to the Error Limits entry on the Service Menu and press [ENTER]. The screen appears similar to Figure 9-19 below.

The screenshot shows a menu titled "Signal Error Limits" with the following fields and values:

	Min	Max	
Signal	10	72	
Velocity	-22.56	22.56	m/s
Amplitude	14	34	
Sound Speed (±)	20		%
Acceleration	4.572		m/s

At the bottom of the screen are two buttons: "Cancel" and "OK".

**Figure 9-19: The Signal Error Limits Option**

1. The first prompt asks for the minimum and maximum limits for the transducer signal received by the PT878GC. The default values are 10 for the minimum and 72 for the maximum. The E1: LOW SIGNAL error message appears if the signal strength falls below the limit programmed here.

To enter the minimum signal:

- a. Press [ENTER] to open the text box.
- b. Use the numeric keys to enter the desired value.
- c. Press [ENTER] to confirm your entry.

---

## Setting Error Limits (cont.)

- d. Press the [▶] arrow key to move to the maximum signal box, and repeat steps a, b and c.
      - e. Press the [◀] arrow key to return to the minimum signal box, and the [▼] key to move to the next limit.
2. The next prompt calls for the low and high velocity limits. The E3: VELOCITY RANGE error message appears if the velocity falls outside these limits. Repeat the steps in Step 1 on the previous page to enter the desired limits.
3. The third prompt calls for the low and high limits for the amplitude discriminator. The discriminator measures the size of the transducer signal sent from the PT878GC. If the signal falls outside these limits, the E5: AMPLITUDE error message appears. Repeat the steps in Step 1 on the previous page to enter the desired limits.
4. The fourth prompt asks for the acceptable limits for the sound speed, based on conditions in your particular system. The E2: SOUND SPEED error message appears if the fluid sound speed exceeds that entered in the Pipe option of the Program menu by more than this percentage. The default value is 20% of the nominal soundspeed.
  - a. Press [ENTER] to open the text box.
  - b. Use the numeric keys to enter the desired percentage.
  - c. Press [ENTER] to confirm your entry.
5. The final prompt asks for the acceleration limit for detecting cycle skipping. The E6: CYCLE SKIP/ACCELERATION message appears if the velocity changes by more than this limit from one reading to the next.
  - a. Press [ENTER] to open the text box.
  - b. Use the numeric keys to enter the desired speed.
  - c. Press [ENTER] to confirm your entry.

## Setting Error Limits (cont.)

**Note:** *For the velocity and acceleration boxes, the F1 softkey toggles between English and metric measurements. Thus, the key will always display the opposite measurement from that which is currently active. Press [F1] to display the measurement in the alternate format.*

You have completed entering signal error limits.

- Press [F2] (Cancel) to return to Operate Mode without confirming the error limits, or
- Press [F3] (OK) to confirm the new limits and return to Operate Mode.

## The Test Option

Within the Service Menu, the Test option includes seven tests to ensure that the PT878GC is performing properly: Test Screen, Test Keys, Watchdog Test, Impulse Response, Wave Snapshot, Simulate and Battery Test. To enter this option, scroll to the Test entry on the Service Menu and press [ENTER]. The screen appears similar to Figure 9-20 below.

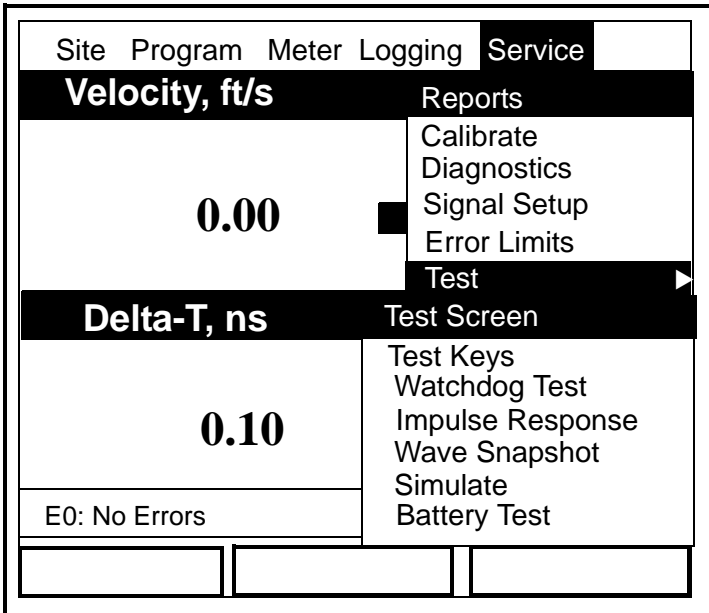

Figure 9-20: The Test Option in the Service Menu

Scroll to the desired entry in the option menu and press [ENTER].

## Testing the Screen

To test the proper functioning of the PT878GC screen, scroll to the Test Screen option in the Test Menu and press [ENTER]. The screen then shows the message, “Press Any Key To Continue.” Once you press a key, a screen with a checkerboard pattern appears, as shown in Figure 9-21 below.



**Figure 9-21: A Functioning Test Screen**

Pressing a key two more times should result in two more checkerboard patterns, followed by a series of dark and light screens. Pressing the key through this sequence should return the PT878GC to Operate Mode. If the test does not proceed according to this sequence, please consult GE Infrastructure Sensing.

## Testing the Keys

The Test Keys option checks the functioning of the various keys on the keypad. To start the test, scroll to the Test Keys option on the Test Menu and press [ENTER]. The screen appears similar to Figure 9-22 below. Press any key on the keypad, and a window representing that key should darken.

Test Keys					
	F1	F2	F3		⌘
			?	ESC	SEL
1	2	3		+	
4	5	6	+		+
7	8	9		+	
.	0	-	MENU		ENTER
					Exit

Figure 9-22: The Test Keys Window

Pressing the [F3] key returns the meter to the Operate Mode. If any key does not appear on the screen or does not darken when pressed, contact GE Infrastructure Sensing.

**Note:** *The power key does not appear in this test.*

## Testing the Watchdog Timer Circuit

The PT878GC includes a watchdog timer circuit. If a software error causes the meter to stop responding, this circuit automatically resets the meter. A properly functioning PT878GC restarts if you run the Watchdog Test.

To start the Watchdog Test, scroll to the Watchdog Test option in the Test Menu and press [ENTER]. The screen appears similar to Figure 9-23 below.

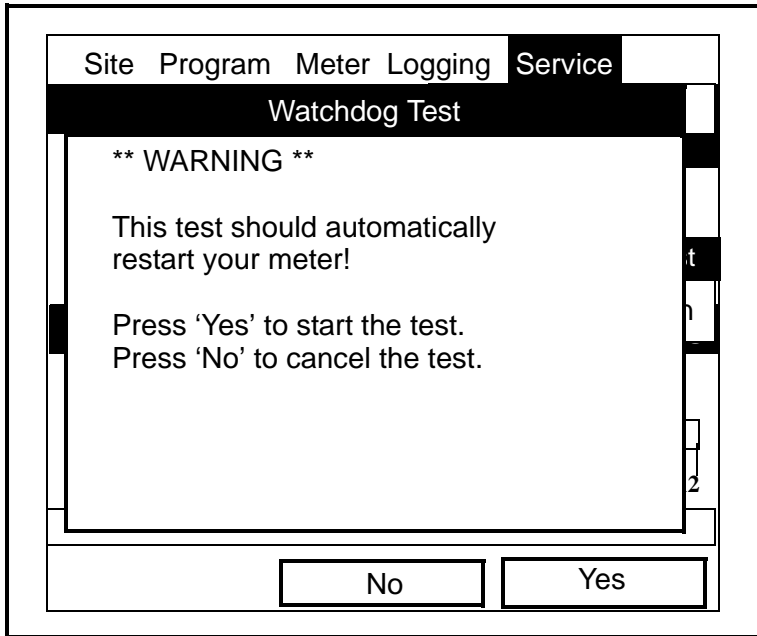

**Figure 9-23: The Watchdog Test Screen**

Press [F2] (No) to cancel the test and return to the Menu screen, or press [F3] (Yes) to start the test. The PT878GC should go blank for a few seconds, and then restart. If it does not follow this sequence, consult GE Infrastructure Sensing.

## Setting Impulse Response

The Impulse Response option enables you to force the meter to transmit in one direction only, without changing the AGC setting. You can then diagnose problems with transducer, pipe, or fluid configurations. To enter the option, scroll down to the Impulse Response entry in the Service Menu and press [ENTER]. The screen appears similar to Figure 9-24 below.

The screenshot shows a menu titled "Impulse Response" with a black header. Below the header, there are two input fields: "Direction" with the value "Upstream" and "Percent Gain" with the value "20" followed by a percent sign. Below these fields, the text "Stopped." is displayed. At the bottom of the screen, there are three buttons: "Transmit", "Stop", and "Exit".

**Figure 9-24: The Impulse Response Option**

1. The first prompt asks in which direction you wish the meter to transmit, upstream or downstream.
  - a. Press [ENTER] to open the drop-down list.
  - b. Use the [▼] or [▲] arrow keys to scroll to the desired direction.
  - c. Press [ENTER] to confirm your selection.



## Setting Impulse Response (cont.)

2. The second prompt asks for the percent of gain.
  - a. Press [ENTER] to open the text box.
  - b. Use the numeric keys to enter the desired percentage.
  - c. Press [ENTER] to confirm your entry.

You have completed entering data for the Impulse Response option.

- Press [F1] to start transmitting in the chosen direction.
- Press [F2] to stop transmitting.
- Press [F3] to leave the option and return to Operate Mode.

## Taking Wave Samples for Diagnosis

The Wave Snapshot option allows you to capture receive signals to a file that you can send to a PC for diagnostic purposes. To use this option, scroll down to the Wave Snapshot entry in the Service Menu and press [ENTER]. The PT878GC then captures three pairs of upstream and downstream raw signals to a file named Wave01.met. (If you repeat the captures, the successive files will be named Wave02.met, Wave03.met, etc.) You can then transfer the files over the IR port to a PC for analysis by a service engineer.

**Note:** *Refer to page 6-16 for information on transferring a file to a PC.*

## Applying a Stored Signal for Diagnosis

The Simulate option places the PT878GC in a mode in which it uses a stored signal (instead of the live signal from the transducers) to make flow calculations for diagnostic purposes. On the PC, you must rename a Wavexx.met file as Wave.met and send it back to the PT878GC over the IR link. Then, on the PT878GC, scroll down to the Simulate entry in the Service Menu and press [ENTER]. The PT878GC then applies the simulated signal.

**Note:** *Refer to page 6-17 for information on transferring a file from a PC to the PT878GC.*

## Testing the Battery

The Battery Test option provides additional battery information for service troubleshooting. To enter the option, scroll down to the Battery Test entry in the Service Menu and press [ENTER]. The screen appears similar to Figure 9-25 below.

The screenshot shows a service menu titled "Service Battery Form". It displays the following information:

- Status:** Fast Charge
- Run Time:** 250 Minutes
- Batt Voltage:** 5.78 Volts
- Fast Charge:** 3 Min
- Backup Battery:** OK Batt temp 27.7 °C
- Part Number:** 1.8Ahr NiCd (200-058)
- Condition Battery:** (A button with a white background and black text)
- Cancel:** (A button with a white background and black text)
- OK:** (A button with a white background and black text)

**Figure 9-25: The Battery Test Option**

The screen displays the current status (Fast Charge, On Charge, Discharging, or On Battery), the time remaining for the PT878GC to run on the battery, the time for the Fast Charge, and the current condition of the backup battery.

1. If you wish to open the Part Number window, press [ENTER]. You can choose from a 1.8 Ahr NiCd battery (part number 200-058) or a 3.0 Ahr NiMH battery (part number 200-081). Scroll to the battery type you have installed and press [ENTER].
2. To condition the batteries, press the [ENTER] key. The "Condition Battery" window should now read "Stop." The status line should change to "Discharging." (Updating the status could take up to 30 seconds.)
3. To stop the discharge cycle, press the [ENTER] key and the "Condition Battery" window reappears. The status now changes to "On Charger."
4. Press [F3], OK, to return to Operate Mode.

## Resetting to Factory Default Parameters

For various reasons, you might wish to return the PT878GC to its original settings. The Factory Defaults option enables you to return the meter to its preprogrammed default settings. To enter the option, scroll down to the Factory Defaults entry in the Service Menu and press [ENTER]. The screen will appear similar to Figure 9-26 below.

**IMPORTANT:** *All sites and logs will be lost if you use the Factory Defaults option. Be sure to transfer or print all sites and logs before resetting!*

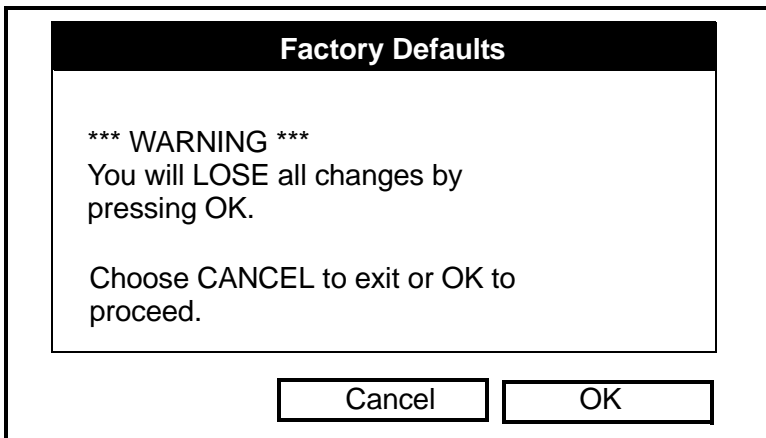

Figure 9-26: The Factory Defaults Option

1. You have two options:
  - Press [F2] (Cancel) to return to Operate Mode without changing the current settings.
  - Press [F3] (OK) to confirm that you wish to restore the factory default settings.
2. The program asks for confirmation: “Are you SURE?” Repeat the procedure shown in step 1 above.

The PT878GC replaces the default site file and the global meter settings with the factory default settings.

---

## Updating PT878GC Software

By using a Windows-based PC with an infrared adapter, PT878GC users can update the meter's operating software without the need to change the hardware. This software can include the bootloader, FPGA software (timing software for transit-time), instrument software, the meter string file and the Help string file. The updating procedure involves three steps:

1. Setting up the PT878GC in Flash Update mode.
2. Selecting the loading interface.
3. Loading the new software from the PC into the PT878GC.

---

### Caution!

To guard against mishap, you should print out, download or otherwise record all logs, settings and other data you wish to save.

---

**IMPORTANT:** *When uploading new software, the PT878GC uses a "bootloader" program. Be sure that the software you are installing is compatible with the installed bootloader version, shown in the "About" option discussed on page 6-21. If you need to replace both programs, install the new bootloader first, before any other software.*

With the current bootloader software, two interfaces are available for sending software to the PT878GC:

- IrOBEX, a recently introduced Microsoft infrared standard which allows more straightforward use and faster file transfers, while tolerating IR interruptions better.
- IrCOMM, an infrared standard supported by certain Microsoft operating systems.

GE Infrastructure Sensing recommends updating software via the IrOBEX standard; however, the IrCOMM standard is available for users who have problems with IrOBEX. This section covers procedures for both standards.

## Updating Software Via IrOBEX

To begin updating software via IrOBEX, scroll down to the Flash Update entry in the Service Menu and press [ENTER]. The screen appears similar to Figure 9-27 below.

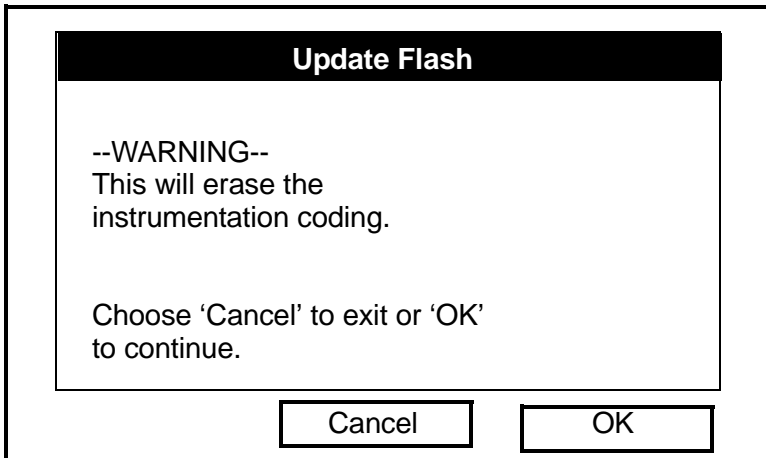

**Figure 9-27: The Flash Update Window**

- Press [F2] (Cancel) to return to Operate Mode without erasing the program.
  - Press [F3] (OK) to confirm that you wish to erase the program.
4. The meter asks for confirmation. Repeat the options shown in Step 1 above. After the PT878GC reboots, the screen appears similar to Figure 9-28 below.

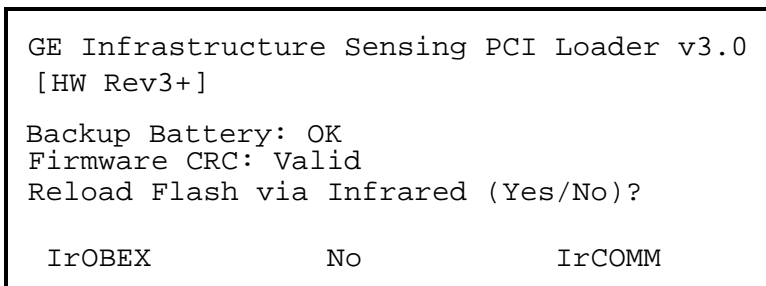

**Figure 9-28: Flash Reloading Window**

## Updating Software Via IrOBEX (cont.)

5. The meter now asks if you wish to reload the flash memory via the infrared communications port.
  - Press [F1] (Yes) to begin reloading via OBEX, or
  - Press [F2] (No) to stop the reloading procedure.

Be sure the infrared sensor on the meter has a clear path to the infrared adapter on the PC. Now return to the PC.

6. You now have two options:
  - In Windows Explorer, browse to the file you wish to send. Select and right-click on it. Select *Send To* → *Infrared Recipient* or *Nearby Computer* (or *QuickBeam* if QuickBeam has been installed).
  - Open the *Infrared Transfer Application (My Computer\Infrared Recipient)*, click on *Send Files*, and select the files you wish to send.

In either case, a window displays the status of the file upload.

## Updating Software Via IrCOMM

**Note:** *While Windows 95/98/98SE and NT (with QuickBeam) support IrCOMM, Windows 2000 and XP do not. Refer to Appendix B.*

Before you install new coding, you must be sure that the PC has the correct protocols to transmit the software to the meter.

### Setting up the PC

**Note:** *The use of Hyperterminal is shown here as an example. If you are using a different communications software, see its manual for detailed instructions.*

1. From the Start Menu, click *Programs/Accessories/Hyperterminal* to open the Hyperterminal window.
2. If the call is not connected, click on *Connect* from the Call menu in Hyperterminal.
3. From the File menu, click *Properties*. Be sure the *New Connection Properties* window is set to your virtual infrared port.

**Note:** *You can determine which virtual port your infrared is using by opening Infrared Monitor in the Control Panel and clicking on the Options tab. It displays the message, "Providing Application Support on:" and then lists the virtual infrared port, as shown in Figure 9-29 on the next page.*

## Setting up the PC (cont.)

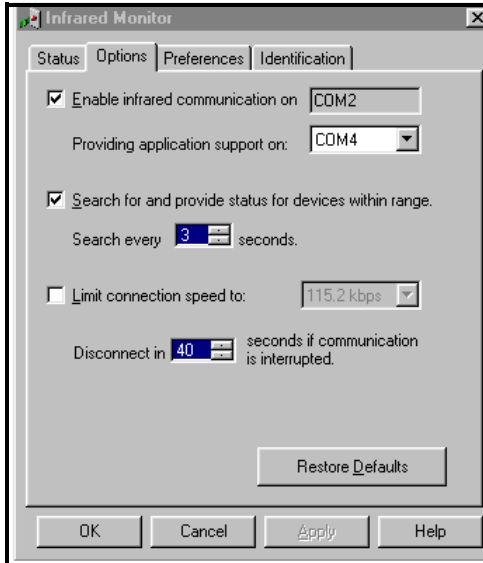

Figure 9-29: Port Settings for COMM 4

## Installing New Software

To begin the loading procedure, scroll down to the Flash Update entry in the Service Menu and press [ENTER]. The screen appears similar to Figure 9-30 below.

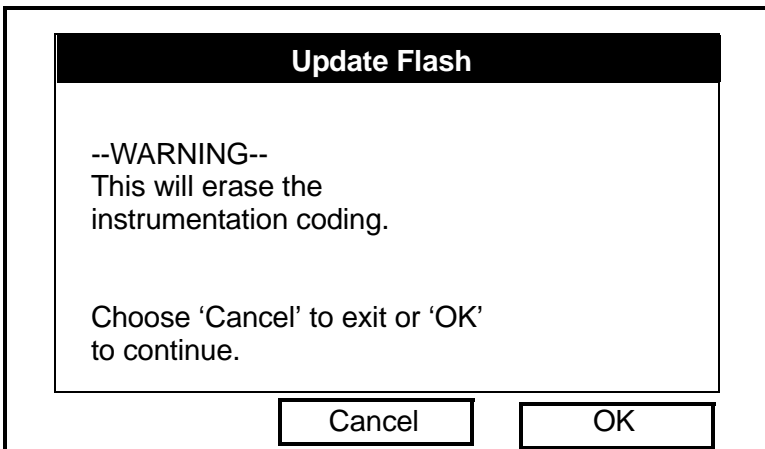

Figure 9-30: The Flash Update Option



### **Installing New Software (cont.)**

1. As shown in Figure 9-30 on the previous page, the Flash Update option erases all instrument coding.
  - Press [F2] (Cancel) to return to Operate Mode without erasing the program.
  - Press [F3] (OK) to confirm that you wish to erase the program.
2. The meter asks for confirmation. Repeat the options shown in Step 1 above. The screen on both the PC and the PT878GC now appears similar to Figure 9-31 below.

```
GE Infrastructure Sensing PCI Loader v3.
[HW Rev3+]

Backup Battery: OK
Firmware CRC: Valid
Reload Flash via Infrared (Yes/No)?

IrOBEX                No                IrCOMM
```

**Figure 9-31: Flash Reloading Window**

3. The meter now asks if you wish to reload the flash memory via the infrared communications port.
  - Press [F3] (Yes) (or C on the PC keyboard) to begin reloading via IrCOMM, or
  - Press [F2] (No) (or ESC on the keyboard) to stop the reloading procedure.
4. Be sure the infrared sensor on the meter has a clear path to the infrared adapter on the PC, and return to the PC Hyperterminal program.

## Installing New Software (cont.)

1. In the Hyperterminal window, pull down the Transfer menu and click *Send File*. A window opens similar to Figure 9-32 below.

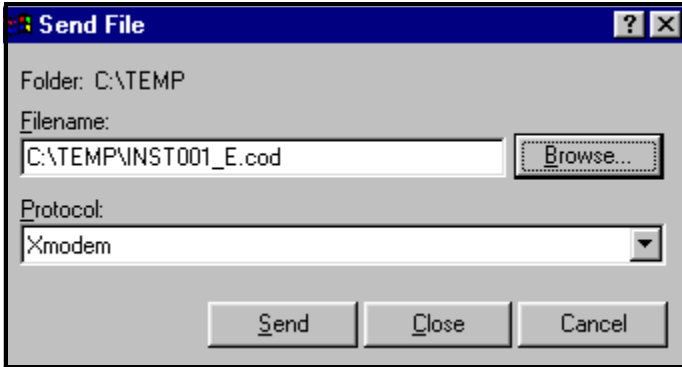

**Figure 9-32: The Send File Window in the Transfer Menu**

2. Click on the replacement software (designated by a .cod extension) from the folder where it has been stored.
3. From the Protocol drop-down menu, select Xmodem.
4. Click *Send*. For a successful transfer, the PC window appears similar to Figure 9-33 below, while the PT878GC screen displays the program ID, size, load address and a count of blocks being loaded.

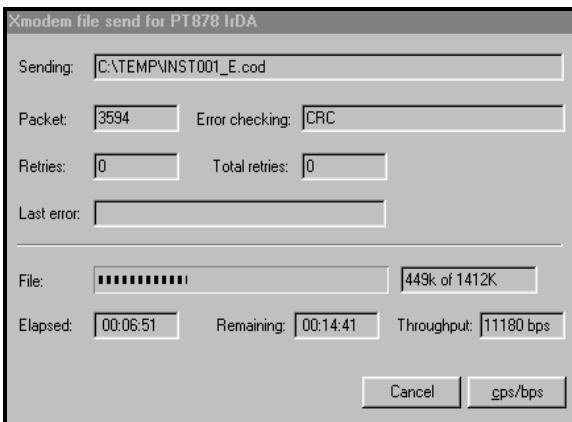

**Figure 9-33: The File Transmission Window**

# Chapter 10

## Diagnostics and Troubleshooting

---

The TransPort PT878GC is a reliable instrument that is easy to maintain. It will provide accurate flow measurement readings as long as it is operated as described in this manual. If problems do arise with the electronics, transducers or the flowcell, the TransPort displays an error message specifying the possible problem. The TransPort also has a set of diagnostic parameters to help you find and remedy the problem.

In general, troubleshooting may be necessary if the TransPort displays an error message, the flow readings are erratic, or you have other reasons to doubt the accuracy of readings (for example, readings do not agree with other flow measuring devices connected to the same process).

This section describes error messages, diagnostic parameters, and shows you how to isolate problems to one of the following areas:

- Electronics, including programmed values
- Flowcell, which includes the pipe and fluid
- Transducers and cables.

## Error Code Messages

Error Code messages appear on the screen while you are displaying measurements. When logs appear in graph form, errors are indicated by a vertical gray bar at the point of error. When they appear in a spreadsheet format, errors are indicated by their number in the last row, called “Error.” The Error Code messages are only general descriptions of the possible problems. Use Table 10-1 on page 10-3 to isolate and remedy the problem. If you are unable to remedy the problem, contact GE Infrastructure Sensing.

**Note:** *We suggest that, in order to isolate the indicated problem more easily, you obtain a test flowcell. Contact GE Infrastructure Sensing for details.*

**Table 10-1: Error Messages**

<b>Error Message</b>	<b>Problem</b>	<b>Possible Cause</b>	<b>Action</b>
E0	No error.	Displays briefly after the display of another error message	None required. Measurement is valid.
E1	Low Signal - Poor ultrasonic signal strength.	Broken cable. Flowcell problem. Transducer problem. Electronic failure.	Check transducer cable. See Flowcell Problems on page 10-9 and Transducer Problems on page 10-11. Check programming and transducer spacing. Contact the factory if problem persists.
E2	Sound Speed Error (Sound speed is programmed using the Program Menu Pipe option. as described in Chapter 4.)	Poor flow conditions. Incorrect programming. Bad transducer spacing. Measurement is very different from the programmed sound speed.	Check sound speed against nominal sound speed. See Flowcell Problems on page 10-9 and Transducer Problems on page 10-11. Check programming and transducer spacing.

**Table 10-1: Error Messages (cont.)**

<b>Error Message</b>	<b>Problem</b>	<b>Possible Cause</b>	<b>Action</b>
E3	Velocity Range - Velocity exceeds programmed limits. (Velocity limit is programmed using the Service Menu Error Limits option as described in Chapter 9.)	Programming error, poor flow conditions, or bad transducer spacing.	Make sure the maximum velocity range is within the range listed in Table 3-1 on page 3-4 for the pipe size and pressure. Check programming and transducer spacing. If programmed value is outside of limit, change the limits as described in Chapter 9 on page 9-32. See Flowcell Problems on page 10-9 and Transducer Problems on page 10-11.
E4	Signal Quality	If too high - electronic failure. If too low - flowcell, electrical problem.	Check for source of electrical interference. Check electronics with a test flowcell. Check to see if the velocity is above the maximum value. Check to see if the pressure is above the minimum required pressure for the pipe OD/WT. If unit still fails to operate, contact the factory
E5	Amplitude Error	Excessive particles or liquid present in fluid. A lot of second phase present	See Flowcell Problems on page 10-9.

**Table 10-1: Error Messages (cont.)**

<b>Error Message</b>	<b>Problem</b>	<b>Possible Cause</b>	<b>Action</b>
E6	Cycle skip, Acceleration	Poor flow conditions or bad transducer spacing.	Check transducer spacing as programmed and as set on pipe. See Flowcell Problems on page 10-9 and Transducer Problems on page 10-11.
E7	Analog Out Error	Under current output.	Check that output load is within specification <550 ohm.
E16	High Signal	Entry of improper value in Transducer or Pipe submenus.	Check values in Transducer and Pipe submenus. Remove preamp.
E17	Equation Limit	(Steam equations only) Process temperature and/or pressure are outside valid limits of Steam Equations for mass flow.	Adjust the pressure reading to within the range of 139.9685 kPa to 2242.9435 kPa, or the temperature reading to within the range of 373.1500K to 810.9278K.
E18	Supersaturated	(Steam equations only) Process temperature is below the saturation temperature of steam for the process pressure.	Raise the system temperature or lower the system pressure until all the water vaporizes.

## Displaying Diagnostic Parameters

As part of its measurement menu, the PT878GC offers a list of diagnostic parameters to aid in troubleshooting in the event of flowcell, transducer, or electrical problems. You can select any diagnostic parameter for display as a measurement as discussed in Chapter 6 on pages 6-7 and 6-8. Table 10-2 below shows all the available diagnostic parameters and ranges.

**Table 10-2: Diagnostic Parameters**

Diagnostic Parameter	Displays	Good	Bad
$\Delta T$	Displays Delta T, or the difference between the upstream and downstream transit times.	N/A	Continuous large fluctuations of 1 micro second or more.
Amplitude Up	Displays the value for the amplitude discriminator of the upstream transducer.	20-28	<20 or > 28.
Amplitude Down	Displays the value for the amplitude discriminator of the downstream transducer.	20-28 fluctuations	< 20 or > 28 fluctuations
T Up	Displays the upstream transit time of the ultrasonic signal in micro seconds.	N/A	N/A
T Down	Displays the downstream transit time of the ultrasonic signal in micro seconds.	N/A	N/A
Gain/Up	Displays upstream gain in dB.	N/A	N/A
Gain/Dn	Displays downstream gain in dB.	N/A	N/A
CNTup	Displays the AGC DAC count for upstream gain setting.	N.A.	N.A.
CNTdn	Displays the AGC DAC count for downstream gain setting.	N.A.	N.A.



**Table 10-2: Diagnostic Parameters (cont.)**

<b>Diagnostic Parameter</b>	<b>Displays</b>	<b>Good</b>	<b>Bad</b>
Sound speed (m/s or f/s)	Displays the measured sound speed of the fluid.	Check the sound speed of fluid in <i>Sound Speeds and Pipe Size Data</i> .	
P#up	Displays signal peaks for the upstream transducer.	100-900	<100, >900
P#dn	Displays signal peaks for the downstream transducer.	100-900	<100, >900
Reynolds #	Displays the Reynolds Number.	N/A	N/A
K(RE)	Displays the K Factor, based on the Reynolds Number.	N/A	N/A
Raw Up	Displays raw upstream signal.	N/A	N/A
Demod Up	Displays demodulated upstream signal.	N/A	N/A
Skam Corr Up	Displays skam correlation upstream signal.	N/A	N/A
Raw Down	Displays raw downstream signal.	N/A	N/A
Demod Down	Displays demodulated downstream signal.	N/A	N/A
Skam Corr Down	Displays skam correlation downstream signal.	N/A	N/A
Xmit Corr Up	Displays raw upstream signal correlated with transmit signal.	N/A	N/A
Xmit Corr Dn	Displays raw downstream signal correlated with transmit signal.	N/A	N/A
Cross Corr	Displays transmit upstream signal correlated with transmit downstream signal.	N/A	N/A
Signal up	Displays the signal strength for the upstream transducer.	50-80	<50
Signal dn	Displays the signal strength for the downstream transducer.	50-80	<50
Qup	Displays the signal quality for the upstream transducer.	±300 or higher	between ±100

**Table 10-2: Diagnostic Parameters (cont.)**

<b>Diagnostic Parameter</b>	<b>Displays</b>	<b>Good</b>	<b>Bad</b>
Qdown	Displays the signal quality for the downstream transducer.	$\pm 300$ or higher	between $\pm 100$
Norm Factor	Displays the normalization factor.	0.85 - 1.0	$< 0.85$
Threshold Up	Displays the Percent of Peak for the upstream transducer. Set to -40 by default.	N/A	N/A
Threshold Dn	Displays the Percent of Peak for the downstream transducer. Set to -40 by default.	N/A	N/A
SNRup	Displays the signal/noise ratio for the upstream transducer.	N/A	N/A
SNRdn	Displays the signal/noise ratio for the downstream transducer.	N/A	N/A
Voltage	Displays remaining battery voltage.	5.75-7.5	$< 5.25$
Time Remaining	Displays estimated battery time remaining.	N/A	N/A

---

## Flowcell Problems

Flowcell problems fall into two categories: gas problems and pipe problems. Read the following sections carefully to determine if such problems exist.

### Gas Problems

Most gas-related problems can be solved by proper design of the flowmeter installation and the proper choice of transducer frequency. Contact GE Infrastructure Sensing if you cannot solve a gas-related problem.

If the physical installation of the system meets the recommended specifications, it is possible that the gas itself may be preventing accurate flow rate measurements. The gas being measured must meet the following requirements:

- 1. THE GAS MUST BE HOMOGENOUS, SINGLE-PHASE AND RELATIVELY CLEAN.** Although a low level of entrained particles may have little effect on the operation of the TransPort, excessive amounts of solid or liquid particles will absorb or disperse the ultrasound signals. This interference with the ultrasound transmissions through the gas will cause inaccurate flow rate measurements. In addition, temperature gradients in the gas flow may result in erratic or inaccurate flow rate readings.
- 2. THE GAS MUST NOT EXCESSIVELY ATTENUATE ULTRASOUND SIGNALS.** Some gases (i.e., high-purity carbon dioxide, hydrogen, helium, etc.) readily absorb ultrasound energy. In these cases an “E1” will appear on the screen to indicate that the ultrasonic signal is insufficient for reliable measurements.

## Fluid Problems (cont.)

3. **THE GAS SOUND SPEED MUST NOT VARY EXCESSIVELY.** The TransPort will tolerate relatively large, changes in gas sound speed due to changes in gas composition and temperature. However, such changes must occur slowly. Rapid fluctuations in the gas sound speed, to a value that is considerably different from that programmed into the PT878GC, will result in erratic or inaccurate flow rate readings. Refer to Chapter 4, *Programming Site Data*, pages 4-13 and 4-14.

## Pipe Problems

Improper pipe conditions and/or flowcell installation can cause problems with measurement of the gas flow. Contact GE Infrastructure Sensing if you cannot solve pipe-related problems. By far, the most common pipe problems are the following

1. **THE COLLECTION OF MATERIAL AT THE TRANSDUCER LOCATION(S).** Accumulated debris at the transducer locations(s) will interfere with transmission of the ultrasound signals. As a result, accurate flow rate measurements are not possible. Realignment of the flowcell or transducers often cures such problems. Refer to Chapter 3 for proper transducer installation.
2. **INACCURATE PIPE MEASUREMENTS.** The accuracy of the flow rate measurements is no better than the accuracy of the programmed pipe dimensions. For a flowcell supplied by GE Infrastructure Sensing, the correct data will be included in the documentation. For other flowcells, measure the pipe wall thickness and diameter with the same accuracy desired in the flow rate readings. Also, check the pipe for dents, eccentricity, weld deformity, straightness and other factors that may cause inaccurate readings. Refer to Chapter 4, *Programming Site Data*, pages 4-7 to 4-10, for instructions on programming the pipe data.

---

## Transducer Problems

Ultrasonic transducers are rugged, reliable devices. However, they are subject to physical damage from mishandling and chemical attack. The most common transducer problems are listed below.

1. **LEAKS:** Leaks may occur around the transducer and/or the flowcell fittings. Repair such leaks immediately. If the leaking gas is corrosive, carefully check the transducer and cables for damage, after the leak has been repaired.
2. **CORROSION DAMAGE:** If the transducer material was not properly chosen for the intended application, the transducers may suffer corrosion damage. The damage usually occurs either at the electrical connector or on the transducer surface. If corrosion is suspected, remove the transducer from the flowcell and carefully inspect the electrical connector and the transducer surface for roughness and/or pitting. Any transducer damaged in this manner must be replaced. Contact GE Infrastructure Sensing for information on transducers in materials suitable for the application.
3. **INTERNAL DAMAGE:** An ultrasonic transducer consists of a ceramic crystal bonded to the transducer case. The bond between the crystal and the case, or the crystal itself, may be damaged by extreme mechanical shock and/or temperature extremes. Also, the internal wiring can be corroded or shorted if contaminants enter the transducer housing.
4. **PHYSICAL DAMAGE:** Transducers may be physically damaged by dropping them onto a hard surface or striking them against another object. The transducer connector is the most fragile part and is the one most subject to damage. Minor damage may be repaired by carefully bending the connector back into shape. If the connector cannot be repaired, the transducers must be replaced.

**Note:** *Transducers must be replaced in pairs. Refer to Chapter 4, Programming Site Data, to program the replacement transducer data into the meter.*

Contact GE Infrastructure Sensing if you cannot solve a transducer-related problem.

# Chapter 11

## Specifications

---

This section contains specifications for the following:

- Operations and Performance
- Electronics
- Clamp-on Transducers
- Thickness Gauge Option
- Additional Options

## Operation and Performance

### Fluid Types

Acoustically conductive gases with minimum density requirements. See Table 3-1 on page 3-4.

### Pipe Sizes

0.75 to 12 in. (20 to 300 mm) with PT878GC-01 electronics

4 to 24 in. (101.6 to 609.6 mm) with PT878GC-02 electronics

### Pipe Wall Thickness

See Table 3-1 on page 3-4.

### Pipe Materials

All unlined metals and plastics; no lined pipes.

### Clamp-On Flow Accuracy (Velocity)

For pipes 6 in. (150 mm) and smaller:  $\pm 2\%$  to 5% of reading typical

For pipes over 6 in. (150 mm):  $\pm 1\%$  to 2% of reading typical

**Note:** *Accuracy depends on pipe size and whether measurement is one-path or two-path. Accuracy to  $\pm 0.5\%$  of reading may be achievable with process calibration.*

### Repeatability

$\pm 0.2$  to 0.5% of reading

### Range (Bidirectional)

See Table 3-1 on page 3-4.

### Rangeability (Overall)

150:1

---

## Operation and Performance (cont.)

**Note:** *Specifications assume a fully developed flow profile (typically 20 diameters upstream/10 diameters downstream straight run) and flow velocity greater than 5 ft/s (1.5 m/s). Pipes 2 in. (50 mm) or less require a minimum of 10 ft (3 m) of continuous straight run without flanges, welds or coupling joints.*

### Pressure Requirements, Air

See Table 3-1 on page 3-4.

### Pressure Requirements, Other Gases

Dependent upon gas composition, and pipe size and material. Consult GE Infrastructure Sensing.

### Measurement Parameters

Standard and actual volumetric flow, flow velocity and mass flow.



## Electronics

### Flow Measurement

Patented Correlation Transit-Time mode

### Enclosures

Submersible IP67

### Dimensions

Weight: 3 lb (1.36 kg)

Size: (h x w x d) 9.4 x 5.5 x 1.5 in. (238 x 138 x 38 mm)

### Display

240- x 200-pixel backlit LCD graphic display

### Keypad

25-key rubberized tactile membrane keypad

### Internal Battery

Rechargeable battery: 8 hours of continuous operation

### Battery Charger Input

100 to 250 VAC, 50/60 Hz, 0.38 A

### Memory

FLASH memory; field upgradable

### Operating Temperature

-20° to 55°C (-4° to 131°F)

### Storage Temperature

-40° to 70°C (-40° to 158°F)

**Note:** *To ensure maximum battery life, storage temperature exceeding 35°C (95°F) is not recommended for more than one month.*

## Standard Inputs/Outputs

- One 0/4- to 20-mA current output
- One user-selectable pulse (solid state, 5-V maximum) or frequency (5-V square wave; 100 to 10,000 Hz)
- Two 4- to 20-mA analog inputs with switchable power supply for loop-powered temperature or pressure transmitters

## Digital Interfaces

Infrared communication port for printer or PC interface

## Site Parameter Programming

- Menu driven operator interface using keypad and "soft" functions keys
- On-line help functions including pipe tables
- Storage for saving site parameters

## Data Logging

- Memory capacity to log over 100,000 flow data points
- Keypad programmable for log units, update times, start and stop time

## Display Functions

- Graphic display shows flow in numerical or graphic format
- Displays logged data
- Extensive diagnostic parameters

## European Compliance

Battery-powered system complies with EMC Directive 89/336/EEC, and transducers comply with PED 97/23/EC for DN<25.

## Clamp-On Ultrasonic Flow Transducers

### Temperature Range(s)

Standard:  $-40^{\circ}$  to  $130^{\circ}\text{C}$  ( $-40^{\circ}$  to  $266^{\circ}\text{F}$ )

Optional (overall range):  $-40^{\circ}$  to  $230^{\circ}\text{C}$  ( $-40^{\circ}$  to  $446^{\circ}\text{F}$ )

### Transducer Materials

Stainless steel and plastic

### Fixture Materials

Anodized aluminum blocks with stainless steel rod, chain or strap

### Mountings

- 3/4 to 1.25 in. (76 to 42.2 mm) pipe: CFG-V1
- 1.25 to 4 in. (32 to 102 mm) pipe: CFG-V4
- 4 to 8 in. (102 to 203 mm) pipe: CFG-V8
- 8 to 12 in. (203 to 305 mm) pipe: CFG-V12
- 12 to 24 in. (305 to 609.6 mm) pipe: CFG-PI

### Mounting Couplant

CPL-16

### Area Classifications

- Standard: General purpose
- Optional: Weatherproof NEMA 4, IP65
- Optional: Explosionproof Class I, Div 1, Groups C,D
- Optional: Flameproof e II 2 G EEx md IIC T6-T3  
(certification pending)

**Note:** *PT878GC electronics are designed for general purpose areas.*

## **Transducer Cables**

- **Standard:** One pair of LEMO® coaxial transducer connectors with 25-ft (8-m) cables
- **Optional:** 500-ft (152-m) extension cables available for most transducers

## Thickness Gauge Option

### Transducer

GE Infrastructure Sensing dual element transducer

### Pipe Thickness Range

0.05 to 3 in. (1.3 to 76.2 mm)

### Pipe Materials

Most standard metal and plastic pipe materials

### Accuracy

±1% typical or ±0.002 in. (±0.05 mm)

### Thermal Exposure

Continuous operation to 37°C (100°F); Intermittent operation to 260°C (500°F) for 10 sec followed by 2 min air cooling

---

## Additional Options

### PC Communication

The PT878GC communicates with a PC through the infrared interface and Windows® operating systems. Consult the manual for details on sites, logs and other operations with a PC.

### RS232-to-Infrared

IR adapter plugs into any available serial port to give desktop PCs infrared capability.

### Printer

- Infrared, portable, thermal printer with rechargeable battery and 120- to 240-VAC power supply/recharger
- 13 oz (370 g); 6.3 x 6.5 x 2.3 in. (160 x 164.2 x 59 mm); print width 4 in. (104 mm).

# Appendix A

## Menu Maps

---

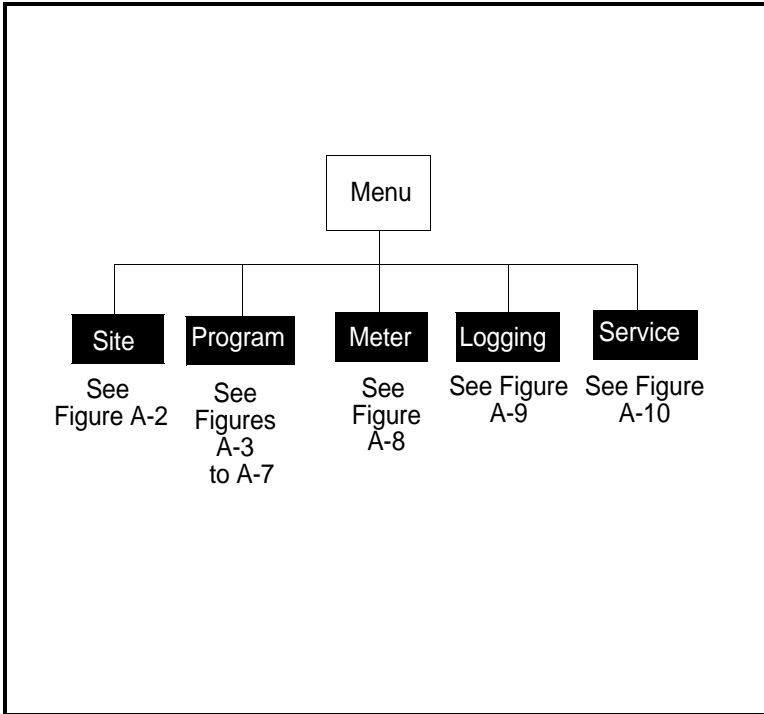

Figure A-1: The Main Menu

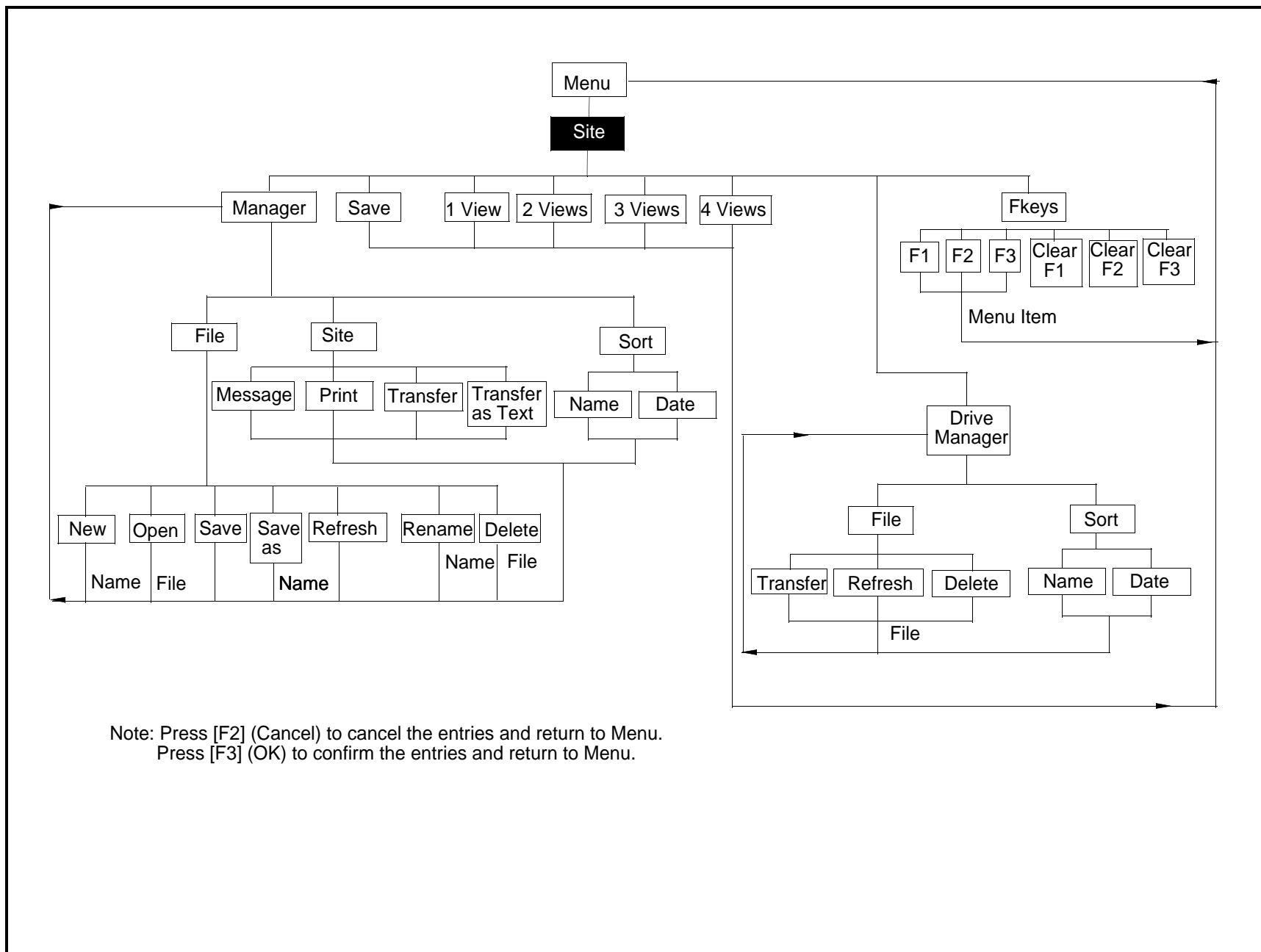

Figure A-2: The Site Menu

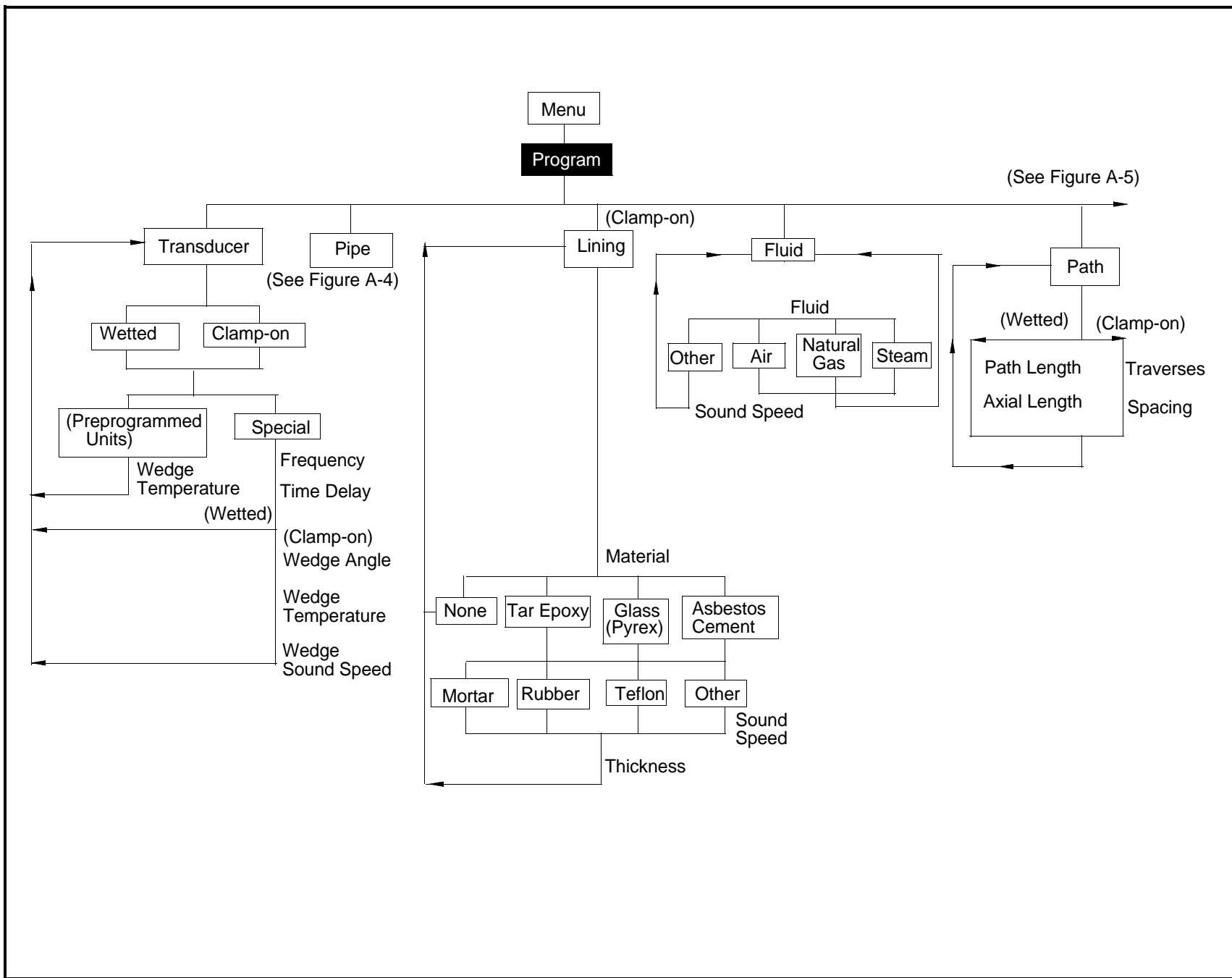

Figure A-3: The Program Menu:Transducer, Lining, Fluid and Path Options



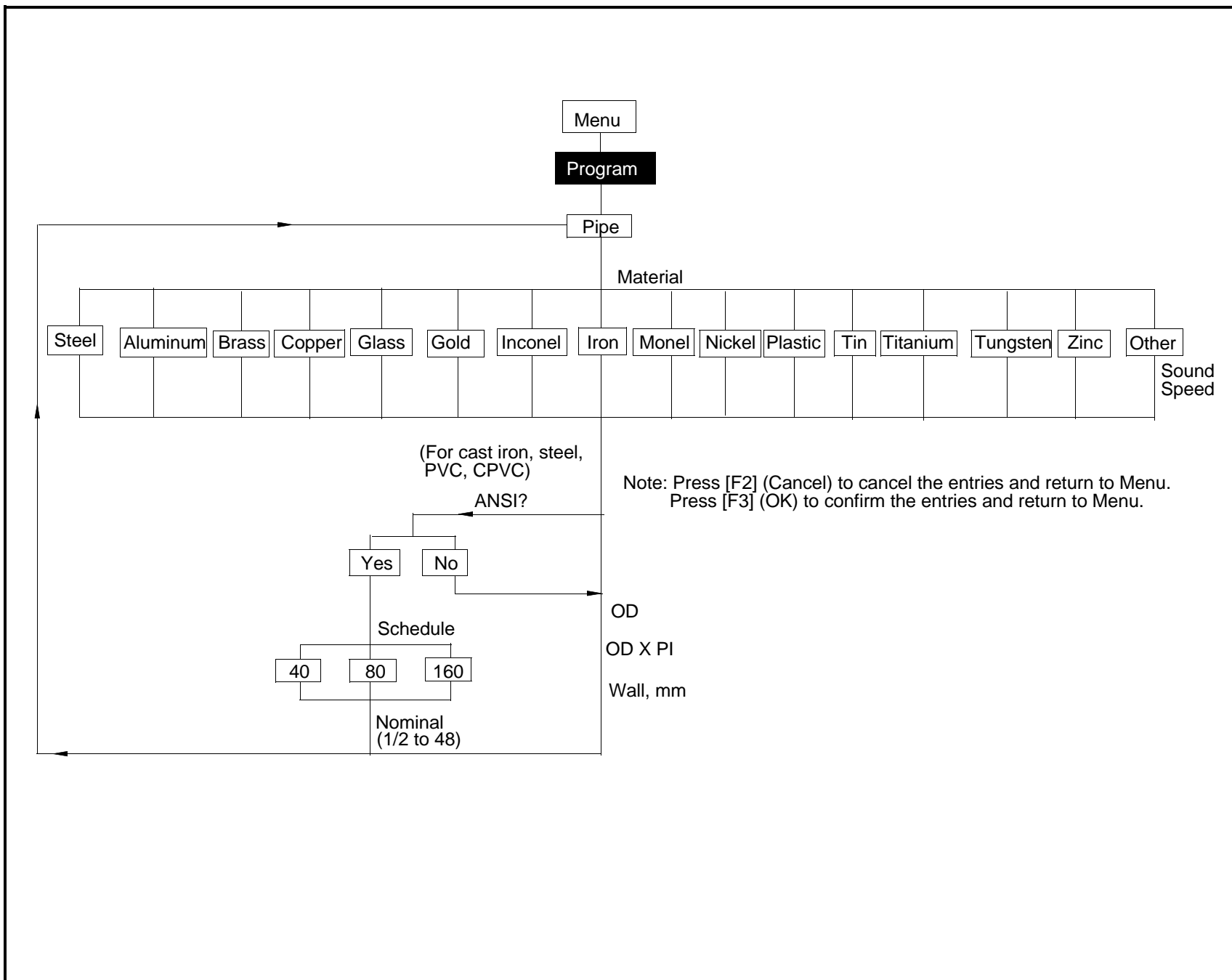

Figure A-4: The Program Menu: Pipe Option

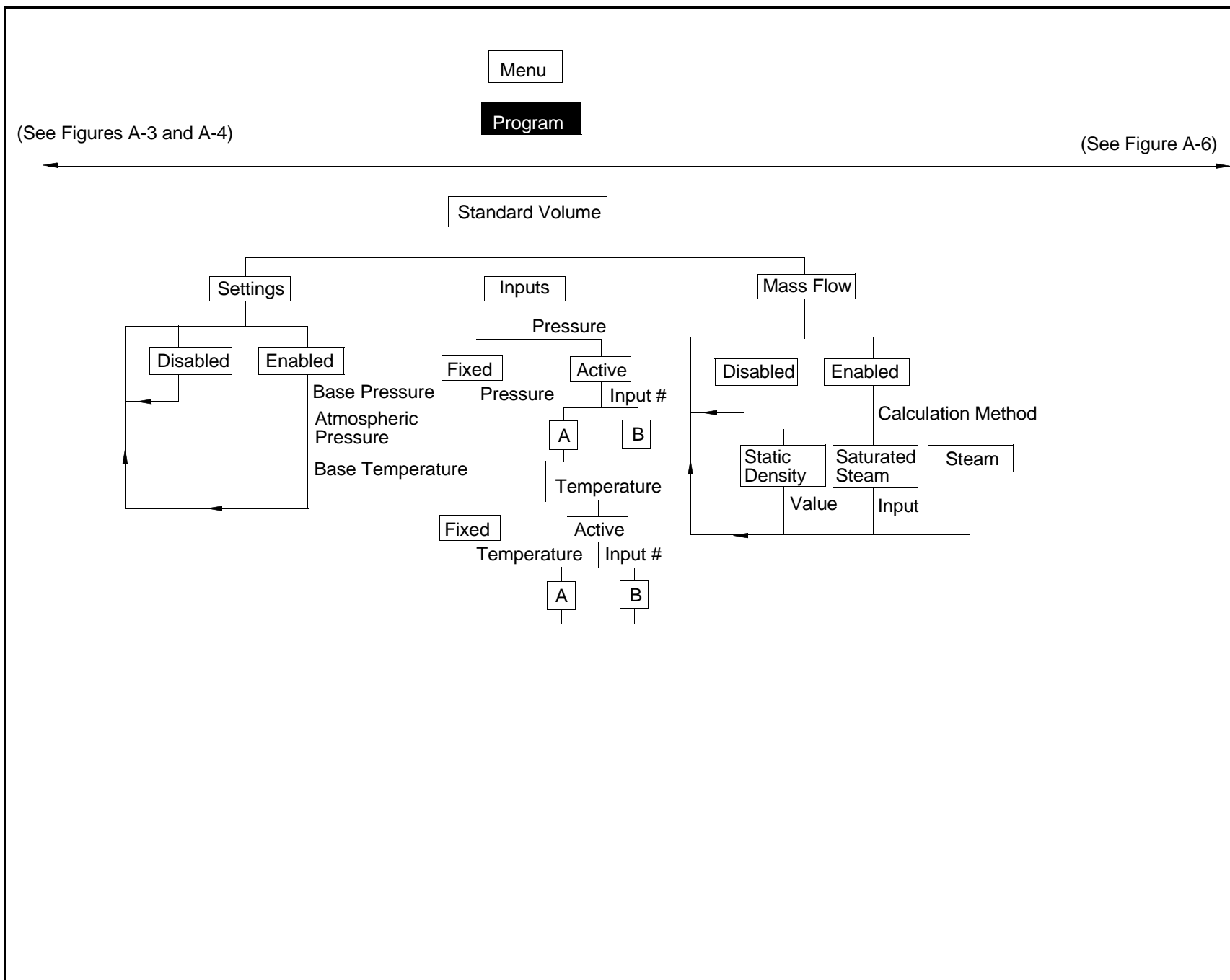
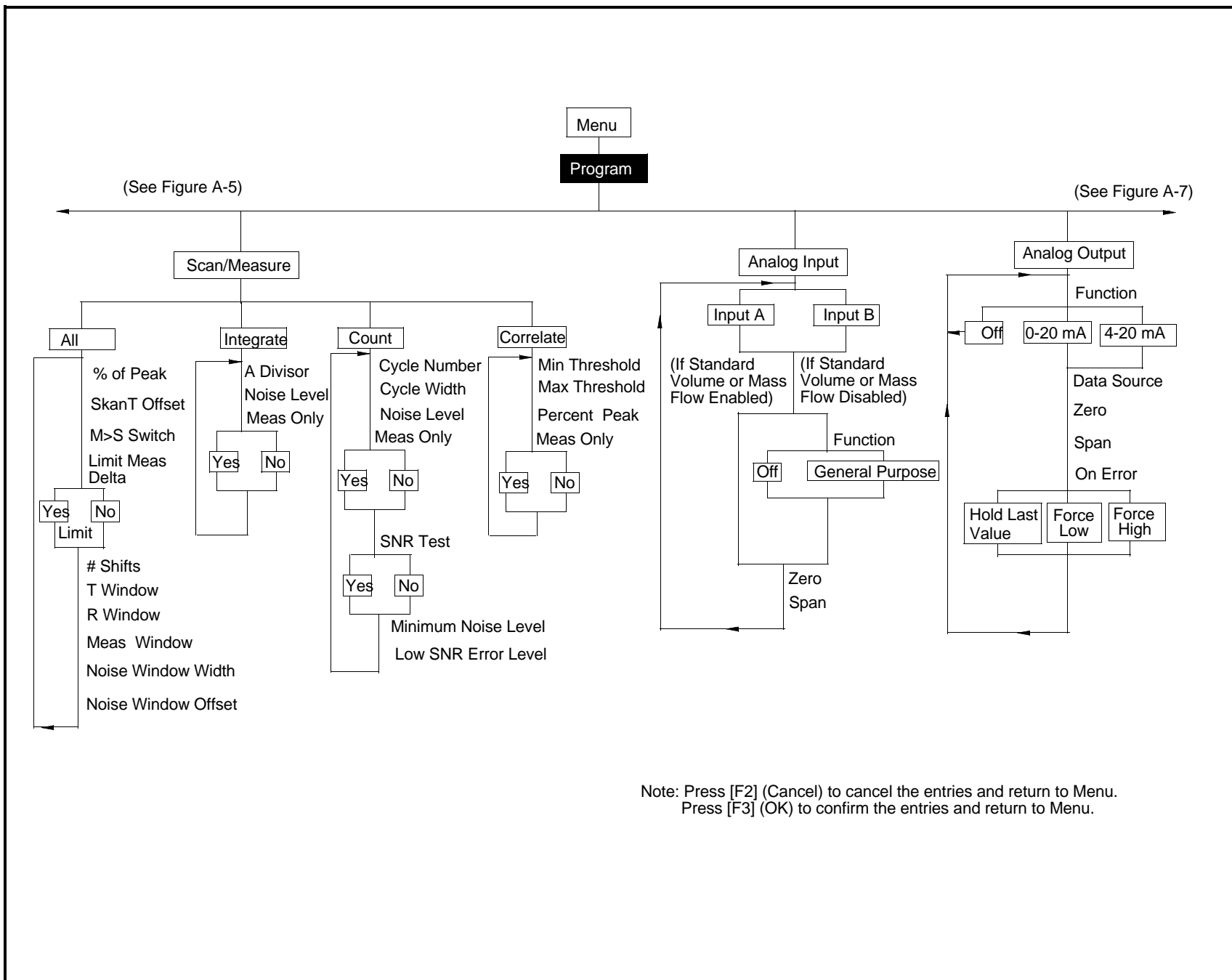
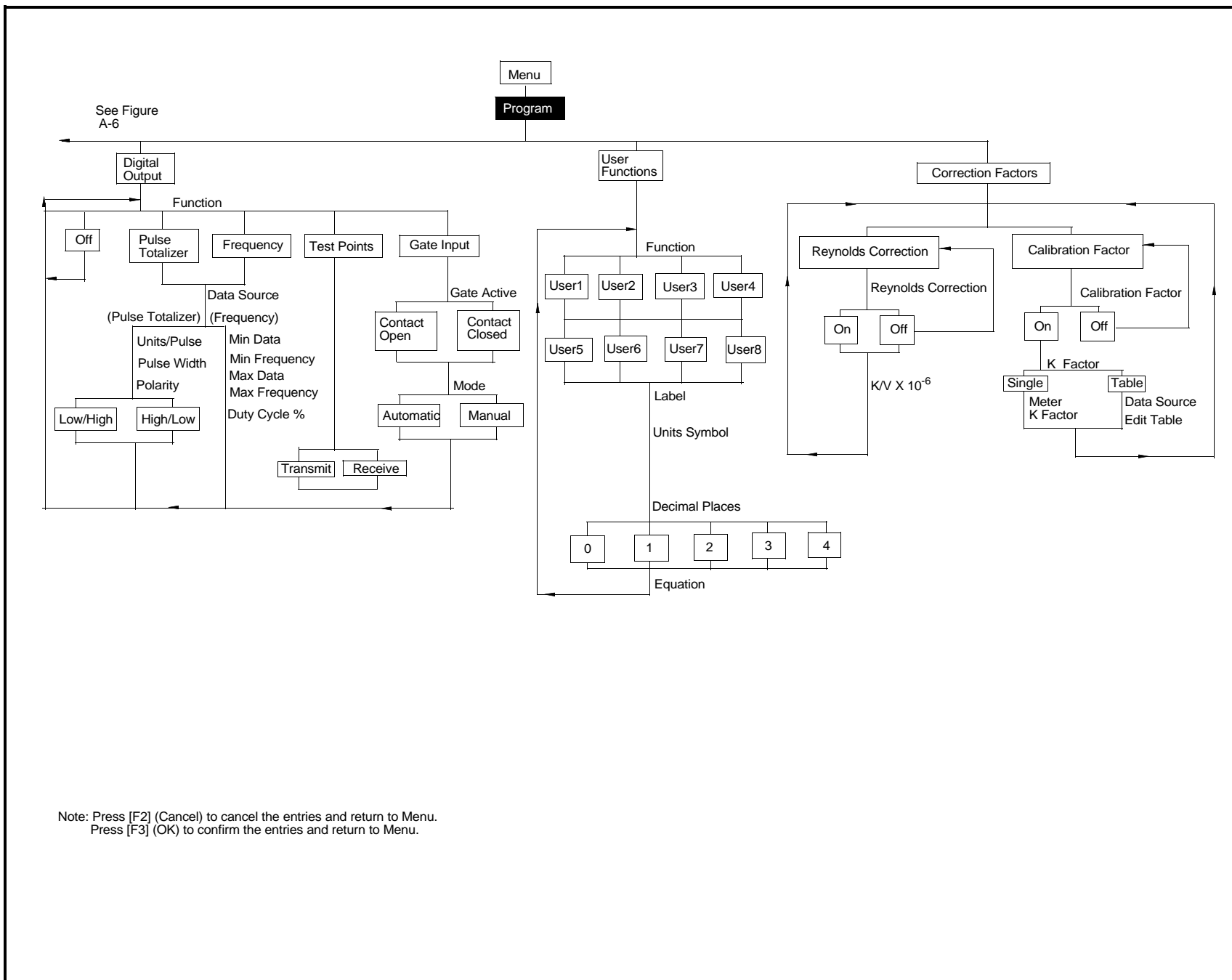

Figure A-5: The Program Menu: Standard Volume Option



Note: Press [F2] (Cancel) to cancel the entries and return to Menu.  
Press [F3] (OK) to confirm the entries and return to Menu.

Figure A-6: The Program Menu: Scan/Measure, Analog Input and Analog Output Options



Note: Press [F2] (Cancel) to cancel the entries and return to Menu.  
 Press [F3] (OK) to confirm the entries and return to Menu.

Figure A-7: The Program Menu: Digital Output, User Function and Correction Factor Options

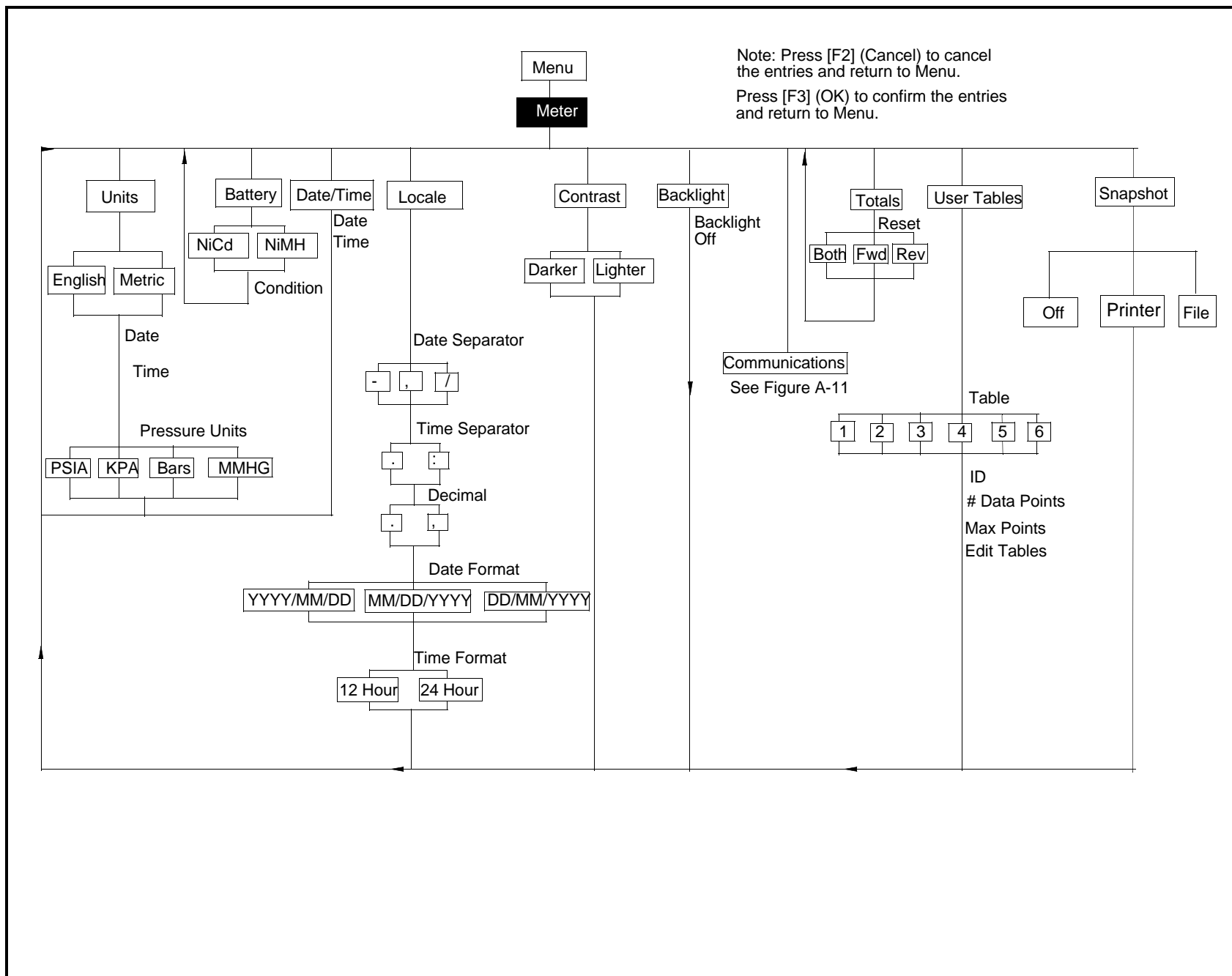

Figure A-8: The Meter Menu

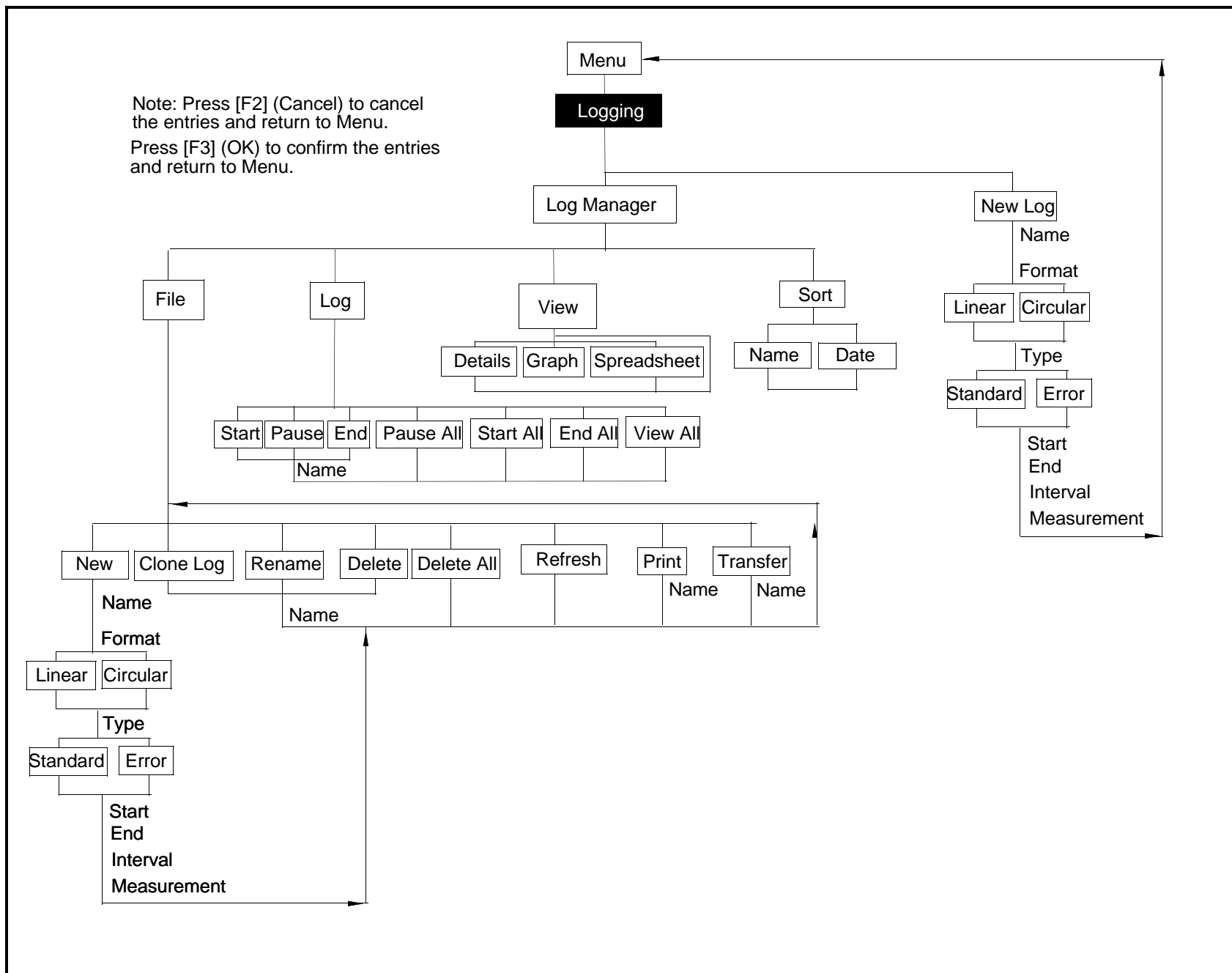

Figure A-9: The Logging Menu

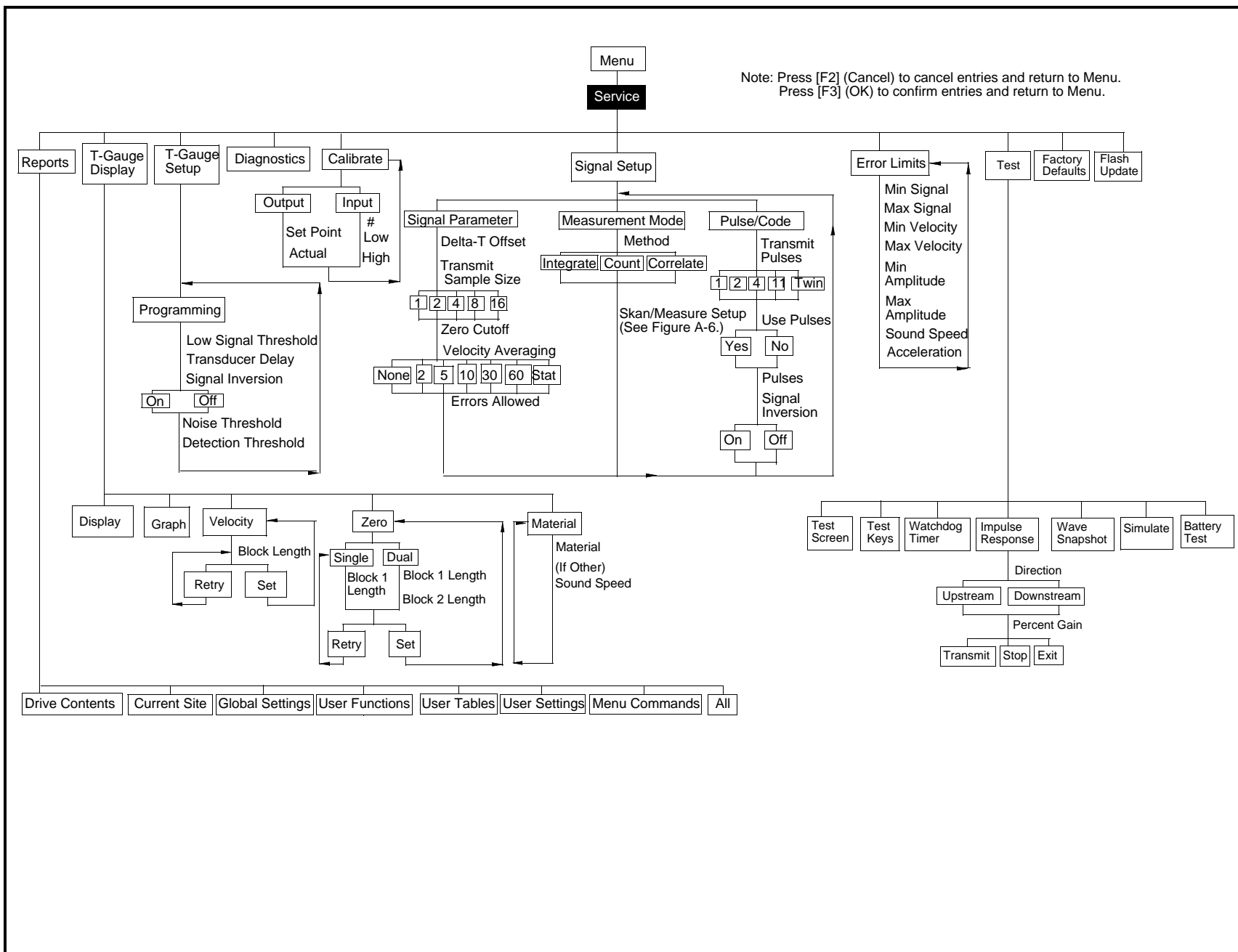
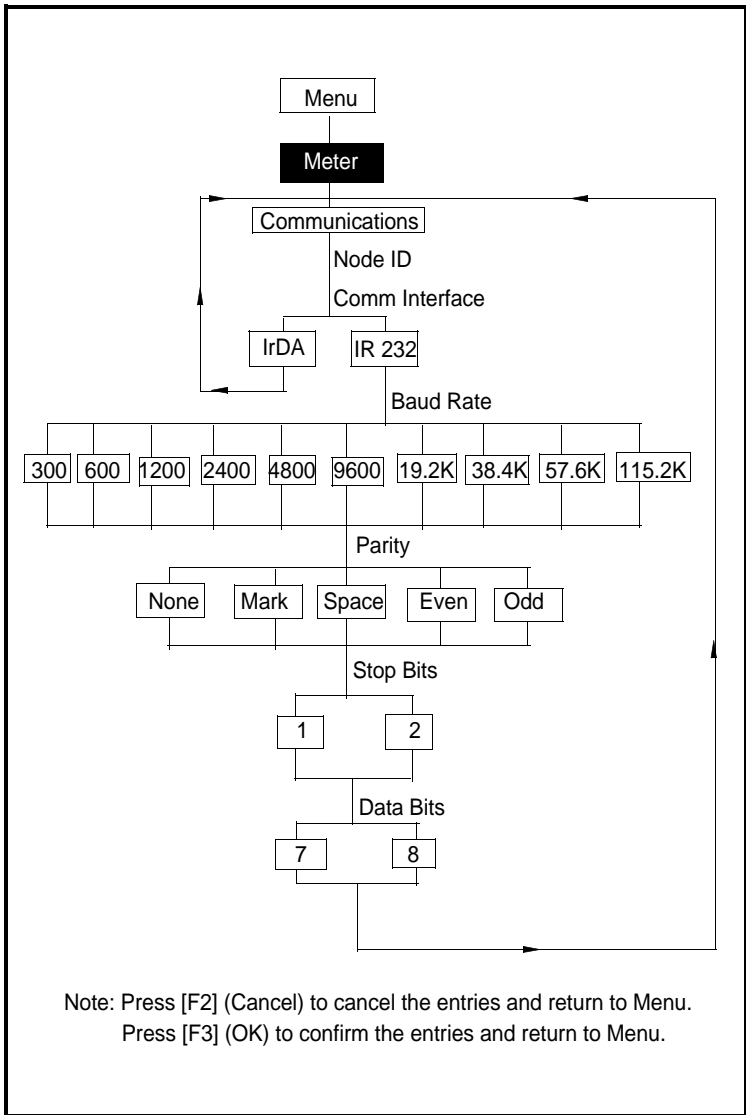

Figure A-10: The Service Menu



Note: Press [F2] (Cancel) to cancel the entries and return to Menu.  
Press [F3] (OK) to confirm the entries and return to Menu.

**Figure A-11: The Communications Option**



## Appendix B

# Establishing IR Communications with the PT878GC

---

As discussed in Chapter 2, the PT878GC includes an infrared transceiver for communication with IR products that comply with the IrDA protocol. However, you must also be sure that the operating system of your personal computer offers IrDA compatibility and either a built-in IR port (available on most laptops) or an IR dongle (IR to RS232 adapter for PCs without a built-in IR port). If your PC does not have an IR dongle, GE Infrastructure Sensing recommends the ActiSys ACT-IR220L+ infrared to RS-232 adapter, which has been tested for compatibility with the PT878GC. Be sure to position the interface in a way that permits transmission between the interface and the infrared sensor on the PT878GC, shown in Figure 2-2 on page 2-2.

Table B-1 on the next page lists IrDA compatibility for various past and current Microsoft Windows operating systems. IrCOMM is an infrared standard supported by Microsoft, while OBEX is a newer infrared standard which allows more straightforward use and faster file transfers, while tolerating IR interruptions better.

**Table B-1: IrDA Compatibility of Windows Operating Systems**

<b>Operating System</b>	<b>IrCOMM</b>	<b>OBEX</b>
Windows XP	No	Yes
Windows 2000	No	Yes
Windows NT 4.0	QuickBeam*	QuickBeam*
Windows Me*	Yes	Yes
Windows 98 SE*	Yes	Yes
Windows 98*	Yes	Yes
Windows 95*	Yes	Yes
Windows 3.1	No	No
DOS 6.22	No	No

\*May require QuickBeam installation under some circumstances when Windows built-in support fails. QuickBeam is a recommended infrared file software transfer utility from Extended Systems, Inc. Since Windows NT4.0 has no built-in support for IR file transfer, QuickBeam is necessary with this operating system.

### **Windows 2000/XP**

Both Windows 2000 and XP include infrared drivers in their operating systems. From the *Control Panel*, click on *Add New Hardware* and select the appropriate IR port, whether built-in or using an external dongle.

### **Windows NT4.0**

For IR use, Windows NT4.0 requires installation of QuickBeam software from Extended Systems ([www.extendedsystems.com](http://www.extendedsystems.com)). Desktop PCs and laptops without built-in IR ports also require adding an IR dongle. While laptops with a built-in IR port normally do not require a dongle, its addition might be necessary in some cases.

### **Windows Me/98SE/98/95**

The Windows 98SE and Me operating systems include IR drivers. However, in most cases, the IR port has not been installed or configured. From the *Control Panel*, click on *Add New Hardware* and select *Choose Device From List*. Select *Infrared* from the list and then select the appropriate infrared port, whether built-in or external.

**Note:** *In some instances, the infrared port must be enabled in the BIOS of your PC. Consult your computer documentation, manufacturer or MIS department. Assistance is also available from the Microsoft Support Knowledge Base at <http://support.microsoft.com>.*

## Appendix C

# Ultrasonic Thickness Gauge Theory of Operation

---

All ultrasonic thickness gauging involves timing the round trip of a sound pulse in a test material. Because solid metal has an acoustic impedance that differs from that of gases, liquids, or corrosion products such as scale or rust, the sound pulse will reflect from the far surface of the remaining metal. The test instrument is programmed with the velocity of sound in the test material, and computes the wall thickness from the simple formula

$$\text{Distance} = \text{Velocity} \times \text{Time}$$

Single element transducers use one element as both transmitter and receiver. Dual element transducers incorporate separate transmitting and receiving elements. These elements are mounted on delay lines that are usually cut at an angle to the horizontal plane (the roof angle), so that the transmitting and receiving beam paths cross beneath the surface of the test piece. This crossed-beam design of duals provides a pseudo-focussing effect that optimizes measurement of minimum wall thickness in corrosion applications. Duals are more sensitive than single element transducers to echoes from the base of pits that represent minimum remaining wall thickness. Also, duals may often be used more effectively on rough outside surfaces. Couplant trapped in pockets on rough sound entry surfaces can produce long, ringing interface echoes that interfere with the near surface resolution of single element transducers. With a dual, the receiver element is unlikely to pick up this false echo. Finally, duals may be designed for high temperature measurements that would damage single element contact transducers.

---

## Factors Affecting Performance and Accuracy

**A. Surface Condition** - Loose or flaking scale, rust, corrosion or dirt on the outside surface of a test piece will interfere with the coupling of sound energy from the transducer into the test material. Thus, any loose debris of this sort should be cleaned from the specimen with a wire brush or file before measurements are attempted. Generally it is possible to make corrosion measurements through thin layers of rust, as long as the rust is smooth and well bonded to the metal below. Some very rough cast or corroded surfaces may have to be filed or sanded smooth in order to insure proper sound coupling. It may also be necessary to remove paint if it has been applied in thick coats, or if it is flaking off the metal. While it is often possible to make corrosion measurements through thin coats of paint (on the order of a few thousandths of an inch or 0.1 - 0.2 mm), thick paint will attenuate signals or possibly create false echoes, causing inaccurate measurements.

Severe pitting on the outside surface of a pipe or tank can be a problem. On some rough surfaces, the use of a gel or grease rather than a liquid couplant will help transmit sound energy into the test piece. In extreme cases it will be necessary to file or grind the surface sufficiently flat to permit contact with the face of the transducer. In applications where deep pitting occurs on the outside of a pipe or tank it is usually necessary to measure remaining metal thickness from the base of the pits to the inside wall. There are sophisticated ultrasonic techniques utilizing focused immersion transducers that can measure directly from the base of the pit to the inside wall, but this is generally not practical for field work. The conventional technique is to measure unpitted metal thickness ultrasonically, measure pit depth mechanically, and subtract the pit depth from the measured wall thickness. Alternately, one can file or grind the surface down to the base of the pits and measure normally.

As with any difficult application, experimentation with actual product samples is the best way to determine the limits of a particular gauge/transducer combination on a given surface.

---

## Factors Affecting Performance and Accuracy (cont.)

**B. Transducer Positioning/Alignment** - For proper sound coupling the transducer must be pressed firmly against the test surface. On small diameter cylindrical surfaces such as pipes, hold the transducer so that the sound barrier material visible on the probe face is aligned perpendicular to the center axis of the pipe. See Figure C-1 below.

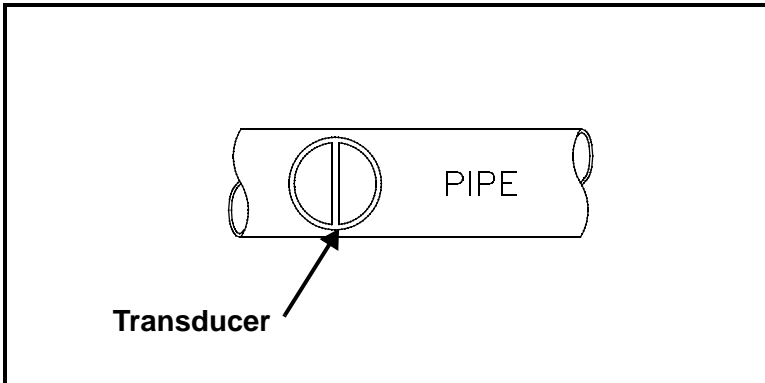

**Figure C-1: Proper Alignment of Transducers for Cylindrical Surfaces**

While firm hand pressure on the transducer is necessary for good readings, the probe should never be scraped along or twisted against a rough metal surface. This will scratch the face of the transducer and eventually degrade performance. The safest technique for moving a transducer along a rough surface is to pick it up and reposition it for each measurement, not to slide it along.

## Factors Affecting Performance and Accuracy (cont.)

Remember that an ultrasonic test measures thickness at only one point within the beam of the transducer, and that in corrosion situations wall thicknesses often vary considerably. Test procedures usually call for making a number of measurements within a defined area and establishing a minimum and/or average thickness. Ideally, data should be taken at increments no greater than half the diameter of the transducer, to insure that no pits or other local variations in wall thickness are missed. It is up to the user to define a pattern of data collection appropriate to the needs of a given application.

It is possible that on some severely corroded or pitted materials there will be spots where readings cannot be obtained. This can happen when the inside surface of the material is so irregular that the sound energy is scattered rather than being reflected back to the transducer. The lack of a reading may also indicate a thickness outside the range of the transducer and instrument being used. Generally, an inability to obtain a valid thickness reading at a particular point on a test specimen could be a sign of a seriously degraded wall which may warrant investigation by other means.

**C. Calibration** - The accuracy of measurements are only as good as the accuracy and care with which the gauge has been calibrated. It is essential that the thickness gauge be calibrated (as described on page 9-12) whenever the transducer is changed or you have a reason to doubt the accuracy of the readings. Periodic checks with samples of known thicknesses are recommended to verify that the gauge is operating properly.

---

## Factors Affecting Performance and Accuracy (cont.)

**D. Taper or Eccentricity** - If the contact surface and the back surface are tapered or eccentric with respect to each other, the return echo again becomes distorted and the accuracy of measurement is diminished.

**E. Acoustic Properties of the Material** - There are several conditions found in engineering materials that can severely limit the accuracy and thickness range that can be measured.

### 1. Sound Scattering

In some materials, notably certain types of cast stainless steel, cast irons, and composites, the sound energy is scattered from individual crystallites in the casting or from dissimilar materials within the composite. This effect reduces the ability to discriminate a valid return echo from the back side of the material and limits the ability to gauge the material ultrasonically.

### 2. Velocity Variations

A number of materials exhibit significant variations in sound velocity from point-to-point within the material. Certain types of cast stainless steels and brass exhibit this effect due to a relatively large grain size and the anisotropy of sound velocity with respect to grain orientation. Other materials show a rapid change in sound velocity with temperature. This is characteristic of plastic materials where temperature must be controlled in order to obtain maximum precision in the measurement.

### 3. Sound Attenuation or Absorption

In many organic materials, such as low density plastics and rubber, sound is attenuated very rapidly at the frequencies used in normal ultrasonic thickness gaging. Therefore, the maximum thickness that can be measured in these materials is often limited by sound attenuation.



## Appendix D

# Material Safety Data Sheets for Couplants

---

A variety of couplants are available for use with GE Infrastructure Sensing transducers. To obtain a material safety data sheet (MSDS) for any couplant GE Infrastructure Sensing supplies, go to the GE Infrastructure Sensing web site and enter the Technical Support portal.

# Index

## A

About Option .....	6-21
Acceleration Limit .....	9-33
Accuracy	
Thickness Gauge .....	11-8
Accuracy, Clamp-on Flow .....	11-2
ACTiSYS ACT-IR interface .....	2-4
ActiSys ACT-IR220L+ infrared adapter .....	B-1
Amplitude Discriminator Limits .....	9-33
Analog Input Calibration .....	9-21
Analog Inputs	
Connections .....	2-3
in Energy Option .....	4-37
Analog Inputs, Entering .....	4-34
Analog Output Calibration .....	9-21
Analog Output Option .....	4-39
Analog Output, Entering .....	4-39
Analog Outputs	
Connections .....	2-3
Area Classifications .....	11-6
Arrow Keys .....	2-12

## B

Backlight Option .....	7-14
Backlight, Timeout for .....	7-14
Bar Graph Display .....	6-4
Batteries	
Charge .....	2-5
Charging .....	2-5
Replacing .....	2-6
Battery Charger .....	7-5, 7-6
Battery Charger Input .....	11-4
Battery Option .....	7-5
Battery Test Option .....	9-41
Battery, Internal	
Specifications .....	11-4
Battery, Testing .....	9-41

## Index (cont.)

### C

Calibration	
Analog Input .....	9-21
Analog Output .....	9-21
Calibration Factor, Entering a .....	4-53
Capturing Signals .....	9-40
Checks	
Power Up .....	2-7
Clamping Fixture, Installing .....	3-9
Clamp-On Transducers	
Path Parameters for .....	4-16
Clamp-on Transducers	
Installing .....	3-1
Clearing Softkey .....	6-13
Communications Option .....	7-15
Menu Map .....	A-11
Configuring the display .....	6-1
Connections .....	2-2
Analog Inputs .....	2-3
Analog Outputs .....	2-3
Power .....	2-2
Transducers .....	2-3
Contrast Option .....	7-12
Contrast, Adjusting .....	7-12
Correction Factors Option .....	4-50
Correction Factors, Entering .....	4-50
Couplant .....	11-6
Couplant, using .....	3-11, 3-18, 3-29
Customizing Softkeys .....	6-11

## Index (cont.)

### D

Dampening Material .....	3-20
Data Acquisition .....	1-4
Data Logging .....	11-5
Data Sources, Changing .....	6-7, 6-8
Date and Time Options .....	7-9
Date, Entering .....	7-7
Date/Time Format, Changing .....	7-9
Defaults, Resetting to .....	9-42
Delta-T Offset .....	9-26
Description	
Electronics .....	1-4
Error Messages .....	10-2
Flowcell .....	1-3
Keypad .....	2-12
Keys .....	2-12
Screen .....	2-10
System .....	1-3
Detection Threshold .....	9-19
Diagnostic Parameters, Displaying .....	9-20
Diagnostics .....	10-1, 10-6
Error Messages .....	10-2
Diagnostics Option .....	9-20
Digital Interfaces .....	11-5
Digital Output Option .....	4-42
Dimensions .....	11-4
DIN Schedule, Applying .....	4-10
Display .....	11-4
Screen .....	2-10
Display Functions .....	11-5
Display Options .....	7-9
Display Screen, Configuring .....	6-9
Displaying Data as Graph .....	6-4
Displaying Details .....	8-18
Drive Manager .....	6-14

## Index (cont.)

### E

Electrical	
Connections .....	2-2
Electrical Connections .....	2-2
Electronics .....	11-4
Connections .....	2-2
Description .....	1-4
Error Messages .....	10-2
Theory of Operation .....	1-5
Enclosures .....	11-4
English Units .....	7-3
ENT Key .....	2-12
Error Limits Option .....	9-32
Error Messages .....	10-2
Battery .....	2-5
Errors Allowed .....	9-27
European Compliance	
Specifications .....	11-5
EXIT Key .....	2-12

### F

Factory Defaults Option .....	9-42
Feature Keys .....	2-12
File	
Transferring to PC .....	6-16, 6-17
File Manager	
Sort Menu .....	6-20
File Menu	
in Log Manager .....	8-4
File, Transferring from PC .....	5-15, 6-17, 6-18
Fixture Materials .....	11-6
Flash Update .....	9-43
Flash Update Option .....	9-44, 9-47
Flow Measurement .....	11-4
Flowcell .....	1-3
Description .....	1-3
Flowcell Piping .....	1-3
Fluid Option .....	4-13
Fluid Problems	
Flowcell Problems .....	10-9
Fluid Speeds, Entering .....	4-13
Fluid Types .....	11-2
Fluid Types, Entering .....	4-13
Format Option .....	6-2
Forward Total, Resetting .....	7-18

## Index (cont.)

### G

Graph Display ..... 6-4

### H

Help ..... 2-14

Hyperterminal  
for Software Update ..... 9-46

### I

Impulse Response Option ..... 9-39

Infrared Interface

IrCOMM ..... 9-43

IrOBEX ..... 9-43

Infrared Wireless Interface ..... 2-4

Initial Setup ..... 2-1

Input/Output ..... 1-4

Input/Output Connections ..... 2-3

Inputs

Analog Inputs ..... 2-3

Analog, Entering ..... 4-34

in Standard Volume Option ..... 4-19

Inputs/Outputs

Specifications ..... 11-5

Installation Requirements

Minimum Pressure ..... 3-4

IR Communications

Changing Parameters ..... 7-15

Establishing with PT878GC ..... B-1

IrCOMM ..... 9-43

Updating Software with ..... 9-46

IrOBEX ..... 9-43

Updating Software with ..... 9-44

### K

Keypad

Description ..... 2-12

Key Description ..... 2-12

Specifications ..... 11-4

Keys

Description ..... 2-12

Kinematic Viscosity, Entering ..... 4-51

## Index (cont.)

### L

Limits Option .....	6-5
Line Graph Display .....	6-4
Lining Parameters, Entering .....	4-11
Listing Files	
By Date .....	5-17
by Date .....	6-20
By Name .....	5-17
by Name .....	6-20
Listing Logs	
by Date .....	8-23
by Name .....	8-23
Locale Option .....	7-9
Log .....	8-18
Copying a .....	8-10
Deleting a .....	8-11
Ending a .....	8-15
in Graph Form .....	8-19, 8-20, 8-21
in Spreadsheet Format .....	8-22
Printing .....	8-13
Renaming a .....	8-11
Restarting .....	8-15
Stopping a .....	8-15
Transferring to PC .....	8-13
Log Manager .....	8-3
Sort Menu .....	8-23
Log Menu	
in Log Manager .....	8-14
Log, Creating a .....	8-5
Logging Menu	
Menu Map .....	A-9
Logging Menu, Entering .....	8-2
Logs	
Deleting All .....	8-12
Ending All .....	8-16
Stopping All .....	8-16
Low Signal Threshold .....	9-18

## Index (cont.)

### M

M>S Switch .....	4-25
Main Menu	
Menu Map .....	A-1
Mass Flow .....	4-17
Material	
in Thickness Gauge Setup Option .....	9-7
Maximum Flow Velocity .....	3-4
Measurement Mode .....	9-28
Measurement Option .....	6-7, 6-8
Measurement Parameters .....	11-3
Measurement Parameters, Changing .....	6-7, 6-8
Measurement Units, Selecting .....	7-3
Memory	
Specifications .....	11-4
Meter Menu	
Menu Map .....	A-8
Meter Menu, Entering .....	7-2
Meter Settings Window .....	7-3
Metric Units .....	7-3
Microcomputer .....	1-4
Model number .....	6-21
Mountings .....	11-6

### N

Node ID for Communications .....	7-15
Noise Threshold .....	9-18
Numeric Keys .....	2-12

### O

On-Line Help .....	2-14
Getting .....	2-14
Operation and Performance	
Specifications .....	11-2
Options .....	11-8
PC Communications .....	11-8
RS232-to-Infrared .....	11-8
Thickness Gauge .....	11-8
Output	
Analog, Entering .....	4-39
Digital, Entering .....	4-42
Outputs	
Analog Outputs .....	2-3



## Index (cont.)

### P

Parameters, Displayed .....	6-10
Path	
for Clamp-on .....	4-16
Path Option .....	4-15
PC Communication .....	11-8
PC File Transfer .....	5-15, 6-17, 6-18
PI Fixture, Installing .....	3-13
Pipe Diameter, Entering .....	4-9
Pipe Lining, Entering .....	4-11
Pipe Material .....	4-8
Pipe Materials .....	11-2
for Thickness Gauge .....	11-8
Pipe Option	
Menu Map .....	A-3
Pipe Problems .....	10-10
Pipe Sizes .....	11-2
Pipe Thickness Range	
for Thickness Gauge .....	11-8
Pipe Wall Thickness .....	11-2
Power	
Connections .....	2-2
Turn On and Off .....	2-7
Power Connections .....	2-2
Powering On/Off .....	2-7
Pressure Requirements .....	3-4
Pressure Requirements, Air .....	11-3
Pressure Requirements, Other Gases .....	11-3
Printer .....	11-8
Printer Specifications .....	11-8
Printing a Log .....	8-13
Problems	
Flowcell .....	10-9
Fluid .....	10-9
Pipe .....	10-10
Transducers .....	10-11
Program Menu .....	4-1
Menu Map .....	A-3
PT878GC	
Features of .....	1-1
Keypad .....	2-12
Powering On/Off .....	2-7
Screen .....	2-10
PT878GC Bootloader .....	9-43

## Index (cont.)

### R

Range.....	11-2
Rangeability.....	11-2
Receiver.....	1-4
Repeatability.....	11-2
Reports Option.....	9-3, 9-4
Reports, Printing.....	9-3, 9-4
Return Policy.....	iv
Reverse Total, Resetting.....	7-18
Reynolds Correction, Entering.....	4-50
RS232-to-Infrared.....	11-8

## Index (cont.)

### S

Sampling Waves.....	9-40
Schedule for Pipe Dimensions.....	4-9
Screen	
Description.....	2-10
On-Line Help.....	2-14
Service Menu	
Menu Map.....	A-10
Service Menu, Entering.....	9-2
Setting up PC for Flash Update.....	9-46
Signal Inversion.....	9-18, 9-31
Signal Parameters, Setting up.....	9-25
Signal Path, Entering.....	4-15
Signal Setup Option.....	9-25
Signal, Applying a Stored.....	9-40
Signals, Capturing.....	9-40
Simulate Option.....	9-40
Site	
Deleting a.....	5-10
Renaming a.....	5-9
Saving a.....	5-7
Saving with Different Name.....	5-8
Transferring to PC.....	5-13, 5-14
Site Manager.....	5-2
Sort Menu.....	5-17
Site Menu.....	5-1
Site Parameter Programming.....	11-5
Site, Creating a New.....	5-4
Site, Open a.....	5-6
Skam/Correlate.....	9-28
Skam/Count.....	9-28
Skam/Integrate.....	9-28
Skam/Measure.....	9-28
Skam-T Offset.....	4-25
Softkey, Clearing a.....	6-13
Softkeys, Customizing.....	6-11
Software	
Bootloader.....	9-43
FPGA.....	9-43
Updating.....	9-43
Software version.....	6-21
Sort Menu	
in File Manager.....	6-20
in Log Manager.....	8-23
in Site Manager.....	5-17
Sound Speed Limits.....	9-33

## Index (cont.)

Sound Speed, Calculating .....	9-14, 9-15
Span (Full Scale) Value	
for Analog Output .....	4-41
Special Transducers	
Entering Data .....	4-5
Specifications	
Clamp-on Flow Accuracy .....	11-2
Dimensions .....	11-4
Electronics .....	11-4
European Compliance .....	11-5
Fluid Type .....	11-2
Inputs/Outputs .....	11-5
Internal Battery .....	11-4
Keypad .....	11-4
Memory .....	11-4
Operations .....	11-2
Pipe Materials .....	11-2
Pipe Size .....	11-2
Pipe Wall Thickness .....	11-2
Pressure Requirements, Air .....	11-3
Pressure Requirements, Other Gases .....	11-3
Range .....	11-2
Rangeability .....	11-2
Repeatability .....	11-2
Thickness Gauge .....	11-8
Transducers .....	11-6
Standard Volume Option	
Entering Inputs .....	4-19
Entering Parameters .....	4-17
Static Density .....	4-17
Stopwatch Totalizer .....	2-11, 4-45
System	
Description .....	1-3

## Index (cont.)

### T

Task Keys .....	2-12
Temperature .....	
Operating .....	11-4
Storage .....	11-4
Temperature Ranges .....	
Transducers .....	11-6
Test Keys .....	9-37
Test Screen .....	9-36
Testing Timer Circuit .....	9-38
Theory of Operation .....	1-5
Thermal Exposure .....	11-8
Thickness .....	
Calibrating .....	9-12, 9-13
Displaying in Graphical Format .....	9-10, 9-11
Displaying in Numeric Format .....	9-9
Thickness Gage .....	
Theory of Operation .....	C-1
Thickness Gauge .....	
Calibrating .....	9-12, 9-13
Entering Programming Data .....	9-17
Low Signal Threshold .....	9-18
Setup .....	9-5, 9-6
Sound Speed .....	9-14, 9-15
Specifications .....	11-8
Thermal Exposure .....	11-8
Thickness Gauge Setup .....	9-18
Detection Threshold .....	9-19
Signal Inversion .....	9-18, 9-31
Transducer Delay .....	9-18
Time Delay, Entering .....	4-5
Time, Entering .....	7-7
Timing Circuit .....	1-4
Totals, Resetting .....	7-18
Transducer Connections .....	2-3
Transducer Delay .....	9-18
Transducer Number, Entering .....	4-4
Transducer Option .....	4-3
Transducer Signal Limits .....	9-32
Transducer Spacing, Entering .....	4-16
TRANSDUCERS .....	1-3
Transducers .....	1-3
Area Classifications .....	11-6
Cables .....	11-7
Clamp-on .....	3-1
Connections .....	2-3

## Index (cont.)

Entering Data for .....	4-3
Materials .....	11-6
Mountings .....	11-6
Problems .....	10-11
Special .....	4-5
Specifications .....	11-6
Temperature Ranges .....	11-6
Thickness Gauge .....	11-8
Wetted or clamp-on .....	4-3
Transfer	
Log .....	8-13
Transit-Time, Theory of .....	1-5
Transmit Signal Generator .....	1-4
Transmitter .....	1-4
Transmitter Sample Size .....	9-26
Traverses, Entering Number .....	4-16
Troubleshooting .....	10-1
Error Messages .....	10-2
Turning On/Off .....	2-7
Tw (time delay) .....	4-5

## U

Units Option .....	7-3
User Functions Option .....	4-46
User Functions, Entering .....	4-46
User Table Option .....	7-19
User Tables, Creating .....	7-19

## V

V4 and V8 Clamping Fixture, Installing .....	3-9
Velocity Averaging .....	9-27
Velocity Limits .....	9-33
View All Sites Option .....	8-16
View Menu	
in Log Manager .....	8-17
View Option .....	6-4

## Index (cont.)

### W

Warranty .....	iii
Watchdog Test .....	9-38
Wave Sampling.....	9-40
Wave Snapshot Option .....	9-40
Wedge Angle, Entering.....	4-5
Wedge Sound Speed, Entering .....	4-6
Wedge Temperature, Entering.....	4-5
Windows Operating Systems	
Compatibility with IR .....	B-1

### Z

Zero (Base) Value	
for Analog Output.....	4-41
Zero Cutoff .....	9-26

We, **Panametrics Limited**  
**Shannon Industrial Estate**  
**Shannon, County Clare**  
**Ireland**

declare under our sole responsibility that the

**TransPort™ PT878 Portable Ultrasonic Flowmeter**  
**TransPort™ PT878GC Clamp-On Portable Ultrasonic Flowmeter**  
**TransPort™ 2PT868 2-Channel Portable Ultrasonic Flowmeter**  
**TransPort™ PT868 Portable Ultrasonic Flowmeter**  
**TransPort™ PT868-L Portable Ultrasonic Flowmeter**  
**TransPort™ PT868-R Portable Ultrasonic Flowmeter with TransFlection™ Mode**

to which this declaration relates, are in conformity with the following standards:

- EN 61326:1998, Class A, Annex C, Continuous Unmonitored Operation

following the provisions of the 89/336/EEC EMC Directive.

*The units listed above and any transducers supplied with them (spoolpieces are addressed under a separate declaration of conformity) do not bear CE marking for the Pressure Equipment Directive, as they are supplied in accordance with Article 3, Section 3 (sound engineering practices and codes of good workmanship) of the Pressure Equipment Directive 97/23/EC for DN<25.*

Shannon - June 1, 2002

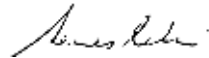

Mr. James Gibson  
GENERAL MANAGER



CERT-DOC-H5



August 2004)



Nous,

Panametrics Limited  
Shannon Industrial Estate  
Shannon, County Clare  
Ireland

déclarons sous notre propre responsabilité que les

**TransPort™ PT878 Portable Ultrasonic Flowmeter**  
**TransPort™ PT878GC Clamp-On Portable Ultrasonic Flowmeter**  
**TransPort™ 2PT868 2-Channel Portable Ultrasonic Flowmeter**  
**TransPort™ PT868 Portable Ultrasonic Flowmeter**  
**TransPort™ PT868-L Portable Ultrasonic Flowmeter**  
**TransPort™ PT868-R Portable Ultrasonic Flowmeter with TransFlection™ Mode**

relatif à cette déclaration, sont en conformité avec les documents suivants:

- EN 61326:1998, Class A, Annex C, Continuous Unmonitored Operation

suivant les règles de la Directive de Compatibilité Electromagnétique 89/336/EEC.

*Les matériels listés ci-dessus ainsi que les transducteurs pouvant être livrés avec (les manchettes faisant l'objet d'une déclaration de conformité séparée) ne portent pas le marquage CE de la directive des équipements sous pression, car ils sont fournis en accord avec la directive 97/23/EC des équipements sous pression pour les DN<25, Article 3, section 3 qui concerne les pratiques et les codes de bonne fabrication pour l'ingénierie du son.*

Shannon - June 1, 2002

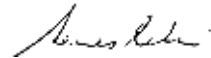

Mr. James Gibson  
DIRECTEUR GÉNÉRAL



CERT-DOC-H5



August 2004)

Wir,

Panametrics Limited  
Shannon Industrial Estate  
Shannon, County Clare  
Ireland

erklären, in alleiniger Verantwortung, daß die Produkte

TransPort™ PT878 Portable Ultrasonic Flowmeter  
TransPort™ PT878GC Clamp-On Portable Ultrasonic Flowmeter  
TransPort™ 2PT868 2-Channel Portable Ultrasonic Flowmeter  
TransPort™ PT868 Portable Ultrasonic Flowmeter  
TransPort™ PT868-L Portable Ultrasonic Flowmeter  
TransPort™ PT868-R Portable Ultrasonic Flowmeter with TransFlection™ Mode

folgende Normen erfüllen:

- EN 61326:1998, Class A, Annex C, Continuous Unmonitored Operation

gemäß den Europäischen Richtlinien, Niederspannungsrichtlinie EMV-Richtlinie  
Nr.: 89/336/EG

Die oben aufgeführten Geräte und zugehörige, mitgelieferte Schallwandler (Messrohre werden in einer separaten Konformitätserklärung behandelt) tragen keine CE-Kennzeichnung gemäß der Druckgeräte-Richtlinie, da sie in Übereinstimmung mit Artikel 3, Absatz 3 (gute Ingenieurpraxis) der Druckgeräte-Richtlinie 97/23/EG für DN<25 geliefert werden.

Shannon - June 1, 2002

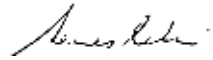

Mr. James Gibson  
GENERALDIREKTOR



CERT-DOC-H5



August 2004)



***USA***

1100 Technology Park Drive  
Billerica, MA 01821-4111  
Web: [www.gesensing.com](http://www.gesensing.com)

***Ireland***

Shannon Industrial Estate  
Shannon, County Clare  
Ireland

